

# **\*TM 5-4210-249-13&P-1**

---

## **TECHNICAL MANUAL**

### **OPERATOR'S AND FIELD LEVEL MAINTENANCE MANUAL WITH REPAIR PARTS AND SPECIAL TOOLS LIST (INCLUDING DEPOT REPAIR PARTS AND SPECIAL TOOLS)**

**FOR**

## **TACTICAL FIRE FIGHTING TRUCK (TFFT)**

**MODEL M1142**

**NSN 4210-01-486-1035**

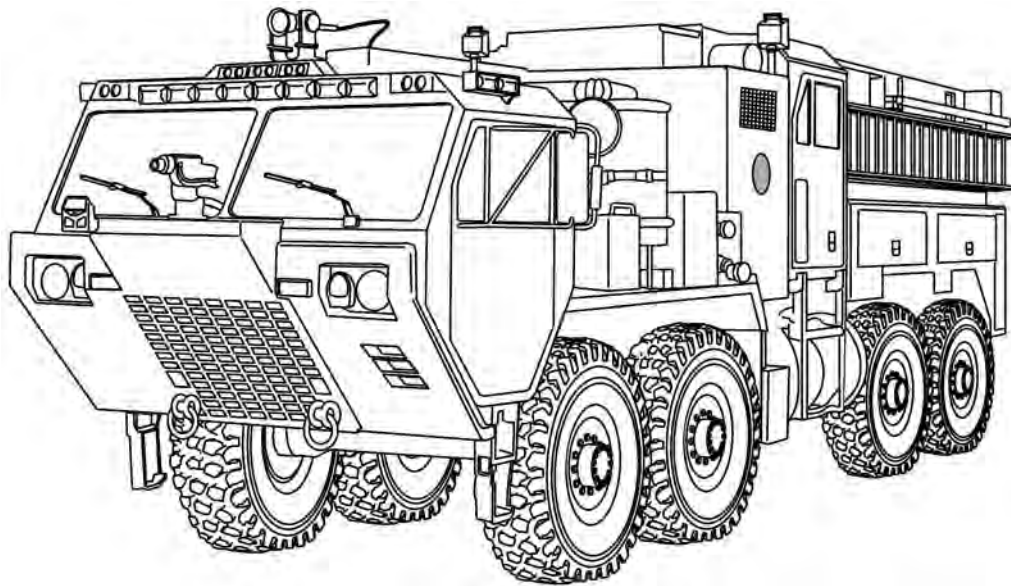

**\* SUPERSEDURE NOTICE:** This manual supersedes TM 9-2320-279-10-3 dated 15 March 2004 and TM 9-2320-315-14&P dated 15 October 2004.

**DISTRIBUTION STATEMENT A:** Approved for public release; distribution is unlimited.

---

**HEADQUARTERS, DEPARTMENT OF THE ARMY**

**FEBRUARY 2009**



## WARNING SUMMARY

---

This list summarizes critical warnings in this technical manual. They are repeated here to let you know how important they are. Study these warnings carefully. They can save your life and the lives of personnel you work with. If there is any doubt about handling tools, materials, equipment, and procedures, see TB 43-0216, Safety and Hazard Warnings for Operation and Maintenance of TACOM Equipment.

**FOR INFORMATION ON FIRST AID, REFER TO FM 4-25.11.**

### OPERATION HAZARDS

#### **WARNING**



- **CARBON MONOXIDE (EXHAUST GAS) CAN CAUSE DEATH**
- **Carbon monoxide is without color or smell, but can cause death. Breathing air with carbon monoxide produces symptoms of headache, dizziness, loss of muscular control, a sleepy feeling, and coma. Brain damage or death can result from heavy exposure. Carbon monoxide occurs in the exhaust fumes of fuel-burning heaters and internal combustion engines. Carbon monoxide can become dangerously concentrated under conditions of no ventilation. Precautions must be followed to ensure crew safety when the personnel heater or engine of any vehicle is operated for any purpose.**
- **DO NOT operate personnel heater or engine of vehicle in a closed place without proper ventilation.**
- **DO NOT drive any vehicle with inspection plates, cover plates, or engine compartment covers removed unless necessary for maintenance purposes.**
- **BE ALERT at all times during vehicle operation for exhaust odors and exposure symptoms. If either are present, IMMEDIATELY VENTILATE personnel compartments. If symptoms persist, remove affected crew to fresh air and keep warm. DO NOT PERMIT PHYSICAL EXERCISE. If necessary, give artificial respiration and get immediate medical attention. For artificial respiration, refer to FM 4-25.11.**
- **BE AWARE that the gas particulate filter unit or field protection mask for nuclear-biological-chemical protection WILL NOT offer safety from carbon monoxide poisoning.**
- **THE BEST DEFENSE AGAINST CARBON MONOXIDE POISONING IS GOOD VENTILATION.**

**WARNING**



Personnel hearing can be **PERMANENTLY DAMAGED** if exposed to constant high noise levels of 85 dB or greater. Wear approved hearing protection devices when working in high noise level areas. Hearing loss occurs gradually, but becomes permanent over time.

**MODIFICATION HAZARD**

**WARNING**



Unauthorized modifications to, alterations to, or installations of this equipment are prohibited and are in violation of AR 750-10. Any unauthorized modifications, alterations, or installations could result in injury or death to personnel or damage to equipment.

**HIGH-PRESSURE HYDRAULIC SYSTEM**

**WARNING**

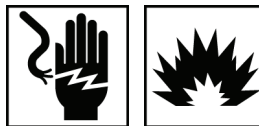

- Hydraulic systems can cause serious injury if high-pressure lines or equipment fails.
- Never work on hydraulic systems or equipment unless there is another person nearby who is familiar with the operation and hazards of the equipment and can give first aid.
- Never disconnect any hydraulic hose or part while the engine is running. Allow several minutes to elapse after shutting off engine, to allow pressure to relieve itself, before attempting to remove hoses. Failure to comply may result in injury to personnel.

**ELECTRICAL SYSTEM****WARNING**

- Remove all jewelry, such as rings, dog tags, bracelets, etc. If jewelry or tools contact electrical circuits, a direct short may result. Damage to equipment or death to personnel may occur.
- Do not smoke, use open flame, make sparks or other ignition sources around batteries. A battery giving off gas could explode and cause injury to personnel.

**SOLVENT CLEANING COMPOUND****WARNING**

Solvent cleaning compound MIL-PRF-680 Type II and III may be irritating to the eyes and skin. Use protective gloves and goggles. Use in well-ventilated areas. Use respirator as needed. Accidental ingestion can cause irritation of digestive tract and respiratory tract, may cause lung and central nervous system damage. Can be fatal if swallowed. Inhalation of high/massive concentrations can cause coma or be fatal. First aid for ingestion: do not induce vomiting. Seek immediate medical attention. First aid for skin contact: remove contaminated clothing. Wash skin thoroughly with soap and water. If symptoms persist, seek medical attention. First aid for eye contact: flush with water for 15 minutes or until irritation subsides. If symptoms persist, seek medical attention. First aid for inhalation: move to fresh air. If not breathing, provide artificial respiration. If symptoms persist, seek medical attention. Keep away from open flames and other sources of ignition. Failure to follow this warning may result in injury or death to personnel.

- The flashpoint for Type II solvent cleaning compound is 141 to 198°F (61 to 92°C) and Type III is 200 to 241°F (93 to 116°C).
- Improper cleaning methods and use of unauthorized cleaning solvents may injure personnel and damage equipment.
- Fire extinguishers should be placed nearby when using solvent cleaning compound. Failure to follow this warning may result in injury or death.
- Cloths or rags saturated with solvent cleaning compound must be disposed of IAW authorized facilities' procedures. Failure to follow this warning may result in injury.
- Eye shields must be worn when cleaning with a wire brush. Flying rust and metal particle may cause injury.

**ADHESIVE**

**WARNING**



Adhesives, solvents, and sealing compounds can burn easily, can give off harmful vapors, and are harmful to skin and clothing. To avoid injury or death, keep away from open fire and use in well-ventilated area. If adhesive, solvent, or sealing compound gets on skin or clothing, wash immediately with soap and water.

**FLAMMABLE LIQUID AND COMBUSTIBLE VAPOR**

**WARNING**



Gasoline, fuel oil, lubricating oil, grease, paint, paint thinner, cleaning solvents, and other combustible liquids present a serious fire hazard. Always store combustible liquids in approved containers and in their designated compartments or deck storage locations. Ensure exhaust and ventilation fans are operating while using cleaning solvents or paint products. Never store or charge batteries in a confined space without ventilation or near electrical equipment.

**WARNING**

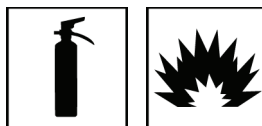

Fuel is very flammable and can explode easily. To avoid serious injury or death, keep fuel away from open fire and keep fire extinguisher within easy reach when working with fuel. Do not work on fuel system when engine is hot. Fuel can be ignited by hot engine. While working with fuel, post signs that read NO SMOKING WITHIN 50 FEET OF VEHICLE.

**PARTS UNDER PRESSURE**

**WARNING**

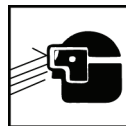

Wear safety goggles and use caution when removing or installing springs, snap rings, retaining rings, and other parts under spring tension. These parts can act as projectiles, resulting in serious injury to personnel.

## LIST OF EFFECTIVE PAGES/WORK PACKAGES

NOTE: This manual supersedes TM 9-2320-279-10-3 dated 15 March 2004 and TM 9-2320-315-14&P dated 15 October 2004. Zero in the "Change No." column indicates an original page or work package.

Date of issue for the original manual is:

Original 20 FEBRUARY 2009

**TOTAL NUMBER OF VOLUMES IS 4, TOTAL NUMBER OF PAGES  
FOR FRONT AND REAR MATTER IS 290 AND TOTAL NUMBER OF  
WORK PACKAGES IS 625, CONSISTING OF THE FOLLOWING:**

Page/WP No.	Change No.	Page/WP No.	Change No.
<b>VOLUME 1</b>		WP 0027 (6 pgs) .....	0
Cover .....	0	WP 0028 (2 pgs) .....	0
Warning Summary (4 pgs) .....	0	WP 0029 (2 pgs) .....	0
i thru xxvii. ....	0	WP 0030 (2 pgs) .....	0
xxix/(xxx blank) .....	0	WP 0031 (4 pgs) .....	0
Chp 1 Title page .....	0	WP 0032 (4 pgs) .....	0
WP 0001 (8 pgs) .....	0	WP 0033 (4 pgs) .....	0
WP 0002 (10 pgs) .....	0	WP 0034 (4 pgs) .....	0
WP 0003 (4 pgs) .....	0	WP 0035 (2 pgs) .....	0
Chp 2 Title page .....	0	WP 0036 (2 pgs) .....	0
WP 0004 (34 pgs) .....	0	WP 0037 (2 pgs) .....	0
WP 0005 (2 pgs) .....	0	WP 0038 (2 pgs) .....	0
WP 0006 (2 pgs) .....	0	WP 0039 (2 pgs) .....	0
WP 0007 (2 pgs) .....	0	WP 0040 (10 pgs) .....	0
WP 0008 (2 pgs) .....	0	WP 0041 (6 pgs) .....	0
WP 0009 (2 pgs) .....	0	WP 0042 (6 pgs) .....	0
WP 0010 (2 pgs) .....	0	WP 0043 (14 pgs) .....	0
WP 0011 (2 pgs) .....	0	WP 0044 (12 pgs) .....	0
WP 0012 (2 pgs) .....	0	WP 0045 (18 pgs) .....	0
WP 0013 (2 pgs) .....	0	WP 0046 (6 pgs) .....	0
WP 0014 (2 pgs) .....	0	WP 0047 (16 pgs) .....	0
WP 0015 (4 pgs) .....	0	Chp 3 Title page .....	0
WP 0016 (2 pgs) .....	0	WP 0048 (2 pgs) .....	0
WP 0017 (2 pgs) .....	0	WP 0049 (2 pgs) .....	0
WP 0018 (2 pgs) .....	0	WP 0050 (6 pgs) .....	0
WP 0019 (4 pgs) .....	0	WP 0051 (2 pgs) .....	0
WP 0020 (16 pgs) .....	0	WP 0052 (2 pgs) .....	0
WP 0021 (4 pgs) .....	0	WP 0053 (2 pgs) .....	0
WP 0022 (4 pgs) .....	0	WP 0054 (2 pgs) .....	0
WP 0023 (4 pgs) .....	0	WP 0055 (2 pgs) .....	0
WP 0024 (2 pgs) .....	0	WP 0056 (4 pgs) .....	0
WP 0025 (6 pgs) .....	0	WP 0057 (4 pgs) .....	0
WP 0026 (4 pgs) .....	0	WP 0058 (2 pgs) .....	0
		WP 0059 (2 pgs) .....	0

Page/WP No.	Change No.	Page/WP No.	Change No.
WP 0060 (4 pgs).....	0	WP 0109 (14 pgs).....	0
WP 0061 (2 pgs).....	0	WP 0110 (16 pgs).....	0
WP 0062 (2 pgs).....	0	WP 0111 (18 pgs).....	0
WP 0063 (2 pgs).....	0	WP 0112 (18 pgs).....	0
WP 0064 (6 pgs).....	0	WP 0113 (12 pgs).....	0
WP 0065 (4 pgs).....	0	WP 0114 (30 pgs).....	0
WP 0066 (2 pgs).....	0	WP 0115 (48 pgs).....	0
WP 0067 (2 pgs).....	0	WP 0116 (12 pgs).....	0
WP 0068 (2 pgs).....	0	WP 0117 (10 pgs).....	0
WP 0069 (2 pgs).....	0	WP 0118 (12 pgs).....	0
WP 0070 (34 pgs).....	0	WP 0119 (34 pgs).....	0
WP 0071 (2 pgs).....	0	WP 0120 (14 pgs).....	0
WP 0072 (14 pgs).....	0	WP 0121 (10 pgs).....	0
WP 0073 (12 pgs).....	0	WP 0122 (14 pgs).....	0
WP 0074 (12 pgs).....	0	WP 0123 (14 pgs).....	0
WP 0075 (8 pgs).....	0	WP 0124 (4 pgs).....	0
WP 0076 (4 pgs).....	0	WP 0125 (24 pgs).....	0
WP 0077 (10 pgs).....	0	INDEX-1 thru INDEX-38.....	0
WP 0078 (10 pgs).....	0		
WP 0079 (8 pgs).....	0	<b>VOLUME 2</b>	
WP 0080 (10 pgs).....	0	Cover.....	0
WP 0081 (2 pgs).....	0	Warning Summary (4 pgs).....	0
WP 0082 (2 pgs).....	0	i thru x.....	0
WP 0083 (2 pgs).....	0	Chp 3 Title Cont. page.....	0
WP 0084 (4 pgs).....	0	WP 0126 (14 pgs).....	0
WP 0085 (8 pgs).....	0	WP 0127 (24 pgs).....	0
WP 0086 (4 pgs).....	0	WP 0128 (6 pgs).....	0
WP 0087 (2 pgs).....	0	WP 0129 (6 pgs).....	0
WP 0088 (2 pgs).....	0	WP 0130 (48 pgs).....	0
WP 0089 (6 pgs).....	0	WP 0131 (50 pgs).....	0
WP 0090 (2 pgs).....	0	WP 0132 (6 pgs).....	0
WP 0091 (6 pgs).....	0	WP 0133 (4 pgs).....	0
WP 0092 (10 pgs).....	0	WP 0134 (6 pgs).....	0
WP 0093 (6 pgs).....	0	WP 0135 (4 pgs).....	0
WP 0094 (32 pgs).....	0	WP 0136 (4 pgs).....	0
WP 0095 (18 pgs).....	0	WP 0137 (10 pgs).....	0
WP 0096 (18 pgs).....	0	WP 0138 (14 pgs).....	0
WP 0097 (16 pgs).....	0	WP 0139 (8 pgs).....	0
WP 0098 (16 pgs).....	0	WP 0140 (4 pgs).....	0
WP 0099 (16 pgs).....	0	WP 0141 (6 pgs).....	0
WP 0100 (6 pgs).....	0	WP 0142 (4 pgs).....	0
WP 0101 (16 pgs).....	0	WP 0143 (4 pgs).....	0
WP 0102 (12 pgs).....	0	WP 0144 (6 pgs).....	0
WP 0103 (12 pgs).....	0	WP 0145 (6 pgs).....	0
WP 0104 (52 pgs).....	0	WP 0146 (12 pgs).....	0
WP 0105 (30 pgs).....	0	WP 0147 (6 pgs).....	0
WP 0106 (12 pgs).....	0	WP 0148 (2 pgs).....	0
WP 0107 (18 pgs).....	0	WP 0149 (10 pgs).....	0
WP 0108 (18 pgs).....	0		



Page/WP No.	Change No.	Page/WP No.	Change No.
WP 0150 (14 pgs)	0	WP 0197 (2 pgs)	0
WP 0151 (6 pgs)	0	WP 0198 (2 pgs)	0
WP 0152 (26 pgs)	0	WP 0199 (4 pgs)	0
WP 0153 (12 pgs)	0	WP 0200 (8 pgs)	0
WP 0154 (18 pgs)	0	WP 0201 (14 pgs)	0
WP 0155 (26 pgs)	0	WP 0202 (6 pgs)	0
WP 0156 (34 pgs)	0	WP 0203 (4 pgs)	0
WP 0157 (14 pgs)	0	WP 0204 (2 pgs)	0
WP 0158 (22 pgs)	0	WP 0205 (2 pgs)	0
WP 0159 (14 pgs)	0	WP 0206 (2 pgs)	0
WP 0160 (12 pgs)	0	WP 0207 (4 pgs)	0
WP 0161 (10 pgs)	0	WP 0208 (8 pgs)	0
WP 0162 (16 pgs)	0	WP 0209 (8 pgs)	0
WP 0163 (8 pgs)	0	WP 0210 (8 pgs)	0
WP 0164 (6 pgs)	0	WP 0211 (6 pgs)	0
WP 0165 (18 pgs)	0	WP 0212 (2 pgs)	0
WP 0166 (12 pgs)	0	WP 0213 (2 pgs)	0
WP 0167 (8 pgs)	0	WP 0214 (6 pgs)	0
WP 0168 (26 pgs)	0	WP 0215 (10 pgs)	0
WP 0169 (8 pgs)	0	WP 0216 (4 pgs)	0
WP 0170 (6 pgs)	0	WP 0217 (14 pgs)	0
WP 0171 (24 pgs)	0	WP 0218 (6 pgs)	0
WP 0172 (4 pgs)	0	WP 0219 (50 pgs)	0
WP 0173 (32 pgs)	0	WP 0220 (6 pgs)	0
WP 0174 (16 pgs)	0	WP 0221 (8 pgs)	0
WP 0175 (10 pgs)	0	WP 0222 (2 pgs)	0
WP 0176 (16 pgs)	0	WP 0223 (4 pgs)	0
WP 0177 (14 pgs)	0	WP 0224 (4 pgs)	0
WP 0178 (12 pgs)	0	WP 0225 (4 pgs)	0
WP 0179 (6 pgs)	0	WP 0226 (2 pgs)	0
WP 0180 (6 pgs)	0	WP 0227 (2 pgs)	0
WP 0181 (8 pgs)	0	WP 0228 (4 pgs)	0
WP 0182 (26 pgs)	0	WP 0229 (2 pgs)	0
WP 0183 (22 pgs)	0	WP 0230 (4 pgs)	0
WP 0184 (14 pgs)	0	WP 0231 (4 pgs)	0
Chp 4 Title page	0	WP 0232 (4 pgs)	0
WP 0185 (6 pgs)	0	WP 0233 (6 pgs)	0
WP 0186 (38 pgs)	0	WP 0234 (8 pgs)	0
Chp 5 Title page	0	WP 0235 (4 pgs)	0
WP 0187 (12 pgs)	0	WP 0236 (4 pgs)	0
WP 0188 (6 pgs)	0	WP 0237 (4 pgs)	0
WP 0189 (2 pgs)	0	WP 0238 (6 pgs)	0
WP 0190 (2 pgs)	0	WP 0239 (2 pgs)	0
WP 0191 (4 pgs)	0	WP 0240 (4 pgs)	0
WP 0192 (2 pgs)	0	WP 0241 (4 pgs)	0
WP 0193 (6 pgs)	0	WP 0242 (2 pgs)	0
WP 0194 (4 pgs)	0	WP 0243 (4 pgs)	0
WP 0195 (2 pgs)	0	WP 0244 (2 pgs)	0
WP 0196 (8 pgs)	0	WP 0245 (2 pgs)	0

Page/WP No.	Change No.	Page/WP No.	Change No.
WP 0246 (4 pgs).....	0	<b>VOLUME 3</b>	
WP 0247 (4 pgs).....	0	Cover.....	0
WP 0248 (6 pgs).....	0	Warning Summary (4 pgs).....	0
WP 0249 (4 pgs).....	0	i thru xii.....	0
WP 0250 (4 pgs).....	0	xiii/(xiv blank).....	0
WP 0251 (6 pgs).....	0	Chp 5 Title Cont. page.....	0
WP 0252 (4 pgs).....	0	WP 0294 (4 pgs).....	0
WP 0253 (2 pgs).....	0	WP 0295 (2 pgs).....	0
WP 0254 (4 pgs).....	0	WP 0296 (2 pgs).....	0
WP 0255 (36 pgs).....	0	WP 0297 (2 pgs).....	0
WP 0256 (4 pgs).....	0	WP 0298 (10 pgs).....	0
WP 0257 (2 pgs).....	0	WP 0299 (2 pgs).....	0
WP 0258 (4 pgs).....	0	WP 0300 (4 pgs).....	0
WP 0259 (4 pgs).....	0	WP 0301 (18 pgs).....	0
WP 0260 (2 pgs).....	0	WP 0302 (4 pgs).....	0
WP 0261 (2 pgs).....	0	WP 0303 (6 pgs).....	0
WP 0262 (4 pgs).....	0	WP 0304 (8 pgs).....	0
WP 0263 (4 pgs).....	0	WP 0305 (2 pgs).....	0
WP 0264 (2 pgs).....	0	WP 0306 (2 pgs).....	0
WP 0265 (4 pgs).....	0	WP 0307 (2 pgs).....	0
WP 0266 (6 pgs).....	0	WP 0308 (2 pgs).....	0
WP 0267 (8 pgs).....	0	WP 0309 (2 pgs).....	0
WP 0268 (6 pgs).....	0	WP 0310 (4 pgs).....	0
WP 0269 (2 pgs).....	0	WP 0311 (14 pgs).....	0
WP 0270 (6 pgs).....	0	WP 0312 (8 pgs).....	0
WP 0271 (6 pgs).....	0	WP 0313 (2 pgs).....	0
WP 0272 (8 pgs).....	0	WP 0314 (4 pgs).....	0
WP 0273 (4 pgs).....	0	WP 0315 (2 pgs).....	0
WP 0274 (6 pgs).....	0	WP 0316 (2 pgs).....	0
WP 0275 (6 pgs).....	0	WP 0317 (4 pgs).....	0
WP 0276 (6 pgs).....	0	WP 0318 (2 pgs).....	0
WP 0277 (6 pgs).....	0	WP 0319 (2 pgs).....	0
WP 0278 (6 pgs).....	0	WP 0320 (4 pgs).....	0
WP 0279 (4 pgs).....	0	WP 0321 (2 pgs).....	0
WP 0280 (2 pgs).....	0	WP 0322 (2 pgs).....	0
WP 0281 (2 pgs).....	0	WP 0323 (2 pgs).....	0
WP 0282 (2 pgs).....	0	WP 0324 (2 pgs).....	0
WP 0283 (2 pgs).....	0	WP 0325 (4 pgs).....	0
WP 0284 (2 pgs).....	0	WP 0326 (2 pgs).....	0
WP 0285 (2 pgs).....	0	WP 0327 (2 pgs).....	0
WP 0286 (2 pgs).....	0	WP 0328 (2 pgs).....	0
WP 0287 (2 pgs).....	0	WP 0329 (2 pgs).....	0
WP 0288 (6 pgs).....	0	WP 0330 (2 pgs).....	0
WP 0289 (2 pgs).....	0	WP 0331 (2 pgs).....	0
WP 0290 (2 pgs).....	0	WP 0332 (2 pgs).....	0
WP 0291 (2 pgs).....	0	WP 0333 (2 pgs).....	0
WP 0292 (4 pgs).....	0	WP 0334 (6 pgs).....	0
WP 0293 (4 pgs).....	0	WP 0335 (4 pgs).....	0
INDEX-1 thru INDEX-38.....	0		

Page/WP No.	Change No.	Page/WP No.	Change No.
WP 0336 (8 pgs)	0	WP 0385 (2 pgs)	0
WP 0337 (2 pgs)	0	WP 0386 (4 pgs)	0
WP 0338 (2 pgs)	0	WP 0387 (2 pgs)	0
WP 0339 (2 pgs)	0	WP 0388 (4 pgs)	0
WP 0340 (2 pgs)	0	WP 0389 (4 pgs)	0
WP 0341 (2 pgs)	0	WP 0390 (2 pgs)	0
WP 0342 (4 pgs)	0	WP 0391 (2 pgs)	0
WP 0343 (2 pgs)	0	WP 0392 (4 pgs)	0
WP 0344 (6 pgs)	0	WP 0393 (6 pgs)	0
WP 0345 (4 pgs)	0	WP 0394 (2 pgs)	0
WP 0346 (4 pgs)	0	WP 0395 (6 pgs)	0
WP 0347 (2 pgs)	0	WP 0396 (2 pgs)	0
WP 0348 (2 pgs)	0	WP 0397 (4 pgs)	0
WP 0349 (2 pgs)	0	WP 0398 (2 pgs)	0
WP 0350 (6 pgs)	0	WP 0399 (2 pgs)	0
WP 0351 (2 pgs)	0	WP 0400 (6 pgs)	0
WP 0352 (8 pgs)	0	WP 0401 (2 pgs)	0
WP 0353 (2 pgs)	0	WP 0402 (2 pgs)	0
WP 0354 (4 pgs)	0	WP 0403 (4 pgs)	0
WP 0355 (2 pgs)	0	WP 0404 (4 pgs)	0
WP 0356 (2 pgs)	0	WP 0405 (2 pgs)	0
WP 0357 (2 pgs)	0	WP 0406 (4 pgs)	0
WP 0358 (6 pgs)	0	WP 0407 (2 pgs)	0
WP 0359 (4 pgs)	0	WP 0408 (4 pgs)	0
WP 0360 (4 pgs)	0	WP 0409 (4 pgs)	0
WP 0361 (4 pgs)	0	WP 0410 (2 pgs)	0
WP 0362 (8 pgs)	0	WP 0411 (2 pgs)	0
WP 0363 (4 pgs)	0	WP 0412 (2 pgs)	0
WP 0364 (6 pgs)	0	WP 0413 (2 pgs)	0
WP 0365 (6 pgs)	0	WP 0414 (2 pgs)	0
WP 0366 (4 pgs)	0	WP 0415 (6 pgs)	0
WP 0367 (4 pgs)	0	WP 0416 (2 pgs)	0
WP 0368 (8 pgs)	0	WP 0417 (2 pgs)	0
WP 0369 (2 pgs)	0	WP 0418 (2 pgs)	0
WP 0370 (8 pgs)	0	WP 0419 (2 pgs)	0
WP 0371 (6 pgs)	0	WP 0420 (4 pgs)	0
WP 0372 (4 pgs)	0	WP 0421 (2 pgs)	0
WP 0373 (4 pgs)	0	WP 0422 (2 pgs)	0
WP 0374 (2 pgs)	0	WP 0423 (4 pgs)	0
WP 0375 (2 pgs)	0	WP 0424 (6 pgs)	0
WP 0376 (6 pgs)	0	WP 0425 (4 pgs)	0
WP 0377 (4 pgs)	0	WP 0426 (2 pgs)	0
WP 0378 (2 pgs)	0	WP 0427 (8 pgs)	0
WP 0379 (2 pgs)	0	WP 0428 (4 pgs)	0
WP 0380 (2 pgs)	0	WP 0429 (4 pgs)	0
WP 0381 (8 pgs)	0	WP 0430 (4 pgs)	0
WP 0382 (4 pgs)	0	WP 0431 (2 pgs)	0
WP 0383 (4 pgs)	0	WP 0432 (4 pgs)	0
WP 0384 (4 pgs)	0	WP 0433 (12 pgs)	0

**TM 5-4210-249-13&P-1**

<b>Page/WP No.</b>	<b>Change No.</b>	<b>Page/WP No.</b>	<b>Change No.</b>
WP 0434 (10 pgs).....	0	WP 0483 (4 pgs).....	0
WP 0435 (10 pgs).....	0	WP 0484 (4 pgs).....	0
WP 0436 (18 pgs).....	0	WP 0485 (6 pgs).....	0
WP 0437 (6 pgs).....	0	WP 0486 (6 pgs).....	0
WP 0438 (4 pgs).....	0	WP 0487 (4 pgs).....	0
WP 0439 (4 pgs).....	0	WP 0488 (4 pgs).....	0
WP 0440 (14 pgs).....	0	WP 0489 (2 pgs).....	0
WP 0441 (12 pgs).....	0	WP 0490 (20 pgs).....	0
WP 0442 (6 pgs).....	0	WP 0491 (4 pgs).....	0
WP 0443 (14 pgs).....	0	WP 0492 (4 pgs).....	0
WP 0444 (4 pgs).....	0	WP 0493 (4 pgs).....	0
WP 0445 (4 pgs).....	0	WP 0494 (4 pgs).....	0
WP 0446 (12 pgs).....	0	WP 0495 (4 pgs).....	0
WP 0447 (4 pgs).....	0	WP 0496 (4 pgs).....	0
WP 0448 (24 pgs).....	0	WP 0497 (6 pgs).....	0
WP 0449 (6 pgs).....	0	WP 0498 (2 pgs).....	0
WP 0450 (6 pgs).....	0	WP 0499 (2 pgs).....	0
WP 0451 (4 pgs).....	0	WP 0500 (20 pgs).....	0
WP 0452 (4 pgs).....	0	WP 0501 (2 pgs).....	0
WP 0453 (4 pgs).....	0	WP 0502 (6 pgs).....	0
WP 0454 (4 pgs).....	0	WP 0503 (4 pgs).....	0
WP 0455 (36 pgs).....	0	WP 0504 (8 pgs).....	0
WP 0456 (24 pgs).....	0	WP 0505 (4 pgs).....	0
WP 0457 (6 pgs).....	0	WP 0506 (4 pgs).....	0
WP 0458 (20 pgs).....	0	WP 0507 (4 pgs).....	0
WP 0459 (38 pgs).....	0	WP 0508 (2 pgs).....	0
WP 0460 (4 pgs).....	0	WP 0509 (6 pgs).....	0
WP 0461 (8 pgs).....	0	WP 0510 (6 pgs).....	0
WP 0462 (4 pgs).....	0	WP 0511 (2 pgs).....	0
WP 0463 (8 pgs).....	0	WP 0512 (4 pgs).....	0
WP 0464 (14 pgs).....	0	WP 0513 (8 pgs).....	0
WP 0465 (8 pgs).....	0	WP 0514 (6 pgs).....	0
WP 0466 (4 pgs).....	0	WP 0515 (2 pgs).....	0
WP 0467 (4 pgs).....	0	WP 0516 (2 pgs).....	0
WP 0468 (12 pgs).....	0	WP 0517 (4 pgs).....	0
WP 0469 (4 pgs).....	0	WP 0518 (4 pgs).....	0
WP 0470 (4 pgs).....	0	WP 0519 (10 pgs).....	0
WP 0471 (6 pgs).....	0	WP 0520 (2 pgs).....	0
WP 0472 (4 pgs).....	0	WP 0521 (12 pgs).....	0
WP 0473 (2 pgs).....	0	WP 0522 (2 pgs).....	0
WP 0474 (2 pgs).....	0	WP 0523 (2 pgs).....	0
WP 0475 (2 pgs).....	0	WP 0524 (14 pgs).....	0
WP 0476 (4 pgs).....	0	WP 0525 (4 pgs).....	0
WP 0477 (4 pgs).....	0	WP 0526 (2 pgs).....	0
WP 0478 (2 pgs).....	0	WP 0527 (28 pgs).....	0
WP 0479 (4 pgs).....	0	WP 0528 (4 pgs).....	0
WP 0480 (2 pgs).....	0	WP 0529 (2 pgs).....	0
WP 0481 (6 pgs).....	0	WP 0530 (4 pgs).....	0
WP 0482 (8 pgs).....	0	WP 0531 (4 pgs).....	0

Page/WP No.	Change No.	Page/WP No.	Change No.
WP 0532 (6 pgs)	0	WP 0572 (6 pgs)	0
WP 0533 (6 pgs)	0	WP 0573 (6 pgs)	0
WP 0534 (2 pgs)	0	WP 0574 (2 pgs)	0
WP 0535 (8 pgs)	0	WP 0575 (8 pgs)	0
WP 0536 (2 pgs)	0	WP 0576 (4 pgs)	0
WP 0537 (6 pgs)	0	WP 0577 (6 pgs)	0
WP 0538 (4 pgs)	0	WP 0578 (4 pgs)	0
WP 0539 (4 pgs)	0	WP 0579 (14 pgs)	0
WP 0540 (30 pgs)	0	WP 0580 (2 pgs)	0
WP 0541 (6 pgs)	0	WP 0581 (34 pgs)	0
WP 0542 (4 pgs)	0	WP 0582 (6 pgs)	0
WP 0543 (12 pgs)	0	WP 0583 (8 pgs)	0
WP 0544 (8 pgs)	0	WP 0584 (2 pgs)	0
WP 0545 (8 pgs)	0	WP 0585 (6 pgs)	0
WP 0546 (2 pgs)	0	WP 0586 (4 pgs)	0
WP 0547 (12 pgs)	0	WP 0587 (2 pgs)	0
WP 0548 (4 pgs)	0	WP 0588 (2 pgs)	0
WP 0549 (4 pgs)	0	WP 0589 (2 pgs)	0
WP 0550 (4 pgs)	0	WP 0590 (4 pgs)	0
WP 0551 (6 pgs)	0	WP 0591 (8 pgs)	0
WP 0552 (6 pgs)	0	WP 0592 (12 pgs)	0
WP 0553 (2 pgs)	0	WP 0593 (2 pgs)	0
WP 0554 (2 pgs)	0	WP 0594 (2 pgs)	0
WP 0555 (10 pgs)	0	WP 0595 (2 pgs)	0
WP 0556 (2 pgs)	0	WP 0596 (4 pgs)	0
WP 0557 (4 pgs)	0	WP 0597 (2 pgs)	0
WP 0558 (20 pgs)	0	WP 0598 (2 pgs)	0
WP 0559 (4 pgs)	0	WP 0599 (4 pgs)	0
WP 0560 (4 pgs)	0	WP 0600 (4 pgs)	0
WP 0561 (2 pgs)	0	WP 0601 (6 pgs)	0
WP 0562 (8 pgs)	0	WP 0602 (4 pgs)	0
WP 0563 (4 pgs)	0	WP 0603 (4 pgs)	0
INDEX-1 thru INDEX-38	0	WP 0604 (6 pgs)	0
		WP 0605 (8 pgs)	0
		WP 0606 (18 pgs)	0
		WP 0607 (2 pgs)	0
		WP 0608 (2 pgs)	0
		WP 0609 (8 pgs)	0
		Chp 6 Title page	0
		WP 0610 (8 pgs)	0
		WP 0611 (4 pgs)	0
		WP 0612 (4 pgs)	0
		WP 0613 (4 pgs)	0
		WP 0614 (20 pgs)	0
		WP 0615 (478 pgs)	0
		WP 0616 (2 pgs)	0
		WP 0617 (4 pgs)	0
		WP 0618 (36 pgs)	0
		WP 0619 (50 pgs)	0
<b>VOLUME 4</b>			
Cover	0		
Warning Summary (4 pgs)	0		
i thru vi	0		
vii/(viii blank)	0		
Chp 5 Title Cont. page	0		
WP 0564 (10 pgs)	0		
WP 0565 (4 pgs)	0		
WP 0566 (4 pgs)	0		
WP 0567 (10 pgs)	0		
WP 0568 (4 pgs)	0		
WP 0569 (2 pgs)	0		
WP 0570 (10 pgs)	0		
WP 0571 (8 pgs)	0		

<b>Page/WP No.</b>	<b>Change No.</b>	<b>Page/WP No.</b>	<b>Change No.</b>
Chp 7 Title page . . . . .	0	WP 0623 (20 pgs) . . . . .	0
WP 0620 (2 pgs). . . . .	0	WP 0624 (4 pgs) . . . . .	0
WP 0621 (4 pgs). . . . .	0	WP 0625 (6 pgs) . . . . .	0
WP 0622 (22 pgs). . . . .	0	INDEX-1 thru INDEX-38 . . . . .	0

HEADQUARTERS  
DEPARTMENT OF THE ARMY  
WASHINGTON, D.C., 20 FEBRUARY 2009

**TECHNICAL MANUAL**

**OPERATOR'S AND FIELD LEVEL  
MAINTENANCE MANUAL  
WITH REPAIR PARTS AND SPECIAL TOOLS LIST  
(INCLUDING DEPOT REPAIR PARTS AND SPECIAL TOOLS)**

**FOR**

**TACTICAL FIRE FIGHTING TRUCK (TFFT)**

**MODEL M1142**

**NSN 4210-01-486-1035**

**REPORTING ERRORS AND RECOMMENDING IMPROVEMENTS**

You can help improve this publication. If you find any errors, or if you would like to recommend any improvements to the procedures in this publication, please let us know. The preferred method is to submit you DA Form 2028 (Recommended Changes to Publications and Blank Forms) through the Internet, on the Army Electronic Product Support (AEPS) website. The Internet address is <https://aeeps.ria.army.mil>. The DA Form 2028 is located under the Public Applications section in the AEPS Public Home Page. Fill out the form and click on SUBMIT. Using this form on the AEPS will enable us to respond quicker to your comments and better manage the DA Form 2028 program. You may also mail, e-mail, or fax your comments of DA Form 2028 directly to the U.S. Army TACOM Life Cycle Management Command. The postal mail address is U.S. Army TACOM Life Cycle Management Command, ATTN: AMSTA-LC-LMPP / TECH PUBS, 1 Rock Island Arsenal, Rock Island, IL 61299-7630. The e-mail address is [tacomlcmc.daform2028@us.army.mil](mailto:tacomlcmc.daform2028@us.army.mil). The fax number is DSN 793-0726 or Commercial (309) 782-0726.

\* **SUPERSEDURE NOTICE:** This manual supersedes TM 9-2320-279-10-3 dated 15 March 2004 and TM 9-2320-315-14&P dated 15 October 2004.

**DISTRIBUTION STATEMENT A:** Approved for public release; distribution is unlimited.

## TABLE OF CONTENTS

		<u>Page No.</u>	<u>WP Sequence No.</u>
<b>VOLUME 1</b>			
<b>CHAPTER 1</b>	<b>GENERAL INFORMATION AND DATA</b>		
	General Information . . . . .		WP 0001
	Figure 1. M1142 Tactical Fire Fighting Truck. . . . .	0001-1	
	Equipment Description and Data . . . . .		WP 0002
	Figure 1. Major Components of the M1142. . . . .	0002-6	
	Table 1. Legend for Figure 1. . . . .	0002-7	
	Table 2. Equipment Data. . . . .	0002-8	
	Theory of Operation . . . . .		WP 0003
<b>CHAPTER 2</b>	<b>OPERATOR INSTRUCTIONS</b>		
	<b>OPERATION UNDER USUAL CONDITIONS</b>		
	Description and Use of Operator's Controls and Indicators . . . . .		WP 0004
	Figure 1. Cab Instrument Panel - Upper Left. . . . .	0004-1	
	Figure 2. Cab Instrument Panel - Lower Left. . . . .	0004-2	
	Figure 3. Cab Instrument Panel - Upper Center. . . . .	0004-3	
	Figure 4. Cab Instrument Panel - Lower Center. . . . .	0004-4	
	Figure 5. Cab Instrument Panel - Lower Right. . . . .	0004-6	
	Figure 6. Cab Instrument Panel - Upper Right/ Electronic Siren Controls. . . . .	0004-7	
	Figure 7. Cab Instrument Panel - Upper Right/Radio. . . . .	0004-8	
	Figure 8. Cab Instrument Panel - Center Console. . . . .	0004-9	
	Figure 9. Bumper Turret Controls. . . . .	0004-12	
	Figure 10. Roof Turret Controls. . . . .	0004-14	
	Figure 11. Pump Operator's Panel - Upper Left. . . . .	0004-15	
	Figure 12. Pump Operator's Panel - Upper Center. . . . .	0004-16	
	Figure 13. Pump Operator's Panel - Upper Right. . . . .	0004-18	
	Figure 14. Pump Operator's Panel - Center Right. . . . .	0004-21	
	Figure 15. Pump Operator's Panel - Center. . . . .	0004-22	
	Figure 16. Pump Operator's Panel - Middle/Lower Left. . . . .	0004-23	
	Figure 17. Pump Operator's Panel - Lower Left. . . . .	0004-25	
	Figure 18. Pump Operator's Panel - Lower Right. . . . .	0004-26	



**TABLE OF CONTENTS (CONTINUED)**

	<u>Page No.</u>	<u>WP Sequence No.</u>
Figure 19. Passenger Side of Pump House. . . . .	0004-27	
Figure 20. Driver Side of Pump House. . . . .	0004-28	
Figure 21. Equipment (Ladder) Rack Control. . . . .	0004-29	
Figure 22. Rear Step Buzzer Control and Cord Reel Rewind. . . . .	0004-30	
Figure 23. Rear Compartment Test Switch Panel. . . . .	0004-31	
Figure 24. Crew Cab Heater/Air Conditioner. . . . .	0004-32	
Figure 25. Motorola Handheld Radio. . . . .	0004-32	
Figure 26. Hydraulic Generator Display. . . . .	0004-33	
Prepare to Operate Vehicle . . . . .		WP 0005
Preparation for Operation-Operational Modes. . . . .		WP 0006
Batteries Connect/Disconnect . . . . .		WP 0007
Crew Cab Air Conditioner Operation . . . . .		WP 0008
Crew Cab Air Conditioner/Heater Control Panel Set Point Programming . . . . .		WP 0009
Compartment Door(s) Open/Close . . . . .		WP 0010
Unstow/Stow Equipment (Ladder) Rack . . . . .		WP 0011
Unstow/Stow Crew Cab Access Steps . . . . .		WP 0012
Unstow/Stow Right Rear Access Ladder. . . . .		WP 0013
Unstow/Stow Rear Work Platform . . . . .		WP 0014
Hose Bed Covers Open/Close . . . . .		WP 0015
Unstow/Stow Pump Operator's Platform . . . . .		WP 0016
SINCGARS Radio Cover Open/Close . . . . .		WP 0017
Crew Cab Roof Hatch Open/Close . . . . .		WP 0018
Pump Operator's Panel Open/Close . . . . .		WP 0019
Water Tank Fill . . . . .		WP 0020
Starting/Stopping Hydraulic Generator . . . . .		WP 0021
Starting/Stopping Water Pump Engine (Cab Instrument Panel and Pump Operator's Panel) . . . . .		WP 0022
Priming Water Pump . . . . .		WP 0023
Pressure Governor Operation . . . . .		WP 0024
Pumping from Draft (Main Inlet). . . . .		WP 0025
Pumping from Onboard Water Tank . . . . .		WP 0026
Pumping from Hydrant or In Relay (Positive Water Sources) . . . . .		WP 0027

**TABLE OF CONTENTS (CONTINUED)**

	<u>Page No.</u>	<u>WP Sequence No.</u>
Pump and Roll Procedures. . . . .		WP 0028
Draining Water Tank. . . . .		WP 0029
Foam System General Information. . . . .		WP 0030
Foam Agent Filling/Draining/Flushing. . . . .		WP 0031
Foam System and Instrument Panel-Standby Mode . . . . .		WP 0032
Foam System Operating Procedures (Pump Operator's Panel). . . . .		WP 0033
Foam System Operating Procedures (Cab Instrument Panel). . . . .		WP 0034
Bumper Turret Operation . . . . .		WP 0035
Roof Turret Operation. . . . .		WP 0036
Cord Reel Operation. . . . .		WP 0037
Windshield Deluge Operation. . . . .		WP 0038
Ground Sweeps Operation . . . . .		WP 0039
Foam System Flushing. . . . .		WP 0040
Post Operation Procedures . . . . .		WP 0041
Water Pump and Water Tank Flush . . . . .		WP 0042
Preparation for Storage or Shipment . . . . .		WP 0043
Pump and Plumbing Blow-Out Procedures . . . . .		WP 0044
<b>OPERATION UNDER UNUSUAL CONDITIONS</b>		
Operation in Cold Environment, -25 to 32°F (-32 to 0°C). . . . .		WP 0045
Stowage and Data Plate Guide . . . . .		WP 0046
On-Truck Load Plan . . . . .		WP 0047
Figure 1. Location of Stowage Compartments. . . . .	0047-1	
Table 1. Load Plan (Stowage Compartment D1). . . . .	0047-2	
Table 2. Load Plan (Stowage Compartment D2). . . . .	0047-3	
Table 3. Load Plan (Stowage Compartment D3). . . . .	0047-4	
Table 4. Load Plan (Stowage Compartment D4). . . . .	0047-5	
Table 5. Load Plan (Stowage Compartment D5). . . . .	0047-6	
Table 6. Load Plan (Stowage Compartment R1). . . . .	0047-7	
Table 7. Load Plan (Stowage Compartment R2). . . . .	0047-8	
Table 8. Load Plan (Stowage Compartment P1). . . . .	0047-9	
Table 9. Load Plan (Stowage Compartment P2). . . . .	0047-10	
Table 10. Load Plan (Stowage Compartment P3). . . . .	0047-11	

**TABLE OF CONTENTS (CONTINUED)**

	<u>Page No.</u>	<u>WP Sequence No.</u>
Table 11. Load Plan (Stowage Compartment P4). . . . .	0047-12	
Table 12. Load Plan (Stowage Compartment P5). . . . .	0047-13	
Table 13. Load Plan (Stowage Compartment T1). . . . .	0047-14	
Table 14. Load Plan (Stowage Compartment T2). . . . .	0047-15	
<b>CHAPTER 3 TROUBLESHOOTING PROCEDURES</b>		
Troubleshooting Instructions Introduction . . . . .		WP 0048
Operator Level Troubleshooting Fault Index . . . . .		WP 0049
Table 1. Operator Level Troubleshooting Fault Index. . . . .	0049-1	
Field Level Maintenance Troubleshooting Fault Index . . . . .		WP 0050
Table 1. Field Level Maintenance Troubleshooting Fault Index. . . . .	0050-1	
<b>OPERATOR LEVEL TROUBLESHOOTING</b>		
120 VAC Outlet(s) Does Not Operate . . . . .		WP 0051
24-Volt Battery Charger Does Not Operate. . . . .		WP 0052
Check Pump Engine Light Comes On. . . . .		WP 0053
Crew Cab Air Conditioning Does Not Operate Properly . . . . .		WP 0054
Crew Cab Heater Does Not Operate Properly. . . . .		WP 0055
Deck Lights, Crew Cab Dome Lights, Clearance Lights, and Compartment Lights Do Not Operate . . . . .		WP 0056
DO NOT MOVE APPARATUS WHEN LIGHT IS ON Indicator Flashes . . . . .		WP 0057
Extendable Floodlights Do Not Operate . . . . .		WP 0058
Streamlight Battery Charger(s) Does Not Charge Batteries . . . . .		WP 0059
Foam System Does Not Operate . . . . .		WP 0060
Pump Engine Cranks But Fails to Start . . . . .		WP 0061
Pump Engine Governor Control Does Not Operate. . . . .		WP 0062
Pump Engine Runs Rough or Shuts Down While Running . . . . .		WP 0063
Pump Does Not Prime . . . . .		WP 0064
Pump Loses Prime . . . . .		WP 0065
Drain Valves Leaking During Pumping Operations . . . . .		WP 0066
Handheld Radio Battery Charger(s) Does Not Charge Batteries . . . . .		WP 0067
Warning Lights Do Not Operate . . . . .		WP 0068
Discharges Have Abnormal Water Streams . . . . .		WP 0069

**TABLE OF CONTENTS (CONTINUED)**

	<u>Page No.</u>	<u>WP Sequence No.</u>
<b>FIELD LEVEL TROUBLESHOOTING</b>		
<b>REFRIGERATION AND AIR CONDITIONING COMPONENTS</b>		
Crew Cab Air Conditioner/Heater Does Not Operate Properly . . . . .		WP 0070
Crew Cab Air Conditioner Compressor Excessively Noisy . . . . .		WP 0071
Crew Cab Air Conditioner Does Not Cool or Cools Inadequately . . . . .		WP 0072
<b>FIRE PUMP SYSTEM</b>		
Water Pump Engine Cranks But Will Not Start or Hard to Start From Personnel Cab and Pump Operator's Panel . . . . .		WP 0073
Water Pump Engine Fails To Crank From Personnel Cab and Pump Operator's Panel . . . . .		WP 0074
Water Pump Engine Fails To Crank From Personnel Cab . . . . .		WP 0075
Water Pump Engine Fails To Crank From Pump Operator's Panel . . . . .		WP 0076
Water Pump Engine Pressure Governor Control Panel Does Not Change Engine Speed . . . . .		WP 0077
Water Pump Engine Pressure Governor Control Panel Does Not Change Pump Pressure . . . . .		WP 0078
Water Pump Engine Pressure Governor Control Panel Message Center Displays Sensor or Cavitate . . . . .		WP 0079
Water Pump Engine Pressure Governor Control Panel Changes Engine Speed, But Oscillates While In RPM Mode . . . . .		WP 0080
Water Pump Engine Pressure Governor Control Panel Changes Engine Speed, But Oscillates While In PSI Mode . . . . .		WP 0081
Water Pump Engine Pressure Governor Controls Do Not Maintain System Pressure When Discharge Valve is Being Opened or Closed . . . . .		WP 0082
Water Pump Engine Pressure Governor Control Panel PSI PRESET Control Does Not Operate . . . . .		WP 0083
Water Pump Engine Hourmeter Does Not Operate . . . . .		WP 0084
Water Pump Engine is Hard To Start When Cold, Below 32°F (0°C) . . . . .		WP 0085
Water Pump Engine is Producing Blue Exhaust Smoke, Water Temp Reads Over 180°F (82°C) . . . . .		WP 0086
Water Pump Engine is Producing Excessive Black or Gray Exhaust Smoke, Water Temp Reads Over 180°F (82°C) . . . . .		WP 0087
Water Pump Engine is Producing White Exhaust Smoke, Water Temp Reads Over 180°F (82°C) . . . . .		WP 0088
Water Pump Engine Misfires, Runs Rough, or Lacks Power . . . . .		WP 0089
Water Pump Noisy . . . . .		WP 0090

**TABLE OF CONTENTS (CONTINUED)**

	<u>Page No.</u>	<u>WP Sequence No.</u>
Water Pump Engine Oil Consumption is High or Leaks Oil . . . . .		WP 0091
Water Pump Engine Oil Pressure is Low. . . . .		WP 0092
Water Pump Engine Overheats. . . . .		WP 0093
<b>FOAM PROPORTIONER SYSTEM</b>		
Foam Not Delivered From All Systems (Bumper Turret, Ground Sweeps, and Manual Metering Controls) or System Does Not Shut Off . . . . .		WP 0094
Foam Not Delivered When Tank A is Selected (Bumper Turret, Ground Sweeps, and Manual Metering Controls) . . . . .		WP 0095
Foam Not Delivered When Tank B is Selected (Bumper Turret, Under Truck Nozzles, and Manual Metering Controls) . . . . .		WP 0096
Foam Not Delivered From Bumper Turret . . . . .		WP 0097
Foam Not Delivered From Roof Turret . . . . .		WP 0098
Foam Not Delivered From Ground Sweeps. . . . .		WP 0099
Foam Not Delivered When Manual Metering Control is Operated . . . . .		WP 0100
Foam System Cannot Be Flushed. . . . .		WP 0101
Foam A Tank Level Indicator Gauge Does Not Operate Properly. . . . .		WP 0102
Foam B Tank Level Indicator Gauge Does Not Operate Properly. . . . .		WP 0103
<b>WATER TANK ASSEMBLY</b>		
Bumper Turret Does Not Operate Properly When Selected . . . . .		WP 0104
Direct Tank Fill Valve Does Not Operate Properly (Auto or Manual Mode) . . . . .		WP 0105
Driver Main Inlet Valve Does Not Operate Properly . . . . .		WP 0106
Driver Side Pre-Connect A Valve Does Not Operate Properly . . . . .		WP 0107
Driver Side Pre-Connect B Valve Does Not Operate Properly . . . . .		WP 0108
No. 1 Discharge Valve (Driver Side) Does Not Operate Properly . . . . .		WP 0109
No. 2 Discharge Valve (Driver Side) Does Not Operate Properly . . . . .		WP 0110
No. 3 Discharge Valve (Passenger Side) Does Not Operate Properly . . . . .		WP 0111
No. 4 Discharge Valve (Passenger Side) Does Not Operate Properly . . . . .		WP 0112
Passenger Side Auxiliary Inlet Valve Does Not Operate Properly. . . . .		WP 0113
Pump Cooler Valve Does Not Operate Properly . . . . .		WP 0114
Pump Priming System Does Not Operate Properly. . . . .		WP 0115
Roof Turret Does Not Operate When Selected . . . . .		WP 0116
System Will Not Build or Hold Air Pressure During Blow-Out Procedure . . . . .		WP 0117
Tank Fill & Re-Circulating Valve Does Not Operate Properly . . . . .		WP 0118

**TABLE OF CONTENTS (CONTINUED)**

	<u>Page No.</u>	<u>WP Sequence No.</u>
Tank-To-Pump Valve(s) Does Not Operate Properly . . . . .		WP 0119
Ground Sweeps Do Not Operate When Selected . . . . .		WP 0120
Hydraulic Generator PTO Does Not Engage When Selected . . . . .		WP 0121
Water Tank Drain Valve Does Not Operate When Selected . . . . .		WP 0122
Water Tank Level Indicator Gauge Does Not Operate Properly . . . . .		WP 0123
Water Pump Output Pressure is Low . . . . .		WP 0124
Windshield Deluge System Does Not Operate Properly . . . . .		WP 0125

**VOLUME 2**

**CHAPTER 3 TROUBLESHOOTING PROCEDURES (CONTINUED)**

**INSTRUMENT HOUSING ASSEMBLY**

Cab Switch Backlighting Does Not Operate . . . . .		WP 0126
Digital Pressure Gauge(s) Does Not Operate . . . . .		WP 0127
Direct Tank Fill AUTO Indicator Does Not Illuminate (Pump Operator's Panel). . . . .		WP 0128
Direct Tank Fill OPEN Indicator Does Not Illuminate (Pump Operator's Panel). . . . .		WP 0129
DO NOT MOVE APPARATUS WHEN LIGHT IS ON Indicator Does Not Operate Properly . . . . .		WP 0130
Equipment (Ladder) Rack Does Not Operate. . . . .		WP 0131
FOAM FLUSH Indicator Does Not Illuminate (Pump Operator's Panel). . . . .		WP 0132
FOAM SYSTEM Indicator Does Not Illuminate (Cab) . . . . .		WP 0133
FOAM SYSTEM Indicator Does Not Illuminate (Pump Operator's Panel) . . . . .		WP 0134
Pump Cooler Open Indicator Does Not Illuminate (Cab) . . . . .		WP 0135
PUMP COOLER Indicator Does Not Illuminate (Pump Operator's Panel) . . . . .		WP 0136
PUMP ENGINE RUNNING Indicator Not Illuminated When Water Pump Engine is Running . . . . .		WP 0137
PUMP HOT Alarm/Indicator Does Not Operate When Tested or Pump Overheat Condition (Pump Operator's Panel) . . . . .		WP 0138
GEN PTO ENGAGE Indicator Does Not Illuminate (Cab) . . . . .		WP 0139
Roof Turret Indicator Does Not Operate. . . . .		WP 0140
TANK DRAIN Indicator Does Not Illuminate (Pump Operator's Panel) . . . . .		WP 0141
TANK TO PUMP Indicator Does Not Illuminate (Cab) . . . . .		WP 0142

**TABLE OF CONTENTS (CONTINUED)**

	<u>Page No.</u>	<u>WP Sequence No.</u>
TANK TO PUMP Indicator Does Not Illuminate (Pump Operator's Panel) . . . . .		WP 0143
GROUND SWEEPS Indicator Does Not Illuminate (Cab) . . . . .		WP 0144
Water Pump Engine Pressure Governor Control Panel is Not Disabled, When Other Governor Control Panel is Activated . . . . .		WP 0145
Water Pump Engine Pressure Governor Control Panel Does Not Operate Properly . . . . .		WP 0146
Water Pump Engine Pressure Governor Control Panel Throttle Ready and/or Pump Engage LEDs Do Not Illuminate . . . . .		WP 0147
Water Pump Engine Pressure Governor Control Panel Message Display is Garbled or Dim . . . . .		WP 0148
Water Pump Engine Gauge Panel Does Not Operate Properly . . . . .		WP 0149
<b>SIREN ASSEMBLY</b>		
Siren Does Not Operate Properly . . . . .		WP 0150
<b>WARNING LIGHT ASSEMBLY</b>		
Warning Lights (All) Do Not Operate . . . . .		WP 0151
Warning Lights (Front and Rear) Do Not Operate . . . . .		WP 0152
Warning Lights (Overhead Beacon) Do Not Operate . . . . .		WP 0153
Warning Lights (Cab Roof Lightbar) Do Not Operate . . . . .		WP 0154
Warning Lights (Side) Do Not Operate . . . . .		WP 0155
Warning Lights (Upper Rear) Do Not Operate . . . . .		WP 0156
<b>SPOTLIGHTS</b>		
Deck Lights Do Not Operate . . . . .		WP 0157
Extendable Floodlights Do Not Operate . . . . .		WP 0158
<b>DOME AND ENGINE LIGHT ASSEMBLY</b>		
Crew Cab Dome Light Does Not Operate . . . . .		WP 0159
<b>MISCELLANEOUS ELECTRICAL COMPONENTS</b>		
12-Volt Handheld Radio Battery Charger(s) Does Not Operate (Personnel Cab) . . . . .		WP 0160
12-Volt Handheld Radio Battery Charger(s) Does Not Operate (Crew Cab) . . . . .		WP 0161
12-Volt Flashlight Charger(s) Does Not Operate . . . . .		WP 0162
120-Volt Air Compressor Does Not Operate Properly . . . . .		WP 0163
120-Volt Receptacles Do Not Operate . . . . .		WP 0164
Table 1. Receptacle to Circuit Breaker List . . . . .	0164-3	
120-Volt Cord Reel Receptacles Do Not Operate . . . . .		WP 0165
24-Volt Battery Charger Does Not Operate . . . . .		WP 0166

**TABLE OF CONTENTS (CONTINUED)**

	<u>Page No.</u>	<u>WP Sequence No.</u>
Battery Equalizer Does Not Operate Properly . . . . .		WP 0167
Clearance and/or Directional Light(s) Does Not Operate . . . . .		WP 0168
Cord Reel Rewind Control Does Not Operate . . . . .		WP 0169
Two-Way Radio Does Not Operate Properly . . . . .		WP 0170
Hydraulic Generator Does Not Operate Properly . . . . .		WP 0171
Hydraulic Generator Oil Cooling Fan Does Not Operate Properly . . . . .		WP 0172
Intercom and Headsets Do Not Operate Properly . . . . .		WP 0173
Passenger Side and Rear Stowage Compartment Light(s) Do Not Operate . . . . .		WP 0174
Pump House Fan Does Not Operate Properly . . . . .		WP 0175
Pump House or Pump Operator's Panel Work Light(s) Does Not Operate . . . . .		WP 0176
Driver Side Stowage Compartment Light(s) Does Not Operate . . . . .		WP 0177
Rear Step Buzzer Does Not Operate Properly . . . . .		WP 0178
SINCGARS Do Not Operate Properly . . . . .		WP 0179
Shoreline Inlet Receptacle Does Not Operate Properly . . . . .		WP 0180
<b>HEATER, VEHICULAR COMPARTMENT</b>		
Piping Heat Trace Does Not Operate Properly . . . . .		WP 0181
Pump House Heater Does Not Operate Properly . . . . .		WP 0182
Rear Compartment Heater Does Not Operate Properly . . . . .		WP 0183
Water Tank Heater Does Not Operate Properly . . . . .		WP 0184
<b>CHAPTER 4 PREVENTIVE MAINTENANCE CHECKS AND SERVICES (PMCS)</b>		
Preventive Maintenance Checks and Services (PMCS) Introduction . . . . .		WP 0185
Preventive Maintenance Checks and Services (PMCS), Including Lubrication Instructions . . . . .		WP 0186
Table 1. Preventive Maintenance Checks and Services. . . . .	0186-2	
Table 2. Lubricating Chart. . . . .	0186-38	
<b>CHAPTER 5 FIELD LEVEL MAINTENANCE</b>		
Maintenance General Introduction . . . . .		WP 0187
Table 1. Recommended Flats Rotation. . . . .	0187-9	
Figure 1. General Tightening Sequences. . . . .	0187-10	
<b>ADJUSTMENTS AND ALIGNMENTS</b>		
Bumper Turret and Bumper Turret Nozzle Speed Adjustment. . . . .		WP 0188
Crew Cab Air Conditioner Compressor Drive Belt Adjustment. . . . .		WP 0189
Crew Cab Door/Door Hinge Adjustment. . . . .		WP 0190



**TABLE OF CONTENTS (CONTINUED)**

	<u>Page No.</u>	<u>WP Sequence No.</u>
Foam Level Probe Calibration . . . . .		WP 0191
Hydraulic Generator Compensator Adjustment . . . . .		WP 0192
Pressure Governor Adjustment . . . . .		WP 0193
Table 1. Personnel Cab Governor Control . . . . .	0193-1	
Table 2. Pump Operator's Panel Governor Control . . . . .	0193-1	
Table 3. Personnel Cab Governor Control . . . . .	0193-4	
Table 4. Pump Operator's Panel Governor Control . . . . .	0193-4	
Water Pump Engine Compression Test . . . . .		WP 0194
Water Pump Engine Coolant/Fuel Pump Belts Adjustment . . . . .		WP 0195
Water Pump Engine Valve Lash Adjustment and Injection Nozzle Pressure Check . . . . .		WP 0196
<b>REFRIGERATION AND AIR CONDITIONING COMPONENTS</b>		
Crew Cab Air Conditioner Binary Switch Replacement . . . . .		WP 0197
Crew Cab Air Conditioner Compressor Drive Belt Replacement . . . . .		WP 0198
Crew Cab Air Conditioner Condenser Fan Assemblies Replacement . . . . .		WP 0199
Crew Cab Air Conditioner/Heater Blower Motor Replacement . . . . .		WP 0200
Crew Cab Air Conditioner/Heater Control Box Replacement . . . . .		WP 0201
Crew Cab Air Conditioner/Heater Control Panel Replacement . . . . .		WP 0202
Crew Cab Air Conditioner/Heater Fresh Air Fan and Filter Replacement . . . . .		WP 0203
Crew Cab Air Conditioner/Heater Fresh Air Resistor Replacement . . . . .		WP 0204
Crew Cab Air Conditioner/Heater Louvers Replacement . . . . .		WP 0205
Crew Cab Air Conditioner Thermostatic Switch Replacement . . . . .		WP 0206
Crew Cab Heater Control Valve Replacement . . . . .		WP 0207
Crew Cab Heater Core Replacement . . . . .		WP 0208
Crew Cab Heater Hoses Replacement . . . . .		WP 0209
Crew Cab Air Conditioner Compressor and Motor Assembly Replacement . . . . .		WP 0210
Crew Cab Air Conditioner Condenser Replacement . . . . .		WP 0211
Crew Cab Air Conditioner Dryer Replacement . . . . .		WP 0212
Crew Cab Air Conditioner Expansion Valve Replacement . . . . .		WP 0213
Crew Cab Air Conditioner Evaporator Core Replacement . . . . .		WP 0214
Crew Cab Air Conditioner/Heater Assembly Replacement . . . . .		WP 0215
Crew Cab Air Conditioner Hoses Replacement . . . . .		WP 0216

**TABLE OF CONTENTS (CONTINUED)**

	<u>Page No.</u>	<u>WP Sequence No.</u>
Crew Cab Air Conditioner Service/Recharge . . . . .		WP 0217
Table 1. Pressure Temperature Chart. . . . .	0217-12	
<b>BRAKE SYSTEM MAINTENANCE</b>		
Air Reservoir Replacement. . . . .		WP 0218
<b>FIRE PUMP ASSEMBLY</b>		
Water Pump Engine Replacement . . . . .		WP 0219
Water Pump Engine Air Cleaner Assembly Replacement . . . . .		WP 0220
Water Pump Engine Air Filter Ductwork Replacement. . . . .		WP 0221
Water Pump Engine Air Intake Pre-Filter Replacement . . . . .		WP 0222
Water Pump Engine Alternator Replacement. . . . .		WP 0223
Water Pump Engine Alternator Belt Replacement/Adjustment . . . . .		WP 0224
Water Pump Engine Battery Cables Replacement. . . . .		WP 0225
Water Pump Engine Electronic Control Unit (ECU) Replacement . . . . .		WP 0226
Water Pump Engine Exhaust Manifold Replacement. . . . .		WP 0227
Water Pump Engine Exhaust Pipes Replacement . . . . .		WP 0228
Water Pump Engine Expansion Plug Replacement . . . . .		WP 0229
Water Pump Engine Fan Belts Replacement/Adjustment . . . . .		WP 0230
Water Pump Engine Fuel Filter Replacement . . . . .		WP 0231
Water Pump Engine Fuel Filter Head Replacement. . . . .		WP 0232
Water Pump Engine Fuel Injector(s) Replacement . . . . .		WP 0233
Water Pump Engine Fuel Lines Replacement . . . . .		WP 0234
Water Pump Engine Fuel Line Check Valve(s) Replacement . . . . .		WP 0235
Water Pump Engine Fuel Pump Replacement. . . . .		WP 0236
Water Pump Engine Fuel System Bleed . . . . .		WP 0237
Water Pump Engine Fuel/Water Separator Replacement . . . . .		WP 0238
Water Pump Engine Glow Plug Replacement . . . . .		WP 0239
Water Pump Engine Heat Exchanger Replacement . . . . .		WP 0240
Water Pump Engine Muffler Replacement . . . . .		WP 0241
Water Pump Engine Noise Panels Replacement . . . . .		WP 0242
Water Pump Engine Oil Drain/Fill. . . . .		WP 0243
Water Pump Engine Oil Filter Replacement. . . . .		WP 0244
Water Pump Engine Oil Pressure Sending Unit Replacement. . . . .		WP 0245

**TABLE OF CONTENTS (CONTINUED)**

	<u>Page No.</u>	<u>WP Sequence No.</u>
Water Pump Engine Oil Pressure Switch Replacement . . . . .		WP 0246
Water Pump Engine Remote Oil Filter Head and Hose Replacement . . . . .		WP 0247
Water Pump Engine Starter Motor Replacement . . . . .		WP 0248
Water Pump Engine Thermostat Replacement . . . . .		WP 0249
Water Pump Engine Turbocharger Replacement . . . . .		WP 0250
Water Pump Engine Valve Cover and Gasket Replacement . . . . .		WP 0251
Water Pump Gear Case Oil Change . . . . .		WP 0252
Water Pump Gear Case Oil Check . . . . .		WP 0253
Water Pump Gear Case Oil Fill Hose Replacement . . . . .		WP 0254
Water Pump Replacement . . . . .		WP 0255
<b>RELIEF VALVE ASSEMBLY</b>		
Auxiliary Intake Relief/Dump Valve (Passenger Side) Replacement . . . . .		WP 0256
High Pressure Water Source Intake Relief Valve Setting . . . . .		WP 0257
Main Intake Relief/Dump Valve (Driver Side) Replacement . . . . .		WP 0258
Thermal Relief Valve Replacement . . . . .		WP 0259
<b>PRIMER PUMP ASSEMBLY</b>		
Primer Pump Motor Control Solenoid Replacement . . . . .		WP 0260
Primer Pump Valve Motor Inline Fuse Replacement . . . . .		WP 0261
Primer Pump Replacement . . . . .		WP 0262
Primer Pump Repair . . . . .		WP 0263
Primer Tank Replacement . . . . .		WP 0264
Primer Valve Cable Replacement . . . . .		WP 0265
Primer Valve Control Solenoid(s) Replacement . . . . .		WP 0266
Pump Primer Valve Replacement . . . . .		WP 0267
Driver Main Inlet Primer Valve Replacement . . . . .		WP 0268
<b>DRAIN VALVE ASSEMBLY</b>		
Bumper Turret Auto Drain Valve Replacement . . . . .		WP 0269
Drain Valve, Driver Pre-Connect A Replacement . . . . .		WP 0270
Drain Valve, Driver Pre-Connect B Replacement . . . . .		WP 0271
Drain Valve (Multi-Port) Replacement . . . . .		WP 0272
Foam System "A & B" Tank Drain Replacement . . . . .		WP 0273
No. 1 Discharge Drain Valve (Driver Side) Replacement . . . . .		WP 0274

**TABLE OF CONTENTS (CONTINUED)**

	<u>Page No.</u>	<u>WP Sequence No.</u>
No. 2 Discharge Drain Valve (Driver Side) Replacement . . . . .		WP 0275
No. 3 Discharge Drain Valve (Passenger Side) Replacement . . . . .		WP 0276
No. 4 Discharge Drain Valve (Passenger Side) Replacement . . . . .		WP 0277
Passenger Side Auxiliary Inlet and Driver Side Main Inlet Bleeder Valve Replacement . . . . .		WP 0278
Water Tank Drain Valve Replacement . . . . .		WP 0279
<b>FOAM SYSTEM ASSEMBLY</b>		
Flush Check Valve Replacement . . . . .		WP 0280
Foam Level Probe Replacement . . . . .		WP 0281
Foam System "A" Check Valve Replacement . . . . .		WP 0282
Foam System "B" Check Valve Replacement . . . . .		WP 0283
Foam System "A" Shutoff Valve Replacement . . . . .		WP 0284
Foam System "B" Shutoff Valve Replacement . . . . .		WP 0285
Foam System Eductor Replacement . . . . .		WP 0286
Foam System Eductor Valve Replacement . . . . .		WP 0287
Foam System Flow Control Manifold Replacement . . . . .		WP 0288
Foam System Flush Valve Replacement . . . . .		WP 0289
Foam System Inlet Check Valve Replacement . . . . .		WP 0290
Foam System Manual Metering Valve Replacement . . . . .		WP 0291
Foam System Multi-Metering Valve (Automatic) Replacement . . . . .		WP 0292
Foam Tank Fill Port Extensions and Covers Replacement . . . . .		WP 0293

**VOLUME 3**

**CHAPTER 5 FIELD LEVEL MAINTENANCE (CONTINUED)**

**WATER TANK ASSEMBLY**

Auxiliary Inlet Valve (Passenger Side) Replacement . . . . .	WP 0294
Tank-to-Pump Check Valve (Driver Side) Replacement . . . . .	WP 0295
Tank-to-Pump Check Valve (Passenger Side) Replacement . . . . .	WP 0296
Water Level Probe Replacement . . . . .	WP 0297
Water Tank Replacement . . . . .	WP 0298
Water Tank Fill Valve Replacement . . . . .	WP 0299
Water Tank Heater Replacement . . . . .	WP 0300

**TABLE OF CONTENTS (CONTINUED)**

	<u>Page No.</u>	<u>WP Sequence No.</u>
Water Tank Heater Control Box Replacement . . . . .		WP 0301
Water Tank Low Level Switch Replacement . . . . .		WP 0302
Water Tank Side Fill Valve Replacement . . . . .		WP 0303
Water Tank Vent/Fill Replacement . . . . .		WP 0304
<b>INSTRUMENT HOUSING ASSEMBLY</b>		
Personnel Cab Do Not Move Apparatus Indicator Replacement. . . . .		WP 0305
Personnel Cab Foam Tank Selector Indicator Replacement. . . . .		WP 0306
Personnel Cab Foam Tank Selector Indicator Lamp Replacement. . . . .		WP 0307
Personnel Cab Foam Tank Selector Switch Replacement . . . . .		WP 0308
Personnel Cab Pressure Governor Control Panel Replacement. . . . .		WP 0309
Personnel Cab High Idle Switch and Indicator Replacement . . . . .		WP 0310
Personnel Cab Instrument Panel Replacement. . . . .		WP 0311
Personnel Cab Instrument Panel Assembly Replacement . . . . .		WP 0312
Personnel Cab Panel Indicator Replacement . . . . .		WP 0313
Personnel Cab Panel Indicator Lamp(s) Replacement . . . . .		WP 0314
Personnel Cab Toggle Switch Replacement . . . . .		WP 0315
Personnel Cab Water and/or Foam Level Gauge(s) Replacement. . . . .		WP 0316
Pump Digital Pressure Gauge(s) (Discharge and Intake) Replacement . . . . .		WP 0317
Pump Operator's Panel Air Flow Restrictor Indicator Replacement . . . . .		WP 0318
Audio Alarm Replacement. . . . .		WP 0319
Pump Operator's Panel Cover Replacement. . . . .		WP 0320
Pump Operator's Panel Engine Diagnostics Plug Replacement. . . . .		WP 0321
Pump Operator's Panel Foam Level Gauge Replacement . . . . .		WP 0322
Pump Operator's Panel Fuel Gauge Replacement . . . . .		WP 0323
Pump Operator's Panel Hourmeter Replacement. . . . .		WP 0324
Pump Operator's Panel Housing Open/Close . . . . .		WP 0325
Pump Operator's Panel Indicator Light Replacement . . . . .		WP 0326
Pump Operator's Panel Indicator Lamp Replacement . . . . .		WP 0327
Pump Operator's Panel Light Switch Replacement. . . . .		WP 0328
Pump Operator's Panel Manual Primer Handle Replacement . . . . .		WP 0329
Pump Operator's Panel Momentary Toggle Switch Replacement. . . . .		WP 0330
Pump Operator's Panel Overheat Test Button . . . . .		WP 0331

**TABLE OF CONTENTS (CONTINUED)**

	<u>Page No.</u>	<u>WP Sequence No.</u>
Pump Operator’s Panel Pressure Governor Control Panel Replacement . . . . .		WP 0332
Pump Operator’s Panel Primer Switch Replacement . . . . .		WP 0333
Pump Operator’s Panel Replacement . . . . .		WP 0334
Pump Operator’s Panel Side Lamp and Bracket Replacement . . . . .		WP 0335
Pump Operator’s Panel Test Gauge Panel Replacement . . . . .		WP 0336
Pump Operator’s Panel Three-Position Toggle Switch Replacement . . . . .		WP 0337
Pump Operator’s Panel Two-Position Toggle Switch Replacement. . . . .		WP 0338
Pump Operator’s Panel Water Level Gauge Replacement . . . . .		WP 0339
Water Pump Engine Gauge Panel Replacement . . . . .		WP 0340
<b>SIREN ASSEMBLY</b>		
Siren Control Replacement . . . . .		WP 0341
<b>WARNING LIGHT ASSEMBLY</b>		
Lower Rear Marker Light and Bracket Replacement . . . . .		WP 0342
Marker Light (Amber LED) Replacement . . . . .		WP 0343
Personnel Cab Clearance Light and Bracket Replacement . . . . .		WP 0344
Personnel Cab Front Lightbar Replacement . . . . .		WP 0345
Personnel Cab Side Lightbar Replacement . . . . .		WP 0346
Personnel Cab Lightbar Repair . . . . .		WP 0347
Personnel Cab Warning Light and Do Not Move Apparatus Flasher Units Replacement . . . . .		WP 0348
Rear Marker/Clearance LED Replacement . . . . .		WP 0349
Roof Mounted Clearance Lights Replacement. . . . .		WP 0350
Warning Lights Replacement . . . . .		WP 0351
<b>SPOTLIGHTS</b>		
Deck Spotlight Replacement . . . . .		WP 0352
Deck Spotlight Lamp Replacement . . . . .		WP 0353
Extendable Floodlight Replacement. . . . .		WP 0354
Extendable Floodlight Lamp Replacement. . . . .		WP 0355
Overhead Beacon Light Replacement . . . . .		WP 0356
<b>DOME AND ENGINE LIGHT ASSEMBLY</b>		
Dome Light (LED & Incandescent) Replacement. . . . .		WP 0357

**TABLE OF CONTENTS (CONTINUED)**

	<u>Page No.</u>	<u>WP Sequence No.</u>
<b>MISCELLANEOUS ELECTRICAL COMPONENTS</b>		
120-Volt Air Compressor Replacement . . . . .		WP 0358
24-Volt Battery Charger Replacement . . . . .		WP 0359
120-Volt Circuit Breaker Replacement . . . . .		WP 0360
120-Volt Power Cord(s) Replacement . . . . .		WP 0361
Table 1. 120-Volt Power Cords. . . . .	0361-2	
120-Volt Receptacle Replacement . . . . .		WP 0362
Auto Fill Control Replacement . . . . .		WP 0363
Battery Box and Bracket Replacement . . . . .		WP 0364
Battery Charger(s) Receptacle Replacement . . . . .		WP 0365
Battery Disconnect Switch and Box Replacement. . . . .		WP 0366
Battery Equalizer Replacement . . . . .		WP 0367
Batteries, Terminal, and Cable Replacement . . . . .		WP 0368
Blackout Relay Replacement . . . . .		WP 0369
Bumper Turret and Pump Cooler Dump-To-Ground Control Valve Replacement . . . . .		WP 0370
Cab Roof Lightbar Cable Assembly Replacement . . . . .		WP 0371
Cab Roof Lightbar Cable Assembly Branch Replacement . . . . .		WP 0372
Circuit Breaker Box Replacement . . . . .		WP 0373
Compartment Light Replacement . . . . .		WP 0374
Control Valve Replacement . . . . .		WP 0375
Cord Reel Repair . . . . .		WP 0376
Cord Reel Cable, Work Light, and Receptacle Box Replacement. . . . .		WP 0377
Cord Reel Cable Work Light Lamp Replacement . . . . .		WP 0378
Cord Reel Cable Work Light Bracket Replacement. . . . .		WP 0379
Cord Reel Control Assembly Replacement . . . . .		WP 0380
Cord Reel Replacement . . . . .		WP 0381
Cord Reel Rewind Circuit Breaker Replacement. . . . .		WP 0382
Cord Reel Rewind Solenoid Replacement . . . . .		WP 0383
Cover, Door, and Electronic Mounting Base (SINCGARS) Replacement . . . . .		WP 0384
Door Switch Replacement . . . . .		WP 0385
Dual Governor Pressure Switch Replacement . . . . .		WP 0386

**TABLE OF CONTENTS (CONTINUED)**

	<u>Page No.</u>	<u>WP Sequence No.</u>
Electronically-Operated Ball Valve Seats and Preformed Packing Replacement .....		WP 0387
Electronically-Operated Ball Valve Electric Motor and Drive Assembly Replacement .....		WP 0388
Equipment (Ladder) Rack Control Assembly Replacement .....		WP 0389
Flow Sensor Replacement .....		WP 0390
Glow Plug Circuit Breaker Replacement .....		WP 0391
Glow Plug Control Relay Replacement .....		WP 0392
High Amperage Cable Replacement .....		WP 0393
Table 1. Positive High Amperage Cable Routing. ....	0393-2	
Figure 1. Positive High Amperage Cable Routing. ....	0393-3	
Table 2. Negative High Amperage Cable Routing. ....	0393-4	
Figure 2. Negative High Amperage Cable Routing. ....	0393-5	
Inline Fuse Replacement .....		WP 0394
Intercom Replacement .....		WP 0395
Light Bezel Replacement .....		WP 0396
Light Bezel Cover Replacement .....		WP 0397
Personnel Cab Power Distribution Box Circuit Breaker Replacement .....		WP 0398
Personnel Cab Power Distribution Box Diode Block Replacement .....		WP 0399
Personnel Cab Power Distribution Block Replacement. ....		WP 0400
Personnel Cab Power Distribution Box Fuse Replacement .....		WP 0401
Personnel Cab Power Distribution Box Relays Replacement .....		WP 0402
Personnel Cab Roof Lightbar Flasher Unit Replacement. ....		WP 0403
Personnel Cab Step Clearance Light Replacement .....		WP 0404
Portable Handheld Flashlight and Charger Replacement .....		WP 0405
Portable Handheld Radio and Charger Replacement .....		WP 0406
Power Distribution Box (Pump House) Replacement. ....		WP 0407
Power Distribution Box Control Panel (Pump House) Replacement .....		WP 0408
Power Cable Assembly (SINCGARS) Replacement .....		WP 0409
Pressure Regulator Replacement .....		WP 0410
Pressure Transducer Replacement .....		WP 0411
Pump House Distribution Box Circuit Breaker Replacement .....		WP 0412
Pump House Distribution Box Relay Replacement .....		WP 0413



**TABLE OF CONTENTS (CONTINUED)**

	<u>Page No.</u>	<u>WP Sequence No.</u>
Pump House Cooling Fan Temperature Switch Replacement . . . . .		WP 0414
Pump House Heater Diagnostic Module Replacement . . . . .		WP 0415
Pump House Cooling Fan Replacement . . . . .		WP 0416
Pump Operator’s Panel Electric Valve Control/Meter Replacement . . . . .		WP 0417
Pump Operator’s Panel Electric Valve Control Replacement . . . . .		WP 0418
Pump Primer Motor Diode Pack Replacement . . . . .		WP 0419
Rear Step Buzzer Button and Cable Replacement . . . . .		WP 0420
Rear Step Buzzer Button Compartment Replacement . . . . .		WP 0421
Remote Intercom Replacement. . . . .		WP 0422
Roof, Bumper, and Pump Cooler Dump-To-Ground Junction Box Replacement . . . . .		WP 0423
Roof Turret Control Valve Replacement . . . . .		WP 0424
Shoreline Inlet Receptacle Replacement . . . . .		WP 0425
Shutoff Control Valve Diode Pack Replacement. . . . .		WP 0426
Shutoff Control Valve Manifold Replacement . . . . .		WP 0427
Speaker Replacement . . . . .		WP 0428
Terminal Block (Pass-Through) Replacement. . . . .		WP 0429
Two-Way Radio Replacement. . . . .		WP 0430
Utility Outlet Replacement . . . . .		WP 0431
Windshield Deluge Motor Replacement . . . . .		WP 0432
Air Conditioner Controller Wire Harness Replacement . . . . .		WP 0433
Air Conditioner Electric Motor Wire Harness Replacement . . . . .		WP 0434
Air Conditioner Rear Wire Harness Replacement. . . . .		WP 0435
Body Air Condenser Wire Harness Replacement . . . . .		WP 0436
Bumper Turret Wire Harness Replacement. . . . .		WP 0437
Cab Discharge Digital Pressure Gauge Wire Harness Replacement . . . . .		WP 0438
Cab Foam A and Foam B Tank Level Indicator Wire Harness Replacement . . . . .		WP 0439
Cab Instrument Panel Wire Harness Replacement. . . . .		WP 0440
Cab Power Distribution Wire Harness and Block Replacement . . . . .		WP 0441
Cab Roof Wire Harness Replacement. . . . .		WP 0442
Cab Pump Control Wire Harness Replacement . . . . .		WP 0443
Cab Water Tank Level Indicator Wire Harness Replacement . . . . .		WP 0444
Crew Cab Intercom Wire Harness Replacement. . . . .		WP 0445

**TABLE OF CONTENTS (CONTINUED)**

	<u>Page No.</u>	<u>WP Sequence No.</u>
Crew Cab Wire Harness Replacement . . . . .		WP 0446
Direct Tank Fill Valve Wire Harness Replacement . . . . .		WP 0447
Driver Side Body Wire Harness Replacement . . . . .		WP 0448
Equipment (Ladder) Rack Control Wire Harness Replacement . . . . .		WP 0449
Evaporator Wire Harness Replacement . . . . .		WP 0450
Flow Sensor Wire Harness Replacement . . . . .		WP 0451
Foam Tank Level Probe Wire Harness Replacement . . . . .		WP 0452
Inlet, Discharge, and Tank Fill and Re-Circulating Control Valve Wire Harness Replacement . . . . .		WP 0453
Intercom Wire Harness Replacement . . . . .		WP 0454
Main Wire Harness Replacement . . . . .		WP 0455
Passenger Side Body Wire Harness Replacement . . . . .		WP 0456
Pump House Power Distribution Wire Harness and Block Replacement . . . . .		WP 0457
Pump House Wire Harness Replacement . . . . .		WP 0458
Pump Operator's Panel Wire Harness Replacement . . . . .		WP 0459
Pressure Transducer Wire Harness Replacement . . . . .		WP 0460
Rear Body Wire Harness Replacement . . . . .		WP 0461
SINCGARS and Two-Way Radio Intercom Cable Replacement . . . . .		WP 0462
Valve Control Wire Harness Replacement . . . . .		WP 0463
Water Pump Engine Wire Harness Replacement . . . . .		WP 0464
Water Valve Wire Harness Replacement . . . . .		WP 0465
Water Tank Level Probe Wire Harness Replacement . . . . .		WP 0466
<b>HEATER, VEHICULAR COMPARTMENT</b>		
Heater Fuel Pumps Replacement . . . . .		WP 0467
Heater Fuel Tank Pickups Replacement . . . . .		WP 0468
Pump House Heater Replacement . . . . .		WP 0469
Rear Compartment Heater Diagnostic Module Replacement . . . . .		WP 0470
Rear Compartment Heater Replacement . . . . .		WP 0471
Rear Heater Thermostat Replacement . . . . .		WP 0472
<b>WATER PUMP ENGINE COOLING ASSEMBLY</b>		
Water Pump Engine Coolant/Fuel Pump Belts Replacement . . . . .		WP 0473
Water Pump Engine Coolant Level Sensor Replacement . . . . .		WP 0474
Water Pump Engine Coolant Level Sight Glass Replacement . . . . .		WP 0475

**TABLE OF CONTENTS (CONTINUED)**

	<u>Page No.</u>	<u>WP Sequence No.</u>
Water Pump Engine Coolant Hoses and Tubes Replacement . . . . .		WP 0476
Water Pump Engine Coolant Pump Replacement. . . . .		WP 0477
Water Pump Engine Cooling System Pressure Test. . . . .		WP 0478
Water Pump Engine Cooling System Service . . . . .		WP 0479
Water Pump Engine Coolant Temperature Sensor Replacement. . . . .		WP 0480
Water Pump Engine Radiator Replacement . . . . .		WP 0481
<b>PIPING, WATER AND FOAM</b>		
Bumper Turret Valve Replacement . . . . .		WP 0482
Coupling Replacement . . . . .		WP 0483
Main Inlet Valve (Driver Side) Replacement . . . . .		WP 0484
No. 1 Discharge Valve (Driver Side) Replacement . . . . .		WP 0485
No. 2 Discharge Valve (Driver Side) Replacement . . . . .		WP 0486
No. 3 Discharge Valve (Passenger Side) Replacement . . . . .		WP 0487
No. 4 Discharge Valve (Passenger Side) Replacement . . . . .		WP 0488
Piping Assembly (Pipe Thread Sealing Compound) . . . . .		WP 0489
Plumbing, Hoses, and Piping Replacement . . . . .		WP 0490
Table 1. Water Intake System. . . . .	0490-3	
Table 2. Foam and Water Tank Fill Systems. . . . .	0490-5	
Table 2. Foam and Water Tank Fill Systems. (Continued) . . . . .	0490-7	
Table 3. Side Discharge System. . . . .	0490-9	
Table 4. Pre-Connect System. . . . .	0490-11	
Table 5. Roof and Bumper Turret Systems. . . . .	0490-13	
Table 6. Ground Sweeps and Thermal Relief Systems. . . . .	0490-15	
Table 7. Windshield Deluge System. . . . .	0490-17	
Table 8. Priming System. . . . .	0490-19	
Pressure Reducing Valve Driver Pre-Connect "A" Replacement . . . . .		WP 0491
Pressure Reducing Valve Driver Pre-Connect "B" Replacement . . . . .		WP 0492
Tank-To-Pump Intake Valve (Driver Side) Replacement. . . . .		WP 0493
Tank-To-Pump Intake Valve (Passenger Side) Replacement. . . . .		WP 0494
Valve Driver Pre-Connect "A" Replacement . . . . .		WP 0495
Valve Driver Pre-Connect "B" Replacement . . . . .		WP 0496

**TABLE OF CONTENTS (CONTINUED)**

	<u>Page No.</u>	<u>WP Sequence No.</u>
<b>SPECIAL PURPOSE BODY</b>		
Air Lift Bag Storage Box Replacement . . . . .	WP 0497	
Air Vent Guard Replacement . . . . .	WP 0498	
Crew Cab Access Panels Replacement . . . . .	WP 0499	
Crew Cab Assembly Replacement . . . . .	WP 0500	
Crew Cab Bench Seat and Access Panel Replacement . . . . .	WP 0501	
Crew Cab Door/Door Hinge Replacement . . . . .	WP 0502	
Crew Cab Door Handle Replacement . . . . .	WP 0503	
Crew Cab Door Latch/Linkage Replacement . . . . .	WP 0504	
Crew Cab Door Seal Replacement . . . . .	WP 0505	
Crew Cab Door Window/Regulator Replacement . . . . .	WP 0506	
Crew Cab Inner Door Panel Replacement . . . . .	WP 0507	
Crew Cab Peep Window Replacement . . . . .	WP 0508	
Crew Cab Rifle Mount(s) Replacement . . . . .	WP 0509	
Crew Cab Roof Hatch Replacement . . . . .	WP 0510	
Crew Cab Roof Hatch Door Switch Guard Replacement . . . . .	WP 0511	
Crew Cab SCBA Seat Replacement . . . . .	WP 0512	
Crew Cab SCBA Seat Repair . . . . .	WP 0513	
Driver Side and Passenger Side Crew Cab Ladder Replacement . . . . .	WP 0514	
Crew Cab Window Replacement . . . . .	WP 0515	
Crew Cab Vent Window Replacement . . . . .	WP 0516	
Cross Divider Replacement . . . . .	WP 0517	
Decal and Data Plate Replacement . . . . .	WP 0518	
Equipment (Ladder) Rack Replacement . . . . .	WP 0519	
Gasoline Can Stowage Compartment Replacement . . . . .	WP 0520	
Grab Handle Replacement . . . . .	WP 0521	
Heater Access Panel Replacement . . . . .	WP 0522	
Hose Restraint Net Replacement . . . . .	WP 0523	
Hose Bed Cover(s) Replacement . . . . .	WP 0524	
Hose Bed Divider Replacement . . . . .	WP 0525	
Hose Bed Grating Replacement . . . . .	WP 0526	
Loose Equipment (Components of End Item) Mounting Bracket(s) Replacement . . .	WP 0527	

**TABLE OF CONTENTS (CONTINUED)**

	<u>Page No.</u>	<u>WP Sequence No.</u>
On-Board Tool Mounting Bracket(s) Replacement . . . . .		WP 0528
Passenger Seat Mount Replacement . . . . .		WP 0529
Passenger Seat Replacement . . . . .		WP 0530
Personnel Cab Rifle Mount(s) and Door Strap(s) Replacement . . . . .		WP 0531
Personnel Cab SCBA Seat Repair . . . . .		WP 0532
Personnel Cab Step Replacement . . . . .		WP 0533
Pneumatic Spring Replacement . . . . .		WP 0534
Power Steering Pump Modification . . . . .		WP 0535
Pre-Connect Nozzle Storage Cups Replacement . . . . .		WP 0536
Pre-Connect Roller Assembly Replacement . . . . .		WP 0537
Pump House Access Doors Replacement . . . . .		WP 0538
Pump House Panel A Open/Close . . . . .		WP 0539
Pump House Panels Replacement . . . . .		WP 0540
Table 1. Pump House Panels Locations.. . . . .	0540-1	
Pump Operator's Platform Replacement . . . . .		WP 0541
Rear Access Ladder Replacement . . . . .		WP 0542
Rear Compartment Mounting Brackets Replacement . . . . .		WP 0543
Rear Compartment Utility Tilt Tray Replacement . . . . .		WP 0544
Rear Hard Lift Replacement . . . . .		WP 0545
Rear Splash Guard Replacement . . . . .		WP 0546
Rear Work Platform Replacement . . . . .		WP 0547
Roof Turret Plumbing Cover Replacement . . . . .		WP 0548
SCBA Seat Belt Replacement . . . . .		WP 0549
Skid Plate Grille Replacement . . . . .		WP 0550
Small Compartment Doors Replacement . . . . .		WP 0551
Spreader Bar Bracket Replacement . . . . .		WP 0552
Stowage Box Replacement . . . . .		WP 0553
Stowage Compartment Door Latch Replacement . . . . .		WP 0554
Stowage Compartment Door Replacement . . . . .		WP 0555
Threaded Screw Insert Replacement . . . . .		WP 0556
Table 1. Threaded Screw Insert Replacement Parts. . . . .	0556-1	
Top Stowage Compartment Door Replacement . . . . .		WP 0557

**TABLE OF CONTENTS (CONTINUED)**

	<u>Page No.</u>	<u>WP Sequence No.</u>
Transmission Replacement . . . . .		WP 0558
Transmission Dipstick and Tube Replacement . . . . .		WP 0559
Wheel Chocks Stowage Compartment Replacement . . . . .		WP 0560
Windshield Deluge Pump House Strainer Screen Replacement . . . . .		WP 0561
Windshield Deluge System Replacement . . . . .		WP 0562
Wire Rope Replacement . . . . .		WP 0563

**VOLUME 4**

**CHAPTER 5 FIELD LEVEL MAINTENANCE (CONTINUED)**

**MOUNTING BRACKETS, FUEL TANK, AND AIR TANK, AND AIR RESERVOIR**

Fuel Tank Brackets Replacement . . . . .		WP 0564
Roof Turret Mounting Plate Replacement . . . . .		WP 0565
Turret Bumper Mount Replacement . . . . .		WP 0566

**FIXED FIREFIGHTING EQUIPMENT**

Air Lines and Fittings Replacement . . . . .		WP 0567
Table 1. Air Supply Air Lines. . . . .	0567-4	
Table 2. Bumper Turret Braided Air Lines. . . . .	0567-4	
Table 3. Roof, Bumper, and Pump Cooler Dump to Ground Valve Air Lines. . . . .	0567-4	
Table 4. Shutoff Control Valve Manifold and Valve Air Lines. . . . .	0567-6	
Table 5. Foam Metering Control Valve Manifold to Shutoff Control Valve Manifold and Multi-metering Valve Air Lines. . . . .	0567-9	
Bumper and Roof Turret Manifold Block Replacement . . . . .		WP 0568
Bumper Turret Replacement . . . . .		WP 0569
Bumper Turret Control Replacement . . . . .		WP 0570
Bumper Turret Repair. . . . .		WP 0571
Bumper Turret Junction Box Replacement. . . . .		WP 0572
Bumper Turret Junction Box Repair . . . . .		WP 0573
Foam Cover and Water Tank Vent Replacement. . . . .		WP 0574
Ground Sweeps Replacement . . . . .		WP 0575
Ground Sweeps Valve Replacement . . . . .		WP 0576

**TABLE OF CONTENTS (CONTINUED)**

	<u>Page No.</u>	<u>WP Sequence No.</u>
Pre-Connects Replacement .....		WP 0577
Pump Cooler (Dump-To-Ground) Valve Replacement .....		WP 0578
Roof Turret, Automatic Drain Valve, and Controls Replacement .....		WP 0579
Roof Turret Valve Replacement .....		WP 0580
Roof Turret and Controls Repair .....		WP 0581
Windshield Deluge Shutoff Valve and Strainer Assembly Replacement .....		WP 0582
<b>HYDRAULIC GENERATOR ASSEMBLY</b>		
Hydraulic Generator Cables Replacement .....		WP 0583
Hydraulic Generator Compensator Replacement .....		WP 0584
Hydraulic Generator Digital Display Module Replacement .....		WP 0585
Hydraulic Generator Hoses Replacement .....		WP 0586
Table 1. Hydraulic Generator System Hoses .....	0586-3	
Hydraulic Generator Oil Cooler Fan Replacement .....		WP 0587
Hydraulic Generator Oil Drain/Fill .....		WP 0588
Hydraulic Generator Oil Filter Replacement .....		WP 0589
Hydraulic Generator Oil Filter Base Replacement .....		WP 0590
Hydraulic Generator Motor Replacement .....		WP 0591
Hydraulic Generator Replacement .....		WP 0592
Hydraulic Generator Reservoir Boost Unit Assembly Replacement .....		WP 0593
Hydraulic Generator Reservoir Breather Replacement .....		WP 0594
Hydraulic Generator Reservoir Fluid Level Gauge Replacement .....		WP 0595
Hydraulic Generator Reservoir Replacement .....		WP 0596
Hydraulic Generator Reservoir Strainer Replacement .....		WP 0597
Hydraulic Generator Reservoir Temperature Sensor Replacement .....		WP 0598
Hydraulic System Bleed .....		WP 0599
Power Take Off (PTO) Replacement .....		WP 0600
Power Take Off (PTO) Pump Replacement .....		WP 0601
Power Take Off (PTO) Solenoid and Pressure Switch Replacement .....		WP 0602

**TABLE OF CONTENTS (CONTINUED)**

	<u>Page No.</u>	<u>WP Sequence No.</u>
<b>MISCELLANEOUS WINTERIZATION EQUIPMENT</b>		
Crew Cab Insulation Replacement . . . . .		WP 0603
Heat Trace Junction Box Replacement . . . . .		WP 0604
Heat Trace Thermostat Replacement . . . . .		WP 0605
Piping Heat Trace Replacement. . . . .		WP 0606
Plumbing Insulation Replacement . . . . .		WP 0607
<b>TECHNICAL SUPPORT</b>		
Illustrated List of Manufactured Items. . . . .		WP 0608
Table 1. Chain. . . . .	0608-2	
Torque Limits . . . . .		WP 0609
Table 1. Torque Limits for Wet Flange Nuts. . . . .	0609-3	
Table 2. Torque Limits for Wet Socket Head Capscrews. . .	0609-3	
Table 3. Torque Limits for Dry Fasteners. . . . .	0609-5	
Table 4. Torque Limits for Wet Fasteners. . . . .	0609-6	
Table 5. Torque Limits for SAE 37-Degree Flare Hose Connections. . . . .	0609-7	
Table 6. Torque Limits for SAE 45-Degree Flare Hose Connections. . . . .	0609-7	
Table 7. Torque Limits for ORS Preformed Packing Face Seal Hose Connections. . . . .	0609-8	
Table 8. Torque Limits for NPSM Swivel Connections. . . . .	0609-8	
<b>CHAPTER 6 PARTS INFORMATION</b>		
Repair Parts and Special Tools List (RPSTL) Introduction. . . . .		WP 0610
Table 1. SMR Code Explanation. . . . .	0610-2	
Table 2. Source Code Explanation. . . . .	0610-2	
Table 3. Third Position Maintenance Code Explanation. . . .	0610-3	
Table 4. Fourth Position Maintenance Code Explanation. . .	0610-4	
Table 5. Recoverability Code Explanation. . . . .	0610-4	
Function Group Code 07 - Transmission . . . . .		WP 0611
Function Group Code 12 - Brakes . . . . .		WP 0612
Function Group Code 34 - Armament and Sighting and Fire Control Materiel . . . . .		WP 0613
Function Group Code 52 - Refrigeration and Air Conditioning Components. . . . .		WP 0614
Function Group Code 76 - Firefighting Equipment Components . . . . .		WP 0615



**TABLE OF CONTENTS (CONTINUED)**

	<u>Page No.</u>	<u>WP Sequence No.</u>
Function Group Code 94 - Repair Kits . . . . .		WP 0616
Function Group Code 95 - General Use Standardized Parts . . . . .		WP 0617
RPSTL NSN Index. . . . .		WP 0618
RPSTL Part Number Index . . . . .		WP 0619
<b>CHAPTER 7 SUPPORTING INFORMATION</b>		
References . . . . .		WP 0620
Maintenance Allocation Chart (MAC) Introduction. . . . .		WP 0621
Maintenance Allocation Chart (MAC) . . . . .		WP 0622
Table 1. Two-Level Maintenance Allocation Chart for TFFT. 0622-1		
Table 2. Tools and Test Equipment for TFFT. . . . . 0622-21		
Table 3. Remarks for TFFT. . . . . 0622-22		
Components of End Item (COEI) and Basic Issue Items (BII). . . . .		WP 0623
Table 1. Components of End Item. . . . . 0623-2		
Table 2. Basic Issue Items. . . . . 0623-17		
Additional Authorization List (AAL) . . . . .		WP 0624
Table 1. Additional Authorization List. . . . . 0624-2		
Expendable Supplies and Materials List . . . . .		WP 0625
Table 1. Expendable and Durable Supplies and Materials List. . . . . 0625-1		
<b>ALPHABETICAL INDEX . . . . .</b>		<b>INDEX-1</b>

## HOW TO USE THIS TECHNICAL MANUAL

This manual is designed to help operate and maintain the Tactical Fire Fighting Truck (TFFT). This technical manual should be used in conjunction with the TM 9-2320-347-10 and TM 9-2320-325-14&P series manuals. Listed below are some of the features included in this manual to help locate and use the needed information:

- Warnings, cautions, subject headings, and other essential information are printed in bold type, making them easier to see.
- In addition to text, there are illustrations showing how to take a component off and put it back on. Cleaning and inspection criteria are also included where necessary.

This manual is subdivided into four volumes containing the following:

### Volume 1

- Chapter 1 of this manual supplements the TM 9-2320-347-10 manual and it describes the TFFT specific components. Equipment data is also provided.
- Chapter 2 of this manual supplements the TM 9-2320-347-10 manual and provides TFFT Operating Instructions.
- Chapter 3 of this manual supplements the TM 9-2320-325-14&P manual and provides TFFT Operator and Field Level Troubleshooting Procedures for Refrigeration and Air Conditioning Components, Fire Pump System, Foam Proportioner System, and Water Tank Assembly.

### Volume 2

- Chapter 3 (continued) of this manual supplements the TM 9-2320-325-14&P manual and provides TFFT Field Level Troubleshooting Procedures for Instrument Housing Assembly, Siren Assembly, Warning Light Assembly, Spotlights, Dome and Engine Light Assembly, Miscellaneous Electrical Components, and Heater, Vehicular Compartment.
- Chapter 4 of this manual supplements the TM 9-2320-325-14&P manual and provides TFFT Preventive Maintenance Checks and Services (PMCS) and Lubrication Instructions.
- Chapter 5 of this manual supplements the TM 9-2320-325-14&P manual and provides Field Level Maintenance Instructions for Adjustments and Alignments on the TFFT, as well as Removal/Installation Instructions for Refrigeration and Air Condition Components, Brake System Maintenance, Fire Pump Assembly, Relief Valve Assembly, Primer Pump Assembly, Drain Valve Assembly, and Foam System Assembly.

### Volume 3

- Chapter 5 (continued) of this manual supplements the TM 9-2320-325-14&P manual and provides TFFT Field Level Maintenance Removal/Installation Instructions Water Tank Assembly, Instrument Housing Assembly, Siren Assembly, Warning Light Assembly, Spotlights, Dome and Engine Assembly, Miscellaneous Electrical components, Heater, Vehicular Compartment, Water Pump Engine Cooling Assembly, Piping, Water and Foam, and Special Purpose Body.

### Volume 4

- Chapter 5 (continued) of this manual supplements the TM 9-2320-325-14&P manual and provides TFFT Field Level Maintenance Removal/Installation Instructions Mounting Brackets, Fuel Tank, Air Tank, and Air Reservoir, Fixed Firefighting Equipment, Hydraulic Generator Assembly, and Miscellaneous Winterization Equipment. An Illustrated List of Manufactured Items and Torque Limits are provided at the rear of this chapter.

- Chapter 6 of this manual supplements the TM 9-2320-325-14&P manual and provides Repair Parts and Special Tools List (RPSTL) for the TFFT.
- Chapter 7 of this manual supplements the TM 9-2320-325-14&P manual and provides References, Two-Level Maintenance Allocation Chart (MAC), Components of End Item (COEI) and Basic Issue Items (BII) Lists, Additional Authorization list (AA), and Expendable and Durable Supplies and Material Lists. An Alphabetical Index is provided to help locate items in the text.

The vehicles referenced in the TM 9-2320-347-10 and TM 9-2320-325-14&P manuals are similar, but not identical to the vehicle referenced in the supplemental manual. TFFT vehicle procedures that are common to the M977A2 can be found in the TM 9-2320-347-10 or TM 9-2320-325-14&P manual. Configuration differences can be determined by visually inspecting the vehicle prior to maintenance.

Follow these guidelines when using the manual:

- Read all WARNINGS and CAUTIONS before performing any procedure.
- The operator must read this technical manual along with TM 9-2320-347-10 manual and become familiar with the content of each manual before attempting to operate the vehicle.
- Maintenance personnel must read this technical manual along with TM 9-2320-325-14&P manual and become familiar with the content of each manual before performing any maintenance to the vehicle.



## **CHAPTER 1**

### **GENERAL INFORMATION AND DATA**



---

**OPERATOR MAINTENANCE****GENERAL INFORMATION**

---

**SCOPE****a. Type of Manual.**

This manual is used for operation, troubleshooting, and operator-performed maintenance of the M1142 Tactical Fire Fighting Truck (TFFT). The TFFT is built on a Heavy Expanded Mobility Tactical Truck (HEMTT) M977A2 Chassis. Refer to TM 9-2320-347-10 for a description of all other models of the M977A2 series vehicle.

**b. Model/Name.**

M1142 Tactical Fire Fighting Truck (TFFT).

**c. Purpose of Equipment.**

The Tactical Fire Fighting Truck has a 66,000 lb. (29,964 kg) GVWR. The TFFT is equipped with the equipment necessary to extinguish aircraft, petroleum, brush, wildland, and structural fires at isolated military installations.

The TFFT is not designed to tow a trailer.

The TFFT is equipped with a water cooled, Deutz water pump engine and Darley pump; bumper turret; roof turret; four ground sweeps; pump house; pump operator's panel; and cab instrument panels. The equipment body of the TFFT is equipped with 11 body stowage compartments (WP 0002).

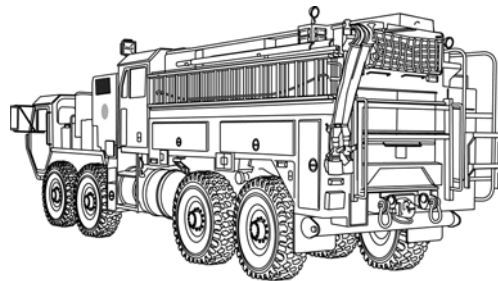

**LEFT REAR VIEW**

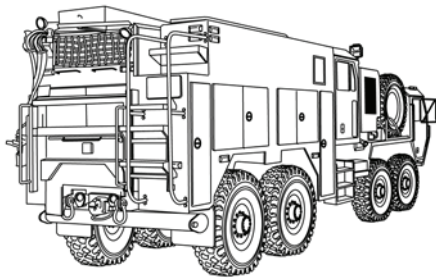

**RIGHT REAR VIEW**

**Figure 1. M1142 Tactical Fire Fighting Truck.**

---

## **MAINTENANCE FORMS, RECORDS, AND REPORTS**

Department of the Army forms and procedures used for equipment maintenance will be those prescribed by DA PAM 750-8, The Army Maintenance Management System (TAMMS).

## **REPORTING EQUIPMENT IMPROVEMENT RECOMMENDATIONS (EIR)**

The quarterly Equipment Improvement Report and Maintenance Digest, TB 43-001 series contains valuable field information on equipment covered in this manual. Information in the TB 43-001 series is compiled from some of the Equipment Improvement Reports prepared on vehicles covered in this manual. Many of these articles result from comments, suggestions, and improvement recommendations that were submitted to the EIR program. The TB 43-001 series contains information on equipment improvements, minor alterations, proposed Modification Work Orders (MWOs), warranties (if applicable), actions taken on some of the DA form 2028s (Recommended Changes to Publications). Refer to TM 43-001 series periodically for the most current and authoritative information on the equipment. The information will help to do a better job and will advise of the latest changes to this manual. Also refer to DA Pam 25-30, Consolidated Index of Army Publications and Blank Forms, and WP 0620, References, of this manual.

## **CORROSION PREVENTION AND CONTROL**

Corrosion Prevention and Control (CPC) of Army materiel is a continuing concern, particularly since the TFFT usually operates in a wet environment. It is important that any corrosion problems be reported so they can be corrected and improvements can be made to prevent problems in the future.

While corrosion is typically associated with the rusting of metals, it can also include deterioration of other materials, such as rubber and plastic. Unusual cracking, softening, swelling, or breaking of these materials may be a corrosion problem.

If a corrosion problem is identified, it should be reported to your supervisor.

## **DESTRUCTION OF ARMY MATERIAL TO PREVENT ENEMY USE**

Refer to TM 750-244-6, Procedures for Destruction of Tank Automotive Equipment to Prevent Enemy Use.

## **DEMOLITION BY MECHANICAL MEANS**

Use hammers, crowbars, picks, or other tools which may be available to destroy the engine block, manifold, water pump, and electrical controls.

## **DEMOLITION BY MISUSE**

Perform the following steps to render the TFFT vehicle inoperative.

- Drain radiator and crankcase. Place sand, nuts, bolts or broken glass into radiator opening, oil fill tube, and fuel tank.
- Disconnect radiator fan and run engine at full throttle.



**WARRANTY INFORMATION**

Pierce Manufacturing Inc. warrants each piece of new fire or rescue apparatus to be free from defects in materials or workmanship under normal use and service for a period of thirteen (13) months from the date of shipment. Our obligation under this warranty is limited to repairing or replacing, as the company may elect, any defective part or parts free of charge to the original purchaser. Pierce Manufacturing reserves the right to request and examine defective parts.

This warranty will not apply to:

1. Normal maintenance and adjustments.
2. Any vehicle which; has been repaired or altered outside of our factory in any way to affect the stability; has been subject to misuse, neglect, or accident; or loaded beyond the factory rated load capacity.
3. Commercial chassis and associated equipment furnished with the chassis, signaling devices, generators, batteries, or other trade accessories in which they are usually warranted separately by their respective manufacturers.

This warranty is in lieu of all other warranties, expressed or implied, all other representations to the original purchaser and all other obligations or liabilities, including liability for incidental or consequential damages on the part of the company. Pierce Manufacturing Inc. neither assumes or authorizes any other person to give or assume any other warranty or liability on the company's behalf unless made or assumed in writing by the company.

Pierce manufacturing Inc. follows ASTM D 6210 and ASTM D 6211 in regard to coolant specification on this equipment. Use of ASTM D 6210 or ASTM D 6211 compliant coolant and a fully formulated coolant mix, meaning with proper SCA (supplemental coolant additive) blending is **required** during the warranty period. Failure to follow the OEM specification for a fully formulated and compliant coolant during the warranty period will affect the engine warranty on this vehicle. See TB 750-651 (para 2).

Questions concerning the TFFT warranty can be submitted to Pierce Manufacturing Inc. via e-mail at [contactcenter@piercemfg.com](mailto:contactcenter@piercemfg.com) or by calling 1-888-YPIERCE (1-888-974-3723).

**NOMENCLATURE CROSS-REFERENCE LIST**

<b>Common Name</b>	<b>Official Nomenclature</b>
cable . . . . .	wire rope
engine coolant . . . . .	antifreeze, ethylene glycol mixture
equipment rack . . . . .	equipment (ladder) rack
foam concentrate . . . . .	foam agent

**LIST OF ABBREVIATIONS/ACRONYMS**

amp	amperage
C	Celsius
CAGE	Commercial and Government Entity
cm	centimeters
dB	decibel
ECU	Electronic Control Unit
F	Fahrenheit
ft.	feet
gal.	gallon(s)
GPM	Gallons per Minute
GVWR	Gross Vehicle Weight Rating
HEMTT	Heavy Expanded Mobility Tactical Truck
HP	Horsepower
in.	inch
kg	kilogram
kPa	kilo pascal
kW	kilowatt
l	liter
lb.	pound(s)
l/min.	liters per Minute
m	meter(s)
mm	millimeter
MOPP	Mission Oriented Protective Posture
NFPA	National Fire Protection Association
NPSM	National Pipe Straight Mechanical
ORS	O-Ring Seal
PMCS	Preventative Maintenance Checks and Services
psi	pounds per square inch
PTO	Power Take Off
PTT	Push To Talk
qt.	quart
rpm	revolutions per minute
RPSTL	Repair Parts and Special Tools List
SCBA	Self-Contained Breathing Apparatus
TFFT	Tactical Fire Fighting Truck
VAC	Voltage Alternating Current
VDC	Voltage Direct Current
V	Volt(s)
W	Watt(s)
WP	Work Package
SINGARS	Single Channel Ground and Airborne Radio System

## LIST OF WARNING ICONS/DESCRIPTIONS



**ELECTRICAL** - electrical wire to arm with electricity symbol running through human body shows that shock hazard is present.



**ELECTRICAL** - electrical wire to hand with electricity symbol running through hands shows that shock hazard is present.



**FALLING PARTICLES** - arrow bouncing off human shoulder and head shows that falling parts present a danger to life or limb.

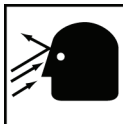

**FLYING PARTICLES** - arrows bouncing off face with face shield shows that particles flying through the air will harm face.



**HEAVY OBJECT** - human figure stooping over heavy object shows physical injury potential from improper lifting technique.



**HEAVY PARTS** - hand with heavy object on top shows that heavy parts can crush and harm.



**HEAVY PARTS** - foot with heavy object on top shows that heavy parts can crush and harm.



**HEAVY PARTS** - heavy object on human figure shows that heavy parts present a danger to life or limb.



**HEAVY PARTS** - heavy object pinning human figure against wall shows that heavy, moving parts present a danger to life or limb.



**HOT AREA** - hand over object radiating heat shows that part is hot and can burn.



**MOVING PARTS** - human figure with an arm caught between gears shows that the moving parts of the equipment present a danger to life or limb.



**SLICK FLOOR** - wavy line on floor with legs prone shows that slick floor presents a danger for falling.



**EXPLOSION** - rapidly expanding symbol shows that the material may explode if subjected to high temperatures, sources of ignition, or high pressure.



**EYE PROTECTION** - person with goggles shows that the material will injure the eyes.



**FIRE** - flame shows that a material may ignite and cause burns.



**VAPOR** - human figure in a cloud shows that material vapors present a danger to life or health.



**FIRE EXTINGUISHER** - shows that material may ignite and a fire extinguisher should be in easy reach.



**STAY CLEAR OF VEHICLE** - person run over by vehicle shows that moving vehicle presents a danger to life and limb.



**SKIN IRRITATION** - a hand radiating shows that material can cause skin irritation.



**TIRE BLOW-OUT** - tire with hole shows that over or under inflated tire may rupture, presenting a danger to life or limb.



**WHIPPING HOSE** - whipping hose hitting personnel shows that air or hydraulic hoses removed while under pressure present a danger to life and limb.



**COLD AREA** - hand over object with ice hanging shows that part is extremely cold to touch.



**WARNING/CAUTION** - shows that a **WARNING** or **CAUTION** is present, and extra safety measures should be taken.

**QUALITY OF MATERIAL**

Material used for replacement, repair, or modification must meet the requirements of this technical manual. If quality of material requirements are not stated in this manual, the material must meet the requirements of the drawings, standards, specifications, or approved engineering change proposals applicable to the subject equipment.

**REPAIR PARTS**

Repair parts are listed and illustrated in WP 0614 and WP 0615 of this technical manual.

**END OF WORK PACKAGE**

---

**OPERATOR MAINTENANCE**  
**EQUIPMENT DESCRIPTION AND DATA**

---

**EQUIPMENT CHARACTERISTICS, CAPABILITIES, AND FEATURES****a. *Equipment Characteristics.***

The M1142 vehicle is a Tactical Fire Fighting Truck capable of extinguishing aircraft, petroleum, brush, wildland, and structural fires at isolated military installations.

The M1142 is built on a modified M977A2 chassis. The modifications made to the M977A2 chassis are:

1. The location of the HEMTT air compressor & hydraulic pump have been reversed, in order to accept the new Power Take Off (PTO).
2. Fuel tank and chassis batteries have been lowered slightly to allow room for the crew cab.
3. A mounting bracket has been added on front of cab for bumper turret.
4. Personnel cab roof has been modified to accept lightbars and turret.

**b. *Capabilities.***

1. **Water Pump.** A 1,000 GPM Darley PSE single stage pump, engine driven, centrifugal type. The pump delivers the percentage of rated discharge at pressure indicated below. Water system controls are labeled with black letters on a gray background.
  - 100% of rated capacity at 150 psi (1,034 kPa) net pump pressure.
  - 70% of rated capacity at 200 psi (1,379 kPa) net pump pressure.
  - 50% of rated capacity at 250 psi (1,724 kPa) net pump pressure.

Pump body is fine-grained gray iron, bronze fitted. Impeller is a high strength bronze alloy accurately balanced and splined to pump shaft for precision fit and durability. A double seal ring design helps to minimize end thrust. Deep groove radial type oversize ball bearings are used. Bearings are protected at the openings from road dirt and water with an oil seal and a water slinger.

2. **Foam System (Class A & B).** An "around-the-pump" foam proportioner is located on the intake side of the pump.

The foam system is plumbed to two foam tanks with a foam valve and check valve in each foam line.

A multi-metering valve arrangement is provided for discharges controlled inside the personnel cab. Turrets and ground spray nozzles are preset for 3% AFFF for Class B foam and 1% for Class A foam.

An adjustable metering valve located on the pump operator's panel allows the operator to select the proper setting at any flow within the operating range for the six discharges. Each discharge will be proportioned at the same rate.

Controls for the foam system are located on the pump operator's panel and are labeled with red letters on a white background for easy identification. Controls for eductor, foam supply, and flush, are electric over pneumatic to allow for an ergonomically designed control panel and simplified operation.

All piping coming in direct contact with the foam agent is immune to the agent; so deterioration of plumbing is avoided.

This system is designed to operate at no more than 5 psi (34 kPa) on the suction side of the water pump.

**System Capacity.** The system has the ability to deliver the following minimum foam solution flow rates:

- 500 GPM (1,893 l/min) @ 6%
- 1,000 GPM (3,785 l/min) @ 3%

3. **Generator.** The TFFT is equipped with a complete electrical power system. The generator is a Harrison Model 15.0 MPC-160 TFFT 15 kW Hydraulic unit. The wiring and generator installation conform to present National Electrical Code Standards of the National Fire Protection Association (NFPA). The installation is designed for continuous operation without overheating and placing undue stress on components.

The output of the generator is controlled by an internal hydraulic system. An electrical instrument panel allows for the operator to monitor and control all electrical operations and output. The generator utilizes the main chassis transmission to power the generator. An engine/transmission PTO unit drives the generator, through a hydraulic pump and motor.

An electric/hydraulic valve supplies hydraulic fluid to the clutch engagement unit provided on the chassis PTO drive.

4. **Generator Instruments and Controls.** To properly monitor the generator performance, a digital meter panel is located in passenger side rear compartment. The meter indicates the following items:
- Voltage
  - Amperage for both lines
  - Frequency
  - Generator run hours
  - Over current indication
  - Over temperature indication
  - Service required indication
  - "Power On" indication
  - Two (2) fuse holders with 2 amp fuses (for indicator light protection)

All instruments are accurate within +/- 2 percent.



---

**c. Features.**

1. **Cabs.** The standard two person HEMTT personnel cab has been retained. The standard HEMTT passenger side seat has been replaced with officer's seat equipped with a SCBA seat back. An additional four-person crew cab has been added, located separate from front cab. The crew cab is constructed of a tubular steel frame and skins and is equipped with air conditioner. Crew cab doors have a roll-up type window.
2. **Cab Pump/Foam System Controls.** An additional pump control panel is located inside the personnel cab, which provides the following:
  - Pump engine start/engine
  - Tank to pump control
  - Water and foam level gauges
  - Foam system controls
  - Windshield deluge system controls
  - Ground Sweeps controls
  - Roof and bumper turret controls
3. **Electrical System.** Like the chassis electrical system, the fire package utilizes a 24-volt electric system. The fuel level sending unit has been updated to accommodate dual gauges at both personnel cab and pump operator's panel locations.
4. **Winterization Package.** A winterization package is provided to allow operation of the pump, foam system, and body down to -25°F (-32°C). The package includes two (2) diesel-fired 27,300 BTU heaters, one inside the pump house compartment and one used to heat the rear compartment. These heaters turn on at around 39°F (4°C), and turn off at 57°F (14°C).

Two (2) 2,250 W water heaters are installed in the water tank. The tank heaters turn on at 40°F (4°C) and turn off at 60°F (16°C). The water pump must be engaged and circulating water to prevent freezing the pump and plumbing. The pump compartment is sealed to reduce heat loss. Some of the plumbing between the water tank to the pump is also heated and insulated.

5. **Pump Drive Engine.** An auxiliary diesel pump drive Deutz engine is provided. The Deutz engine is water-cooled and has 198 HP to drive the water pump sufficiently to meet pump performance.

The Deutz engine draws from the same fuel tank as the chassis.

The Deutz engine has remote start/stop controls.

6. **Inlet/Direct Water Tank Fill.** One 4 in. (10.2 cm) direct water tank fill is provided. The inlet is piped directly from water tank to an external location on the side of the vehicle. An electric over air valve controls the inlet.

The direct water tank inlet includes an automatic water fill system. The system is designed to allow an outside water source to maintain the water tank at full level without having the operator monitor the water tank for an overflow situation.

The inlet includes a 4 in. (10.2 cm) cap and chain.

7. **Handheld Radio Set.** The vehicle is equipped with a set of four two-way, FM handheld, 5 W, 150-174 MHz, Motorola Model M 1250 radios and one cab mounted two-way, VHF, 40 Watt, Motorola CDM-1550, Model No. AAM25KK59AA, 128 channel net base radio. The net base is installed and operational in personnel cab, with all electrical supply and antenna provisions. The radio set is water and heat resistant with programmable channel selection. Each handheld radio is provided with a base recharging unit, which maintains battery charge.
8. **Battery Charger/Air Compressor.** One on-board combination battery charger/air compressor is mounted on the TFFT to maintain electrical charge for the chassis battery system and chassis air system. The charger/compressor is wired to one Kussmaul auto eject mounted on driver side of vehicle and is provided, to operate specified 120 VAC circuits on vehicle without use of the generator.

The specified 120 VAC circuits include the reciprocating saw battery charger receptacle.

A shoreline receptacle is provided with a NEMA 5-20, 120 VAC, 20 amp, straight blade Kussmaul Super auto eject plug with a weatherproof cover. The cover is spring-loaded to close, preventing water from entering when the shoreline is not connected. The unit is completely sealed to prevent road dirt contamination.

A solenoid wired to the vehicle's starter is energized when the engine is started. This instantaneously drives the plug from the receptacle.

An internal switch arrangement is provided to disconnect the load prior to ejections, eliminating arcing of connector contacts.

9. **Cab Access Doors.** The personnel cab doors and crew cab doors open to 90 degrees from closed position to allow safe and fast access for crewmen in full MOPP gear.
10. **Cargo Door Locks.** The personnel cab, crew cab doors, and access compartments include keyed-alike locking latches flush with the body of the vehicle.
11. **Hose Bed Cover.** An aluminum hose bed cover is furnished.
12. **Rear Platform.** The platform provides a horizontal surface to support and accommodate an operator in standing position. Bumper steps are provided as an extension to the platform to provide a step-down to the ground.

Two (2) handrails are installed below the hose bed to aid stability while standing on the platform.
13. **120 VAC Lighting.** The TFFT is equipped with two (2) telescoping lift up Extenda-Lite Model E-500 quartz tube floodlights. Each light head is 120 VAC, W500, draws 4.5 amps, and has an output of 10,500 lumens. Light head swivels 360 degrees left or right and tilts up and down.
14. **One-Way Utility Tray.** A one-way utility tray with a weight capacity rating of 500 lb. (227 kg) maximum, in extended position. The tray dimensions are 46 in. (117 cm) x 36 in. (91 cm) x 3 in. (8 cm). The tray slides out in one direction only; two-thirds (2/3) of its length. The vertical location of tray within the compartment is low and not adjustable. Six ball bearing rollers; each rated for a minimum 500 lb. (227 kg) load, supports the utility tray.
15. **Electric Cord Reel.** Furnished with the electrical system is a Hanney, series 1600, cord reel wired for a four conductor cord. The reel is provided with a 24 V electric rewind switch that is guarded to prevent accidental operation and labeled for its intended use. The push-button switch is protected with a fuse.
16. **Reel Guide.** A ball stop is provided to prevent cord from being wound into the reel.

- 
17. **Roof Turret Discharge.** The personnel cab turret is capable of discharging up to 500 GPM (1,893 l/min) at 210 psi (1,448 kPa). The turret is equipped with a non-aspirated nozzle.

Turret is manually controlled inside the personnel cab.

An electric over air controlled full flow ball valve is used in outlet plumbing with the control located on manual control stick.

18. **Front Bumper Turret Discharge.** A turret is piped to the front bumper of the personnel cab. The turret has a horizontal rotation of 180 degrees and operates from 45 degrees above to 20 degrees below horizontal. Horizontal rotation and automatic oscillation are driven by a 24 VDC direct drive motor/actuator.

Plumbing consists of 2 in. (5 cm) piping and flexible hose with a constant flow 250 GPM (946 l/min) nozzle. A switch for straight or fog pattern is located inside the personnel cab.

Turret is remote controlled from control box located in the center of the personnel cab. A joy stick control is provided for water on/off, monitor left/right, monitor up/down, and straight or fog pattern.

Drains are provided at all low points of piping.

19. **GROUND SWEEPS.** The four (4) ground sweeps located below the vehicle are capable of 1% Class A foam and 3% Class B foam and are controlled inside the personnel cab.

LOCATION AND DESCRIPTION OF MAJOR COMPONENTS

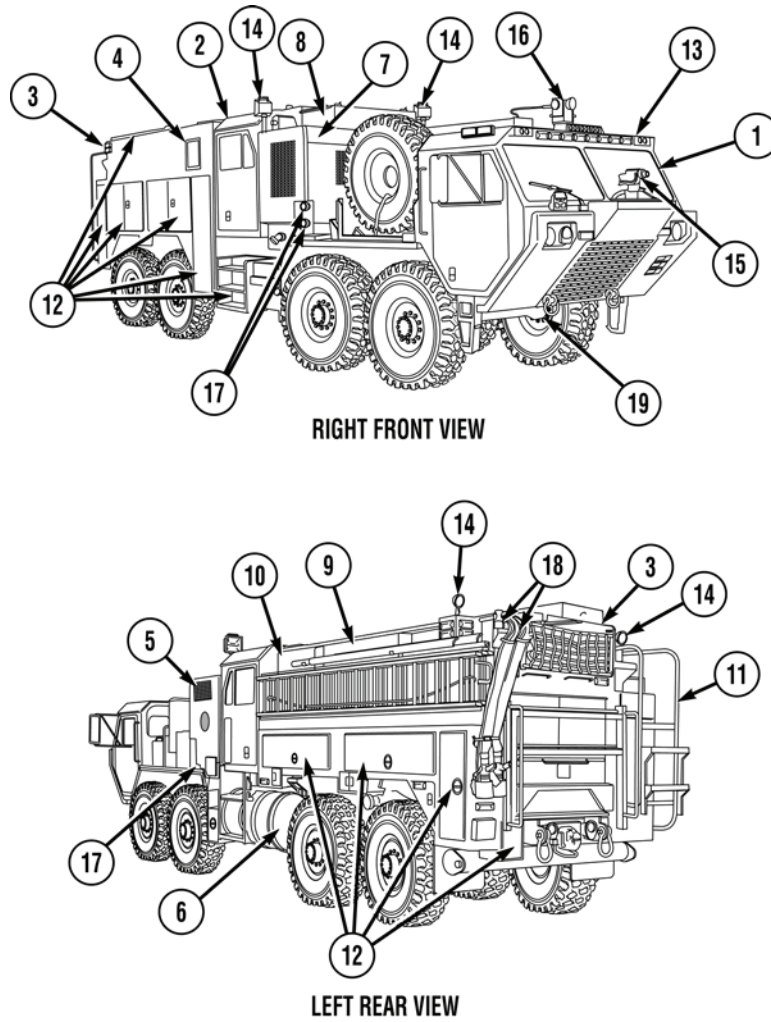

Figure 1. Major Components of the M1142.

*Table 1. Legend for Figure 1.*

Item No.	Description
1	<b>Personnel Cab:</b> Used to transport crew, and houses vehicle control, firefighting controls, gauges, and indicators for firefighting operations.
2	<b>Crew Cab:</b> Used to transport crew, and provides access to pump operator's panel through roof hatch.
3	<b>Equipment Body:</b> Used to carry all BII, COEI, and repair parts.
4	<b>Generator:</b> Used to power the 120/240 VAC system; tank and piping heaters, cord reel, crew cab air conditioner, and work lights.
5	<b>Air Cleaner:</b> Filters out smoke, dust, and debris from entering air induction system for the auxiliary water pump engine.
6	<b>Fuel Tank:</b> Stores fuel used to operate auxiliary water pump engine and two (2) heaters. Receives excess fuel not used by auxiliary water pump engine's fuel injection system.
7	<b>Pump House:</b> Used to house plumbing, auxiliary water pump engine, gauges, and indicators for operation of firefighting apparatus.
8	<b>Pump Operator's Panel:</b> Used by crew to control firefighting apparatus from pump house.
9	<b>Water Tank:</b> Stows water used by the system.
10	<b>Foam Tanks:</b> Stows foam agent used for Class A and Class B fires.
11	<b>Rear Access Ladder:</b> Used by crew to access hoses and generator on top of TFFT equipment body.
12	<b>Stowage Boxes:</b> Eleven (11) stowage boxes used to stow COEI and BII.
13	<b>Warning Lights:</b> Used to indicate fire situation.
14	<b>Extendable Flood Lights/Deck Lights:</b> Used during firefighting operations performed at night.
15	<b>Bumper Turret:</b> Used to extinguish fires. Turret is operated using controls in personnel cab.
16	<b>Roof Turret:</b> Used to extinguish fires. Turret is operated using controls in personnel cab.
17	<b>Side Discharge(s):</b> Used to extinguish fires, four (4) 2.5 in. (6.4 cm) side discharge(s), two (2) on each side.
18	<b>Pre-Connects:</b> Used to extinguish fires, two (2) are pre-connected to 1.75 in. (4.45 cm) hose in the hose bed. Each discharge is restricted to control pressure and volume, while truck is pumping through turrets at maximum flow.
19	<b>GROUND SWEEPS:</b> Four (4) ground sweeps located below the vehicle are capable of 1% class A foam and 3% Class B foam. Ground sweeps are operated using controls in personnel cab.

**EQUIPMENT DATA**

Refer to Table 2 for TFFT M1142 equipment data. Refer to TM 9-2320-347-10 for all equipment data not specified below.

*Table 2. Equipment Data.*

Model	Item
TFFT M1142	<p><b>VEHICLE DIMENSIONS</b></p> <p><b>Width (overall):</b> 102.5 in. (260.4 cm)</p> <p><b>Width (reduced for shipping):</b> 99.5 in. (252.7 cm)</p> <p><b>Height (overall):</b> 132.12 in. (335.58 cm)</p> <p><b>Height (reduced for shipping):</b> 132.12 in. (335.58 cm)</p> <p><b>Length (overall):</b> 428.5 in. (1088.4 cm)</p> <p><b>Wheelbase:</b> 210 in. (533 cm)</p> <p><b>Turning Circle (wall-to-wall):</b> 100 ft. (30.5 m)</p> <p><b>Ground Clearance:</b> 20 in. (51 cm) except 13 in. (33 cm) under center of axles</p> <p><b>Center of Gravity (at curb weight):</b> 60.9 in. (154.7 cm) above ground, 138.2 in. (351 cm) forward of NO. 4 axle centerline, 0.1 in. (0.3 cm) left of center</p>
TFFT M1142	<p><b>GENERATOR DIMENSIONS</b></p> <p><b>Length:</b> 23 in. (58 cm)</p> <p><b>Width:</b> 29 in. (74 cm)</p> <p><b>Height:</b> 19 in. (48 cm)</p> <p><b>Weight:</b> 431 lb. (196 kg)</p>
TFFT M1142	<p><b>WEIGHT</b></p> <p><b>Curb Weight:</b> 52,100 lb. (23,653 kg)</p> <p><b>Gross Vehicle Weight Rating:</b> 66,000 lb. (29,964 kg)</p>
TFFT M1142	<p><b>VEHICLE PERFORMANCE</b></p> <p><b>Maximum Side Slope:</b> 30 percent</p> <p><b>Maximum Ford Depth:</b> 48 in. (122 cm)</p> <p><b>Maximum Grade at GCWR:</b> 60 percent</p> <p><b>Approach Angle:</b> 43 degrees</p> <p><b>Departure Angle:</b> 45 degrees</p>

**Table 2. Equipment Data. (Continued)**

Model	Item
TFFT M1142	<b>GENERATOR</b> <b>Make:</b> Harrison <b>Model:</b> 15.0 MPC-160 TFFT <b>Type:</b> 15 kW Hydraulic Unit <b>Continuous Duty Rating:</b> 15,000 W <b>Nominal V:</b> 120 V <b>Amperage:</b> 125 amps at 120 V; 62.6 amps at 240 V <b>Phase:</b> Single <b>Cycles:</b> 60 hertz <b>Engine Speed at Engagement:</b> Idle <b>RPM Range:</b> 950 to 3,000 RPM (hydraulic pump)
TFFT M1142	<b>CAPACITIES</b> <b>Deutz Engine Oil w/o Filters:</b> 21 qt (20 l) <b>Deutz Engine Oil w/Filters:</b> 22 qt (21 l) <b>Hydraulic Reservoir w/Filters:</b> 31 qt (29 l) <b>Water Tank:</b> 1,000 gal (3,785 l) <b>Fuel Tank:</b> 150 gal (568 l) <b>Foam Tank:</b> 60 gal (227 l) each (Class A, Class B)
TFFT M1142	<b>AUXILIARY ENGINE</b> <b>Make:</b> Deutz <b>Model:</b> BP6M 1013C <b>Type:</b> Water cooled <b>Cylinders:</b> 6 <b>Bore:</b> 108 mm <b>Stroke:</b> 130 mm <b>Displacement:</b> 7.14 l <b>Oil Filter Quantity:</b> 1
TFFT M1142	<b>WATER PUMP</b> <b>Make:</b> Darley <b>Model:</b> Champion PSE <b>Type:</b> PSE Single Stage, Engine Driven, Centrifugal Pump
TFFT M1142	<b>FUEL SYSTEM</b> <b>Type:</b> Diesel Injection <b>Tank Quantity:</b> 1 <b>Air Cleaner Type:</b> Dry-Pleated Paper Filter <b>Element Quantity:</b> 1

**Table 2. Equipment Data. (Continued)**

Model	Item
TFFT M1142	<b>DISCHARGE CAPABILITIES</b> <b>Roof Turret:</b> 500 GPM (1,893 l/min) at 210 psi (1,448 kPa) <b>Bumper Turret:</b> 250 GPM (946 l/min) at 210 psi (1,448 kPa) <b>Side Discharges:</b> 250 GPM (946 l/min) <b>Pre-Connects:</b> 125 GPM (473 l/min)
TFFT M1142	<b>FOAM SYSTEM DISCHARGE CAPABILITIES</b> 500 GPM (1,893 l/min) at 6 percent 1,000 GPM (3,785 l/min) at 3 percent
TFFT M1142	<b>WATER PUMP DISCHARGE PRESSURE</b> <b>100% of Rated Capacity:</b> 150 psi (1,034 kPa) net pump pressure <b>70% of Rated Capacity:</b> 200 psi (1,379 kPa) net pump pressure <b>50% of Rated Capacity:</b> 250 psi (1,724 kPa) net pump pressure
TFFT M1142	<b>ONE-WAY SLIDE OUT UTILITY TRAY</b> <b>Maximum Capacity (Extended):</b> 500 lb. (227 kg)
TFFT M1142	<b>COOLING SYSTEM (DEUTZ ENGINE)</b> <b>Radiator Working Pressure:</b> 7 psi (48 kPa)
TFFT M1142	<b>ELECTRICAL SYSTEM</b> <b>Voltage:</b> 24 <b>Alternator (amps):</b> 130 <b>RFI Suppression Ability:</b> yes
*	<b>AUXILIARY EQUIPMENT</b> Arctic Kit-Engine Gas Particulate Filter Unit Radio Installation Kit  * Vehicle may or may not be equipped with any of these items depending on mission, climate, or other factors.

END OF WORK PACKAGE



---

## OPERATOR MAINTENANCE

### THEORY OF OPERATION

---

#### SYSTEM INTRODUCTION

The TFFT contains the same functional base systems as the M977 vehicles, with some modifications. The TFFT firefighting systems are described in the following paragraphs. Refer to TM 9-2320-347-10 for base M977A2 vehicle systems not contained in this manual.

#### WATER PUMPING SYSTEM

Water pressure is supplied to the water pumping system by a Darley PSE, single stage, engine driven, centrifugal pump. Water flows from the pump discharge manifold to roof turret, bumper turret, ground sweeps, window deluge system, two (2) pre-connect discharges; and two (2) driver side and passenger side discharge valves.

The water pumping system can be operated from both cab instrument panel or pump operator's panel. Controls are interlocked to ensure single operator control. In pump and roll mode, system can only be operated from cab instrument panel. In structural mode, system can be operated from pump operator's panel.

In pump and roll mode, water is supplied to the pump from the water tank. Pump must be disengaged when water tank is emptied.

In structural mode, water is supplied to the pump from either the water tank or alternate source(s). Alternate sources may be fire hydrants, remote pumping units, or an open reservoir. If water is drawn from tank for structural firefighting, water must be continuously supplied through automatic direct tank fill valve.

#### WATER PUMP ENGINE

The water pump engine is a Deutz, six cylinder, turbocharged, auxiliary diesel pump engine. The water pump engine is water-cooled and has 198 HP to drive the water pump. The water pump engine is installed in the pump house in a "crossmount" configuration. This allows for water pump modulation in accordance with NFPA 414 for all vehicle speed ranges, in all directions of travel, without any loss of pump discharge rates and ranges. The water pump engine draws fuel from the chassis fuel tank.

Water pump pressure can be increased or decreased by changing water pump engine RPM.

#### WINDSHIELD DELUGE SYSTEM

Windshield deluge system is operated from cab instrument panel. Nozzles are mounted below windshield and receive fluid from a 24 VDC electric pump. The windshield deluge system draws water from the 1,000 gal (3,785 l) water tank.

## FOAM SYSTEM

An around-the-pump foam system is used. System includes an eductor in the line from the pump discharge to pump intake. Eductor uses a venturi effect to create a vacuum, which draws foam agent into the water stream. A metering valve is placed in the foam line to control injection percentage. Foam is injected into the foam line that will pump foam agent at a percentage set by a metering valve to all discharges.

Foam agent system is broken into two (2) halves: Class A foam and Class B foam. One is an "automatic" valve (multi-metering valve). The other is a manual metering valve. Multi-metering valve is used for the two (2) turret discharges and four (4) ground sweeps, all of which are controlled in the personnel cab. When each respective discharge is opened, a signal will be sent to the multi-metering valve to open the corresponding port, which will have an orifice sized to inject foam at a preset rate, for a pre-determined flow. It is important to note that the roof turret and bumper turret must be run at the same flow every time. The bumper turret must be operated at 250 GPM (946 l/min). The roof turret must be operated at 500 GPM (1,893 l/min). A manual metering valve is used for side and pre-connect discharges, and is located on pump operator's panel. This valve is operated by pump operator, depending on percentage and flow requirements. If flow changes at any point, metering valve must also be adjusted.

Intake pressures higher than 5 psi (34 kPa) are not allowed. To facilitate operating from either a hydrant or from relay pumping, an automatic tank refill will be used. When water level in tank falls below a certain predetermined level, refill valve will open. When water tank is full, refill valve closes. This system allows vehicle to pump continuously from water tank with accurate water/foam concentration levels.

In order to enable simultaneous use of pre-connects and turrets, pressure reducing valves are used on pre-connect lines. Pump will need to maintain a pressure of 210 psi (1,448 kPa) for optimum turret flow and reach. Pressure reducing valves are provided to reduce driver side A and B pre-connects operating pressure to a more manageable pressure of 150 psi (1,034 kPa). 2-1/2 in. (6.4 cm) discharges are not equipped with pressure reducing valves.

A two-tank selector is located inside personnel cab and at pump operator's panel.

Foam system engagement controls are located inside personnel cab and at pump operator's panel.

## CREW CAB

A four-person crew cab is located separate from personnel cab. The crew cab doors open to 90 degrees from closed position to allow safe and fast access for crew members in full MOPP gear.

Seats of crew cab are SCBA type. Seats have a recessed area in each backrest for mounting a SCBA holder with a "knock-down" bracket and collision resistant holding strap that secures a one-hour SCBA provided for each crew member. Provided with every SCBA seat is a padded backrest insert, which can cover SCBA cavity to improve seating comfort when SCBA bottles are not installed in recessed areas. All seats are furnished with three-point shoulder type seat belts with automatic retractors.

Roof of crew cab is equipped with a split-type roof hatch. The roof hatch is used to access pump operator's panel and can also be used for escape. When the split-type roof hatch is opened, it allows operator a 360-degree field of view. Both split-type roof and pump operator's panel cover are secured by a latch when closed, and are released manually to provide additional safety during operations. Floor of crew cab is equipped with drain holes that allow draining of free standing water on cab floor.

## 120/240 VAC HYDRAULIC GENERATOR SYSTEM

The TFFT is equipped with a complete electrical power system. Output of generator is controlled by an internal hydraulic system. An electrical instrument gauge panel (right rear) stowage box is provided for operator to monitor and control all electrical operations and outputs.

Generator utilizes main chassis transmission to power generator. Generator is driven by engine transmission PTO unit, through a hydraulic pump and motor. An electric/hydraulic valve supplies hydraulic fluid to clutch engagement unit provided on chassis PTO drive. Main load center is equipped with circuit breakers rated to load demand. Individual breakers are provided for all on-line equipment to isolate a tripped breaker from affecting any other on-line equipment.

## WINTERIZATION PACKAGE

A winterization package is provided to allow operation of the pump, foam system, and body up to -25°F (-32°C). The package includes two diesel-fired 27,300 BTU heaters, one inside the pump compartment and one used to heat the rear compartment. The heaters turn on at 39°F (4°C).

Two (2) 2,250 W water heaters are installed in the water tank. The tank heaters turn on at 40°F (4°C) and turn off at 60°F (16°C). Some of the plumbing from the water tank to the pump is protected from freezing with heat trace tape and insulation.

## PRESSURE GOVERNOR

The pressure governor is designed to maintain a selected water pump pressure or water pump engine speed setting. When the water pump engine is powered up, the water pump engine will remain at idle until the MODE switch is pressed to select the desired operating mode, RPM mode, or PRESSURE mode.

When the pressure governor is in RPM mode, MESSAGE CENTER will display THROTTLE and the green RPM LED will be illuminated. Water pump engine speed is controlled by the INCrease (INC) and DECrease (DEC) switches, MESSAGE CENTER will display INCREASE or DECREASE as appropriate when these switches are depressed. The water pump engine will maintain an RPM appropriate for the throttle signal being sent. If, while operating in RPM mode, the pressure increases more than 50 psi (345 kPa) from the pressure logged at the last switch pressed, the pressure governor will limit the pressure increase to no more than a 50 psi (345 kPa) difference. The pressure governor may reduce water pump engine RPM to ensure pressure difference. PSI LIMIT will be displayed in MESSAGE CENTER. The pressure governor will not attempt to regulate pressure in this mode, only limit the pressure difference to 50 psi (345 kPa) from the pressure present when the last switch was pressed.

When the pressure governor is operating in the PRESSURE mode, MESSAGE CENTER will display PRESSURE and the amber PRESSURE LED will illuminate. Water pump pressure is set by using the INCrease and DECrease switches. The pressure governor will attempt to maintain the last pressure achieved with these switches. MESSAGE CENTER will display INCREASE or DECREASE as appropriate. The pressure governor maintains water pump pressure by controlling water pump engine RPM in response to a signal from the pressure transducers. When controlling in this manner, MESSAGE CENTER will display CTRL DEC or CTRL INC.

Pressing PRESET switch in either mode will control the water pump engine to attain the preset RPM or water pump pressure programmed in the pressure governor memory. If there is more than 10 psi (69 kPa) pressure on the water pump, the RPM preset is disabled and MESSAGE CENTER will display DISABLED.

---

Whenever the transducer signal is below 0.3 VDC or above 4.8 VDC, a sensor fault will be logged and SENSOR will be displayed in MESSAGE CENTER. SENSOR will flash if the failure occurs while the pressure governor is operating in psi mode. Once a failure is detected, the pressure governor can no longer maintain a pressure setting. It will hold the current water pump engine RPM and only operate as a throttle. Once SENSOR is displayed in MESSAGE CENTER, SENSOR will not clear until power to the pressure governor is reset. It is extremely important that the cause for this message is investigated. The pressure governor cannot discharge pressure properly unless the SENSOR signal is reliable and correct.

If the INC switch is held, the pressure governor will not allow a change greater than 80 psi (552 kPa) without releasing the INC switch and pressing it again. This is only applicable when the discharge pressure is above 90 psi (621 kPa).

If the discharge pressure drops below 30 psi (207 kPa) for any reason, the water pump engine speed will not be increased. The pressure governor output voltage will reduce to the last known value where the pressure setpoint was obtained. MESSAGE CENTER will display INTAKE during this low pressure condition. If the pressure increases above 30 psi (207 kPa), OPERATOR will flash in MESSAGE CENTER and the pressure governor will not increase output unless the operator presses the INC or PRESET switches. If pressure above 30 psi (207 kPa) is not regained in 5 seconds, the pressure governor will return the water pump engine to idle and display LOSUPPLY. The operator must make certain that the water supply is adequate and then reinstate the pressure governor using the MODE, INC, and/or PRESET switches.

The pressure governor has a trim adjustment that can be set between 5% and 20% of maximum increase in a pressure recovery attempt. MESSAGE CENTER will flash OPERATOR when this limit is reached and the RPM will not increase further. The operator must take positive action to restore discharge pressure. If pressure is not restored within 4 seconds, the pressure governor will reduce output to the last known output where pressure was maintained. The operator must input a new setpoint with the INC, DEC, or PRESET switches. If the pressure rises above the original setpoint and the pressure governor controls a decrease in water pump engine speed, the pressure governor will return to normal operations and PSI MODE will be displayed in MESSAGE CENTER.

**END OF WORK PACKAGE**

## **CHAPTER 2**

### **OPERATOR INSTRUCTIONS**



**OPERATOR MAINTENANCE**

**DESCRIPTION AND USE OF OPERATOR'S CONTROLS AND INDICATORS**

**CONTROLS AND INDICATORS INTRODUCTION**

This section shows the location and describes the use of controls and indicators used to operate the M1142 firefighting systems. Refer to TM 9-2320-347-10 for all other controls and indicators.

Know location and proper use of every control and indicator before operating the vehicle. Use this section to learn about each control and indicator to be used. Separate illustrations with keys are provided for the following group of controls and indicators:

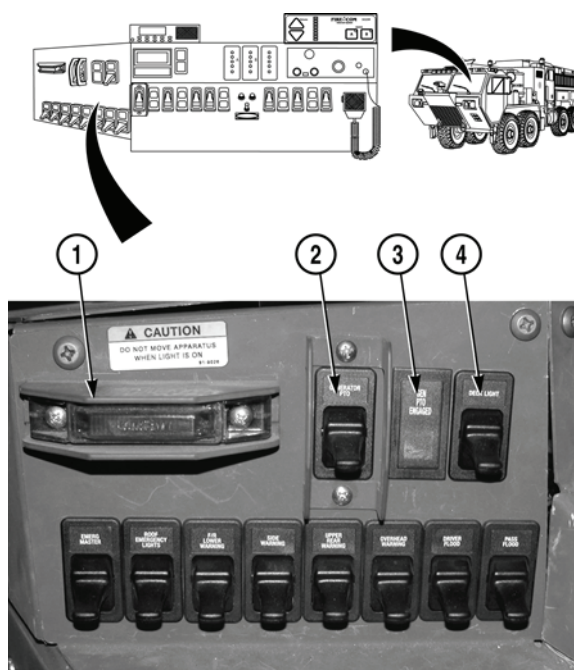

**Figure 1. Cab Instrument Panel - Upper Left.**

Key Fig. 1	Control or Indicator	Function
1	DO NOT MOVE APPARATUS WHEN LIGHT IS ON indicator	Indicator light illuminates whenever a compartment door is open or equipment (ladder) rack is down.
2	GENERATOR PTO Switch	Push up to engage generator PTO. Push down to disengage generator PTO.
3	GENERATOR PTO ENGAGED Indicator Light	Indicator light illuminates when generator PTO is engaged.
4	DECKLIGHT Switch	Push up to engage decklight. Push down to disengage decklight.

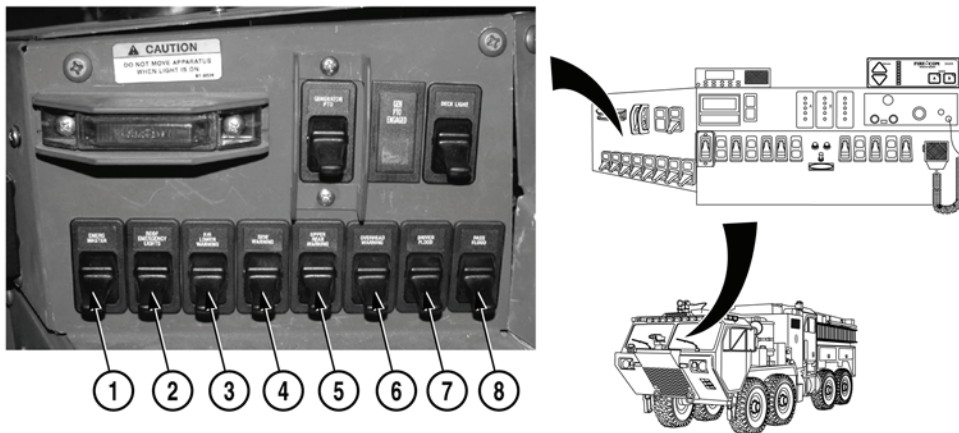

**Figure 2. Cab Instrument Panel - Lower Left.**

Key Fig. 2	Control or Indicator	Function
1	EMERG MASTER Light Switch	Push up to turn on all emergency warning lights. Push down to turn off all emergency warning lights. Operates all warning lights that are in on position.
2	ROOF EMERGENCY LIGHTS Switch	Push up to turn on roof emergency lights. Push down to turn off roof emergency lights.
3	F/R LOWER WARNING Light Switch	Push up to turn on front and rear lower warning lights. Push down to turn off front and rear lower warning lights.
4	SIDE WARNING Light Switch	Push up to turn on side warning lights. Push down to turn off side warning lights.
5	UPPER REAR WARNING Light Switch	Push up to turn on upper rear warning lights. Push down to turn off upper rear warning lights.
6	OVERHEAD WARNING Light Switch	Push up to turn on overhead warning lights. Push down to turn off overhead warning lights.
7	DRIVER FLOOD Light Switch	Push up to turn on driver flood light. Push down to turn off driver flood light. This light only operates with generator running.
8	PASS FLOOD Light Switch	Push up to turn on passenger flood light. Push down to turn off passenger flood light. This light only operates with generator running.



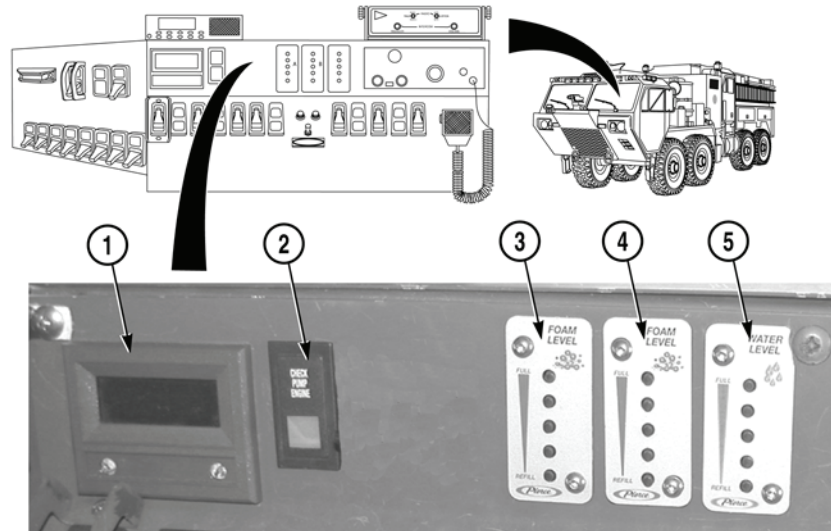

**Figure 3. Cab Instrument Panel - Upper Center.**

Key Fig. 3	Control or Indicator	Function
1	PUMP DISCHARGE Gauge	Monitors pump discharge pressure.
2	CHECK PUMP ENGINE Indicator Light	Illuminates when pump engine oil pressure too low, or water pump engine coolant temperature too high.
3	Class A FOAM LEVEL Gauge	Monitors the level of Class A foam agent in foam tank.
4	Class B FOAM LEVEL Gauge	Monitors the level of Class B foam agent in foam tank.
5	WATER LEVEL Gauge	Monitors level of water in water tank.

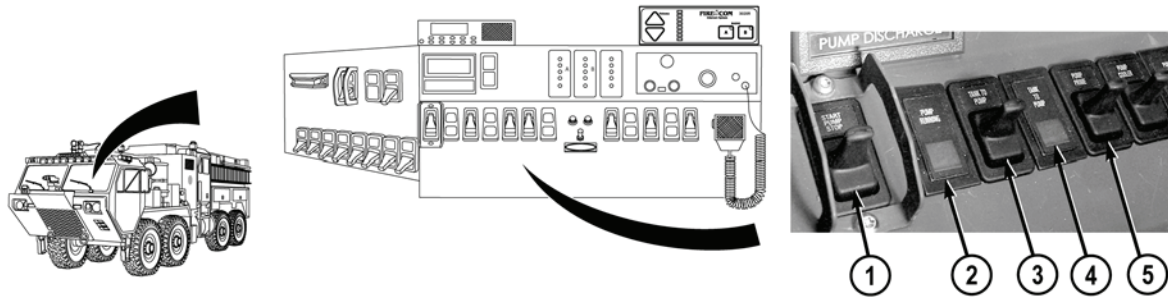

**Figure 4. Cab Instrument Panel - Lower Center (Sheet 1 of 2).**

Key Fig. 4	Control or Indicator	Function
1	START PUMP STOP Switch	Push up to start water pump engine. Push down to stop water pump engine.
2	PUMP RUNNING Indicator Light	PUMP RUNNING indicator light illuminates when water pump is running.
3	TANK TO PUMP Switch	Push up to open tank discharge (TANK TO PUMP) valve. Push down to close tank discharge (TANK TO PUMP) valve.
4	TANK TO PUMP Indicator Light	Illuminates when tank discharge (TANK TO PUMP) valve is open.
5	PUMP PRIME Switch	Push up to activate priming valve and operate electric primer pump. Release to close priming valve and stop electric primer pump.

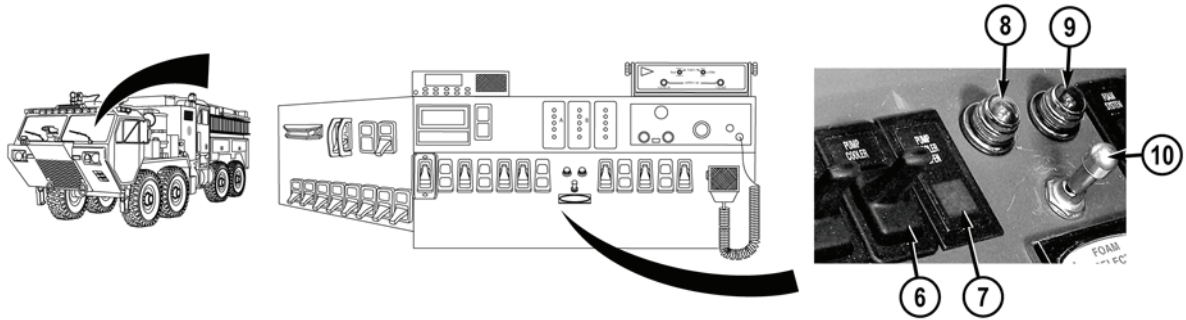

**Figure 4. Cab Instrument Panel - Lower Center (Sheet 2 of 2).**

Key Fig. 4	Control or Indicator	Function
6	PUMP COOLER Switch	Push up to open valve to dump water to ground. Push down to close valve. This helps keep water pump cool when water is not being discharged.
7	PUMP COOLER Indicator Light	Indicator light illuminates when pump cooler valve is open.
8	Class A Foam Indicator Light	Indicator light illuminates when Class A foam is selected.
9	Class B Foam Indicator Light	Indicator light illuminates when Class B foam is selected.
10	FOAM SELECT Switch	Push switch to left for Class A foam; push switch to right for Class B foam. Switch automatically goes to center position when released.

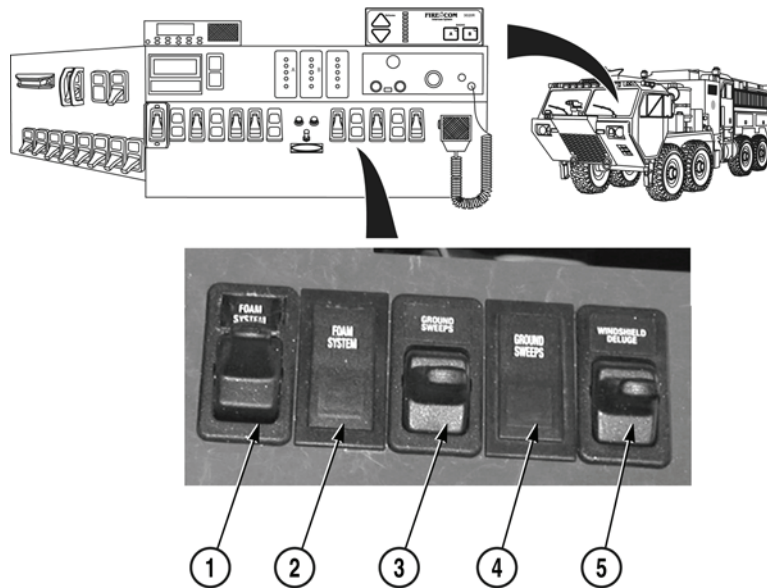

**Figure 5. Cab Instrument Panel - Lower Right.**

Key Fig. 5	Control or Indicator	Function
1	FOAM SYSTEM Switch	Push up to turn on foam system. Push down to turn off foam system.
2	FOAM SYSTEM Indicator Light	Illuminates when foam system is operational.
3	GROUND SWEEPS Switch	Push up to open valves and discharge water through ground sweeps. Push down to close valves.
4	GROUND SWEEPS Indicator Light	Indicator light illuminates when ground sweeps valve is open.
5	WINDSHIELD DELUGE Switch	Push up to open valve and discharge water to windshield. Push down to close windshield deluge valve.

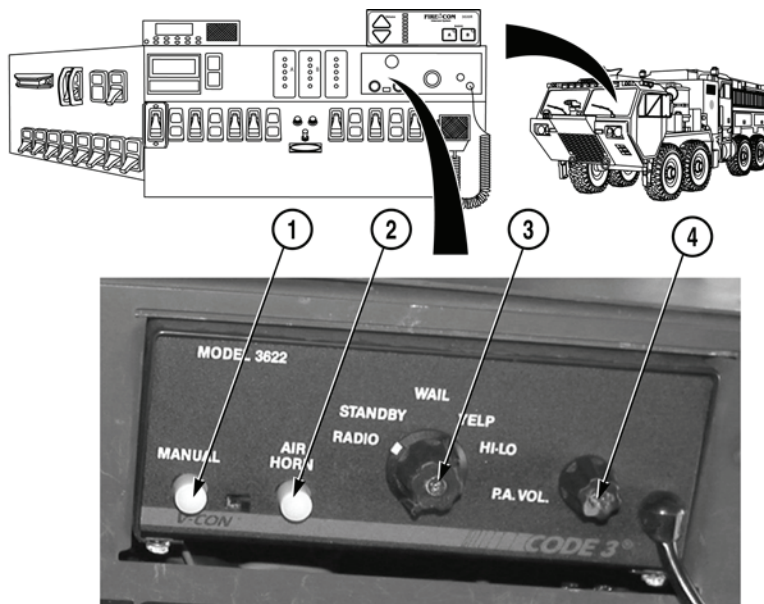
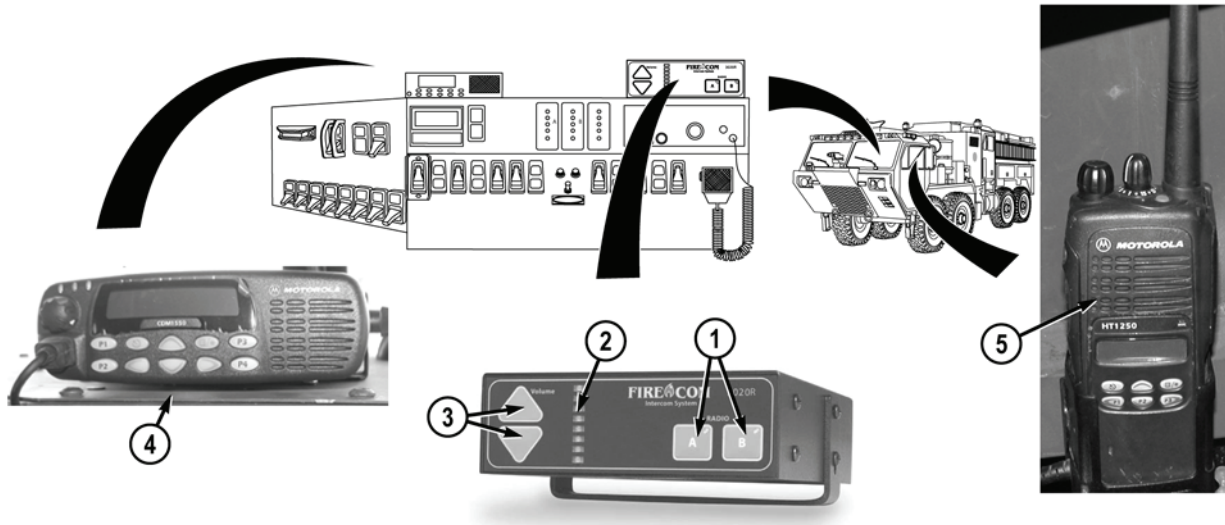

Figure 6. Cab Instrument Panel - Upper Right/Electronic Siren Controls.

Key Fig. 6	Control or Indicator	Function
1	MANUAL Operation Switch	<p><b>NOTE</b></p> <p>The HIT &amp; GO feature produces audio sounds for approximately 5 seconds.</p> <p>Push button switch has no effect when selector switch is in RADIO. Produces wail sound when selector switch is in STANDBY. Produces yelp sound when selector switch is in WAIL. Has no effect when the selector switch is in YELP. Produces yelp sound when selector switch is in HI-LO.</p>
2	AIR HORN Switch	Produces air horn sound in all selector switch positions except RADIO.
3	MODE Switch	Used to switch between modes of operation. Possible selections are PA, RADIO, STANDBY, WAIL, YELP, HI-LO, and PUSH-TO-TALK (PTT).
4	P.A. VOLUME Switch	Used to adjust level of P.A. audio.



**Figure 7. Cab Instrument Panel - Upper Right/Radio.**

Key Fig. 7	Control or Indicator	Function
1	Transmit Select/Receive Select	Used to select between RADIO A, RADIO B, or both.
2	LED Display	Shows volume level when sending or receiving communications.
3	Intercom Volume	Adjusts intercom volume level.
4	Mobile Radio	Base unit used to communicate with other radios.
5	Handheld Radio	Portable unit used to communicate with other radios.

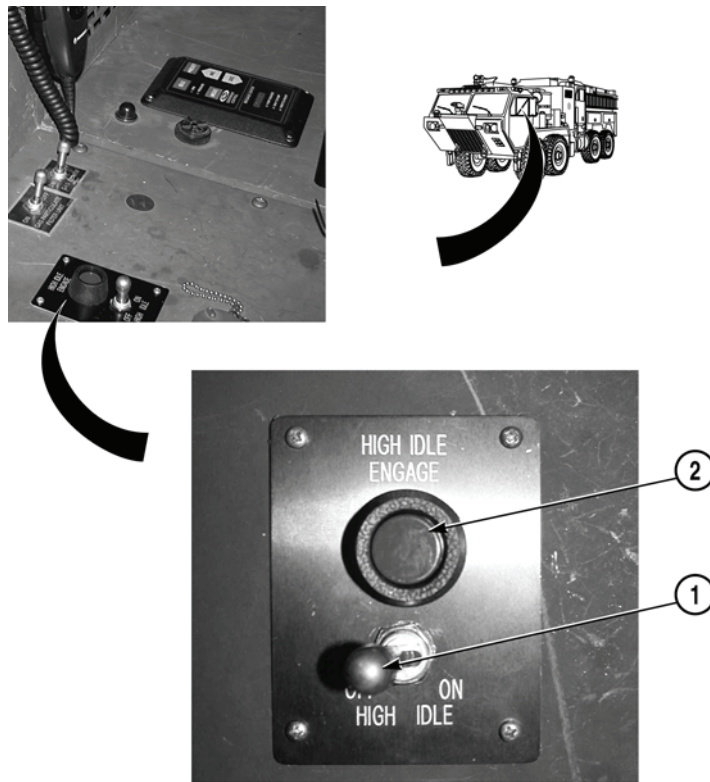

**Figure 8. Cab Instrument Panel - Center Console (Sheet 1 of 3).**

Key Fig. 8	Control or Indicator	Function
1	HIGH IDLE Switch	Used to bring the truck engine to 1000 RPMs in order for generator to run at peak performance.
2	HIGH IDLE ENGAGE Indicator Light	Illuminates when high idle switch is put to ON position.

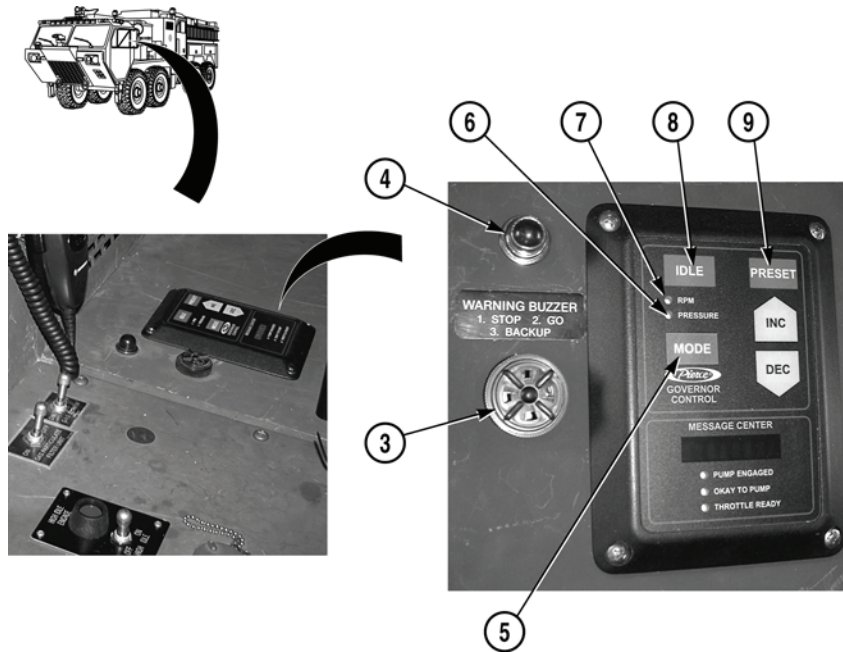

**Figure 8. Cab Instrument Panel - Center Console (Sheet 2 of 3).**

Key Fig. 8	Control or Indicator	Function
3	WARNING BUZZER	Provides audible warning to the driver from rear step buzzer. Buzzer sounds once to STOP, twice to GO, and three times to BACKUP.
4	Warning Indicator Light	Light illuminates once to tell the driver to stop, twice to go, and three times to back-up.
5	MODE Switch	Press to select operating mode.
6	PRESSURE LED	Illuminates when in PRESSURE mode.
7	RPM LED	Illuminates when in RPM mode.
8	IDLE Switch	Press to return water pump engine to idle.
9	PRESET Switch	Press after an operating mode has been chosen, to promptly bring engine or pump RPM to a preset pressure.



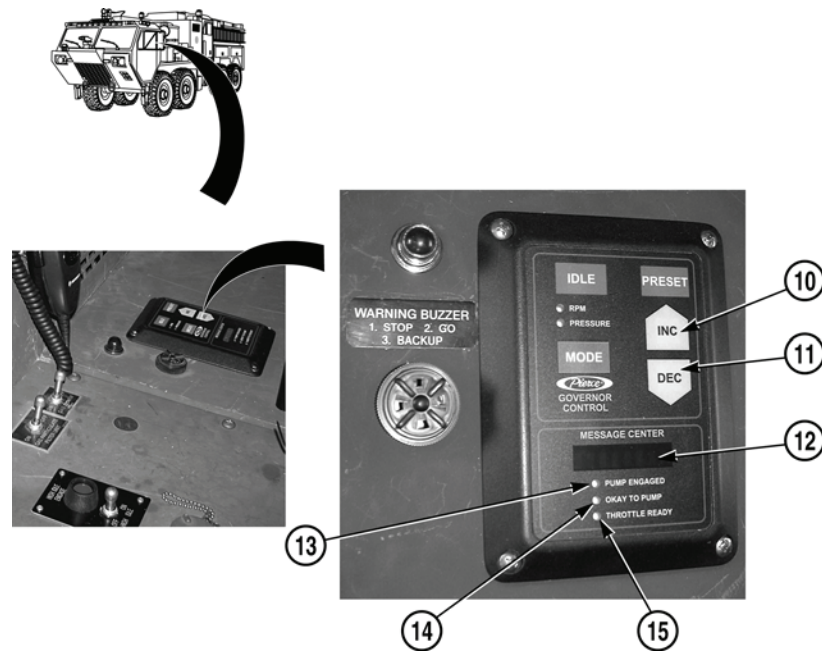

Figure 8. Cab Instrument Panel - Center Console (Sheet 3 of 3).

Key Fig. 8	Control or Indicator	Function
10	INC (increase) Switch	When INC switch is pressed, INCREASE is displayed in MESSAGE CENTER. Depressing INC switch increases water pump engine RPM. When INC switch is released, current pump engine RPM is maintained by pressure governor.
11	DEC (decrease) Switch	When DEC switch is pressed DECREASE is displayed in MESSAGE CENTER. Depressing DEC switch decreases water pump engine RPM. When DEC switch is released, current water pump engine RPM is maintained by pressure governor.
12	MESSAGE CENTER	Displays current information about pressure governor.
13	PUMP ENGAGED LED	Illuminates when water pump is engaged.
14	OKAY TO PUMP LED	Illuminates when it is ok to start pump operations.
15	THROTTLE READY LED	Illuminates when throttle is ready.

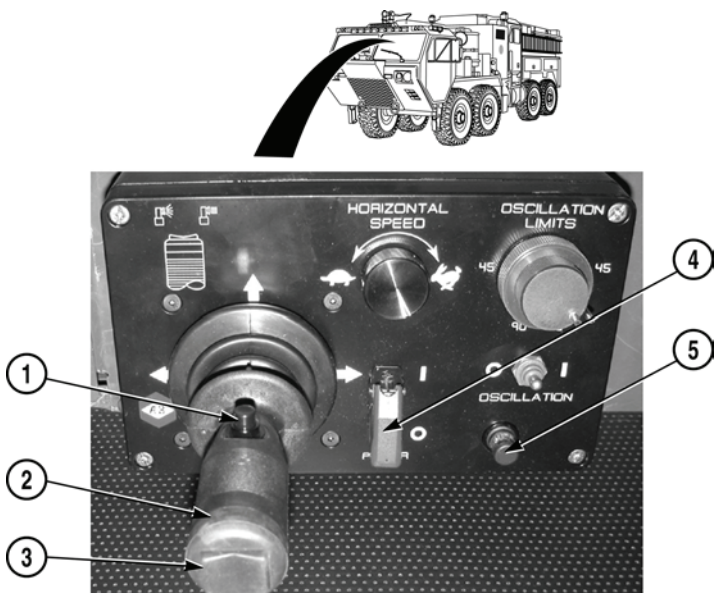

Figure 9. Bumper Turret Controls (Sheet 1 of 2).

Key Fig. 9	Control or Indicator	Function
1	Agent Discharge Button	Press to discharge agent; press a second time to interrupt discharge. This is a push on, push off type button.
2	Joystick Control Handle	Used for joystick control of bumper turret.
3	Pattern Control Button	Used to adjust shape of discharge spray pattern between stream and fully fog. Push button on left side for fog and right side for stream.
4	POWER Switch	Push to   position to turn on. Push to O position to turn off.
5	Panel Light	Light illuminates bumper turret controls.

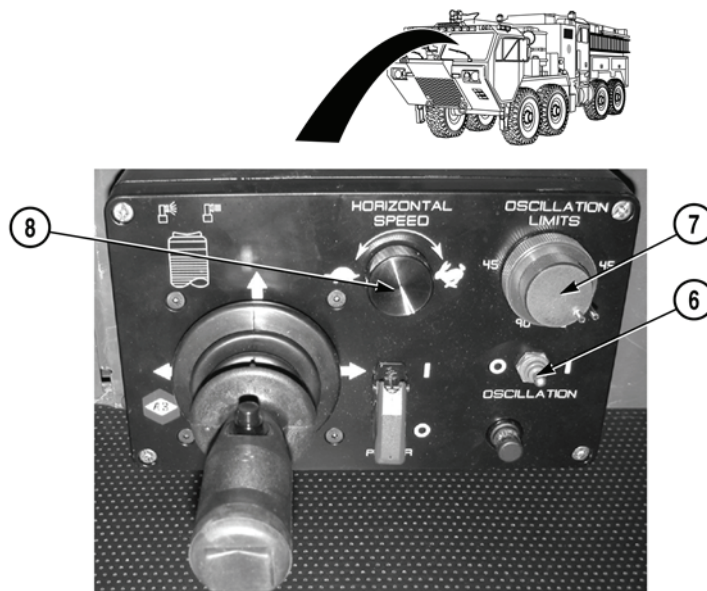
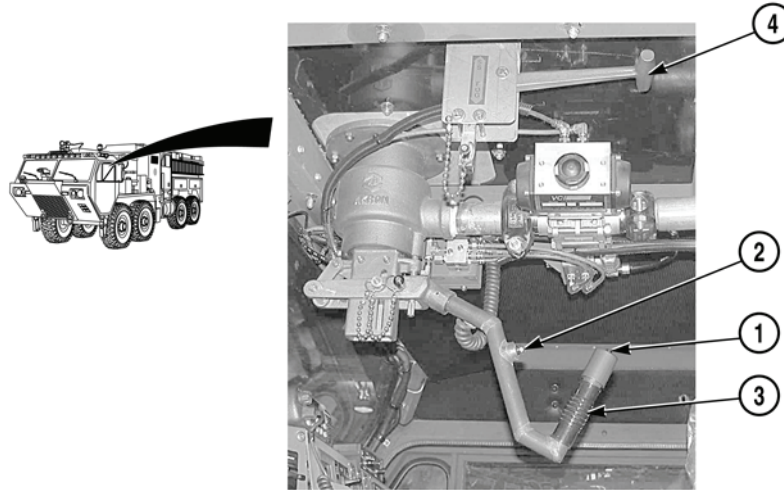

Figure 9. Bumper Turret Controls (Sheet 2 of 2).

Key Fig. 9	Control or Indicator	Function
6	OSCILLATION Switch	Used to activate and deactivate turret auto-oscillation mode. Joystick control handle can be used to elevate or depress bumper turret nozzle during auto-oscillation mode. Joystick control handle will override auto-oscillation mode back to joystick control mode if moved left or right during auto-oscillation mode. To reactivate auto-oscillation mode after joystick override, push oscillation toggle to   (on) position. The turret will always reactivate to the left.
7	OSCILLATION LIMITS Control Knob	Used to set left/right limits of auto-oscillation mode. Two oscillation limit control knobs are stacked together. Small knob on top controls right oscillation limit. Larger knob on bottom controls left limit angle. Pin on top of each knob is set point for oscillation limit control.
8	HORIZONTAL SPEED Control	Rotary adjustment to regulate rotation and sweep speed of bumper turret when in joystick control mode or auto-oscillation mode. Full slow position will not stop turret.



**Figure 10. Roof Turret Controls.**

Key Fig. 10	Control or Indicator	Function
1	Agent Discharge Button	Push to discharge agent; press a second time to interrupt discharge. This is a push on, push off type button.
2	Agent Discharge Indicator Light	Indicator light illuminates when agent is being discharged.
3	Control Handle	Used for control of roof turret.
4	Pattern Control Handle	Used to adjust shape of discharge spray pattern between stream and fully fog. Push button on left side for fog and right side for stream.

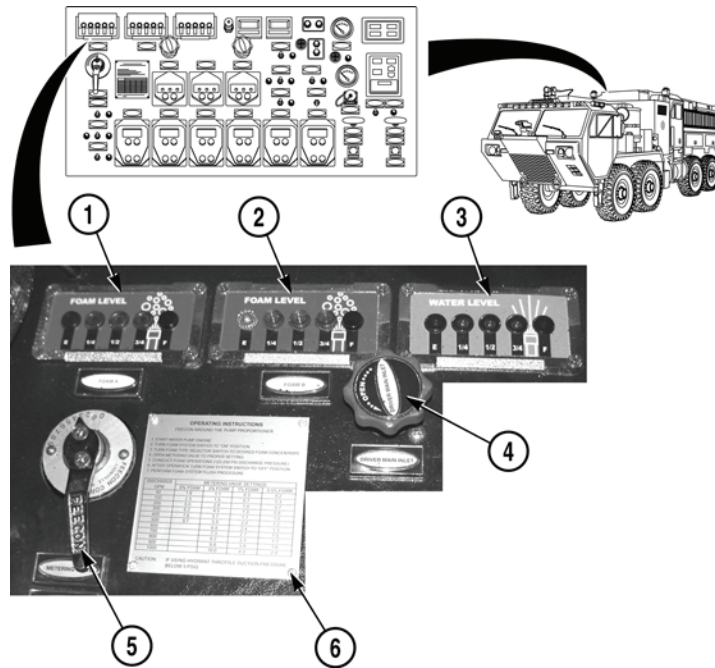

Figure 11. Pump Operator's Panel - Upper Left.

Key Fig. 11	Control or Indicator	Function
1	FOAM A LEVEL Gauge	Monitors level of the class A foam agent in foam tank.
2	FOAM B LEVEL Gauge	Monitors level of the class B foam agent in foam tank.
3	WATER LEVEL Gauge	Monitors level of water in on-board water tank.
4	DRIVER MAIN INLET BLEEDER Valve	Turn counterclockwise to open bleeder valve. Turn clockwise to close bleeder valve.
5	Foam METERING VALVE	Move foam metering valve handle clockwise to lower foam percentage rate; move metering valve handle counterclockwise to raise foam percentage rate.
6	FOAM CHART	Gives percentage to foam metering valve settings.

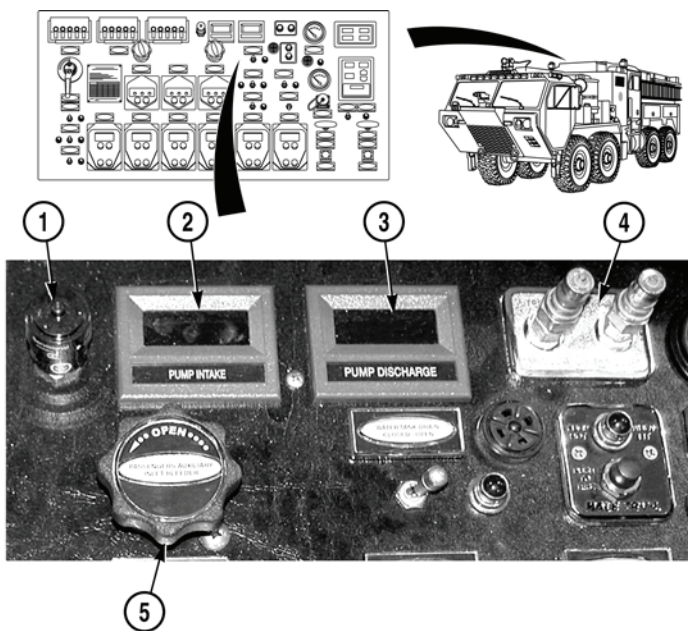

Figure 12. Pump Operator's Panel - Upper Center (Sheet 1 of 2).

Key Fig. 12	Control or Indicator	Function
1	Air Flow Restrictor Indicator	Shows condition of water pump engine air cleaner filter. Indicator window shows red when filter becomes clogged.
2	PUMP INTAKE Gauge	Indicates the vacuum and pressure present in the intake side of the pump system in psi.
3	PUMP DISCHARGE Gauge	Indicates the pressure present in the discharge side of pump system in psi.
4	Test Gauge Panel	Connections used for testing the accuracy of the water pump performance.
5	PASSENGER AUXILIARY INLET BLEEDER Valve	Turn counterclockwise to open bleeder valve. Turn clockwise to close bleeder valve.

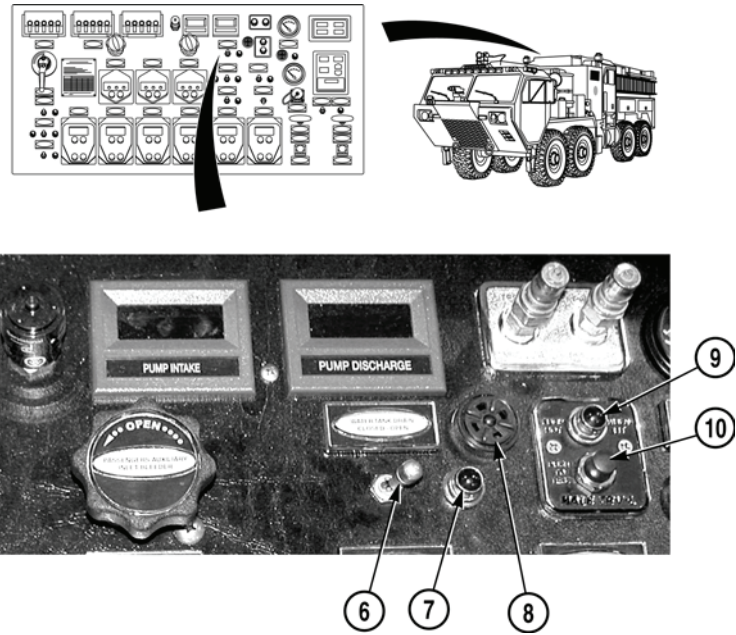

Figure 12. Pump Operator's Panel - Upper Center (Sheet 2 of 2).

Key Fig. 12	Control or Indicator	Function
6	WATER TANK DRAIN Switch	Push switch to right to open tank drain. Push switch to left to close tank drain.
7	TANK DRAIN Indicator Light	Illuminates when tank drain is open.
8	Warning Buzzer	Provides audible warning in the event of a water pump overheat condition.
9	Thermal Relief Indicator Light	Illuminates in the event of a water pump overheat condition.
10	Warning Buzzer and Thermal Relief Indicator Light Test Button	When depressed, checks operation of both warning buzzer and thermal relief indicator light.

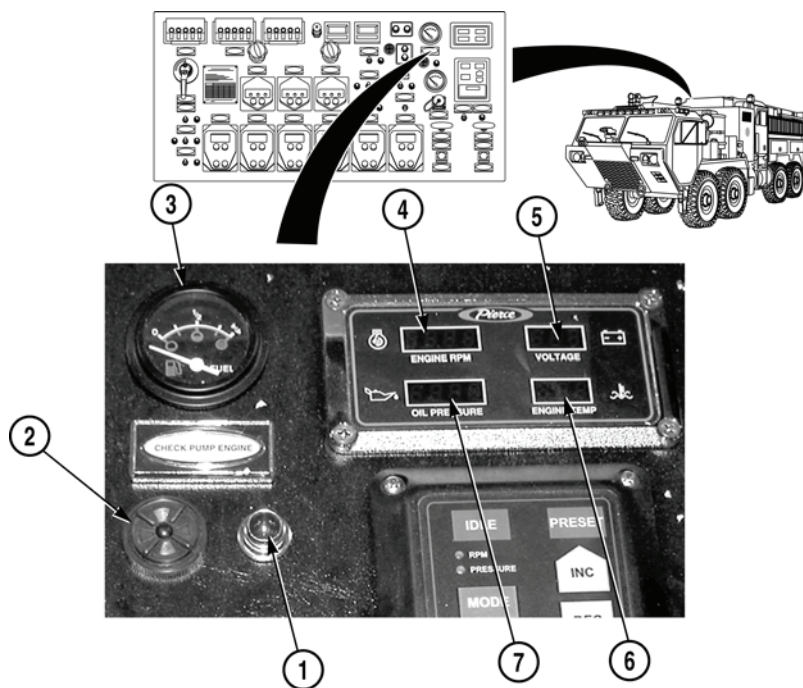

Figure 13. Pump Operator's Panel - Upper Right (Sheet 1 of 3).

Key Fig. 13	Control or Indicator	Function
1	CHECK PUMP ENGINE Indicator Light	Illuminates if water pump engine oil pressure is too low or water pump engine coolant temperature is too high.
2	Warning Buzzer	Provides audible warning if water pump engine oil pressure is too low or water pump engine coolant temperature is too high.
3	FUEL LEVEL Gauge	Monitors fuel level in vehicle fuel tank. Only operates when chassis engine is on.
4	ENGINE RPM Tachometer	Monitors water pump engine speed in RPM.
5	VOLTAGE Battery Gauge	Monitors voltage level of vehicle chassis electrical system.
6	ENGINE TEMP Gauge	Monitors water pump engine temperature.
7	OIL PRESSURE Gauge	Monitors water pump engine oil pressure in psi (kPa).



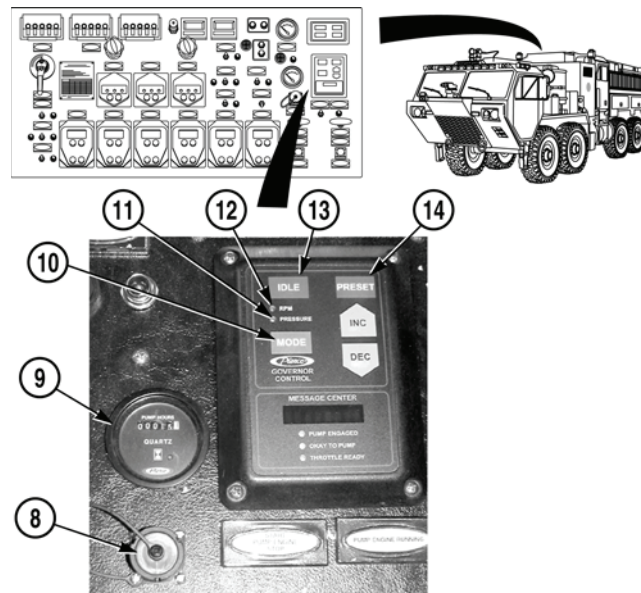

Figure 13. Pump Operator's Panel - Upper Right (Sheet 2 of 3).

Key Fig. 13	Control or Indicator	Function
8	PUMP ENGINE DIAGNOSTICS Plug	Plug for connecting test equipment for diagnosing problems with water pump engine.
9	Hourmeter	Records operating hours of water pump engine.
10	MODE Switch	Press to select operating mode.
11	PRESSURE LED	Illuminates when in PRESSURE mode.
12	RPM LED	Illuminates when in RPM mode.
13	IDLE Switch	Press to return water pump engine to idle.
14	PRESET Switch	Press after an operating mode has been chosen, to promptly bring engine or pump RPM to a preset pressure.

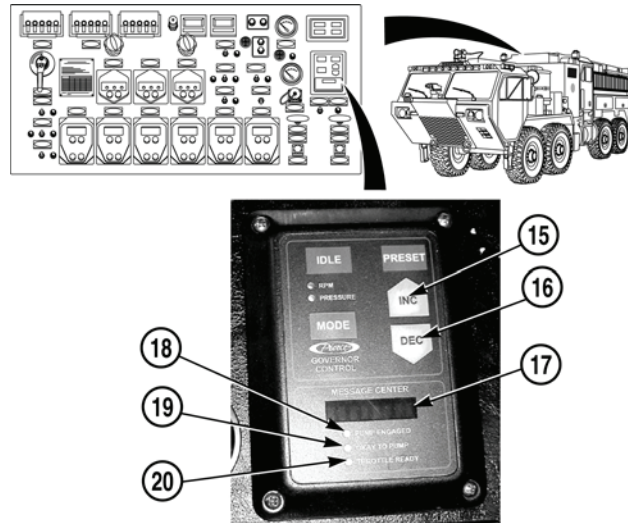
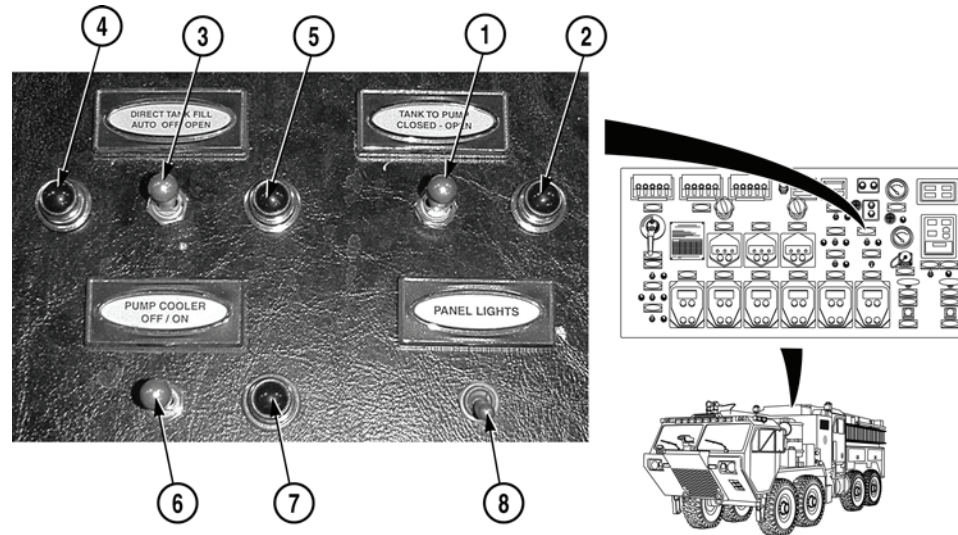

Figure 13. Pump Operator's Panel - Upper Right (Sheet 3 of 3).

Key Fig. 13	Control or Indicator	Function
15	Increase (INC) Switch	When INC switch is pressed, INCREASE is displayed in MESSAGE CENTER. Depressing INC switch increases water pump engine RPM. When INC switch is released, current pump engine RPM are maintained by pressure governor.
16	Decrease (DEC) Switch	When DEC switch is pressed DECREASE is displayed in MESSAGE CENTER. Depressing DEC switch decreases water pump engine RPM. When DEC switch is released, current water pump engine RPM are maintained by pressure governor.
17	MESSAGE CENTER	Displays current information about pressure governor.
18	PUMP ENGAGED LED	Illuminates when water pump is engaged.
19	OKAY TO PUMP LED	Illuminates when it is ok to start pump operations.
20	THROTTLE READY LED	Illuminates when throttle is ready.



**Figure 14. Pump Operator's Panel - Center Right.**

Key Fig. 14	Control or Indicator	Function
1	TANK TO PUMP Switch	Lift and push switch to right to open TANK TO PUMP valve; lift and push switch to left to close TANK TO PUMP valve.
2	TANK TO PUMP Indicator Light	Illuminates when tank to pump valve is open.
3	DIRECT TANK FILL Switch	Lift and push switch to left to turn DIRECT TANK FILL to AUTO. Lift and push switch to right to turn DIRECT TANK FILL to OPEN. When switch is in center position DIRECT TANK FILL is OFF.
4	DIRECT TANK FILL AUTO Indicator Light	Illuminates when DIRECT TANK FILL switch is in AUTO position.
5	DIRECT TANK FILL OPEN Indicator Light	Illuminates when DIRECT TANK FILL switch is in ON position.
6	PUMP COOLER Switch	Lift and push switch to right to open valve to dump water to ground. Lift and push switch left to close valve. This helps keep water pump cool when water is not being discharged.
7	PUMP COOLER Indicator Light	Illuminates when PUMP COOLER valve is open.
8	PANEL LIGHTS Switch	Illuminates pump control panel when switch is in ON position. Push up to activate panel lights. Down for off.

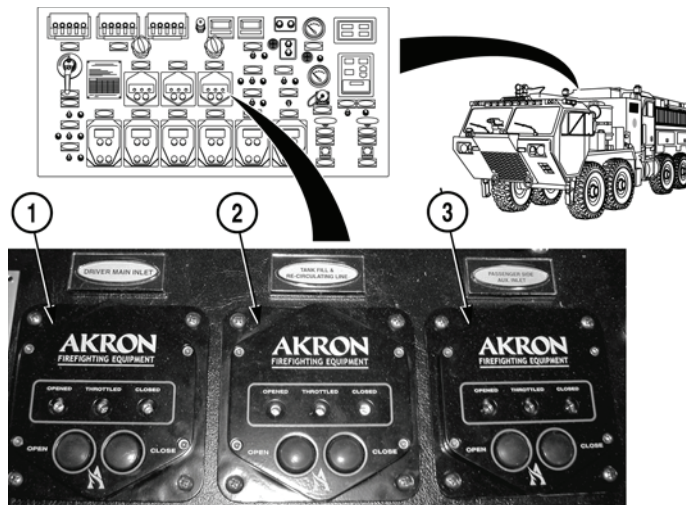

Figure 15. Pump Operator's Panel - Center.

Key Fig. 15	Control or Indicator	Function
1	DRIVER MAIN INLET Electric Valve Control	Used to operate driver side main inlet. To open valve, push and hold OPEN valve control button until valve attains desired position. To close valve, push and hold CLOSE valve control button until valve attains desired position. A multi-colored display indicates relative position of valve; fully open (green), throttling position (yellow), and fully closed (red).
2	TANK FILL & RE-CIRCULATING LINE Electric Valve Control	Used to operate valve that controls flow of water from inlets to on-board water tank. To open valve, push and hold OPEN valve control button until valve attains desired position. To close valve, push and hold CLOSE valve control button until valve attains desired position. A multi-colored display indicates relative position of valve; fully open (green), throttling position (yellow), and fully closed (red).
3	PASSENGER SIDE AUX. INLET Electric Valve Control	Used to operate passenger side aux. inlet valve. To open valve, push and hold OPEN valve control button until valve attains desired position. To close valve, push and hold CLOSE valve control button until valve attains desired position. A multi-colored display indicates relative position of valve; fully open (green), throttling position (yellow), and fully closed (red).

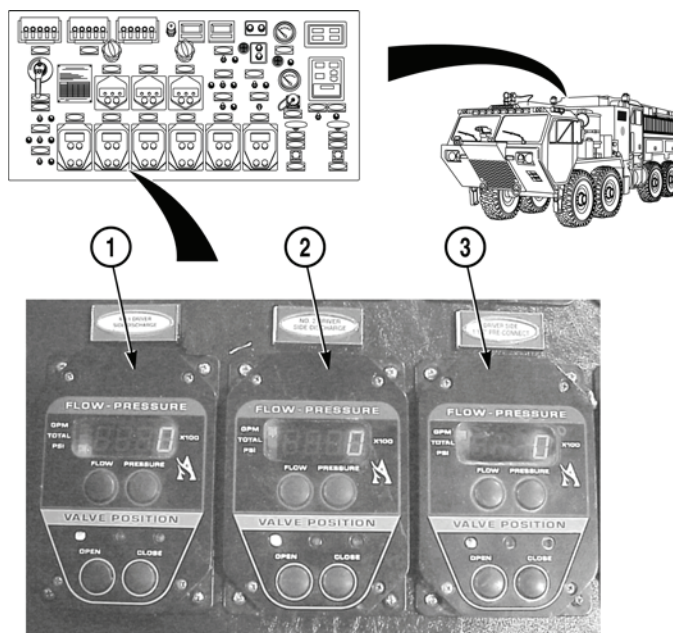

Figure 16. Pump Operator's Panel - Middle/Lower Left (Sheet 1 of 2).

Key Fig. 16	Control or Indicator	Function
1	NO. 1 DRIVER SIDE DISCHARGE Electric Valve Control/Meter	Provides control of No.1 DRIVER SIDE DISCHARGE. Two-button operation to read pressure, flow, and total flow. LED readout indicates GPM, total gallons flowed, and psi. Two-button, open and close valve position capability with red (closed), yellow (throttled), and green (open) LED valve position indicator lights.
2	NO. 2 DRIVER SIDE DISCHARGE Electric Valve Control/Meter	Provides control of No. 2 DRIVER SIDE DISCHARGE. Two-button operation to read pressure, flow, and total flow. LED readout indicates GPM, total gallons flowed, and psi. Two-button, open and close valve position capability with red (closed), yellow (throttled), and green (open) LED valve position indicator lights.
3	DRIVER PRE-CONNECT A Electric Valve Control/Meter	Provides control of DRIVER PRE-CONNECT A. Two-button operation to read pressure, flow, and total flow. LED readout indicates GPM, total gallons flowed, and psi. Two-button, open and close valve position capability with red (closed), yellow (throttled), and green (open) LED valve position indicator lights.

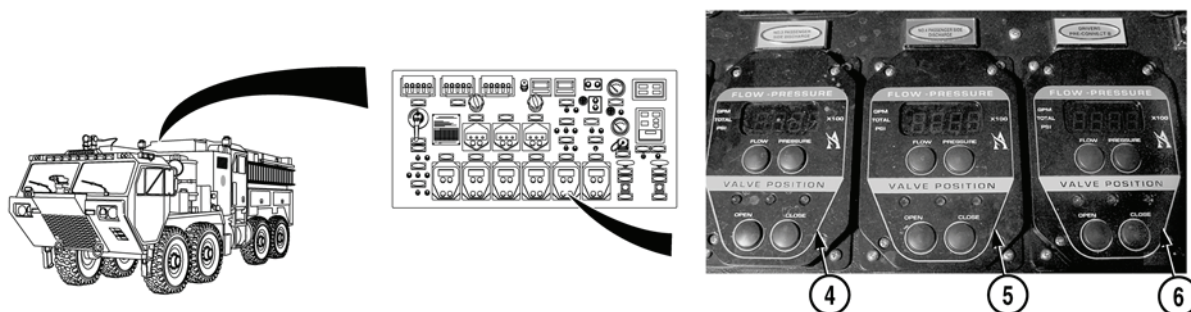

Figure 16. Pump Operator's Panel - Middle/Lower Left (Sheet 2 of 2).

Key Fig. 16	Control or Indicator	Function
4	NO. 3 PASSENGER SIDE DISCHARGE Electric Valve Control/Meter	Provides control of No. 3 PASSENGER SIDE DISCHARGE. Two-button operation to read pressure, flow, and total flow. LED readout indicates GPM, total gallons flowed, and psi. Two-button, open and close valve position capability with red (closed), yellow (throttled), and green (open) LED valve position indicator lights.
5	NO. 4 PASSENGER SIDE DISCHARGE Electric Valve Control/Meter	Provides control of No. 4 PASSENGER SIDE DISCHARGE. Two-button operation to read pressure, flow, and total flow. LED readout indicates GPM, total gallons flowed, and psi. Two-button, open and close valve position capability with red (closed), yellow (throttled), and green (open) LED valve position indicator lights.
6	DRIVERS PRE-CONNECT B Electric Valve Control/Meter	Provides control of DRIVER SIDE PRE-CONNECT B. Two-button operation to read pressure, flow, and total flow. LED readout indicates GPM, total gallons flowed, and psi. Two-button, open and close valve position capability with red (closed), yellow (throttled), and green (open) LED valve position indicator lights.

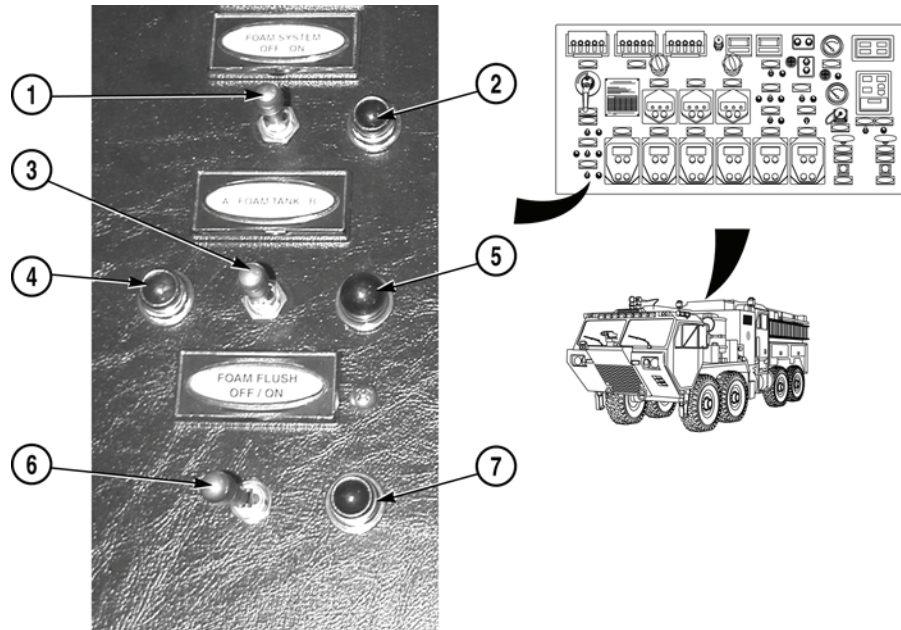

Figure 17. Pump Operator's Panel - Lower Left.

Key Fig. 17	Control or Indicator	Function
1	FOAM SYSTEM Switch	Lift and push switch right to turn on FOAM SYSTEM. Push switch left to turn off FOAM SYSTEM.
2	FOAM SYSTEM Indicator Light	Illuminates when foam system is operational.
3	FOAM TANK Selector Switch	Lift and push switch left for class A foam; push switch to right for class B foam. Switch automatically goes to center position when released.
4	CLASS A FOAM Indicator Light	Illuminates when class A foam is selected.
5	CLASS B FOAM Indicator Light	Illuminates when class B foam is selected.
6	FOAM FLUSH Switch	Lift and push switch to right to turn on FOAM FLUSH. Push switch to left to turn off FOAM FLUSH.
7	FOAM FLUSH Indicator Light	Illuminates when foam flush in ON position.

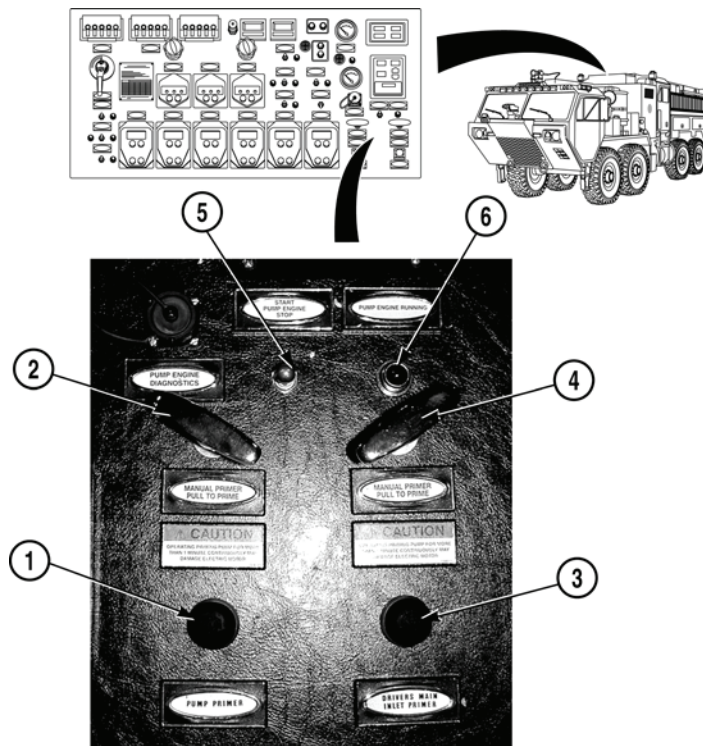
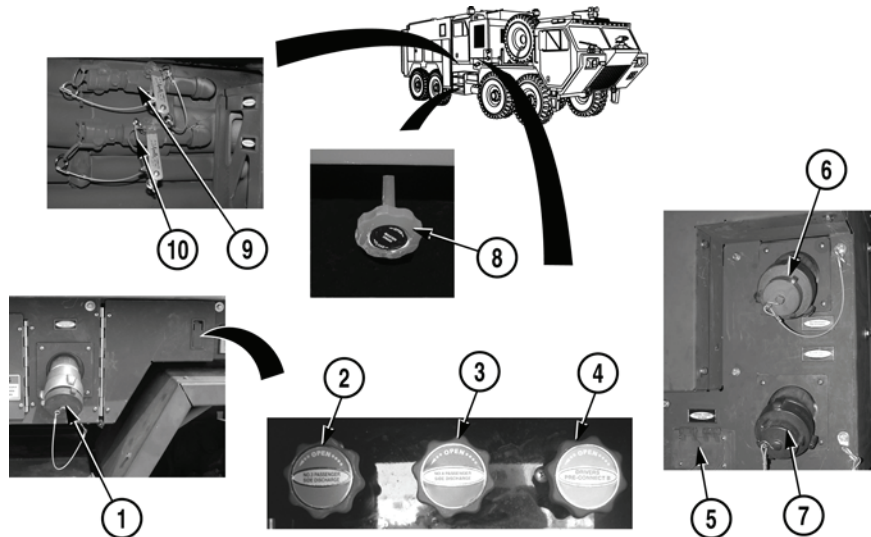

Figure 18. Pump Operator's Panel - Lower Right.

Key Fig. 18	Control or Indicator	Function
1	PUMP PRIMER Switch	Press to open pump primer valve and operate electric primer pump.
2	Pump MANUAL PRIMER Control	Used to bypass electric control circuit for pump primer valve. Pull handle to activate (open) pump primer valve.
3	DRIVER MAIN INLET PRIMER Switch	Press to open driver main inlet primer valve and operate electric primer pump.
4	Driver main inlet MANUAL PRIMER Control	Used to bypass electric control circuit for driver main inlet manual valve. Pull handle to activate (open) driver main inlet primer valve.
5	START PUMP ENGINE STOP Switch	Push switch up to start water pump engine; push switch down to stop water pump engine.
6	PUMP ENGINE RUNNING Indicator Light	Illuminates when water pump engine is running.





**Figure 19. Passenger Side of Pump House.**

Key Fig. 19	Control or Indicator	Function
1	PASSENGER SIDE AUX. INLET	Used to pump water from hydrant or from a positive water source.
2	NO. 3 PASSENGER SIDE DISCHARGE Drain Valve	Opens and closes discharge drain valve for the No. 3 PASSENGER SIDE DISCHARGE plumbing.
3	NO. 4 PASSENGER SIDE DISCHARGE Drain Valve	Opens and closes discharge drain valve for the No. 4 PASSENGER SIDE DISCHARGE plumbing.
4	DRIVER PRE-CONNECT B Drain Valve	Opens and closes discharge drain valve for the DRIVER PRE-CONNECT B discharge plumbing.
5	120 VAC, 15 AMP, 60 Hz Receptacle	Provides power for lights and other accessories.
6	NO. 3 PASSENGER SIDE DISCHARGE	Discharge connection for use with 3 in. (7.6 cm) hoses.
7	NO. 4 PASSENGER SIDE DISCHARGE	Discharge connection for use with 3 in. (7.6 cm) hoses.
8	MASTER DRAIN Valve	Opens and closes master drain valve.
9	A FOAM TANK DRAIN Valve	Used to drain foam agent from foam tank A.
10	B FOAM TANK DRAIN Valve	Used to drain foam agent from foam tank B.

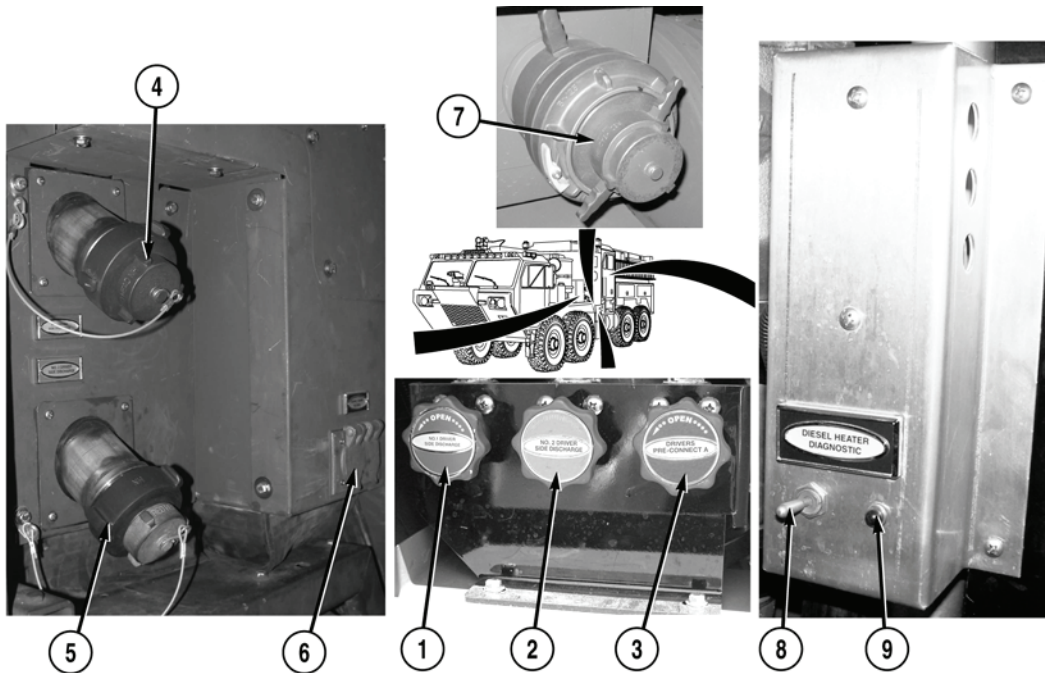

Figure 20. Driver Side of Pump House.

Key Fig. 20	Control or Indicator	Function
1	NO. 1 DRIVER SIDE DISCHARGE Drain Valve	Opens and closes discharge drain valve for the No. 1 DRIVER SIDE DISCHARGE plumbing.
2	NO. 2 DRIVER SIDE DISCHARGE Drain Valve	Opens and closes discharge drain valve for the No. 2 DRIVER SIDE DISCHARGE plumbing.
3	DRIVER PRE-CONNECT A Drain Valve	Opens and closes discharge drain valve for the DRIVER PRE-CONNECT A discharge plumbing.
4	NO. 1 DRIVER SIDE DISCHARGE	Discharge connection for use with 3 in. (7.6 cm) hose.
5	NO. 2 DRIVER SIDE DISCHARGE	Discharge connection for use with 3 in (7.6 cm) hose.
6	120 VAC, 15 AMP, 60 Hz Receptacle	Provides power for lights and other accessories.
7	Driver Side Main Inlet	Used to fill water tank or to pump water directly to water pump.
8	DIESEL HEATER Diagnostic Switch	Turn switch to ON position to get a diagnostic flash code.
9	DIESEL HEATER Diagnostics Indicator Light	Illuminates with a diagnostic flash code.

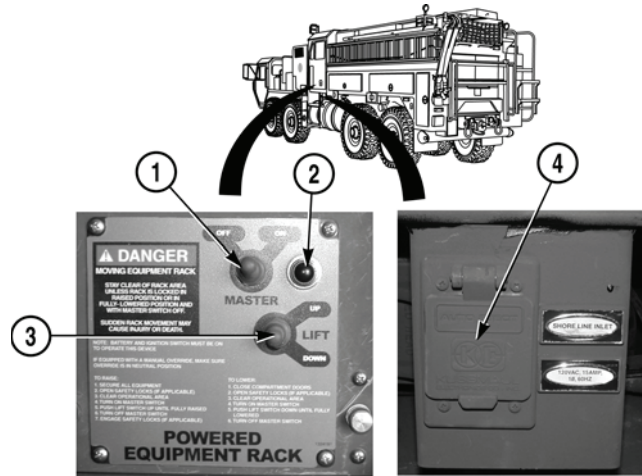
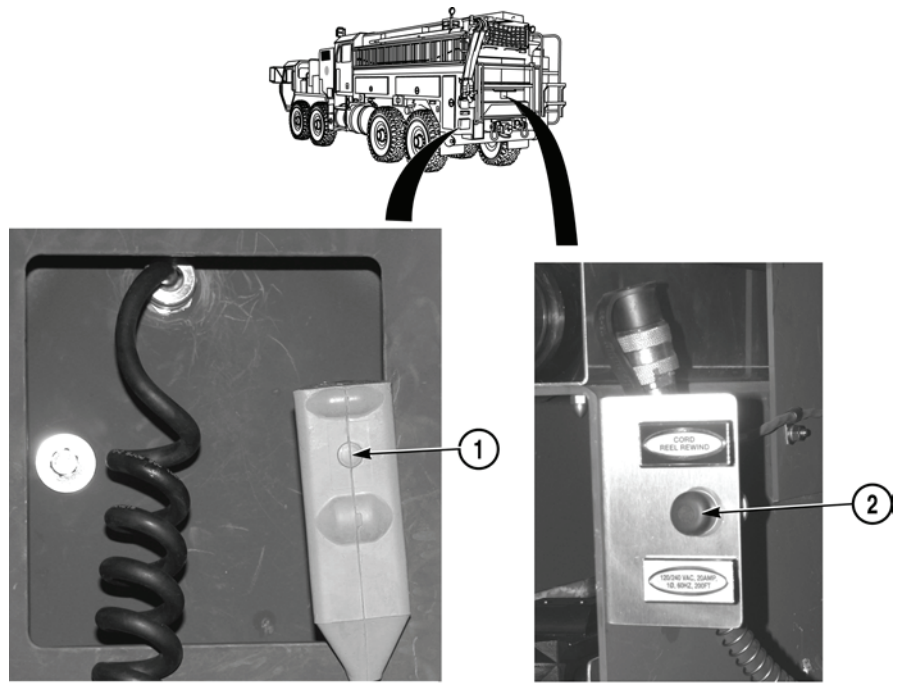

Figure 21. Equipment (Ladder) Rack Control.

Key Fig. 21	Control or Indicator	Function
1	MASTER Switch	Push switch to right to turn on power to equipment (ladder) rack. Push switch to left to turn off power to equipment (ladder) rack.
2	Master Switch Indicator Light	Illuminates when MASTER switch is in ON position.
3	LIFT Switch	Push up and hold to raise equipment (ladder) rack. Push down and hold to lower equipment (ladder) rack.
4	Auto Eject SHORELINE INLET	Used to maintain electrical charge for the chassis battery system and run air compressor to keep chassis air system charged when vehicle is not running. Also supplies power to reciprocating saw battery charger receptacle.



**Figure 22. Rear Step Buzzer Control and Cord Reel Rewind.**

Key Fig. 22	Control or Indicator	Function
1	Rear Step WARNING BUZZER Control	Push once to tell driver to stop, twice to go, and three times to back up.
2	CORD REEL REWIND Button	Push and hold button to rewind electrical cord.

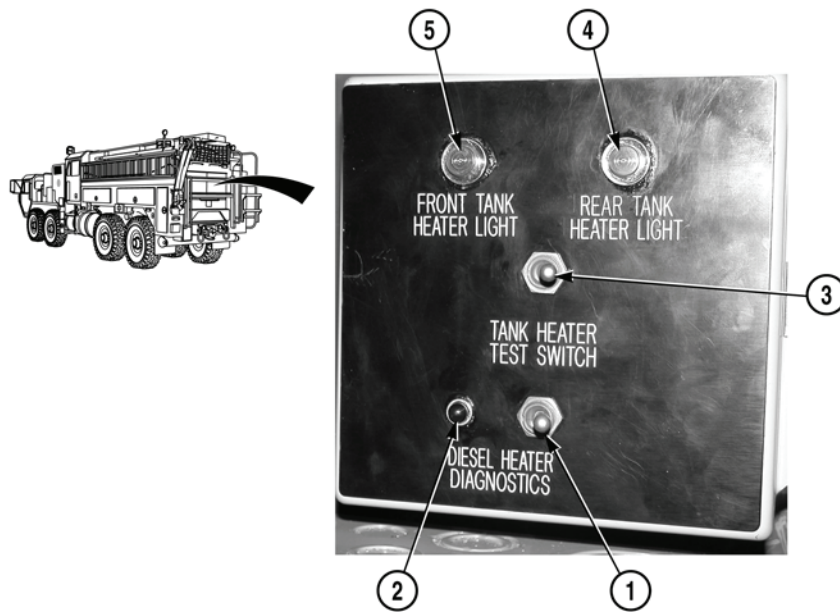

**Figure 23. Rear Compartment Test Switch Panel.**

Key Fig. 23	Control or Indicator	Function
1	DIESEL HEATER DIAGNOSTICS Switch	Push and hold 1/2 to 5 seconds to get a diagnostic flash code.
2	DIESEL HEATER DIAGNOSTICS Indicator Light	Illuminates with a diagnostic flash code.
3	TANK HEATER TEST SWITCH	Push and hold to check that tank heaters are working properly.
4	REAR TANK HEATER Indicator Light	Illuminates when rear tank heater is working properly.
5	FRONT TANK HEATER Indicator Light	Illuminates when front tank heater is working properly.

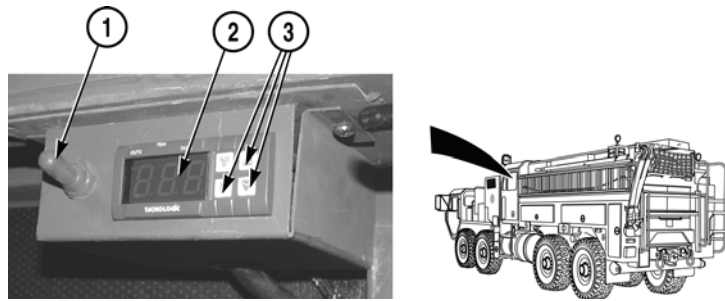

**Figure 24. Crew Cab Heater/Air Conditioner.**

Key Fig. 24	Control or Indicator	Function
1	Power ON/OFF Switch	Push down to turn on. Push down to turn off.
2	Temperature LED	Displays current information about present temperature.
3	Programing Buttons	Push up and down to set temperature.

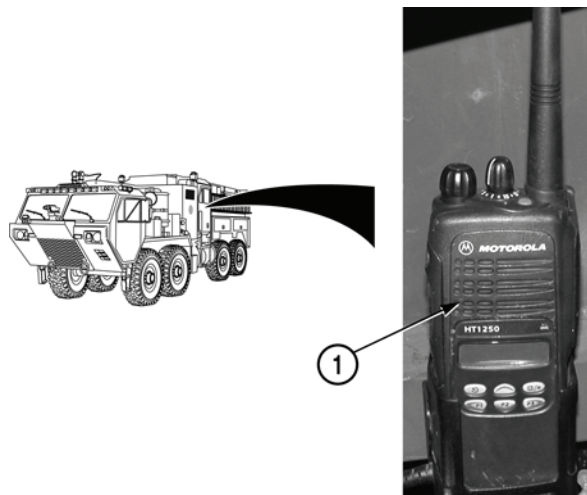

**Figure 25. Motorola Handheld Radio.**

Key Fig. 25	Control or Indicator	Function
1	Motorola Handheld Radio	Portable unit used to communicate with other radios.

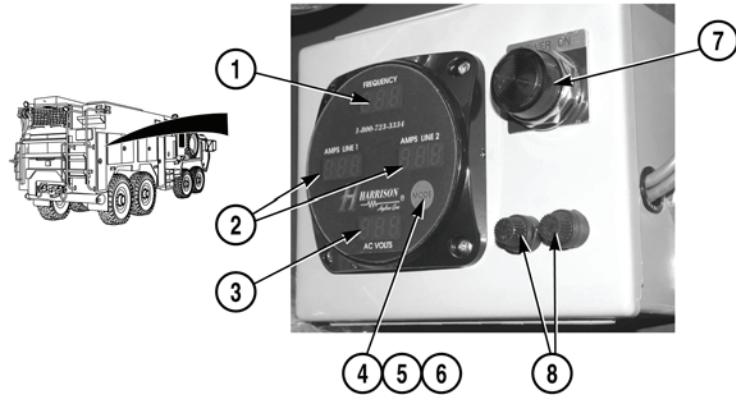

**Figure 26. Hydraulic Generator Display.**

Key Fig. 26	Control or Indicator	Function
1	FREQUENCY LED Display	Displays generator output frequency in Hz. Range: 0 to 99.9 Hz in one-tenth Hz increments.
2	AMPS LINE 1 and AMPS LINE 2 LED Display	Displays amperage for each of two generator output lines. Range: 0 to 150 in one-ampere increments.
3	AC VOLTS LED Display	Displays generator output voltage. Range: 0 to 300 VAC in one-volt increments.
4	MODE Button	Allows user to switch sequentially through STANDARD display mode, OPERATIONAL HOURS display mode and ENGINE OIL TEMPERATURE display mode.
5	OPERATIONAL HOURS Display Mode	Displays "HR" in the "FREQUENCY" LED panel and total generator operating hours in the "AMPS LINE 1" and "AMPS LINE 2" LED panels. Range: 0 to 99999.9 hours in one-tenth hour increments.
6	ENGINE OIL TEMPERATURE Display Mode	Displays "OIL" in the "FREQUENCY" LED panel and engine oil temperature in the "AMPS LINE 1" LED panel. The "AMPS LINE 2" LED panel displays "°F." Range: 0 to 230°F in one-degree increments.
7	POWER ON Light	Illuminates when generator is engaged.
8	Fuses	Protect against circuit overload by interrupting current flow if draw is above the circuit limit.

**END OF WORK PACKAGE**





---

**OPERATOR MAINTENANCE**  
**PREPARE TO OPERATE VEHICLE**

---

Refer to TM 9-2320-347-10 for procedure on preparing to operate vehicle.

**END OF WORK PACKAGE**



---

**OPERATOR MAINTENANCE**  
**PREPARATION FOR OPERATION-OPERATIONAL MODES**

---

**NOTE**

A complete TFFT crew is required to perform firefighting operations.

1. Ensure battery switch is in the ON position (TM 9-2320-347-10).
2. Ensure instrument control panel is in standby mode (WP 0032).
3. Ensure all tanks are full per mission requirement (WP 0020) and (WP 0031).
4. Ensure all personnel are familiarized with department procedures for setting wheel chocks (TM 9-2320-347-10).

**END OF WORK PACKAGE**



---

**OPERATOR MAINTENANCE**  
**BATTERIES CONNECT/DISCONNECT**

---

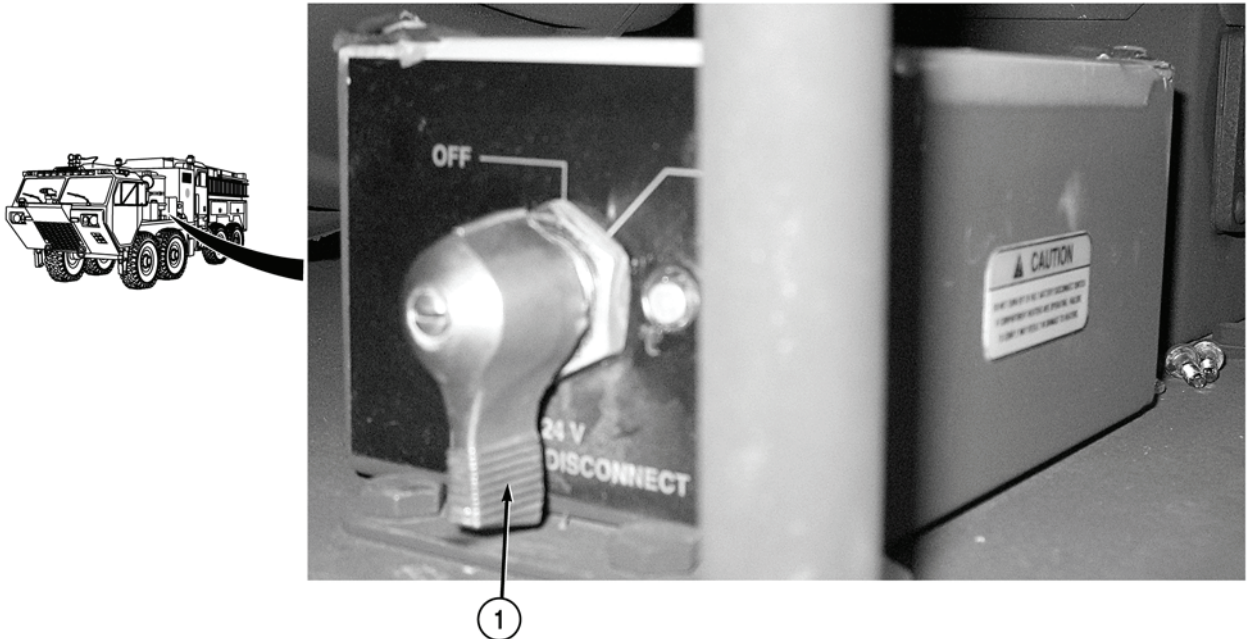
**DISCONNECT BATTERIES****WARNING**

**Remove all jewelry, such as rings, dog tags, bracelets, etc. If jewelry or tools contact electrical circuits, a direct short may result. Failure to comply may result in injury or death to personnel or damage to equipment.**

Turn battery disconnect switch (1) to OFF position.

**END OF TASK**

**CONNECT BATTERIES**

Turn battery disconnect switch (1) to ON position.

**END OF TASK**

**END OF WORK PACKAGE**



---

**OPERATOR MAINTENANCE**  
**CREW CAB AIR CONDITIONER OPERATION**

---

**STARTING CREW CAB AIR CONDITIONER**

1. Start generator (WP 0021).

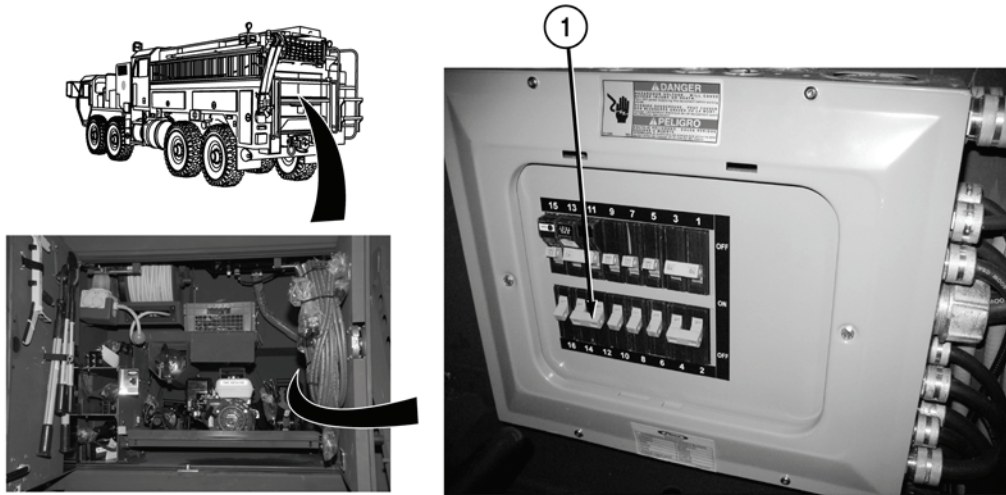

2. Put circuit breaker switches 12 and 14 (1) to ON position.

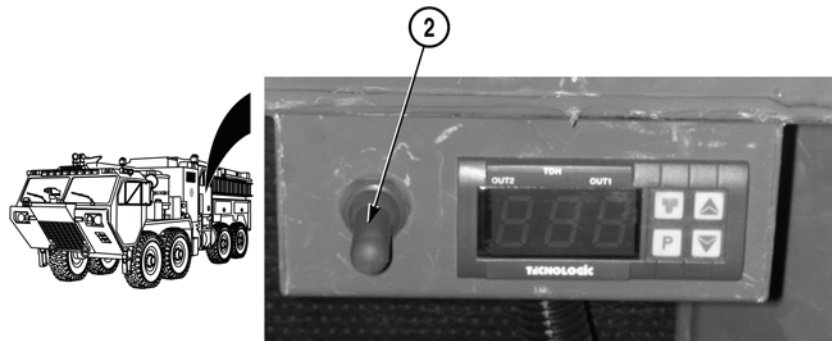

3. Put air conditioner/heater control panel switch (2) to ON position.

**END OF TASK****STOPPING CREW CAB AIR CONDITIONER**

1. Put circuit breaker switches 14 and 12 (1) to OFF position.
2. Turn generator off (WP 0021).

**END OF TASK****END OF WORK PACKAGE**





---

**OPERATOR MAINTENANCE****CREW CAB AIR CONDITIONER/HEATER CONTROL PANEL SET POINT PROGRAMMING**

---

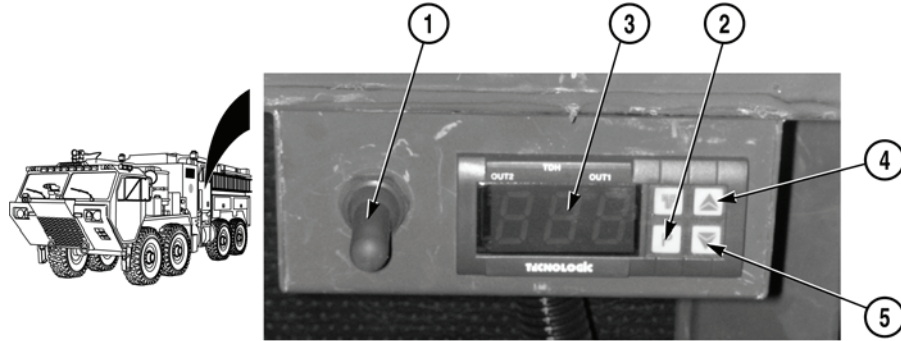
**NOTE**

Set point programming is used to set desired temperature in crew cab. Variance from set point is  $\pm 6^{\circ}\text{F}$  ( $3.33^{\circ}\text{C}$ ).

1. Put air conditioner/heater control panel switch (1) to ON position.
2. Press and release P key (2), to enter set point programming mode and display the value of set point on display (3).
3. Press UP key (4) or DOWN key (5) until desired temperature for turning on the air conditioner/heater is displayed on display (3).
4. System will return to normal operating mode five seconds after last key is pressed.

**END OF WORK PACKAGE**



---

**OPERATOR MAINTENANCE**  
**COMPARTMENT DOOR(S) OPEN/CLOSE**

---

**OPEN COMPARTMENT DOORS**

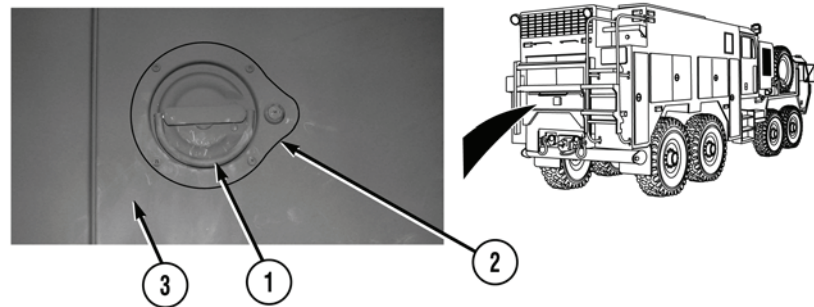

**WARNING**

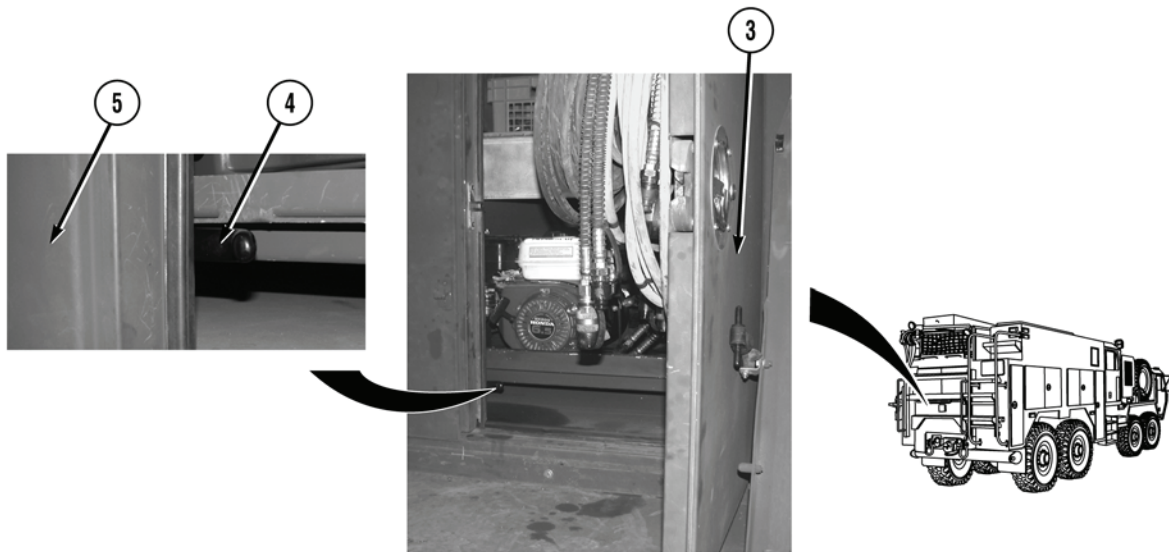

- **Items in compartments may have shifted or come loose during operations. Use caution and be aware that items may fall out while opening doors, causing injury to personnel.**
  - **When parked on side slope, items in side compartment may fall out. Use caution and be aware that items may fall out while opening doors, causing injury to personnel.**
  - **Side compartment doors that swing up are heavy. Make sure to have a firm grip on door when opening. Failure to comply may result in injury to personnel.**
1. Unstow rear work platform (WP 0014).
  2. Pull out D-ring (1) on door handle (2) and turn 1/4 turn clockwise.
  3. Slowly open compartment door (3).

**NOTE**

Perform Steps (4) and (5) if opening rear compartment door or left compartment door above rear wheels on passenger side of vehicle with no D-rings.

4. Push up on latch handle (4).
5. Slowly open compartment door (5).

**END OF TASK****CLOSE COMPARTMENT DOORS**

1. Ensure all items are properly stowed.

**NOTE**

Left compartment doors must be closed prior to closing right compartment doors.

2. Close compartment door (5).
3. Close compartment door (3) until click is heard.
4. Ensure compartment door (3) is securely latched.
5. Stow rear platform (WP 0014).

**END OF TASK****END OF WORK PACKAGE**

## OPERATOR MAINTENANCE

## UNSTOW/STOW EQUIPMENT (LADDER) RACK

## UNSTOW EQUIPMENT (LADDER) RACK

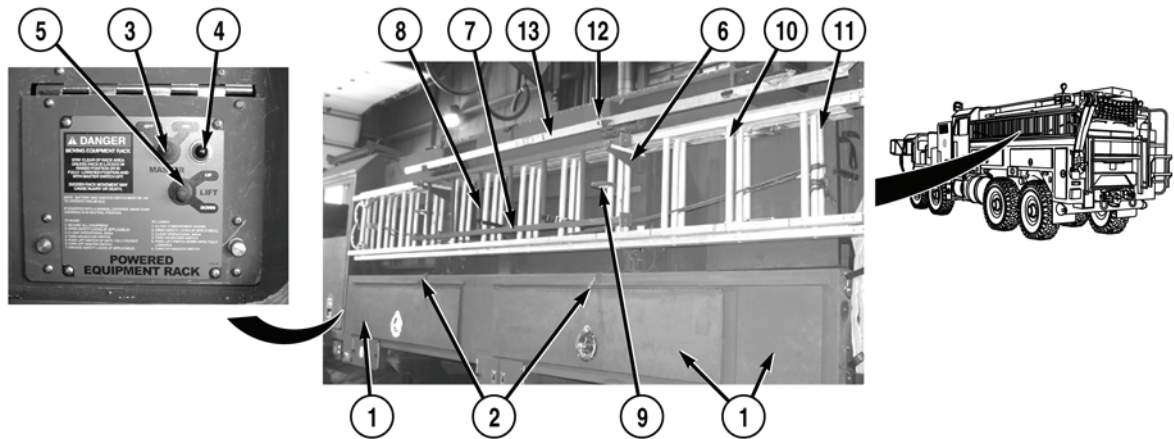
**NOTE**

Equipment (ladder) rack will operate in SERV. DRIVE mode with ENGINE switch in OFF position.

1. Close three driver side compartment doors (1) (WP 0010).
2. Pull two straps (2) to release locks.
3. Put MASTER SWITCH (3) to ON position. Indicator light (4) will illuminate.

**WARNING**

**Stay clear of equipment (ladder) rack area unless equipment (ladder) rack is locked in raised position or in fully lowered position with MASTER SWITCH OFF. Sudden equipment (ladder) rack movement may cause injury or death to personnel.**

4. Clear equipment (ladder) rack area and push LIFT SWITCH (5) down to lower equipment (ladder) rack (6).
5. Put MASTER SWITCH (3) to OFF position. Indicator light (4) will go out.
6. Remove two buckle straps (7) and vehicle maintenance ladder (8) from vehicle.
7. Pull two securing handles (9) straight out, turn 1/4 down, and remove 14 ft. (4 m) roof ladder (10) and 24 ft. (7 m) two-section extension ladder (11) from equipment (ladder) rack (6).
8. Remove pin (12) and 10 ft. (3 m) folding ladder (13) from equipment (ladder) rack (6).

**END OF TASK**

## STOW EQUIPMENT (LADDER) RACK

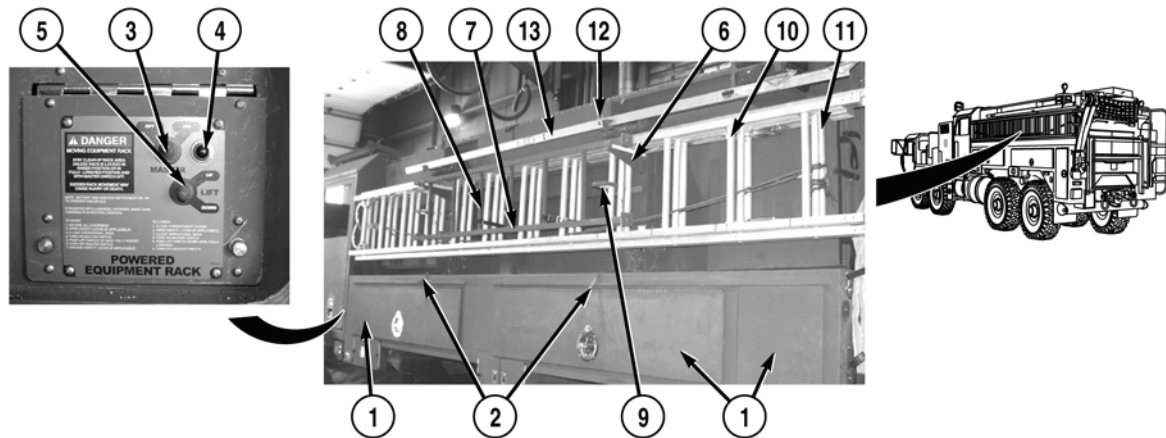
**NOTE**

- Line up arrows with supporting beam.
  - Equipment (ladder) rack will operate in SERV. DRIVE mode with ENGINE switch in OFF position.
1. Install 10 ft. (3 m) folding ladder (13) on equipment (ladder) rack (6) with pin (12).
  2. Install 24 ft. (7 m) two-section ladder (11), 14 ft. (4 m) roof ladder (10) on equipment (ladder) rack (6) by pulling two securing handles (9) straight out and turning 1/4 turn up.
  3. Install vehicle maintenance ladder (8) on vehicle with two buckle straps (7).
  4. Put MASTER SWITCH (3) to ON position. Indicator light (4) will illuminate.

**WARNING**

**Stay clear of equipment (ladder) rack area unless equipment (ladder) rack is locked in raised position or in fully lowered position with MASTER SWITCH OFF. Sudden equipment (ladder) rack movement may cause injury or death to personnel.**

**CAUTION**

**Ensure ladders are clear of crew cab. Ladder could contact crew cab causing damage to equipment.**

5. Clear rack area and push LIFT SWITCH (5) up to raise equipment (ladder) rack (6).
6. Put MASTER SWITCH (3) to OFF position. Indicator light (4) will go out.

**END OF TASK**

**END OF WORK PACKAGE**

---

**OPERATOR MAINTENANCE**  
**UNSTOW/STOW CREW CAB ACCESS STEPS**

---

**UNSTOW CREW CAB ACCESS STEPS**

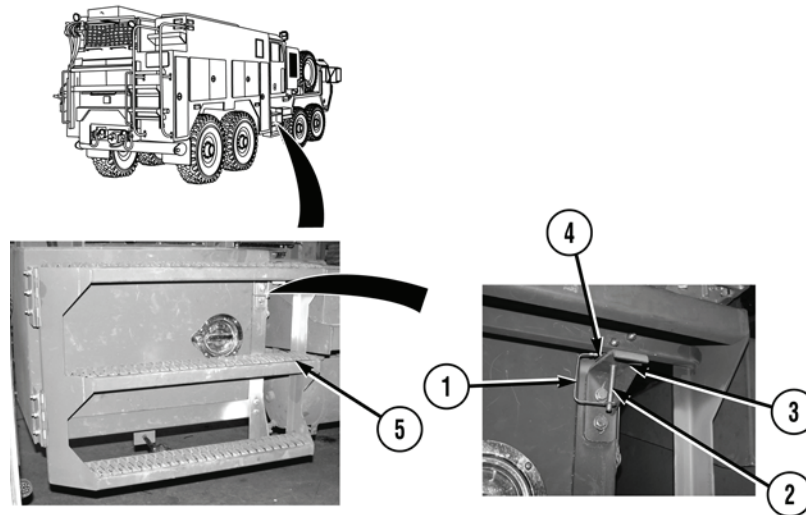

**WARNING**



**Care must always be taken when climbing ON and OFF vehicle. Always face vehicle, use steps and grab handles, maintain three points of contact with vehicle (two feet/one hand or two hands/one foot). Keep steps, grab handles, and walkways clean, and be extra careful in wet, icy, or muddy conditions. Failure to comply may result in personnel slipping and falling, causing injury or death to personnel.**

1. Unlock locking device (1) on locking pin (2).
2. Remove lock pin (2) from bracket (3) and bracket (4).
3. Swing crew cab access steps (5) outward until clear of vehicle.

**END OF TASK**

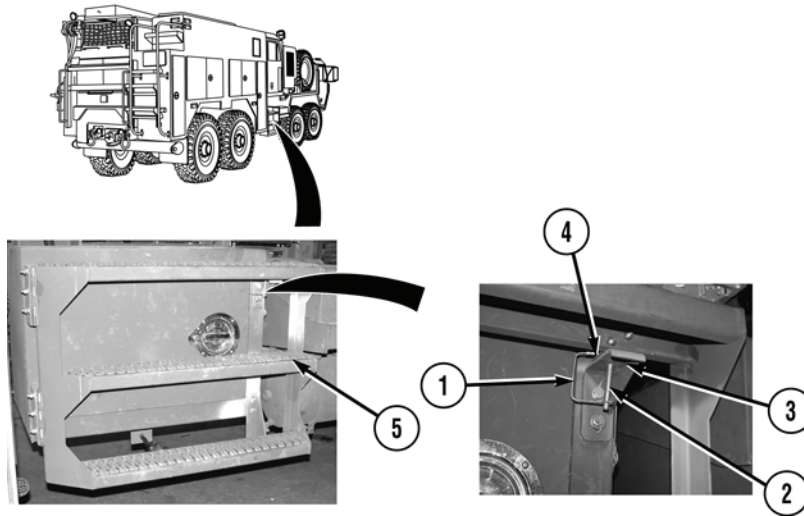
**STOW CREW CAB ACCESS STEPS**

1. Swing crew cab access steps (5) inward to vehicle and install lock pin (2) in bracket (4) and bracket (3).
2. Push locking device (1) over lock pin (2).
3. Pull out on crew cab access steps (5) to ensure crew cab access steps (5) are secure.

**END OF TASK****END OF WORK PACKAGE**



---

**OPERATOR MAINTENANCE**  
**UNSTOW/STOW RIGHT REAR ACCESS LADDER**

---

**UNSTOW RIGHT REAR ACCESS LADDER**

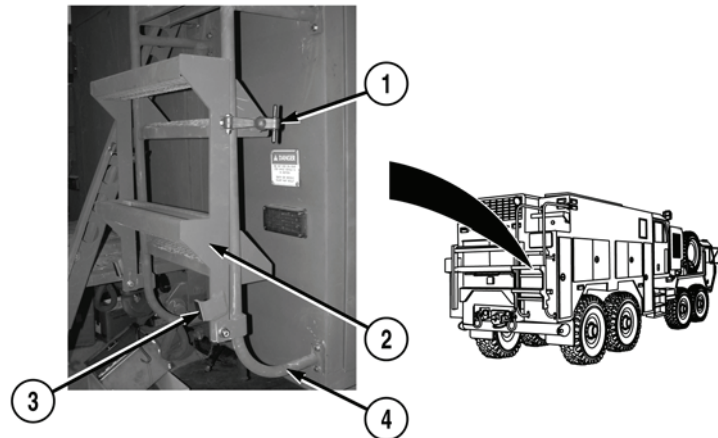

**WARNING**



Properly support right rear access ladder before removing rubber hook. Failure to comply may result in injury to personnel.

1. Release rubber hook (1) on ladder section (2).

**WARNING**



Care must always be taken when climbing ON and OFF vehicle. Always face vehicle, use steps and grab handles, maintain three points of contact with vehicle (two feet/one hand or two hands/one foot). Keep steps, grab handles, and walkways clean, and be extra careful in wet, icy, or muddy conditions. Failure to comply may result in personnel slipping and falling, causing injury or death to personnel.

2. Slowly lower right rear access ladder section (2) down until bumper (3) contacts handrail tubing (4).

**END OF TASK**

---

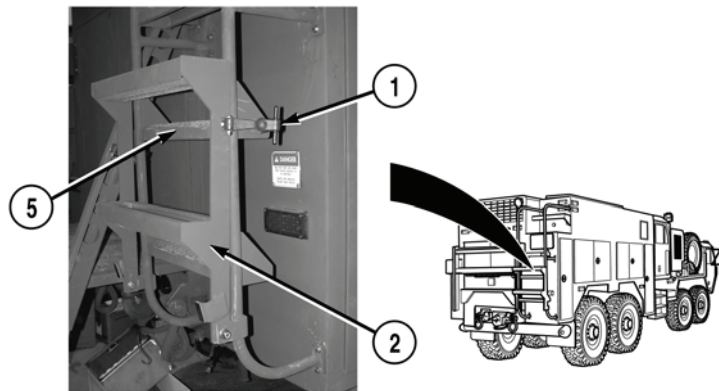
**STOW RIGHT REAR ACCESS LADDER**

1. Raise lower right rear access ladder section (2) to upper right rear ladder section (5) and connect rubber hook (1).
2. Pull on lower right rear access ladder (2) and ensure that lower right rear access ladder (2) is secure.

**END OF TASK**

**END OF WORK PACKAGE**

---

**OPERATOR MAINTENANCE**  
**UNSTOW/STOW REAR WORK PLATFORM**

---

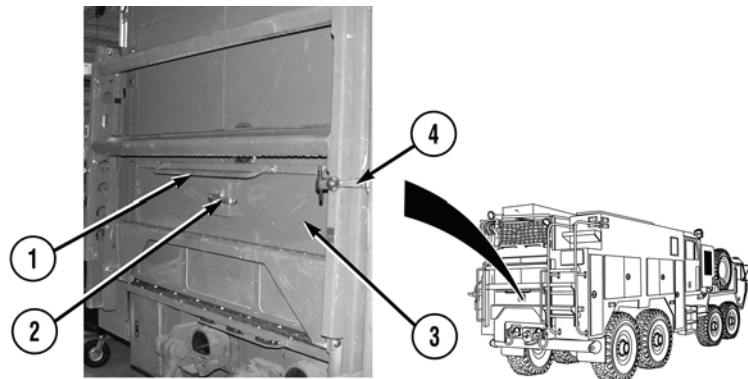
**UNSTOW REAR WORK PLATFORM****WARNING**

**Rear platform is heavy. When lockhandle is turned to unlock rear platform from vehicle and while rear platform is being lowered, operator must have firm grip of grab handle. Failure to comply may result in injury to personnel.**

1. With firm grip on grab handle (1), turn lockhandle (2) clockwise to unlock rear platform (3) from vehicle.

**WARNING**

**Operator must have firm grip on grab handle until rear platform is completely lowered. Failure to comply may result in injury to personnel.**

2. With both hands, grip grab handle (1), slowly pull grab handle (1) and lower rear platform (3).
3. Release two rubber hooks (4).

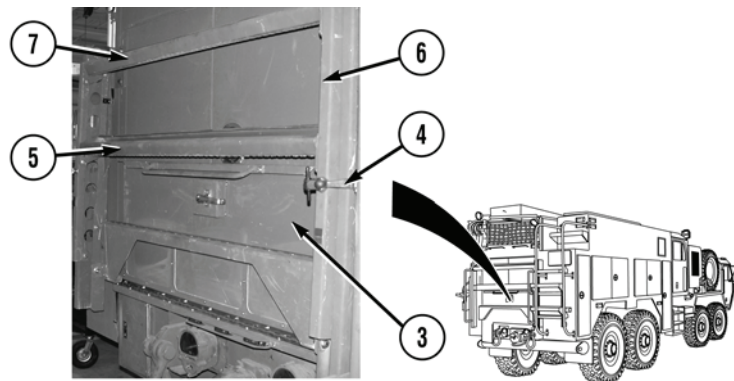
**WARNING**

Care must always be taken when climbing on and off vehicle. Always face vehicle, use steps and grab handles, maintain three points of contact with vehicle (two feet/one hand or two hands/one foot). Keep steps, grab handles, and walkways clean, and be extra careful in wet, icy, or muddy conditions. Failure to comply may result in personnel slipping and falling, causing injury or death to personnel.

4. With firm grip on upper step (5), slowly pull back and swing rear platform ladder (6) into operating position.

**END OF TASK****STOW REAR WORK PLATFORM**

1. With firm grip on lower step (7), raise rear platform ladder (6) and secure with two rubber hooks (4).

**WARNING**

Operator must have firm grip on grab handle until platform is locked securely to vehicle. Failure to comply may result in injury to personnel.

2. Push up rear ladder platform (3) until click is heard. Ensure rear ladder platform (3) is locked securely to vehicle.

**END OF TASK****END OF WORK PACKAGE**

---

**OPERATOR MAINTENANCE**  
**HOSE BED COVERS OPEN/CLOSE**

---

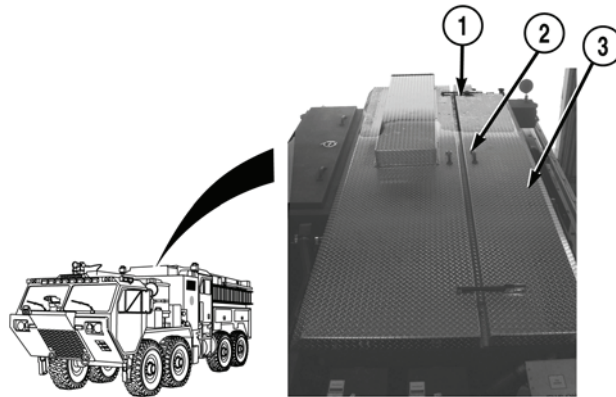
**OPEN HOSE BED COVERS****WARNING**

**Use extreme care when walking on hose bed cover and on top of vehicle. Be extra careful in wet, icy, or muddy conditions. Failure to comply may result in personnel slipping and falling, causing injury or death to personnel.**

1. Unstow right rear access ladder (WP 0013).
2. Release two latches (1).

**WARNING**

- **Firm grip must be kept on hose bed covers until support rods are installed to support hose bed covers. Failure to comply may result in injury to personnel.**
- **Use extra care when opening hose bed covers in the wind. Hose bed covers could close shut if wind blows them and support rods are not installed. Failure to comply may result in injury to personnel.**

3. With a firm grip on grab handle (2), lift up hose bed cover (3).

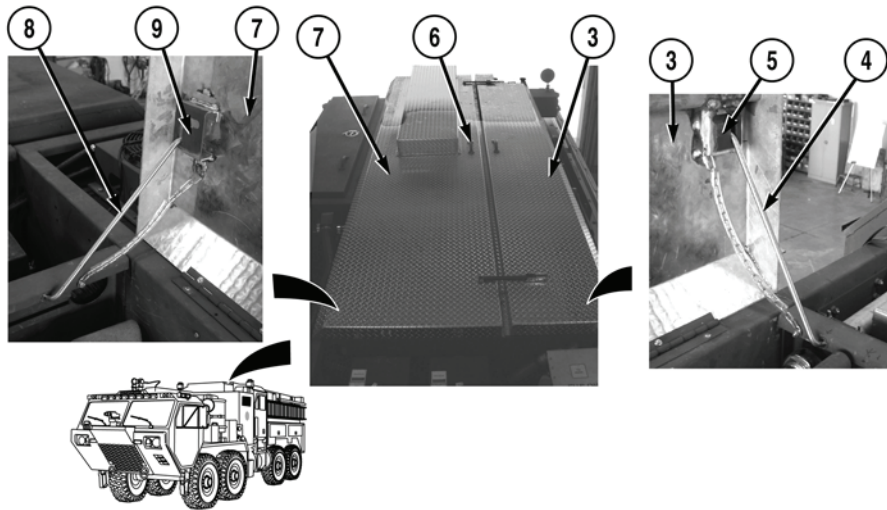

**WARNING**

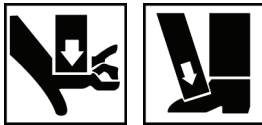

**Support rods must be installed to support hose bed cover when open. Failure to comply may result in hose bed cover falling shut, causing damage to equipment or injury to personnel.**

4. Install support rod (4) in rod catch (5) on hose bed cover (3).
5. With a firm grip on grab handle (6), lift up hose bed cover (7).
6. Install support rod (8) in rod catch (9) on hose bed cover (7).

**END OF TASK**

## CLOSE HOSE BED COVERS

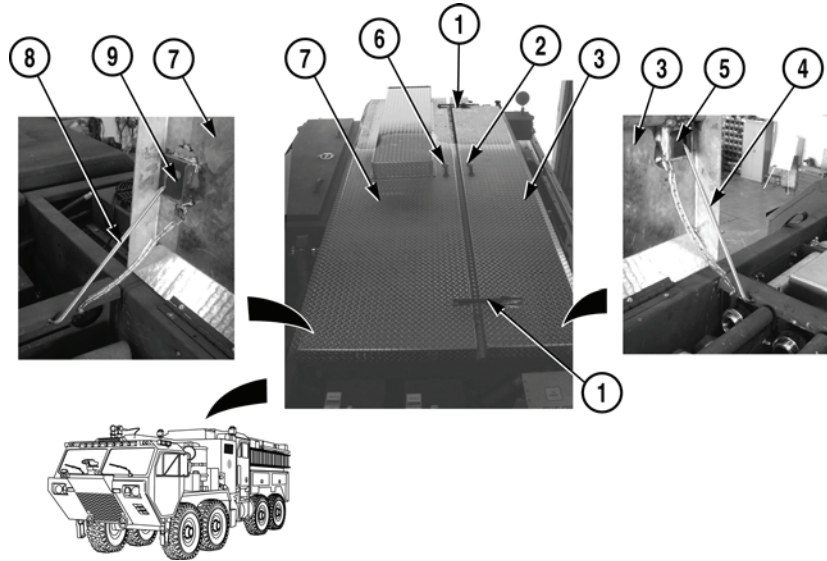
**WARNING**

**Firm grip must be kept on hose bed covers until support rods are removed and hose bed covers are closed. Failure to comply may result in injury to personnel.**

1. Remove support rod (8) from rod catch (9) on hose bed cover (7).
2. With a firm grip on grab handle (6), lower hose bed cover (7).
3. Remove support rod (4) from rod catch (5) on hose bed cover (3).
4. With a firm grip on grab handle (2), lower hose bed cover (3).
5. Connect two latches (1).
6. Stow right rear access ladder (WP 0013).

**END OF TASK**

**END OF WORK PACKAGE**





---

**OPERATOR MAINTENANCE**  
**UNSTOW/STOW PUMP OPERATOR'S PLATFORM**

---

**UNSTOW PUMP OPERATOR'S PLATFORM**

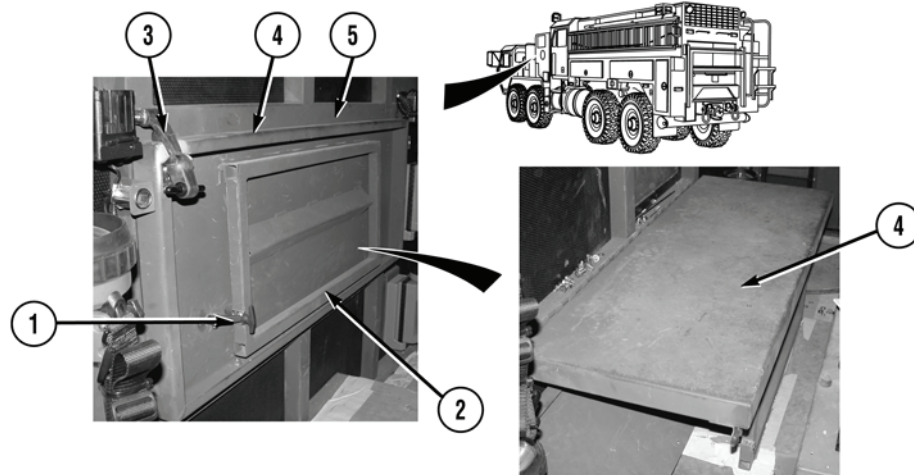

**WARNING**



**Fold-out platform support must be properly positioned in groove on crew cab floor or platform could collapse. Failure to comply may result in injury to personnel.**

**NOTE**

When pump operator's platform is lowered, fold-out platform support will swing down and be placed in groove on crew cab floor.

1. Ensure groove on crew cab floor is free of obstacles.
2. Release rubber hook (1) from fold-out platform support (2).
3. Release rubber hook (3) on pump operator's platform (4).
4. Pull pump operator's platform (4) away from crew cab wall (5) until fold-out platform support (2) is positioned in groove on crew cab floor.

**END OF TASK**

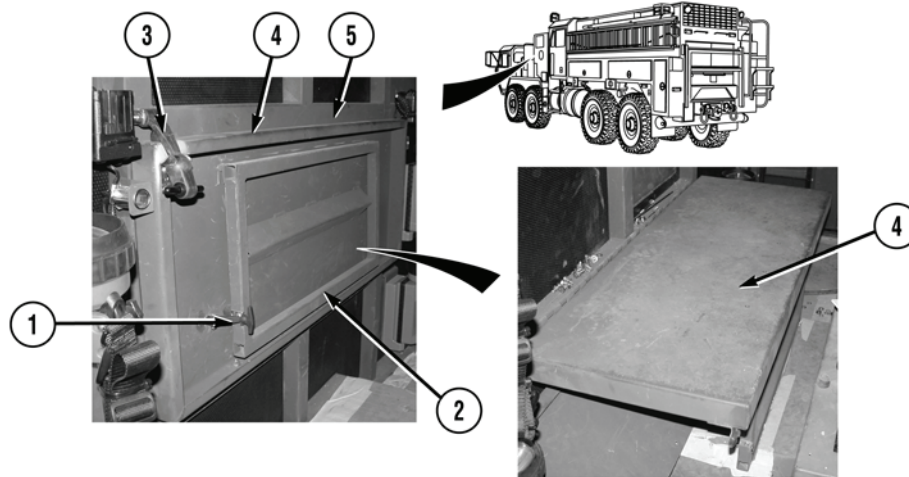
**STOW PUMP OPERATOR'S PLATFORM**

1. Lift front of pump operator's platform (4) until pump operator's platform (4) is flush with crew cab wall (5).
2. Connect rubber hook (3).
3. Connect rubber hook (1) to fold-out platform support (2).

**END OF TASK****END OF WORK PACKAGE**

---

**OPERATOR MAINTENANCE**  
**SINGGARS RADIO COVER OPEN/CLOSE**

---

**OPENING SINGGARS COMPARTMENT ACCESS DOOR**

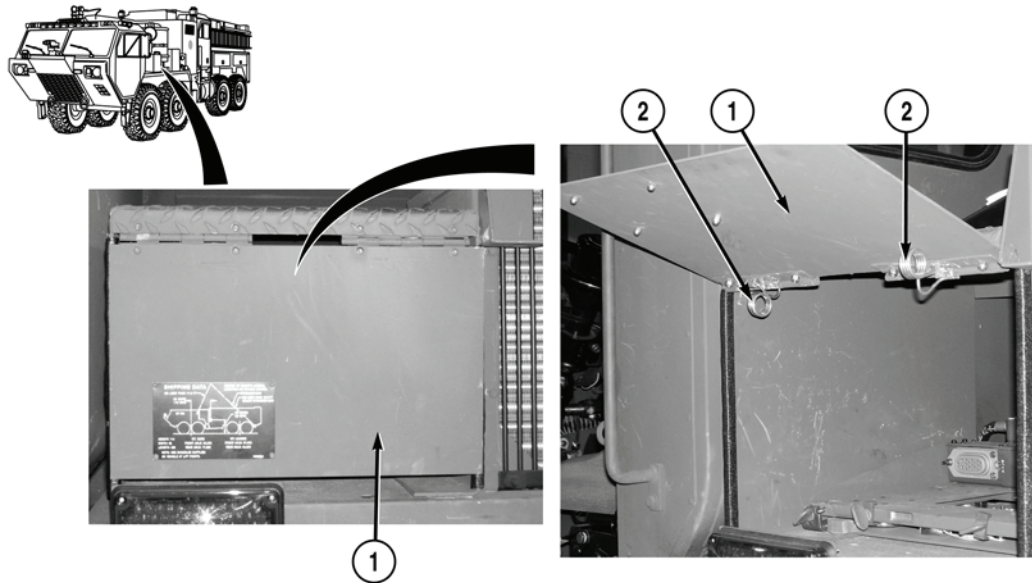

Lift up on SINGGARS compartment access door (1) until door is held in up position by door springs (2).

**END OF TASK**

**CLOSING SINGGARS COMPARTMENT ACCESS DOOR**

Push down on SINGGARS compartment access door cover (1) until door contacts SINGGARS compartment.

**END OF TASK**

**END OF WORK PACKAGE**



---

**OPERATOR MAINTENANCE**  
**CREW CAB ROOF HATCH OPEN/CLOSE**

---

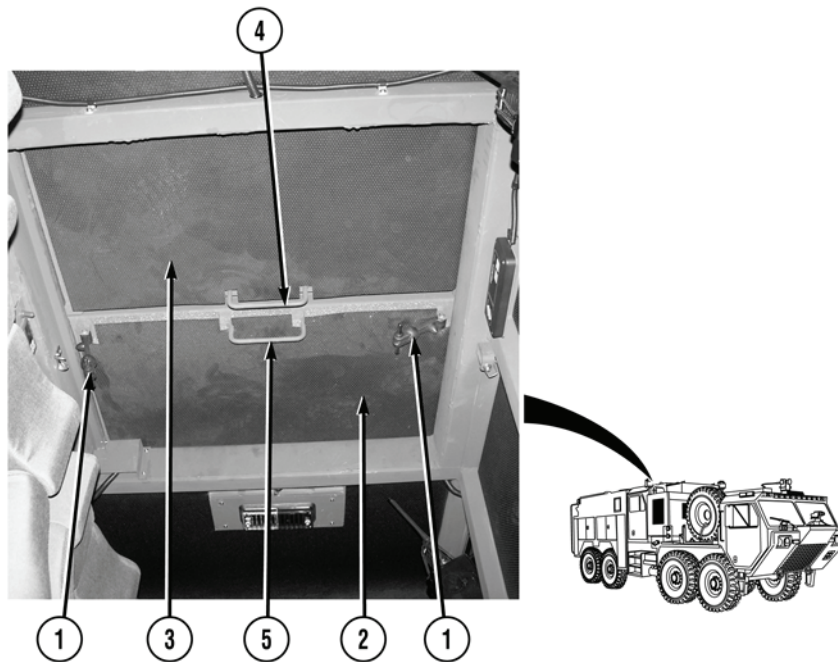
**OPEN CREW CAB ROOF HATCH**

1. Release two rubber hooks (1) and push open door (2).
2. Push open door (3).

**END OF TASK****CLOSE CREW CAB ROOF HATCH****NOTE**

Door (3) must be shut before door (2).

1. Using grab handle (4), lift and pull door (3) shut.
2. Using grab handle (5), lift and pull door (2) shut.
3. Connect two rubber hooks (1).

**END OF TASK****END OF WORK PACKAGE**



---

**OPERATOR MAINTENANCE**  
**PUMP OPERATOR'S PANEL OPEN/CLOSE**

---

**OPEN PUMP OPERATOR'S PANEL COVER**

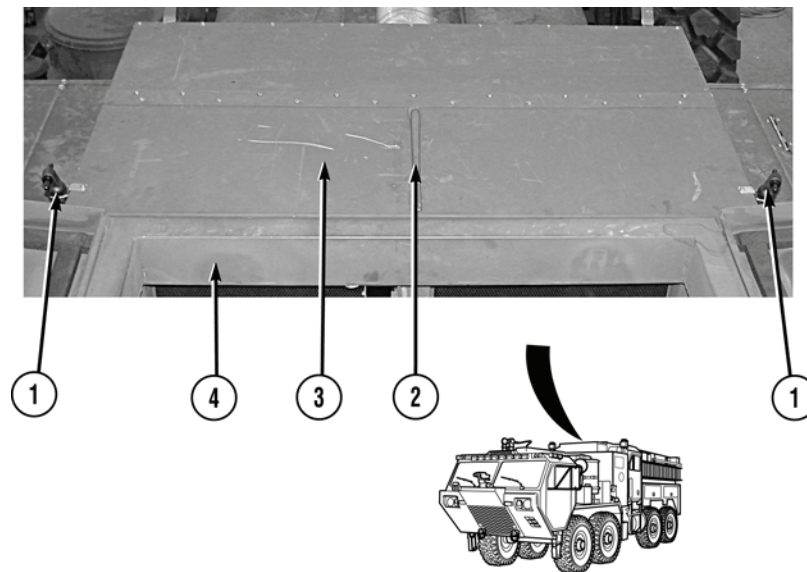

1. Open crew cab roof hatch (WP 0018).
2. Unstow pump operator's panel platform (WP 0016).
3. Release two rubber hooks (1), lift handle (2), and fold pump operator's panel cover (3) away from crew cab (4).

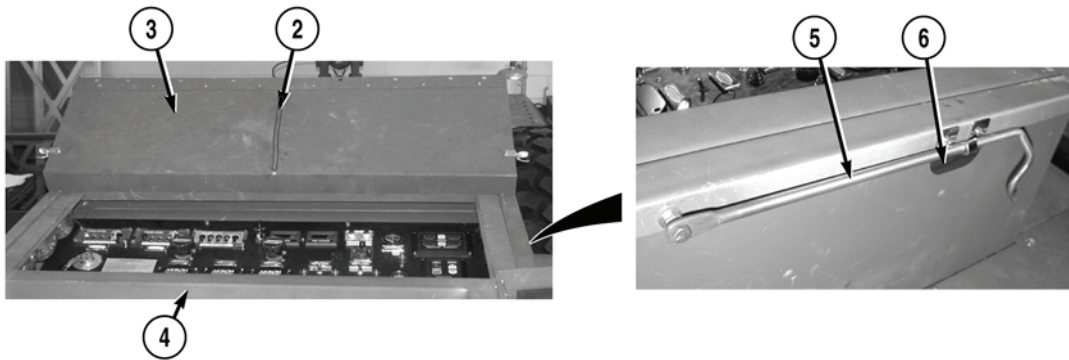

### NOTE

Perform Steps (4) through (7) if pump operator's panel gauges are not able to be read due to sunlight or other weather condition.

4. Pull handle (2) towards crew cab (4) to make pump panel cover (3) flat.
5. Lift up on handle (2).
6. Remove two support rods (5) from support rod catches (6).

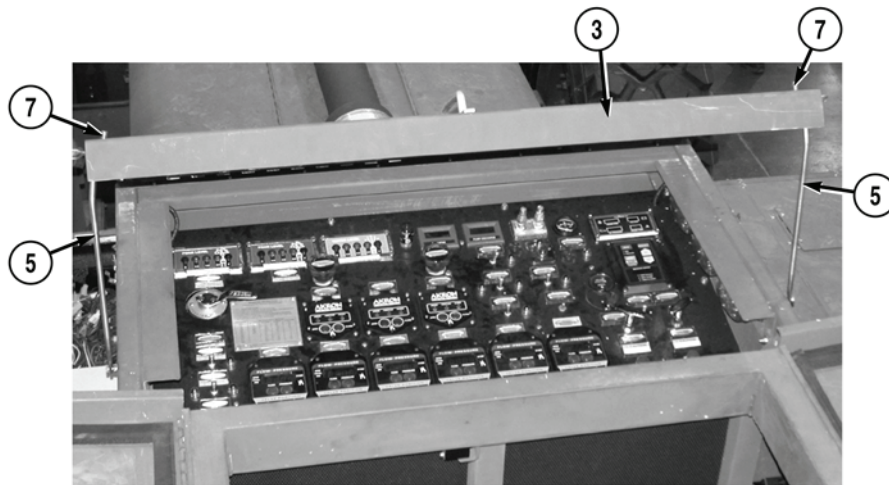

7. Install two support rods (5) in holes (7) on pump operator's panel cover (3).

**END OF TASK**

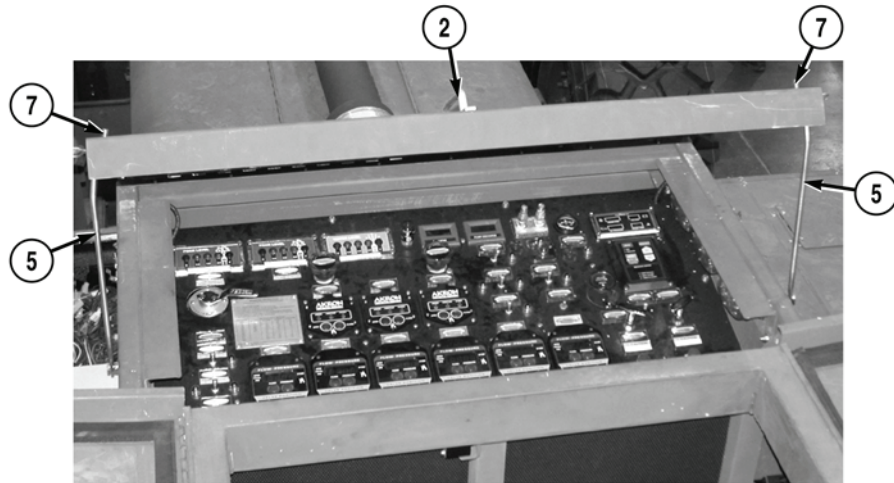

**CLOSE PUMP OPERATOR'S PANEL COVER****NOTE**

Perform Steps (1) through (3) to close pump operator's panel cover if pump operator's panel cover was opened due to sunlight or other weather conditions.

1. Lift up on handle (2) and remove two support rods (5) from holes (7).

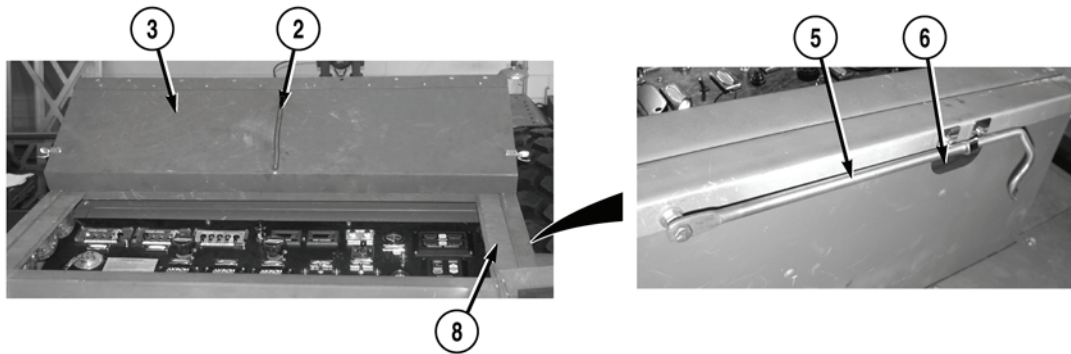

2. Install two support rods (5) in support rod catches (6).
3. Using handle (2), set pump operator's panel cover (3) down on pump operator's panel enclosure (8).

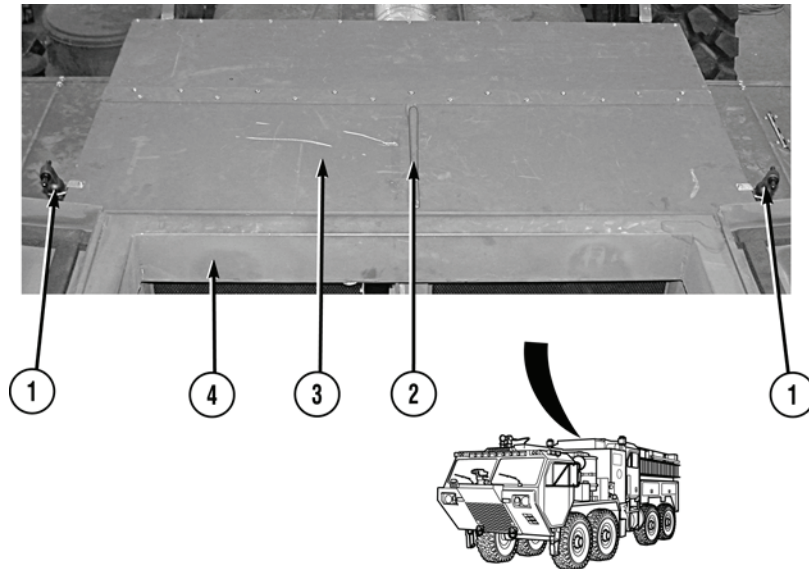

4. Pull handle (2) towards crew cab (4) to close pump operator's panel cover (3).
5. Connect with two rubber hooks (1).
6. Stow pump operator's panel platform (WP 0016).
7. Close crew cab roof hatch (WP 0018).

**END OF TASK**

**END OF WORK PACKAGE**

---

**OPERATOR MAINTENANCE****WATER TANK FILL**

---

**NOTE**

The TFFT can be filled four different ways.

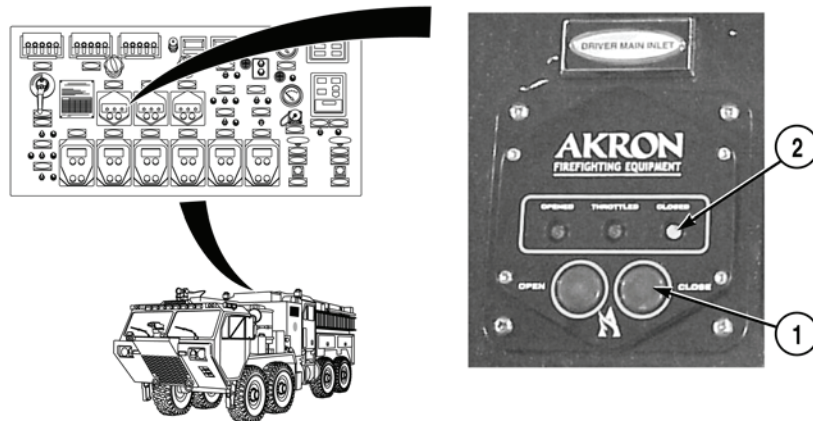
**MAIN INLET****NOTE**

- Valve is completely closed when red indicator light illuminates.
  - Main Inlet may be operated with either 5 in. (13 cm) or 3 in. (7.6 cm) soft suction hose.
  - 5 in. (13 cm) and 3 in. (7.6 cm) suction hoses operate the same way. 5 in. (13 cm) suction hose shown.
1. Push DRIVER MAIN INLET valve control CLOSE button (1) until red indicator light (2) illuminates.

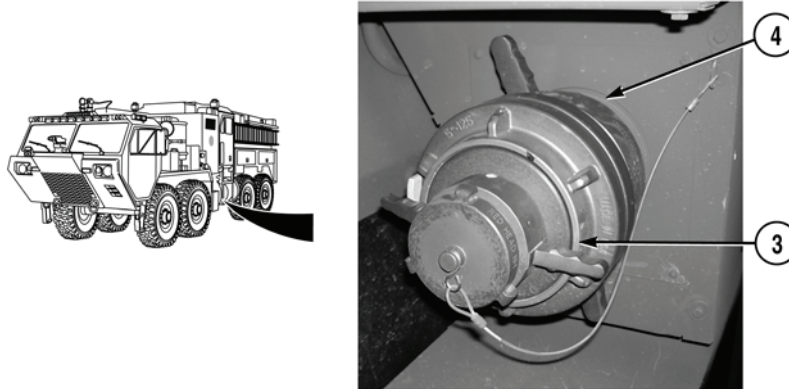

2. Remove cap (3) from driver main inlet (4).

### **WARNING**



**Do not use hard suction hose for Step (3). Hard suction hose will not hold pressure. Hose may fail and separate causing injury to personnel and/or damage to equipment.**

3. Connect 5 in. (13 cm) or 3 in. (7.6 cm) soft suction hose to driver main inlet (4) and positive water source.
4. Open supply valve on positive water source.

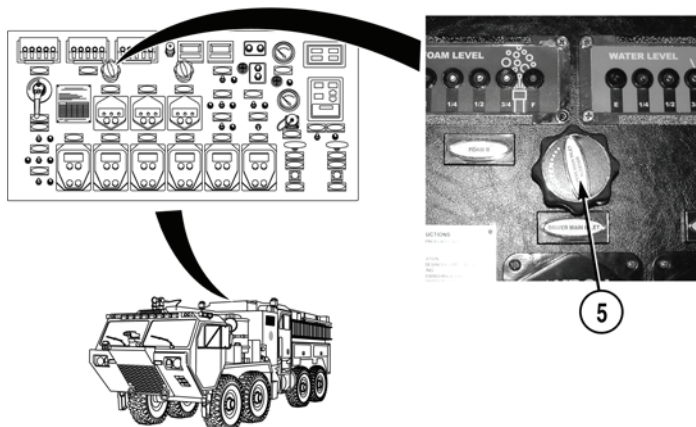

5. Crack open DRIVER MAIN INLET BLEEDER valve (5).

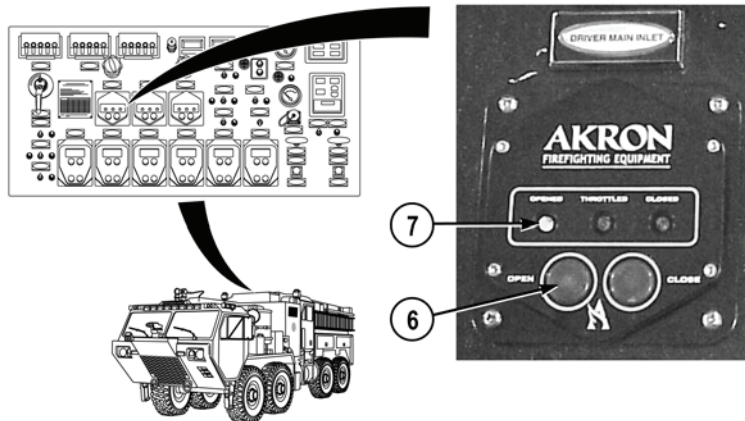

**NOTE**

Valve is completely open when green indicator light illuminates.

6. Push DRIVER SIDE MAIN INLET valve control OPEN button (6) until green indicator light (7) illuminates.

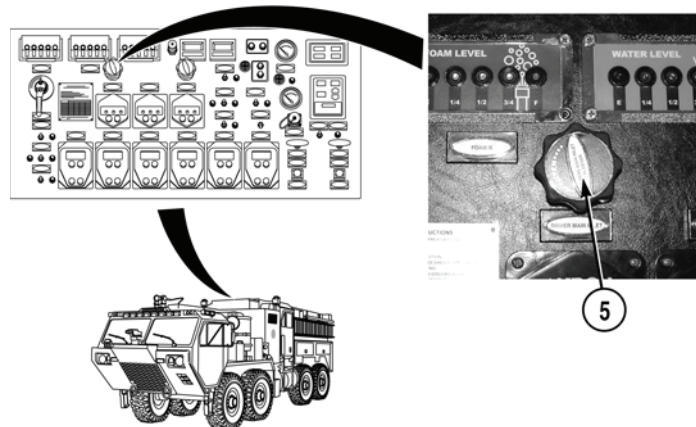

7. Once water discharges to ground, close DRIVER MAIN INLET BLEEDER valve (5).

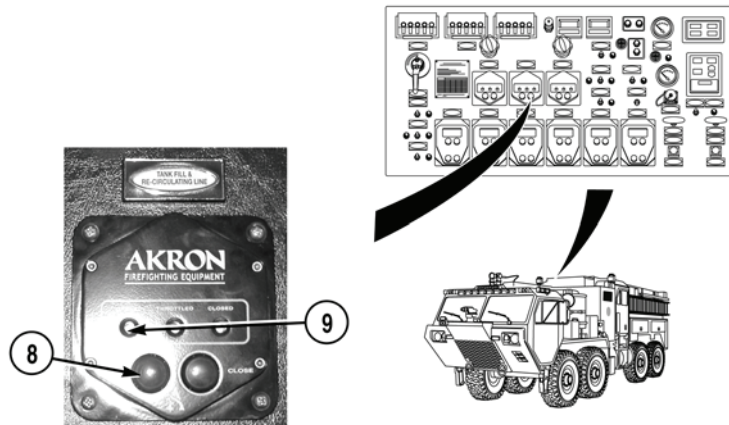

**NOTE**

Valve is completely open when green indicator light illuminates.

8. Push TANK FILL & RE-CIRCULATING LINE valve control OPEN button (8) until green indicator light (9) illuminates.

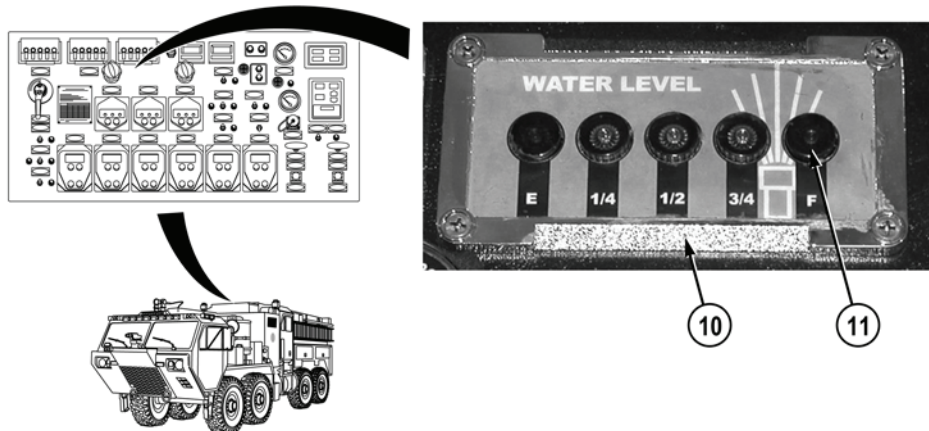

**⚠ CAUTION**

Monitor water level gauge while water tank is filling. Do not let water tank overflow. Failure to comply may result in damage to equipment.

9. Monitor water level gauge (10) until full (F) light (11) illuminates.

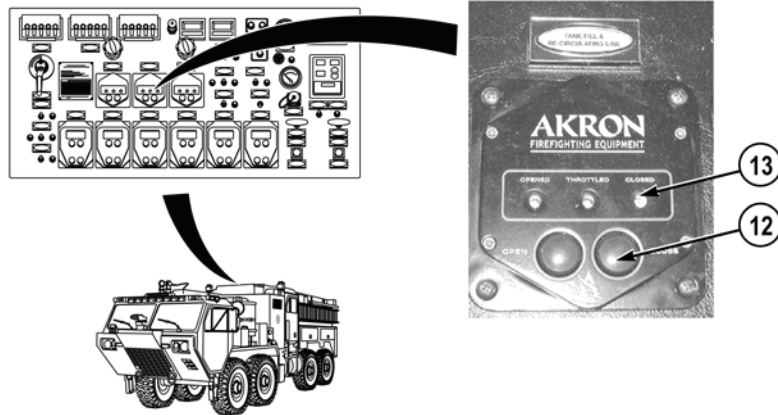

**NOTE**

Valve is completely closed when red indicator light illuminates.

10. Push TANK FILL & RE-CIRCULATING LINE valve control CLOSE button (12) until red indicator light (13) illuminates.

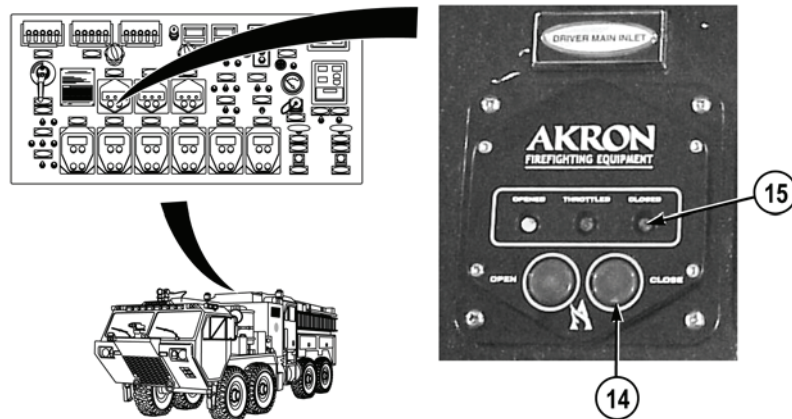

**NOTE**

Valve is completely closed when red indicator light illuminates.

11. Push DRIVER SIDE MAIN INLET valve control CLOSE button (14) until red indicator light (15) illuminates.
12. Close supply valve on positive water source.

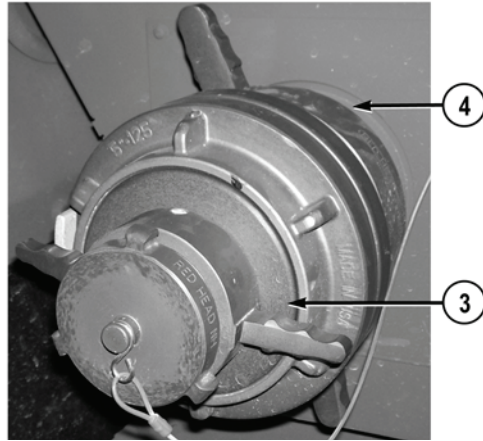

13. Disconnect 5 in. (13 cm) or 3 in. (7.6 cm) soft suction hose from main inlet (3).

14. Install cap (3) on main inlet (4).

#### END OF TASK

#### DIRECT TANK FILL

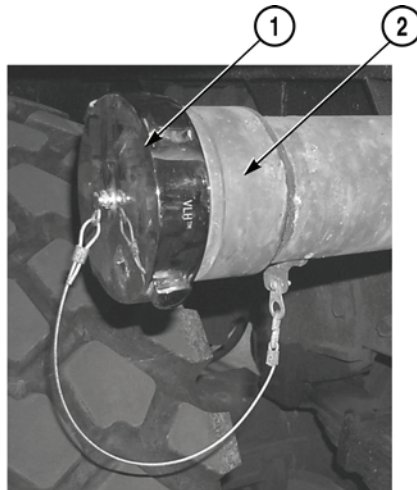

1. Remove cap (1) from direct tank fill (2).



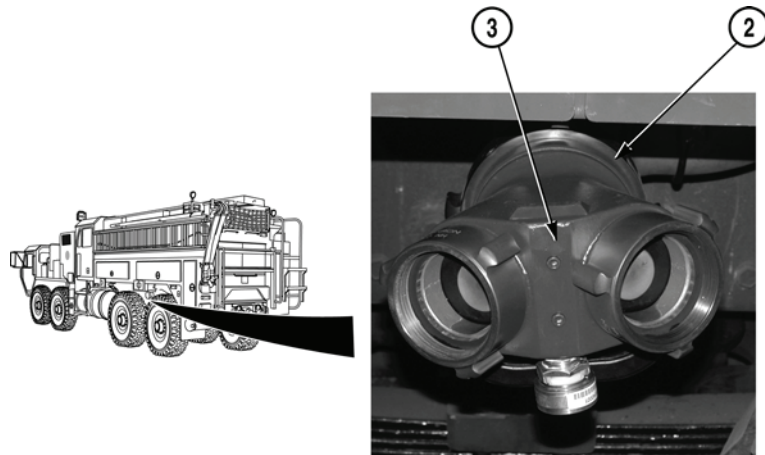

2. Install Siamese fitting (3) on direct tank fill (2).
3. Connect either one or two 3 in. (7.6 cm) soft suction hoses to Siamese fitting (3) and positive water source.
4. Open supply valve on positive water source.

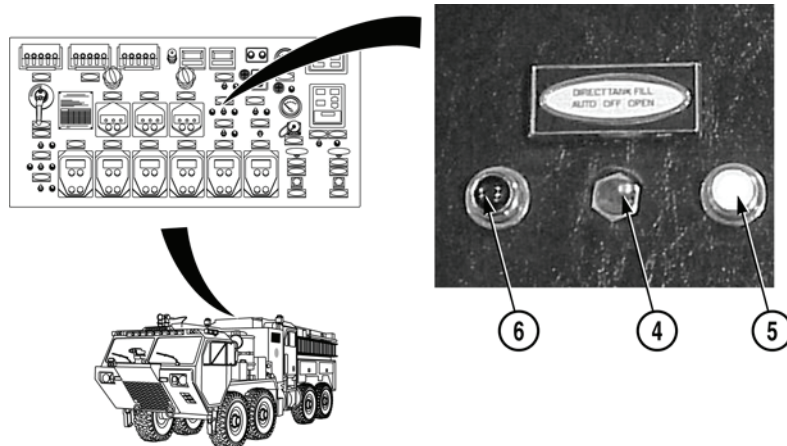

5. Put DIRECT TANK FILL switch (4) to AUTO position. Indicator lights (5) and (6) will illuminate.

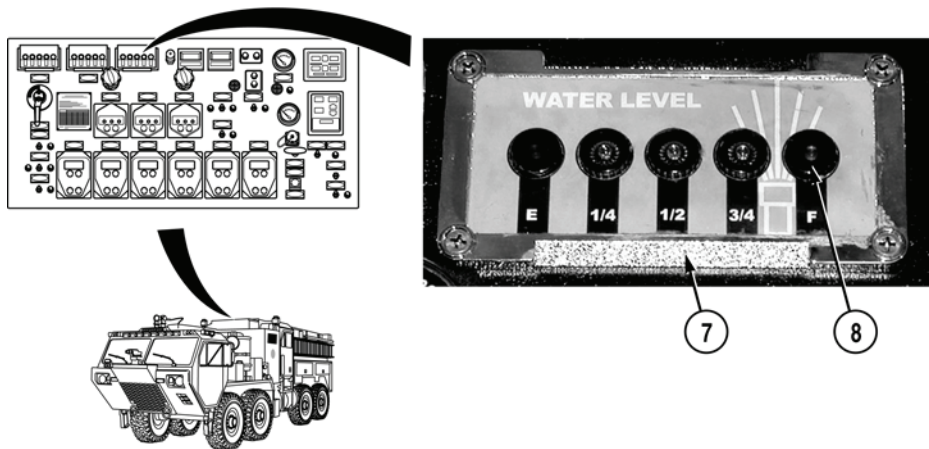

**⚠ CAUTION**

**Monitor water level gauge when water tank is filling. Do not let water tank overflow. Failure to comply may result in damage to equipment.**

- 6. Monitor water level gauge (7) until full (F) light (8) illuminates.
- 7. Indicator light (6) will go out.

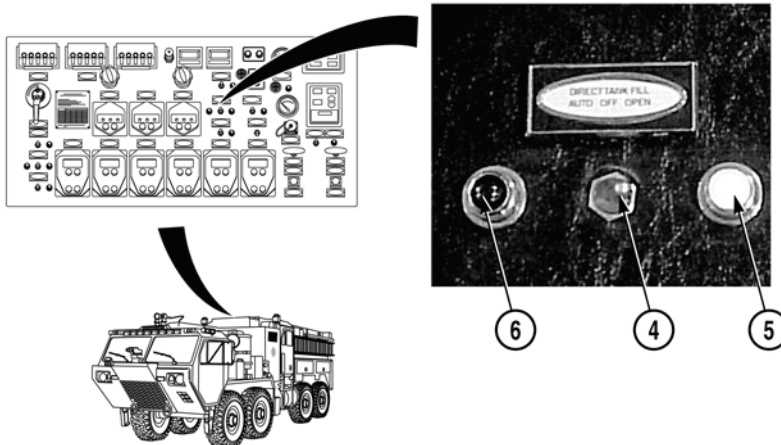

- 8. Put DIRECT TANK FILL switch (4) to OFF position. Indicator light (5) will go out.
- 9. Close supply valve on positive water source.

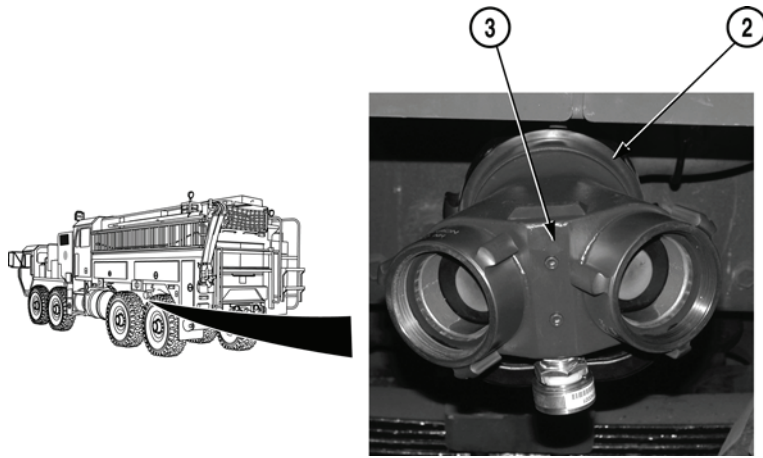

10. Disconnect one or two 3 in. (7.6 cm) soft suction hoses from Siamese fitting (3).
11. Remove Siamese fitting (3) from direct tank fill (2).

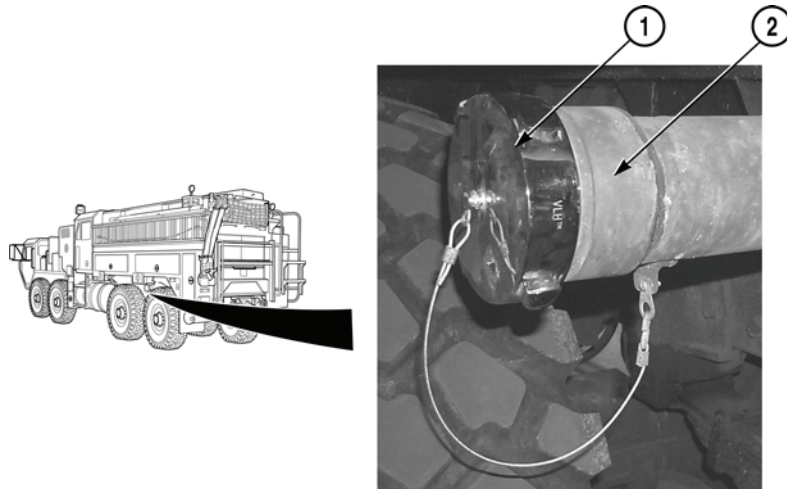

12. Install cap (1) on direct tank fill (2).

**END OF TASK**

## OVERHEAD FILL

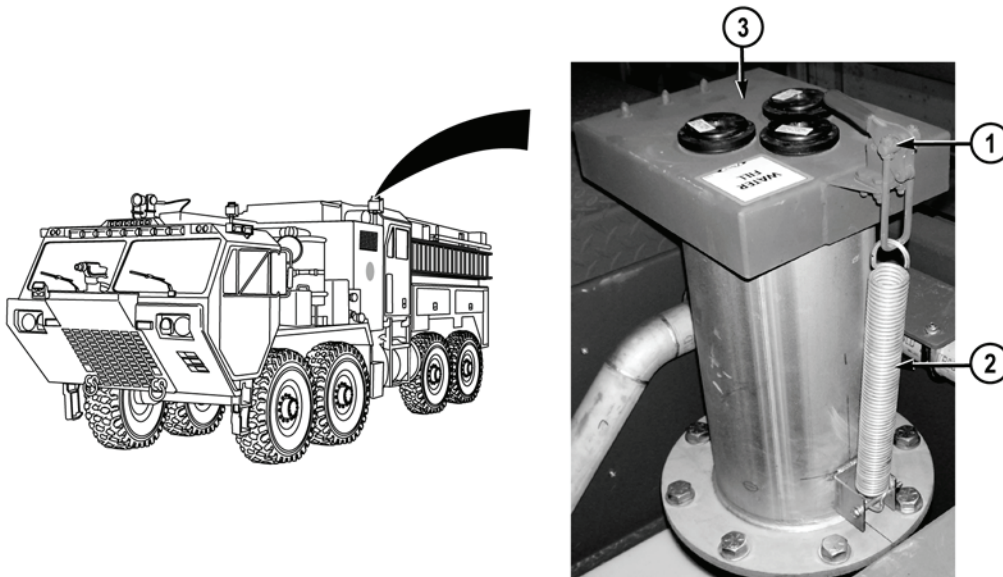

1. Unstow right rear access ladder (WP 0013).

**WARNING**

**Use extreme care when walking on hose bed cover and on top of vehicle. Be extra careful in wet, icy, or muddy conditions. Failure to comply may result in personnel slipping and falling, causing injury or death to personnel.**

2. Release latch (1) and disconnect extension spring (2) from latch (1).
3. Open WATER FILL cover (3).
4. Open supply valve on water source and fill water tank.
5. Close supply valve on water source when water tank is full.
6. Close WATER FILL cover (3).
7. Connect extension spring (2) to cover latch (1).
8. Close cover latch (1) on WATER FILL cover (3).
9. Stow right rear access ladder (WP 0013).

**END OF TASK**

**FILLING FROM DRAFT****WARNING**

**When backing up vehicle, one crew member must be in back of vehicle operating rear step buzzer to communicate with driver. Failure to comply may result in damage to equipment or injury or death to personnel.**

**NOTE**

- Pump performance is maximized with less than a 10 ft. (3 meters) vertical lift. As vertical lift increases above 10 ft. (3 m), maximum pump capacity will be reduced. Altitude also affects pump performance.
  - All valves, drain valves, and caps should be closed.
1. Position vehicle as close to water source as possible.
  2. Park vehicle (TM 9-2320-347-10).

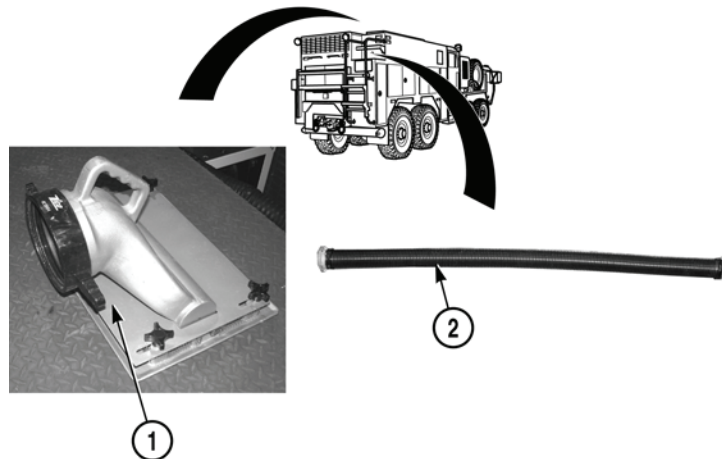
**CAUTION**

**Ensure suction hose strainer is clean and free from debris and obstructions. Failure to comply may result in damage to equipment.**

3. Connect suction hose strainer (1) to suction hose (2).

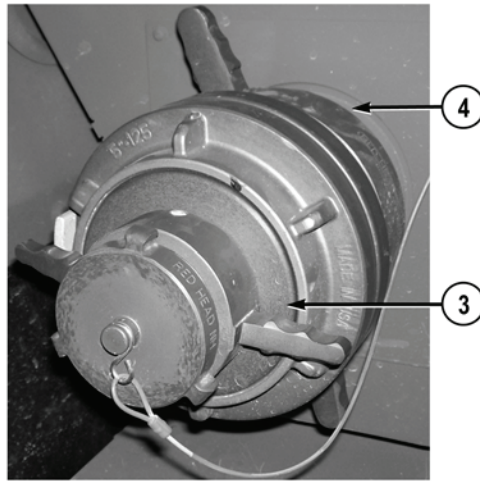

4. Remove cap (3) from DRIVER SIDE MAIN INLET (4).
5. Connect suction hose (2) to DRIVER SIDE MAIN INLET (4).

### **WARNING**



**Strainer must be positioned or suspended in water to prevent sucking of debris (sand, stones, mud, etc.). Strainer must be deep enough not to cause a whirlpool on surface of water. Failure to comply may result in injury or death to personnel and damage to equipment.**

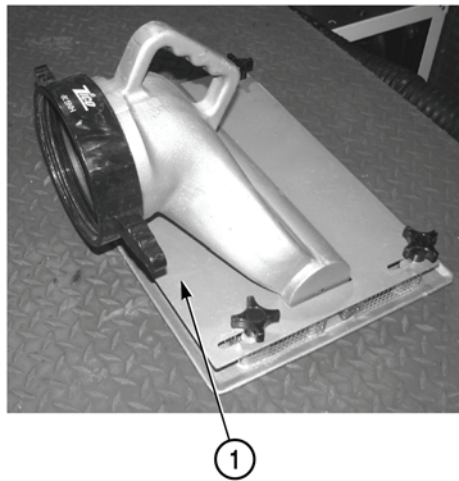

6. Position suction hose strainer (1) in water source.

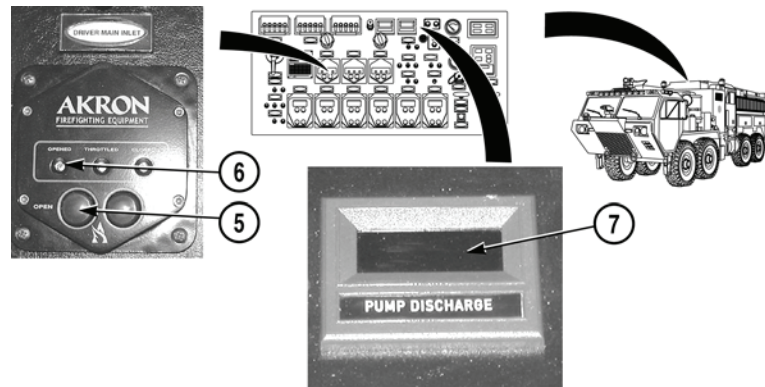

### WARNING



**Open and close all valves slowly during any procedure. Sudden changes in pressure may cause equipment to react faster than personnel can be alerted. Ensure surrounding personnel are aware of changes being made to settings on equipment. Failure to comply may result in injury or death to personnel and damage to equipment.**

7. Push DRIVER MAIN INLET valve control OPEN button (5) until indicator light (6) illuminates.
8. Start water pump engine (WP 0022).
9. Prime water pump (WP 0023) until pressure is on PUMP DISCHARGE gauge (7).
10. Set pressure governor (WP 0024).

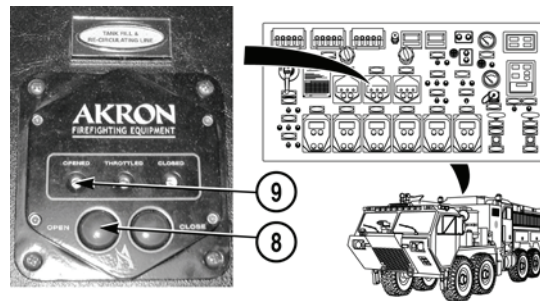

11. Push TANK FILL & RE-CIRCULATING LINE valve control OPEN button (8) until green indicator light (9) illuminates.

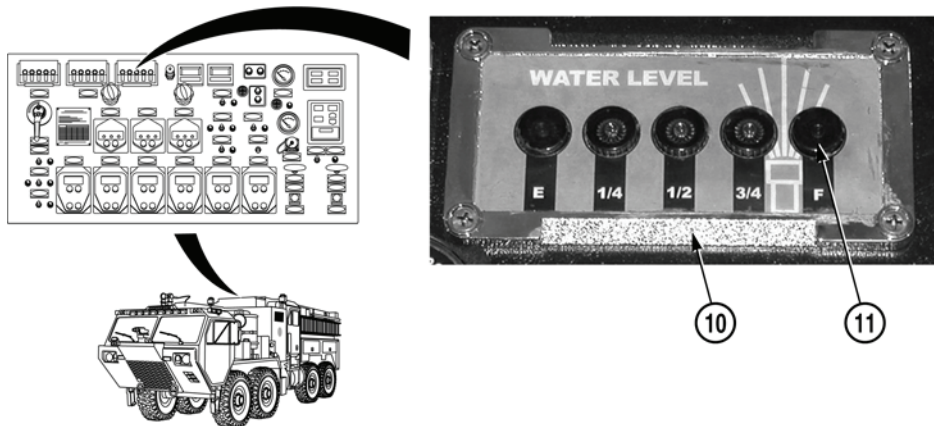

12. Monitor water level gauge (10) until full (F) light (11) illuminates.

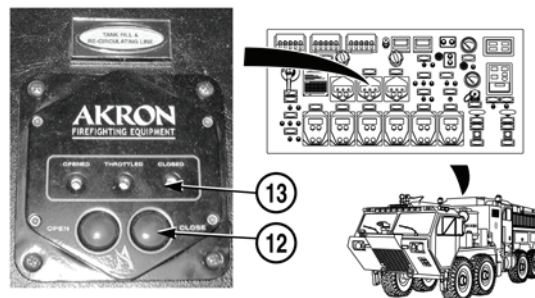

13. Push TANK FILL & RE-CIRCULATING LINE valve control CLOSE button (12) until red indicator light (13) illuminates.

14. Stop water pump engine (WP 0022).



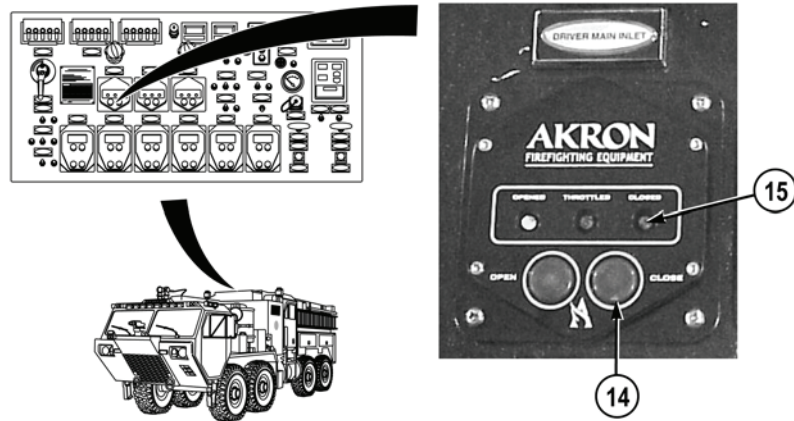

15. Push DRIVER MAIN INLET valve control CLOSE button (14) until indicator light (15) illuminates.

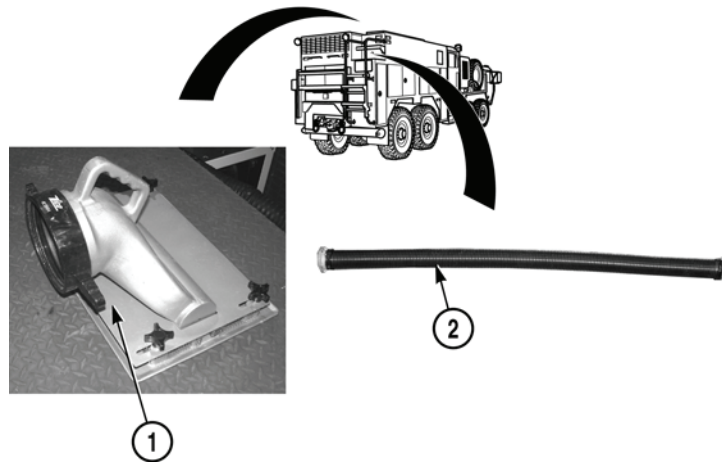

16. Remove suction hose strainer (1) from water source.

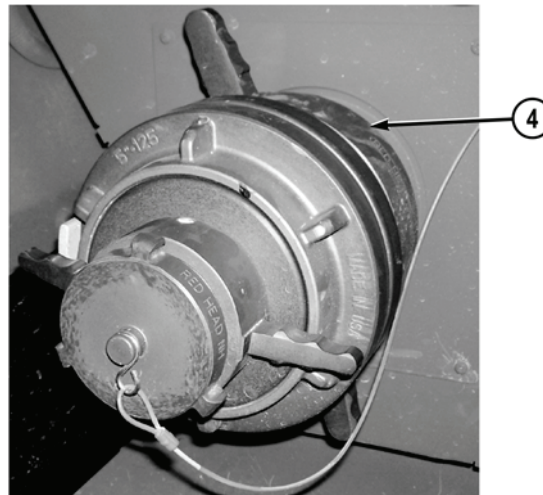

17. Remove suction hose (2) from DRIVER SIDE MAIN INLET (4).

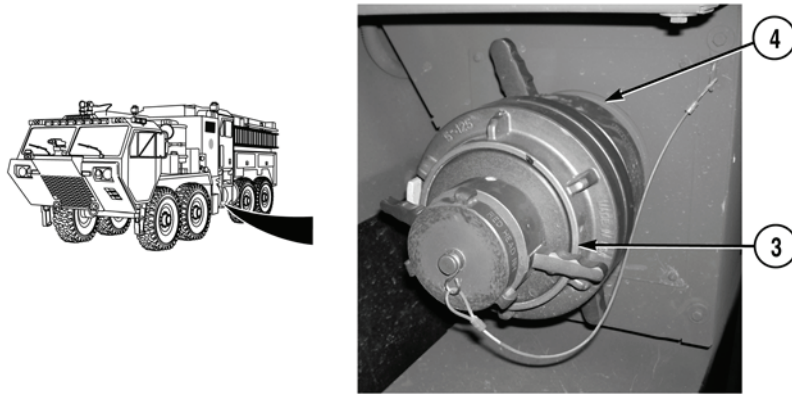

18. Install cap (3) on DRIVER SIDE MAIN INLET (4).

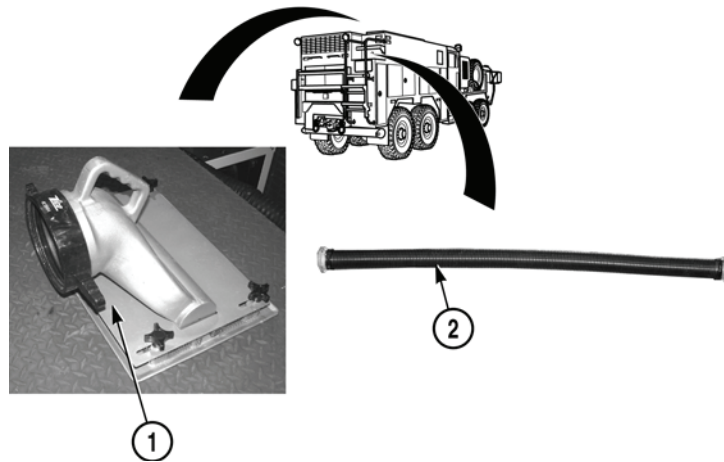

19. Remove suction hose strainer (1) from suction hose (2).

**END OF TASK**

**END OF WORK PACKAGE**

---

**OPERATOR MAINTENANCE**

**STARTING/STOPPING HYDRAULIC GENERATOR**

---

**STARTING HYDRAULIC GENERATOR**

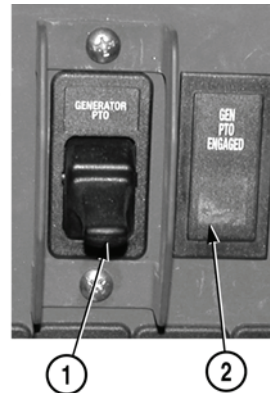
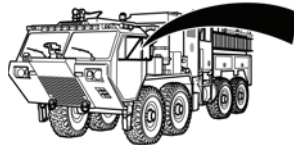

1. Start vehicle engine (TM 9-2320-347-10).
2. Put GENERATOR PTO switch (1) to ON position. Indicator light (2) will illuminate.

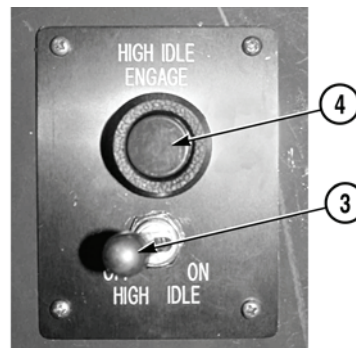

3. Put HIGH IDLE switch (3) to ON position. Indicator light (4) will illuminate.

**NOTE**

Perform Steps (4) through (7) to put load on hydraulic generator.

4. Unstow rear work platform (WP 0014).
5. Open rear compartment door (WP 0010).

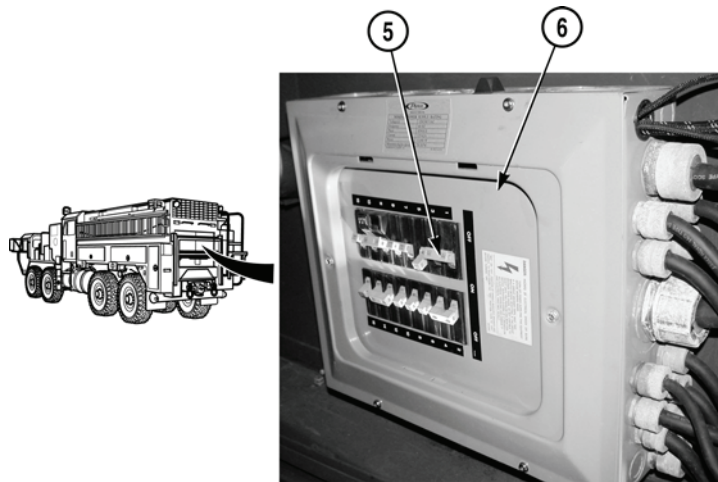

6. Turn main breaker (5) on breaker box (6) to ON position.

### **WARNING**



**Use extreme care when working around 120 VAC outlets. Personnel may get electrocuted if 120 VAC outlet is exposed to water. Failure to comply may result in injury or death to personnel.**

### **NOTE**

Refer to circuit directory on rear module door for desired breaker.

7. Turn desired breaker to ON position.

### **END OF TASK**

### **STOPPING HYDRAULIC GENERATOR**

### **CAUTION**

**All breakers must be turned off prior to turning main breaker OFF. Failure to comply may result in damage to equipment.**

### **NOTE**

Perform Steps (1) through (4) to remove load from hydraulic generator.

1. Turn all breakers to OFF position.
2. Turn main breaker (5) on breaker box (6) to OFF position.
3. Close rear compartment door (WP 0010).
4. Stow rear work platform (WP 0014).

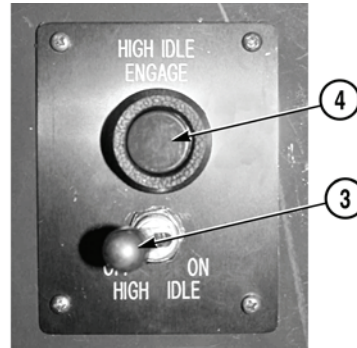
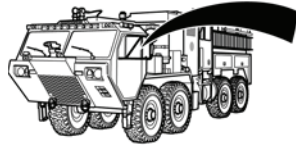

5. Put HIGH IDLE switch (3) to OFF position. Indicator light (4) will go out.

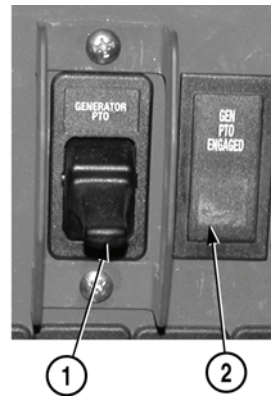

6. Put GENERATOR PTO switch (1) to OFF position. Indicator light (2) will go out.

**END OF TASK**

**END OF WORK PACKAGE**



---

**OPERATOR MAINTENANCE****STARTING/STOPPING WATER PUMP ENGINE (CAB INSTRUMENT PANEL  
AND PUMP OPERATOR'S PANEL)**

---

**STARTING WATER PUMP ENGINE (ENGAGE PUMP)****WARNING**

Do not leave cab or attempt any pumping operations until all required indicator lights are illuminated. Failure to comply may result in injury to personnel and damage to equipment.

** CAUTION**

- The water pump is constantly engaged and operates whenever the water pump engine is running. At least one water inlet valve to water pump must be opened whenever the pump engine is running. A pressure reading on the pump discharge gauge (engine running) indicates adequate water supply to the pump for cooling. Failure to comply may result in pump overheating and/or damage to equipment.
  - During operations above 32°F (0°C), ensure pump house cooling winterization cover is removed from left side pump house panel. Failure to comply may result in damage to equipment.
1. Ensure water tank is full or water source is connected to vehicle.
  2. Start vehicle engine (TM 9-2320-347-10).
  3. Open at least one water source to water pump (tank to pump, main inlet or auxiliary inlet).

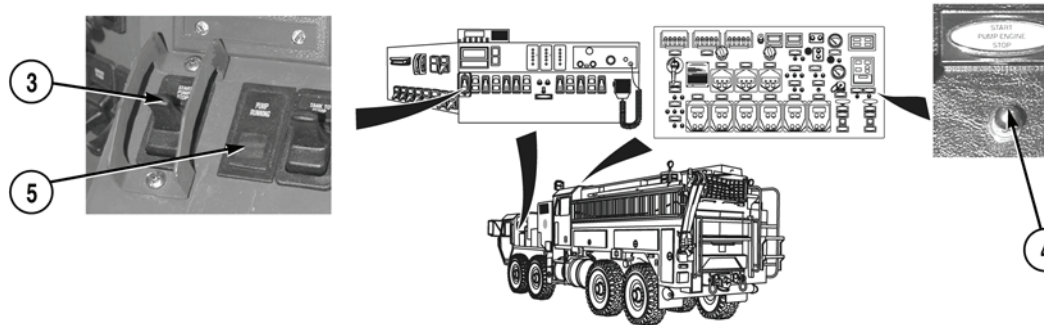

**⚠ CAUTION**

If water pump engine fails to start, wait 15 seconds prior to next start attempt to allow starter to cool. Do not turn ignition switch to START position while water pump engine is rotating. Failure to comply may result in damage to equipment.

**NOTE**

If water pump engine fails to start, return engine switch to OFF position before attempting to re-start.

4. Put START PUMP STOP switch (3) or PUMP ENGINE switch (4) to START position. Indicator light (5) or (6) will illuminate.
5. Prime water pump (WP 0023).



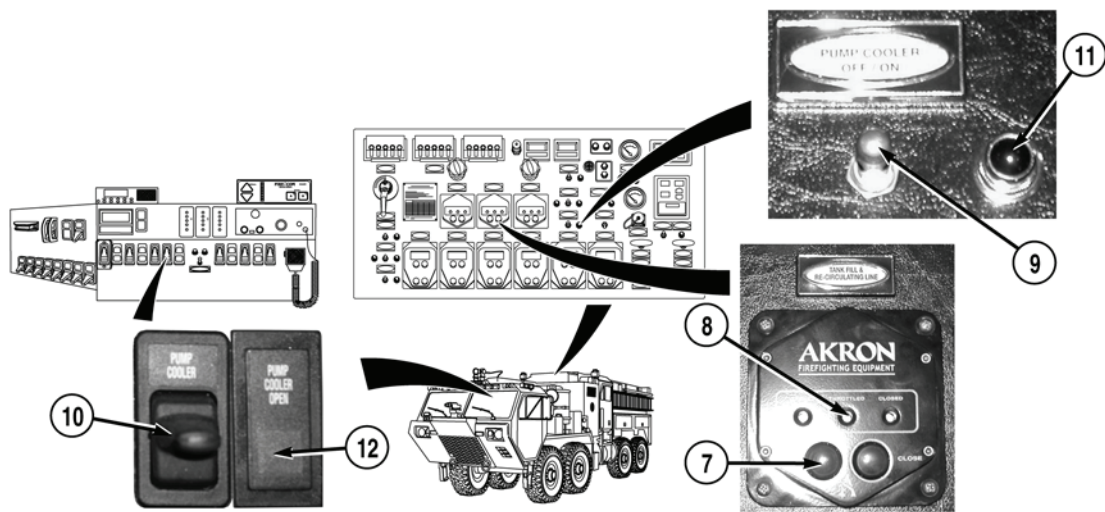

### **CAUTION**

- When water pump is engaged, water must be discharged or re-circulated. Failure to comply may result in damage to water pump.
- When foam operation is engaged or when in pump and roll mode, PUMP COOLER switch must be activated. Failure to comply may result in damage to equipment.

### **NOTE**

- Perform Step (6) for **water** only mode.
  - Perform Step (7) for **foam** operation or pump and roll mode.
  - Water or foam solution will discharge to ground when PUMP COOLER switch is activated.
6. Partially open TANK FILL & RE-CIRCULATING LINE valve control (7). Indicator light (8) will illuminate.
  7. Put PUMP COOLER switch (9) or (10) to OPEN position. Indicator light (11) or (12) will illuminate.

**END OF TASK**

**STOPPING WATER PUMP ENGINE (DISENGAGE PUMP)****WARNING**

**Open and close all valves slowly during any procedure. Sudden changes in pressure may cause equipment to react faster than personnel can be alerted. Ensure surrounding personnel are aware of changes being made to settings on equipment. Failure to comply may result in injury or death to personnel and damage to equipment.**

1. Ensure to close all discharge valves.
2. Reduce pump pressure by gradually reducing engine RPM to idle.

**CAUTION**

**Before shutting down water pump engine, run engine at 800 to 1000 RPM with no-load for three to five minutes to allow turbocharger to slow down and cool off. Turbocharger may be damaged if not allowed to cool off.**

3. Set pressure governor until tachometer reads 800 to 1,000 RPM (WP 0024).
4. Run engine at 800 to 1000 RPM for three to five minutes.
5. Set pressure governor to idle (WP 0024).
6. Idle water pump engine for 30 seconds.

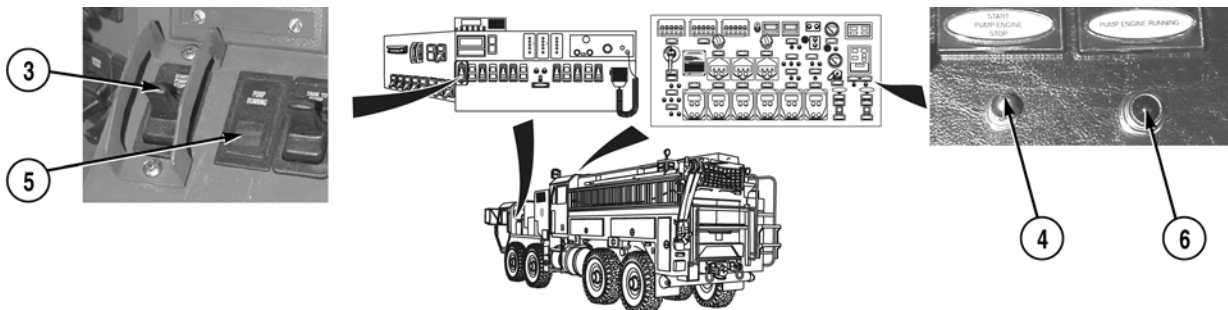

7. With water pump engine at idle, put either START PUMP STOP switch (3) or PUMP ENGINE switch (4) to STOP position. Indicator light (5) or (6) will go out.
8. Close all inlet valves.
9. Ensure instrument panel is in standby mode (WP 0032).
10. Shut off vehicle engine (TM 9-2320-347-10).
11. If mission is complete, perform post operation procedures (WP 0041).

**END OF TASK****END OF WORK PACKAGE**

## OPERATOR MAINTENANCE

## PRIMING WATER PUMP

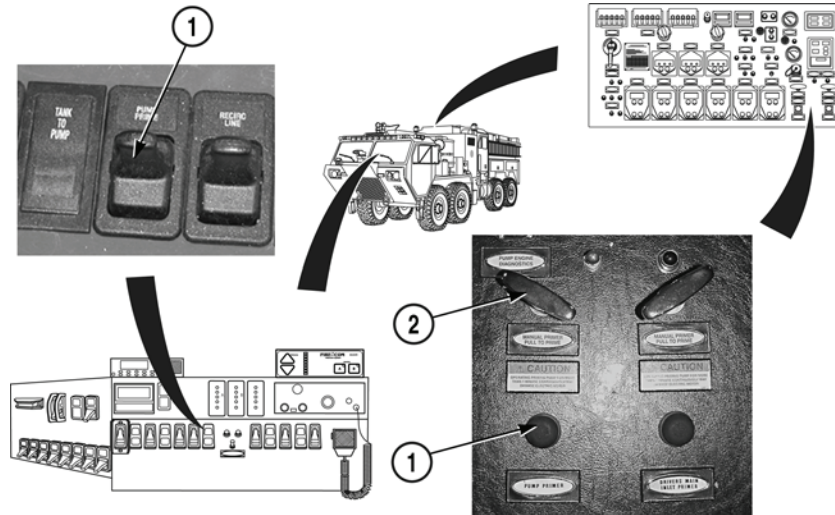

1. Ensure water pump engine is running (WP 0022).
2. Push PUMP PRIMER switch (1) to prime pump.

**NOTE**

- Perform Step (3) if primer solenoid fails.
  - Water pump can only be manually primed from the pump operator's panel.
3. Pull MANUAL PRIMER handle (2) and push PUMP PRIMER (1).

**⚠ CAUTION**

**Operating water pump engine at speeds of more than 1,200 RPM during priming is not recommended and will not improve priming operation. Failure to comply may result in damage to equipment.**

4. Using pressure governor, maintain water pump engine speed of 1,000 to 1,200 RPM (WP 0024).

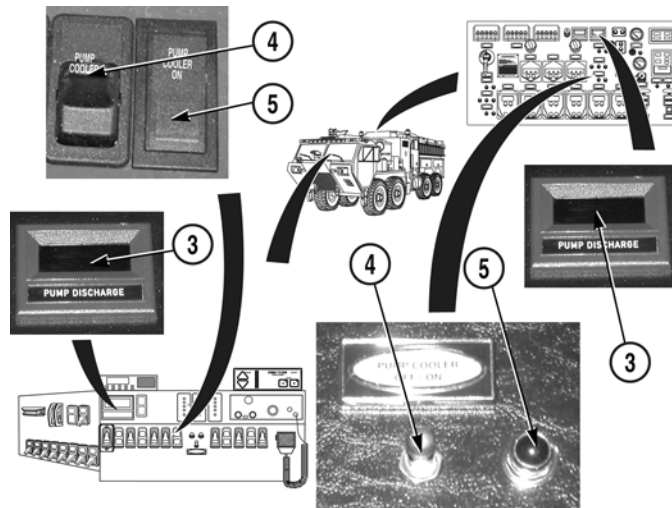

### **⚠ CAUTION**

If discharge gauge reading does not increase or priming pump does not discharge water on the ground in 60 seconds, do not continue running priming pump. Stop water pump or damage to equipment may result.

### **NOTE**

If water pump fails to prime, check hose connections, valve positions, strainers, and other water intake equipment for leaks that may be allowing air to enter system.

5. Observe readings on PUMP DISCHARGE (3) gauge. When water pump is primed, discharge pressure starts to increase. The operator may also hear water discharging on ground, indicating water pump is primed.

### **NOTE**

System is properly primed when pressure on pump discharge gauge remains steady.

6. Put PUMP COOLER switch (4) to ON position, let run 10 seconds. Indicator light (5) will illuminate.
7. Put PUMP COOLER switch (4) to OFF position. Indicator light (5) will go out.

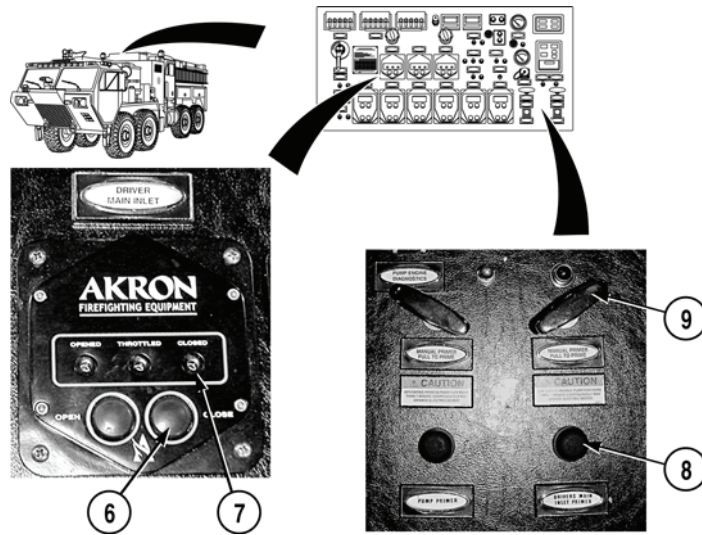

### NOTE

- Perform Steps (8) and (9) if/when driver's main inlet needs to be primed.
- Priming the driver's main inlet allows pumping operation to continue uninterrupted by pumping water from a draft when original pumping operations started from onboard water tank.
- Valve is completely closed when red indicator light illuminates.

8. Push DRIVER MAIN INLET valve control CLOSE button (6) until red indicator light (7) illuminates.
9. Push DRIVER MAIN INLET PRIMER switch (8) to prime driver main inlet.

### NOTE

Perform Step (10) if driver's main inlet primer solenoid fails.

10. Pull MANUAL PRIMER handle (9) and push DRIVER MAIN INLET PRIMER switch (8).

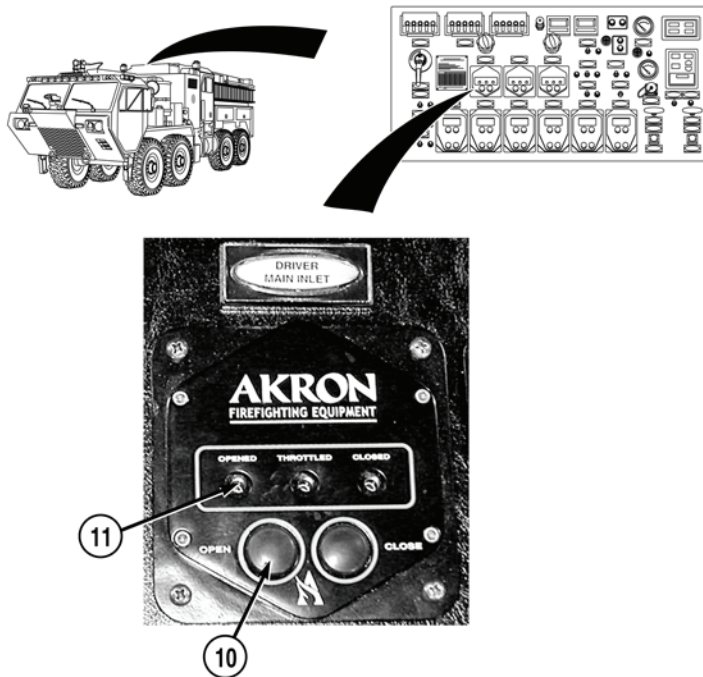

### NOTE

- If driver's main inlet fails to prime, check hose connections, valve positions, strainers, and other water intake equipment for leaks that may be allowing air to enter system.
- Valve is completely open when green indicator light illuminates.
- Perform Step (11) when driver's main inlet is primed.

11. Push DRIVER MAIN INLET valve control OPEN button (10) until green indicator light (11) illuminates.

**END OF TASK**

**END OF WORK PACKAGE**

---

**OPERATOR MAINTENANCE**  
**PRESSURE GOVERNOR OPERATION**

---

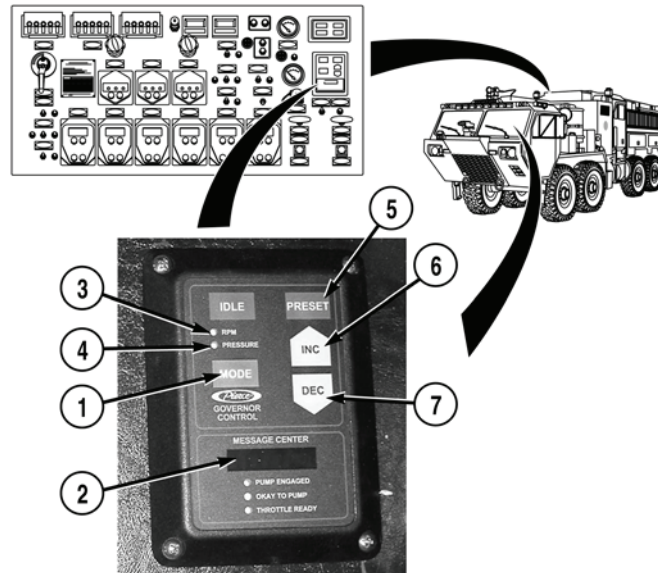
**NOTE**

PRESSURE GOVERNOR will check for valid pressure transducer signal at power up.

1. Push MODE switch (1) on desired pressure governor instrument panel.
2. MESSAGE CENTER (2) should display MODE.

**NOTE**

Pressure (psi) is the default mode of operation.

3. If desired, push MODE switch (1) to change to RPM mode. Indicator light (3) will illuminate. Press MODE switch (1) again to return to PRESSURE mode. Indicator light (4) will illuminate.

**NOTE**

PRESET switches are set individually for each control panel and only operate in PRESSURE mode.

4. Push PRESET switch (5) to set PRESSURE GOVERNOR to programmed pressure.

**NOTE**

When DEC switch is pressed, Decrease is displayed in the MESSAGE CENTER. When INC is pressed, Increase is displayed in the MESSAGE CENTER.

5. Push INC (6) or DEC (7) to adjust engine speed (RPM) or pressure.

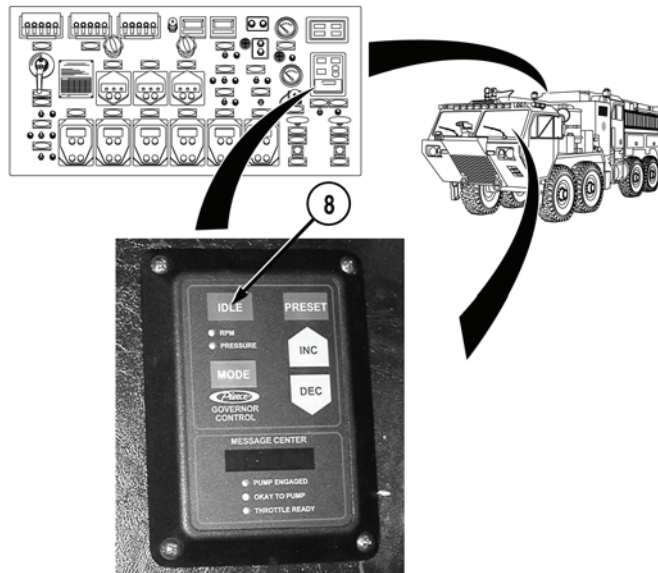

### NOTE

- If discharge pressure drops below 30 psi (207 kPa) for more than 5 seconds, pressure governor will return water pump engine to idle.
- Pressure governor must be returned to idle to allow operation from opposite pressure governor.

6. Push IDLE switch (8) to return water pump engine to normal idle and reset pressure governor circuit.

**END OF TASK**

**END OF WORK PACKAGE**



---

**OPERATOR MAINTENANCE**  
**PUMPING FROM DRAFT (MAIN INLET)**

---

**WARNING**



**When backing up vehicle, one crew member must be in back of vehicle operating rear step buzzer to communicate with operator. Failure to comply may result in damage to equipment or injury or death to personnel.**

**NOTE**

- Performance is maximized with less than a 10 ft. (3 m) vertical lift. As vertical lift increases above 10 ft. (3 m), maximum pump capacity will be reduced. Altitude also affects pump performance.
  - All valves, drains, and caps should be closed.
1. Position vehicle as close to water source as possible.
  2. Park vehicle (TM 9-2320-347-10).

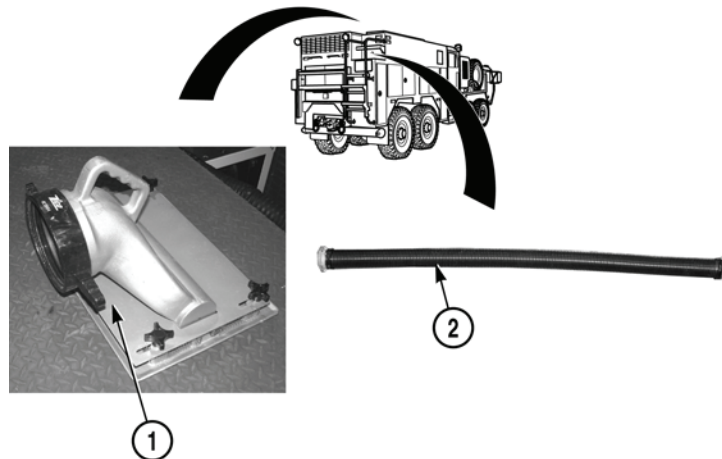

**CAUTION**

**Make sure suction hose strainer is clean and free from debris and obstructions. Failure to comply may result in damage to equipment.**

3. Connect suction hose strainer (1) to hard suction hose (2).

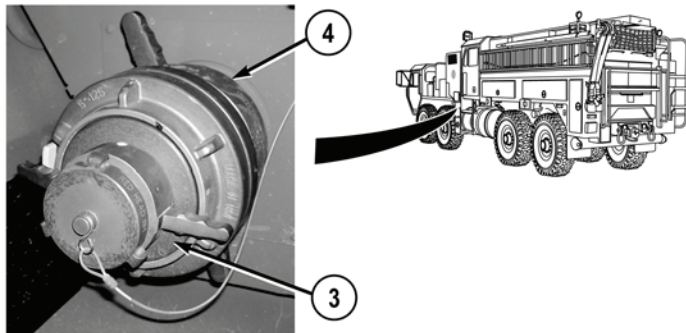

4. Remove cap (3) from DRIVER MAIN INLET (4).

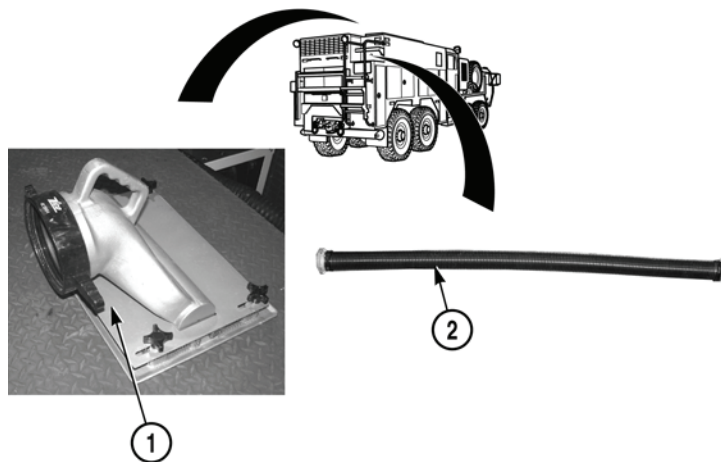

5. Connect suction hose (2) to DRIVER MAIN INLET (4).

**WARNING**



**Strainer must be positioned or suspended in water to prevent sucking of debris (sand, stones, mud, etc.). Strainer must be deep enough not to cause a whirlpool on surface of water. Failure to comply may result in injury or death to personnel and damage to equipment.**

6. Position suction hose strainer (1) in water source.

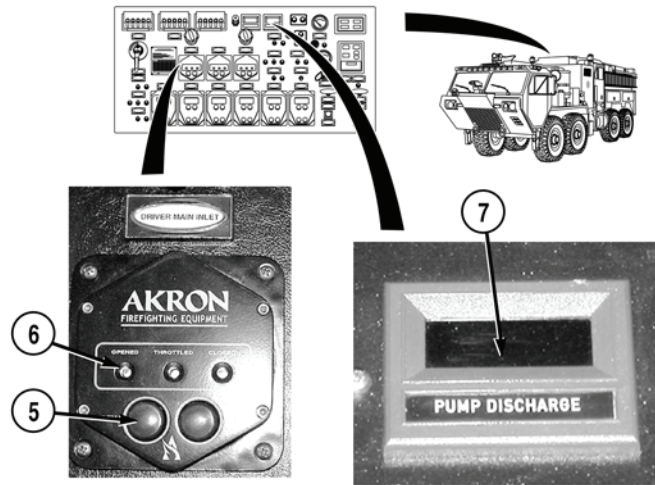

### **WARNING**



**Open and close all valves slowly during any procedure. Sudden changes in pressure may cause equipment to react faster than personnel can be alerted. Ensure surrounding personnel are aware of changes being made to settings on equipment. Failure to comply may result in injury or death to personnel and damage to equipment.**

### **NOTE**

Valve is completely open when green indicator light illuminates.

7. Push DRIVER SIDE MAIN INLET valve control OPEN button (5) until green indicator light (6) illuminates.
8. Start water pump engine (WP 0022).
9. Prime water pump (WP 0023) until pressure registers on PUMP DISCHARGE gauge (7).
10. Set pressure governor (WP 0024).

**WARNING**

- Discharge caps should not be removed if water system is under pressure. Discharge caps can act as projectiles if released under pressure, causing injury or death to personnel.
- If any discharge hose is used, make sure hose is removed from hose bed, nozzle is securely attached, and nozzle is turned off before opening any discharge valves. Failure to comply may result in injury to personnel.
- Open and close all valves slowly during any procedure. Sudden changes in pressure may cause equipment to react faster than personnel can be alerted. Ensure surrounding personnel are aware of changes being made to settings on equipment. Failure to comply may result in injury or death to personnel and damage to equipment.

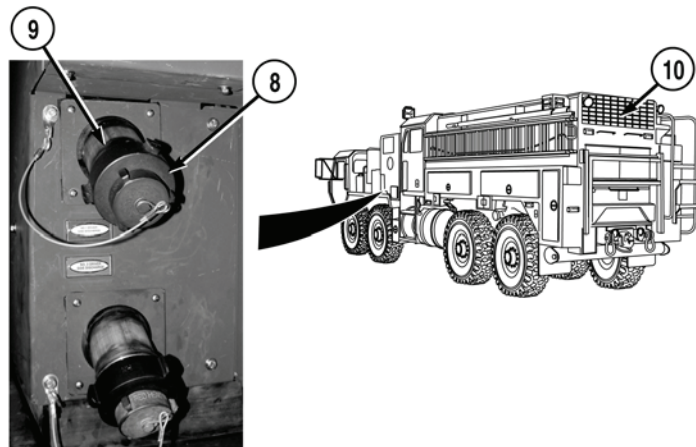
**CAUTION**

Cavitation can occur when pumping and air enters water. If engine speed increases without an increase in pressure, pump may be cavitating. Even though pump may be primed, air leaks can cause rough operation and an increase in engine speed without an increase in pressure or flow. If an air leak is suspected, discontinue pumping and isolate problem. Cavitation can also occur with large nozzle tips. Solve this problem by reducing flow. Failure to comply may result in damage to water pump.

**NOTE**

All discharges and pre-connects are operated the same way. NO. 1 DRIVER SIDE DISCHARGE shown.

11. Remove cap (8) from NO. 1 DRIVER SIDE DISCHARGE (9).
12. Connect discharge hose (10) to NO. 1 DRIVER SIDE DISCHARGE (9).

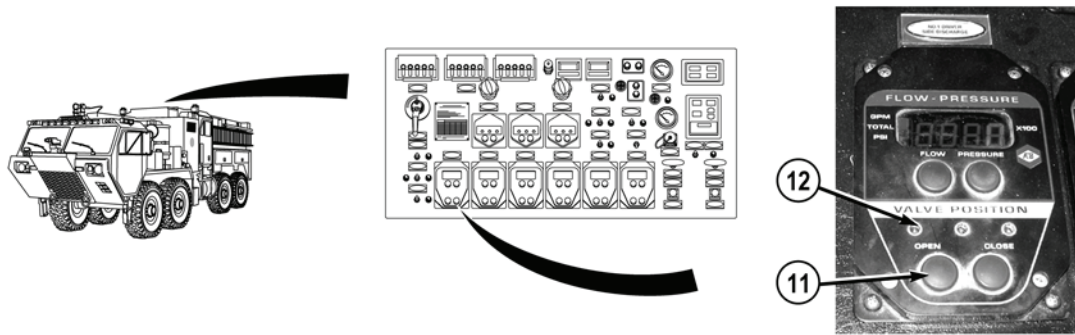

### NOTE

Valve is completely open when green indicator light illuminates.

13. Push NO. 1 DRIVER SIDE DISCHARGE valve control OPEN button (11) until green indicator light (12) illuminates.
14. Open other discharge valves to desired setting.

### CAUTION

**Do not pump (draft) enough water to cause a whirlpool at strainer. This allows air into pump resulting in cavitation, rough operation, pulsation and overheating. Reposition strainer or reduce flow to correct situation.**

15. Using pressure governor, increase engine RPM until desired pressure or flow is reached (WP 0024).
16. Complete mission.
17. Shut off water pump engine (WP 0022).
18. Perform post operation procedures (WP 0041).

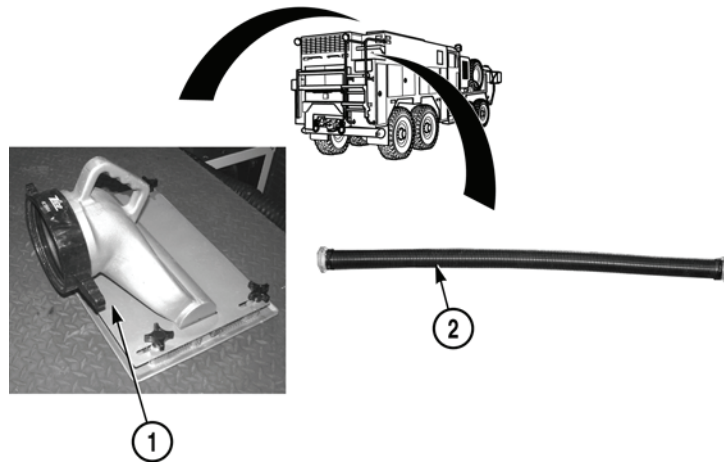

19. Remove suction hose strainer (1) from water source.
20. Disconnect suction hose (2) from DRIVER MAIN INLET (4).

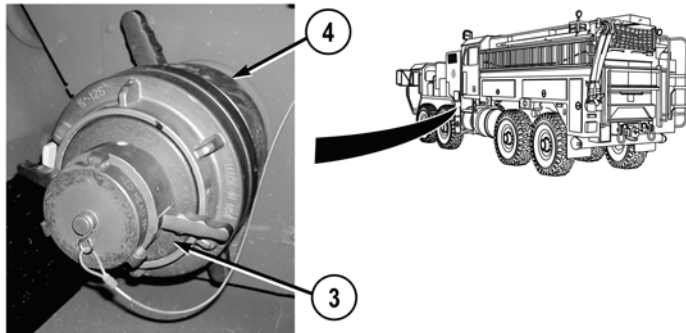

21. Install cap (3) on DRIVER MAIN INLET (4).
22. Disconnect suction hose strainer (1) from hard suction hose (2).

**END OF TASK**

**END OF WORK PACKAGE**

---

**OPERATOR MAINTENANCE**  
**PUMPING FROM ONBOARD WATER TANK**

---

**WARNING**

**When backing up vehicle, one crew member must be in back of vehicle operating rear step buzzer to communicate with operator. Failure to comply may result in damage to equipment or injury or death to personnel.**

**NOTE**

All valves, drains, and caps should be closed.

1. Position vehicle for convenient discharge hose layout and bring vehicle to complete stop.
2. Park vehicle (TM 9-2320-347-10).
3. Start water pump engine (WP 0022).

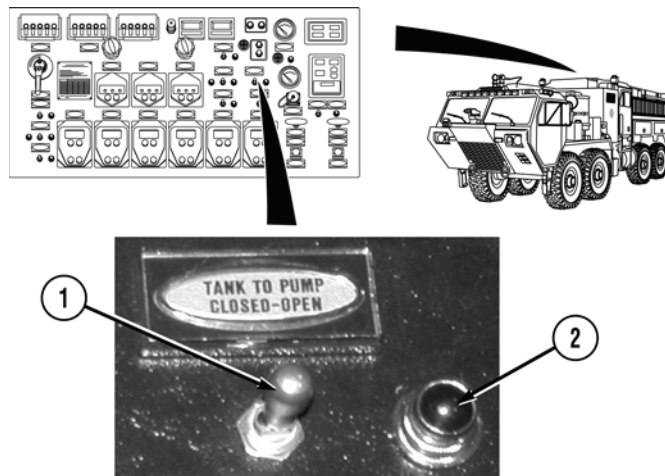

4. Put TANK TO PUMP switch (1) to OPEN position. Indicator light (2) will illuminate.
5. Prime water pump (WP 0023).

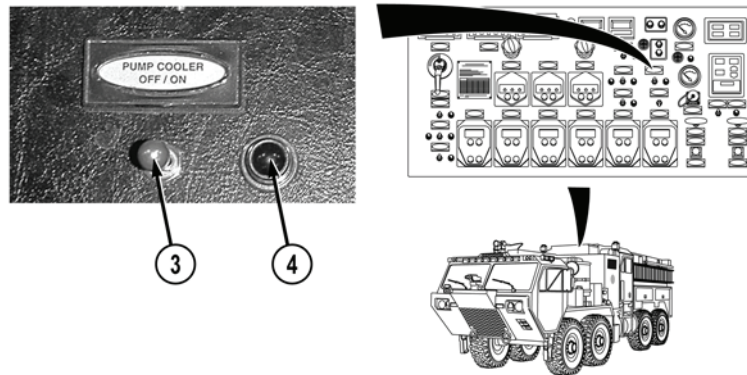

6. Put PUMP COOLER switch (3) to ON position indicator (4) will illuminate.

### **WARNING**



- Discharge caps should not be removed if water system is under pressure. Discharge caps can act as projectiles if released under pressure causing injury or death to personnel.
- Open and close all valves slowly during any procedure. Sudden changes in pressure may cause equipment to react faster than personnel can be alerted. Ensure surrounding personnel are aware of changes being made to settings on equipment. Failure to comply may result in injury or death to personnel and damage to equipment.
- If any discharge hose is used, make sure hose is removed from hose bed, nozzle is securely attached, and nozzle is turned off before opening any discharge valves. Failure to comply may result in injury to personnel.

### **CAUTION**

Cavitation can occur when pumping and air enters water. If engine speed increases without an increase in pressure, pump may be cavitating. Even though pump may be primed, air leaks can cause rough operation and an increase in engine speed without an increase in pressure or flow. If an air leak is suspected, discontinue pumping and isolate problem. Cavitation can also occur with large nozzle tips. Solve this problem by reducing flow. Failure to comply may result in damage to water pump.



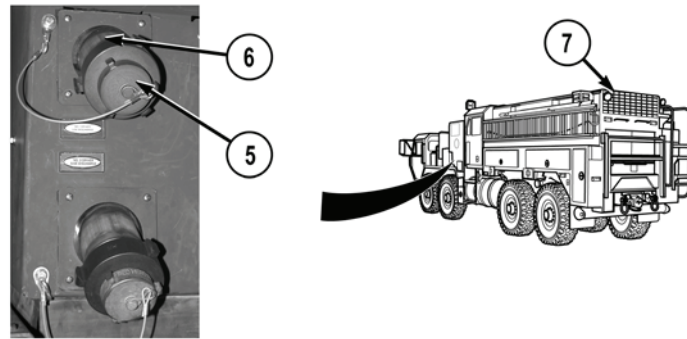

### NOTE

All discharges and pre-connects are operated the same way. NO. 1 DRIVER SIDE DISCHARGE shown.

7. Remove cap (5) from NO. 1 DRIVER SIDE DISCHARGE (6).
8. Connect discharge hose (7) to NO. 1 DRIVER SIDE DISCHARGE (6).
9. Set pressure governor (WP 0024).

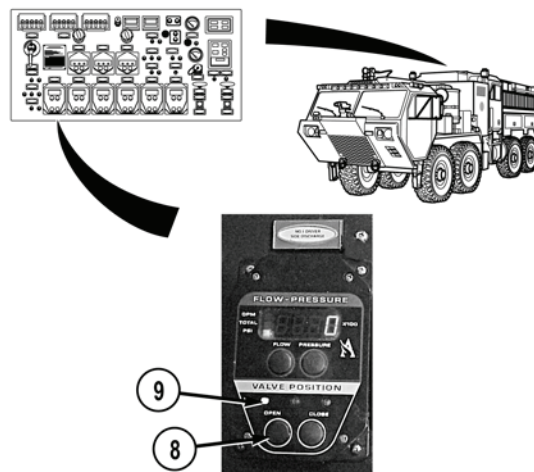

10. Push NO.1 DRIVER SIDE DISCHARGE valve control OPEN button (8) until desired pressure is achieved. Green indicator light (9) will illuminate.
11. Open other discharge valves to desired setting.

### NOTE

Perform Steps (12) through (16) if performing direct tank fill.

12. Connect hose from positive water source to direct tank fill inlets as required.
13. Open supply valve on positive water source.

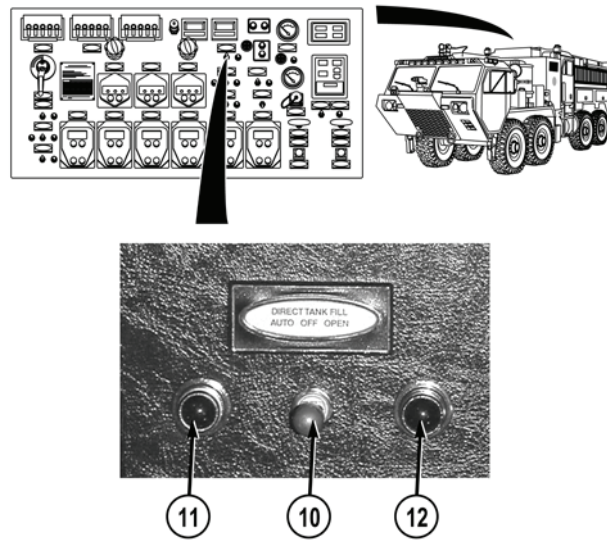

14. Put DIRECT TANK FILL switch (10) to AUTO position. Indicator lights (11) and (12) will illuminate.
15. Complete mission.
16. Shut off water pump engine (WP 0022).

#### NOTE

Perform Steps (17) through (21) if direct tank fill was performed.

17. Shut off positive water source valve.
18. Put DIRECT TANK FILL switch (10) to OPEN position. Indicator light (11) will go out.
19. Relieve pressure in hose, if necessary, put DIRECT TANK FILL switch (10) to OFF position. Indicator light (12) will go out.
20. Remove hose from positive water source and direct tank fill inlets as required.
21. Perform post operation procedures (WP 0041).

**END OF TASK**

**END OF WORK PACKAGE**

---

**OPERATOR MAINTENANCE**
**PUMPING FROM HYDRANT OR IN RELAY (POSITIVE WATER SOURCES)**

---

**NOTE**

- Make sure valves, drains, and caps are closed.
  - Foam system will not operate when pump intake pressure is more than 5 psi (34 kPa).
  - Main Inlet may be operated with either 5 in. (13cm) or 3 in. (7.6 cm) suction hose.
  - 5 in. (13 cm) and 3 in. (7.6 cm) suction hoses operate the same way. 5 in. (13 cm) suction hose shown.
1. Position vehicle for convenient hydrant hookup and discharge hose layout. Bring vehicle to complete stop.
  2. Park vehicle (TM 9-2320-347-10).

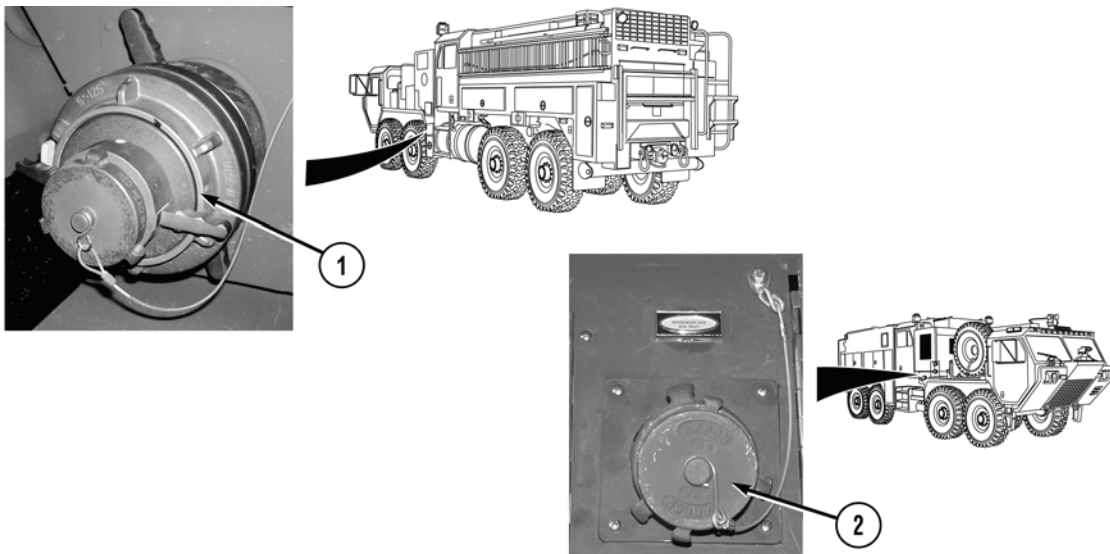
**NOTE**

Pumping may be performed from either main inlet or PASSENGER SIDE AUX. INLET.

3. Remove cap from either main inlet (1) or PASSENGER SIDE AUX. INLET (2).

**WARNING**

**Do not use hard suction hose for Step (4). Hard suction hose will not hold pressure. Hose may fail and separate causing injury to personnel and/or damage to equipment.**

4. Connect either 5 in. (13 cm) soft suction hose to main inlet (1) or 3 in. (8 cm) discharge hose to PASSENGER SIDE AUX. INLET (2).

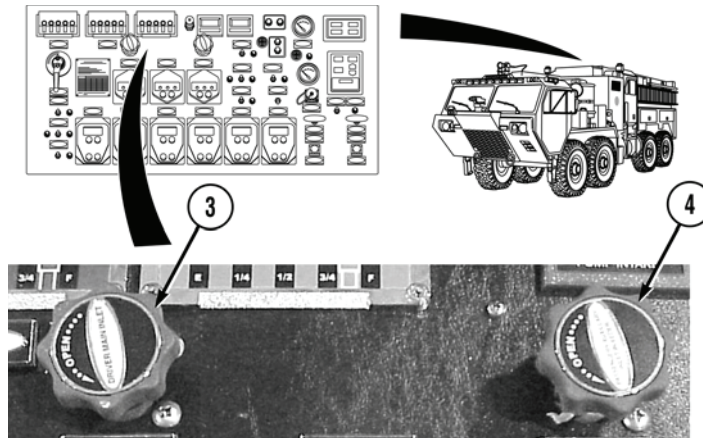

### **WARNING**



**Open and close all valves slowly during any procedure. Sudden changes in pressure may cause equipment to react faster than personnel can be alerted. Ensure surrounding personnel are aware of changes being made to settings on equipment. Failure to comply may result in injury or death to personnel and damage to equipment.**

5. Open supply valve on positive water source.
6. Open DRIVER MAIN INLET bleeder valve (3) or PASSENGER SIDE AUX. INLET bleeder valve (4) until water discharges to ground.
7. Close DRIVER MAIN INLET bleeder valve (3) or PASSENGER SIDE AUX. INLET bleeder valve (4).

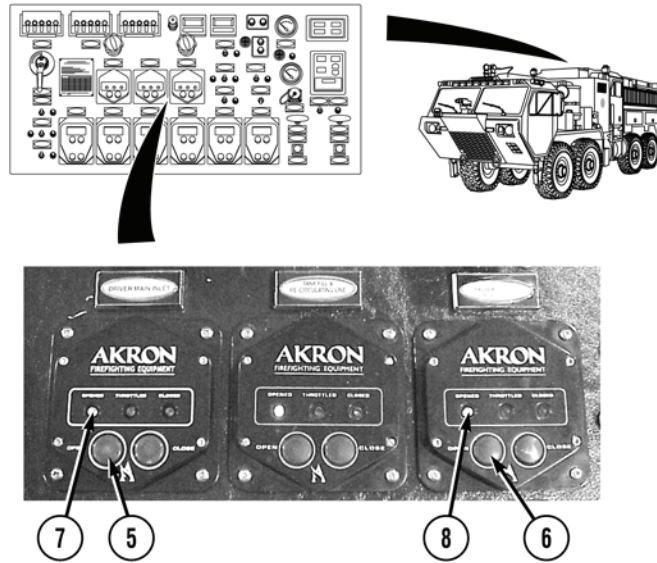

### NOTE

Valve is completely open when green indicator light illuminates.

8. Push DRIVER MAIN INLET valve control OPEN button (5) or PASSENGER SIDE AUX. INLET valve control OPEN button (6) until green indicator light (7) or (8) illuminates.

### NOTE

If water source pressure exceeds 125 psi (862 kPa), intake relief valves will discharge water to ground.

9. Start water pump engine (WP 0022).
10. Prime main water pump (WP 0023).
11. Set pressure governor (WP 0024).

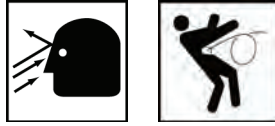
**WARNING**

- Discharge caps should not be removed if water system is under pressure. Discharge caps can act as projectiles if released under pressure causing injury or death to personnel.
- If any discharge hose is used, make sure hose is removed from hose bed, nozzle is securely attached, and nozzle is turned off before opening any discharge valves. Failure to comply may result in injury to personnel.
- Open and close all valves slowly during any procedure. Sudden changes in pressure may cause equipment to react faster than personnel can be alerted. Ensure surrounding personnel are aware of changes being made to settings on equipment. Failure to comply may result in injury or death to personnel and damage to equipment.

**CAUTION**

Cavitation can occur when pumping and air enters water. If engine speed increases without an increase in pressure, pump may be cavitating. Even though pump may be primed, air leaks can cause rough operation and an increase in engine speed without an increase in pressure or flow. If an air leak is suspected, discontinue pumping and isolate problem. Cavitation can also occur with large nozzle tips. Solve this problem by reducing flow. Failure to comply may result in damage to water pump.

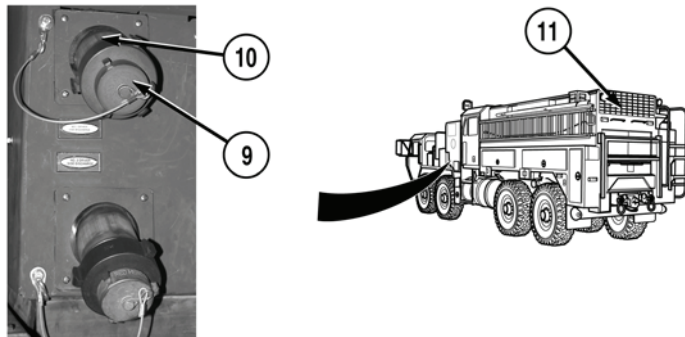

12. Remove cap (9) from NO.1 DRIVER SIDE DISCHARGE (10).
13. Connect discharge hose (11) to NO. 1 DRIVER SIDE DISCHARGE (10).

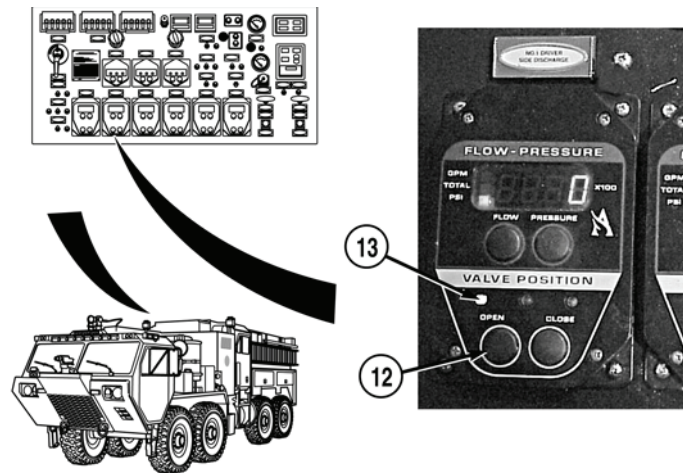

**NOTE**

Valve is completely open when green indicator light illuminates.

14. Push NO. 1 DRIVER SIDE DISCHARGE valve control OPEN button (12) until green indicator light (13) illuminates.
15. Open other discharge valves to desired setting.
16. Complete mission.
17. Shut off water pump engine (WP 0022).

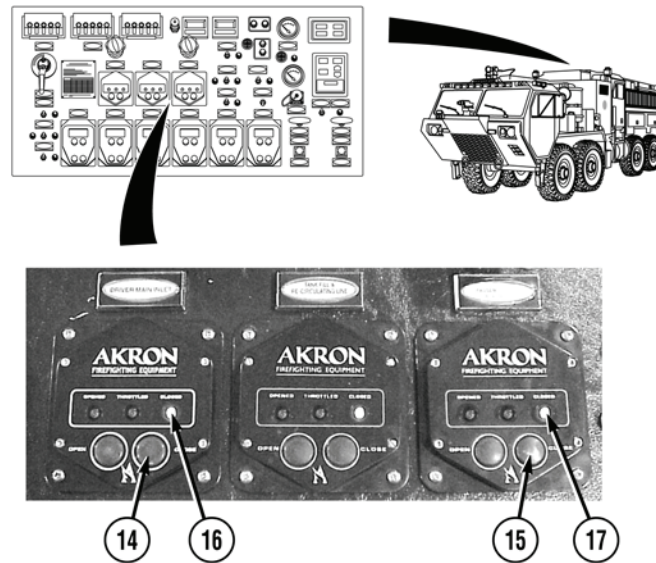

**NOTE**

Valve is completely closed when red indicator light illuminates.

18. Push DRIVER MAIN INLET valve control CLOSE button (14) or PASSENGER SIDE AUX. INLET valve control CLOSE button (15) until red indicator light (16) or (17) illuminates.
19. Close supply valve on water source.

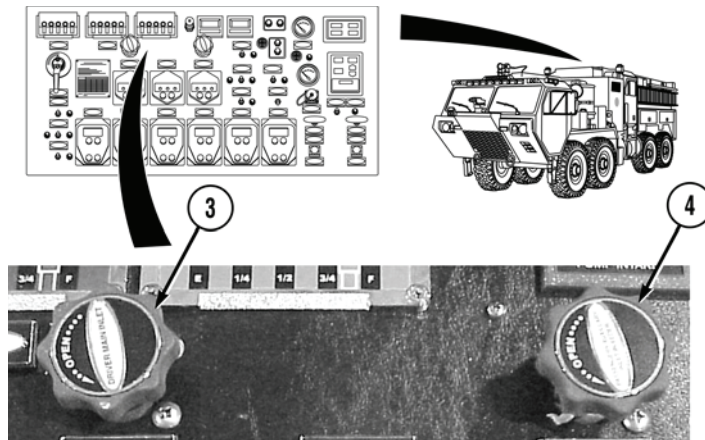

20. Open DRIVER MAIN INLET bleeder valve (3) or PASSENGER SIDE AUX. INLET bleeder valve (4).
21. Relieve pressure in hose.

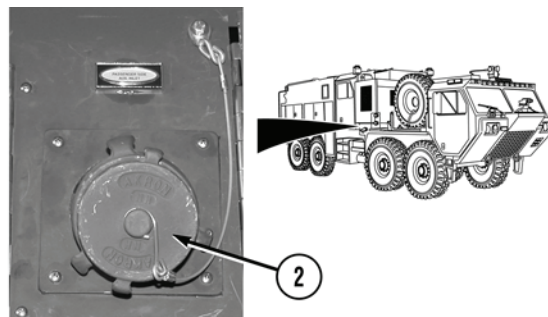
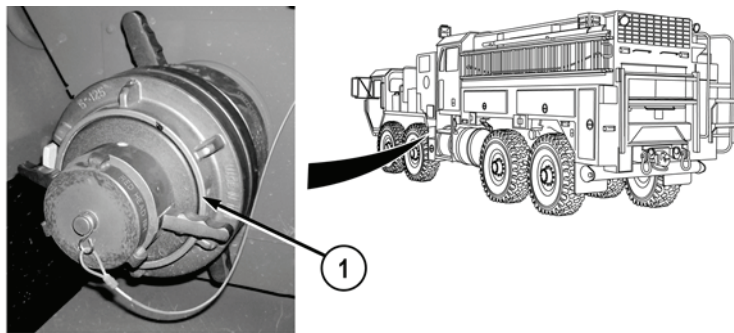

22. Disconnect either 5 in. (13 cm) soft suction hose from DRIVER MAIN INLET (1) or 3 in. (7.6 cm) discharge hose from PASSENGER SIDE AUXILIARY INLET (2).
23. Perform post operation procedures (WP 0041).

**END OF TASK**

**END OF WORK PACKAGE**



---

**OPERATOR MAINTENANCE**  
**PUMP AND ROLL PROCEDURES**

---

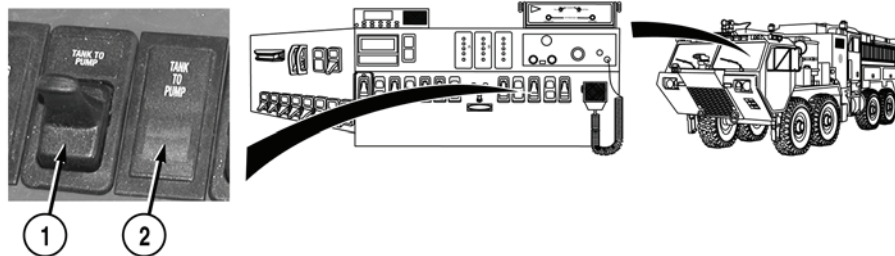

**WARNING**



- **Open and close all valves slowly during any procedure. Sudden changes in pressure may cause equipment to react faster than personnel can be alerted. Ensure surrounding personnel are aware of changes being made to settings on equipment. Failure to comply may result in injury or death to personnel and damage to equipment.**
- **Pump and roll procedures must be performed from vehicle cab. Do not use pump operator's panel for pump and roll procedures. Failure to comply may result in injury or death to personnel.**
- **Due to poor driver visibility to curb side of vehicle over doghouse and cab mounted equipment, a crew member must be seated in passenger seat when vehicle is in motion. Failure to comply may result in damage to equipment or injury or death to personnel.**

**NOTE**

For maximum bumper turret and roof turret performance, maintain 200 to 210 psi (1,379 to 1,448 kPa) on pump discharge gauge.

1. Make sure crew cab roof hatch is closed and secured (WP 0018).
2. Put TANK TO PUMP switch (1) to ON position. Indicator light (2) will illuminate.
3. Start water pump engine (WP 0022).
4. Prime water pump (WP 0023) until pressure registers on pump discharge gauge.
5. For foam operations, refer to (WP 0034).
6. Set pressure governor (WP 0024).

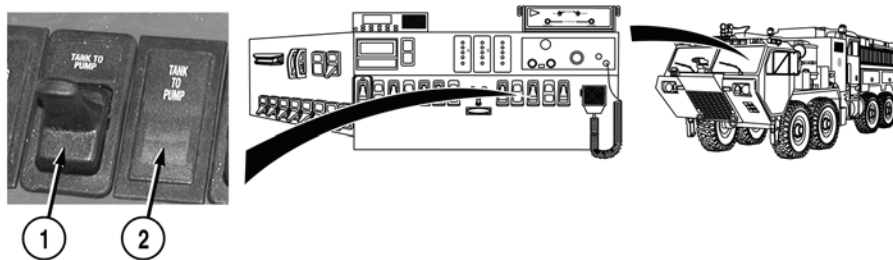

7. Select desired discharge:
  - a. Bumper turret (WP 0035).
  - b. Roof turret (WP 0036).
  - c. Windshield deluge (WP 0038).
  - d. Ground Sweeps (WP 0039).

** CAUTION**

**Monitor water level gauge during mission. Damage to water pump will occur if water tank runs out of water.**

8. Monitor water level gauge during mission.
9. Complete mission.
10. Put TANK To PUMP switch (1) to off position. Indicator light (2) will go out.
11. Shut off water pump engine (WP 0022).
12. Perform post operation procedures (WP 0041).

**END OF TASK**

**END OF WORK PACKAGE**

---

**OPERATOR MAINTENANCE****DRAINING WATER TANK**

---

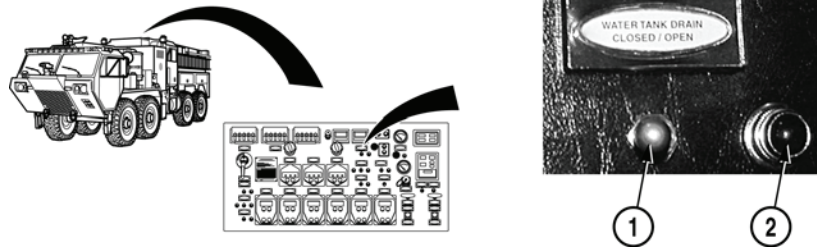
**WARNING**

**Temperature must be above freezing if draining water tank while on a driving surface. Water could freeze on driving surface. Failure to comply may result in damage to equipment and/or injury or death to personnel.**

1. Position vehicle in a suitable location to drain water tank.
2. Put WATER TANK DRAIN switch (1) to OPEN position. Indicator light (2) will illuminate.
3. Allow water tank to drain.
4. Put WATER TANK DRAIN switch (1) to CLOSED position. Indicator light (2) will go out.

**END OF TASK****END OF WORK PACKAGE**



---

**OPERATOR MAINTENANCE**

**FOAM SYSTEM GENERAL INFORMATION**

---

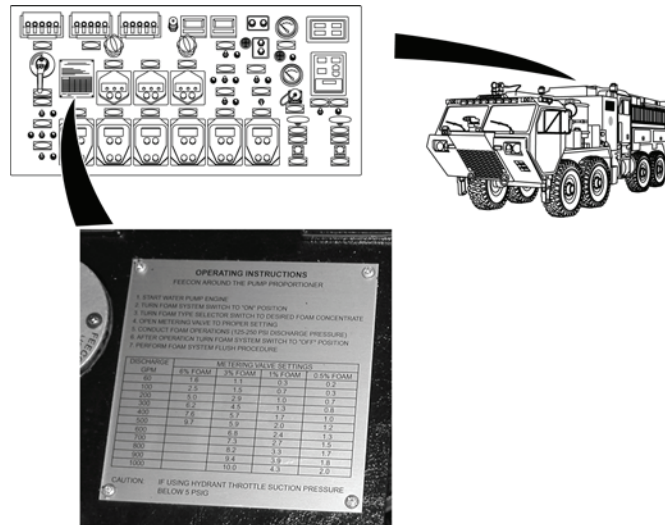

**⚠ CAUTION**

- **Do not mix different types or brands of foam agent in foam tanks or piping. Mixing of different foam agents (either type or manufacturer) may cause deterioration of foam agent, improper proportioning and poor performance in a fire situation. Mixing of Class A and Class B foam agents may result in a chemical reaction which can create globules, which can clog orifices and cause system failure.**
  - **When in foam mode never open TANK FILL & RE-CIRCULATING LINE valve. This will cause foam agent to enter water tank. If re-circulation is needed to keep pump cool, open PUMP COOLER valve.**
1. Foam system operation from cab (turret operation) requires system pressure of at least 200 to 210 psi (1,379 to 1,448 kPa) for proper proportion.
  2. Foam system operation from pump operator's panel requires system pressure of at least 125 to 250 psi (862 to 1,724 kPa) for proper proportion.

**END OF WORK PACKAGE**



---

**OPERATOR MAINTENANCE**  
**FOAM AGENT FILLING/DRAINING/FLUSHING**

---

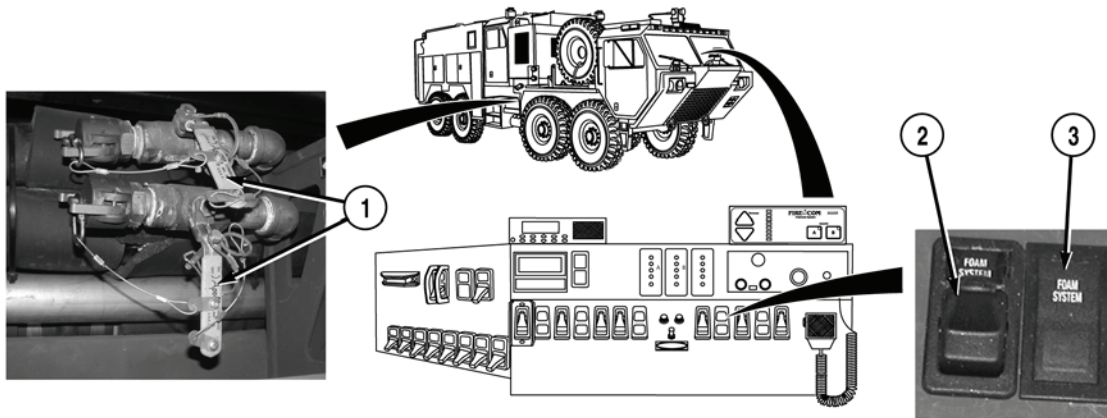
**FILLING FOAM AGENT TANK**

**⚠ CAUTION**

- **Do not mix different types or brands of foam agent in foam cells or piping. Mixing of different foam agents (either type or manufacturer) may cause deterioration of foam agent, improper proportioning and poor performance in a fire situation. Mixing of Class A and Class B foam agents may result in a chemical reaction which can create globules, which can clog orifices and cause system failure.**
- **Do not spill foam agent on pressure/vacuum vents. Clean any spilled foam agent before continuing with procedures. If vents become blocked, pressure could build up in tanks and may cause damage to equipment.**

When filling foam agent tank during a non-fire situation, following procedure is recommended:

1. Vehicle should be parked on a level surface.
2. Make sure all water and other contaminants have been drained from foam tanks before filling.
3. Make sure FOAM TANK DRAIN valves (1) are in CLOSED position.
4. Make sure FOAM SYSTEM switch (2) is in OFF position. Indicator light (3) will be out.
5. Unstow passenger side rear access ladder (WP 0013).

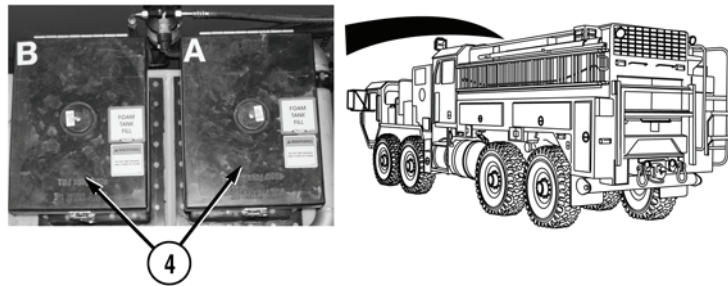
**WARNING**

**Use extreme care when walking on hose bed cover and on top of vehicle. Be extra careful in wet, icy, or muddy conditions. Failure to comply may result in personnel slipping and falling causing injury or death to personnel.**

6. Open expansion dome hatches (4).

**WARNING**

**Caution must be taken when carrying 5 gal. (19 l) pails of foam agent to top of foam agent tank. If foam agent is spilled, walking surface can become extremely slippery. Clean any spilled foam agent before continuing to fill foam agent tank. Failure to comply may result in injury or death to personnel.**

**NOTE**

Foam cell should be filled halfway up into expansion dome to minimize surface area of foam agent subject to evaporation. Pour foam agent down center of round tube when filling tank. This tube goes to bottom of tank and allows foam agent to enter under surface of foam currently in tank. This is done to reduce aeration of foam agent per NFPA.

7. Foam agent must be added by pouring through the 4 in. (10 cm) tube; it must be done slowly and carefully to prevent aeration. If aeration occurs inside tank, stop pouring until foam agent bubbles dissolve. Take care not to allow water, dirt, debris, or foreign substance to enter tank.
8. Close expansion dome hatches (4).
9. Stow right rear access ladder (WP 0013).

**END OF TASK**



**DRAINING/FLUSHING FOAM AGENT TANK****NOTE**

- Foam drained from foam tanks will need to be drained into properly marked and sealed containers.
- Both foam tanks are drained and flushed the same way. Foam tank B shown.

1. Gather suitable containers.
2. Attach drain hose (1) to FOAM TANK DRAIN valve (2).
3. Open expansion dome hatch (3).
4. Put FOAM TANK DRAIN valve handle (4) in open position and completely drain foam into containers.
5. Put FOAM TANK DRAIN valve handle (4) in closed position.
6. Properly label sealed containers when foam is completely drained from foam tank (5).

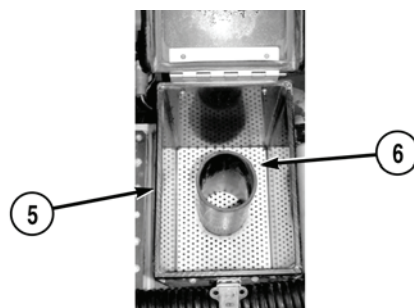

7. Remove fill tower screen (6) from foam tank (5).

**NOTE**

Defoaming agent and water must be added to foam tank being flushed.

8. Add defoaming agent to foam tank (5).
9. Fill foam tank (5) with warm water.

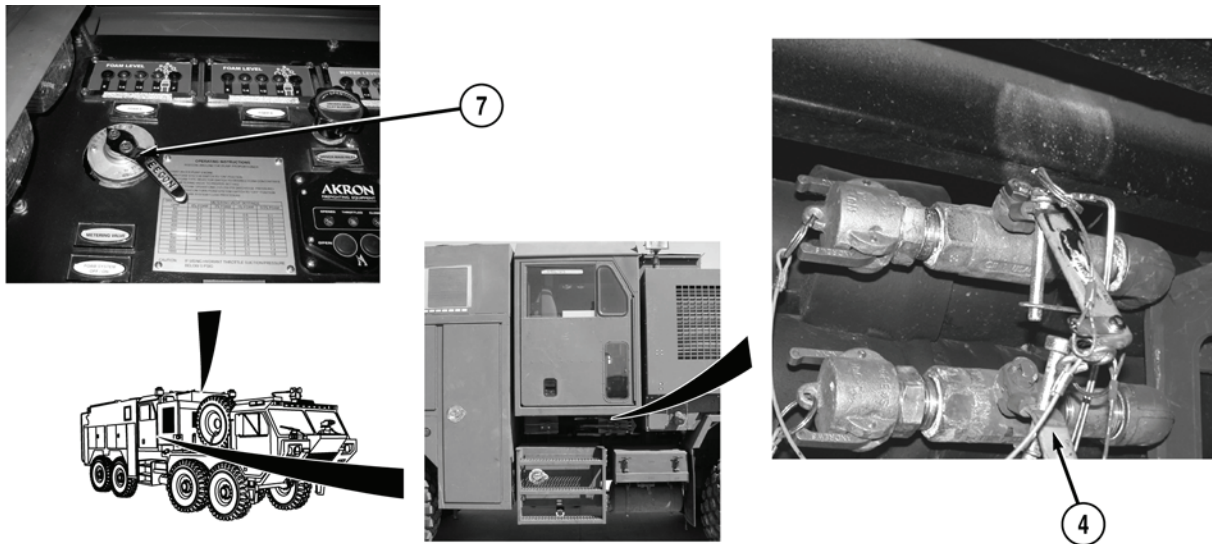

**NOTE**

Local draining laws must be followed when draining and flushing foam and water from foam tanks.

10. Put FOAM TANK DRAIN valve (4) in open position and drain water from foam tank (5).
11. Repeat Steps (6) through (10) until foam tank (5) is clean.
12. Put FOAM TANK DRAIN valve (4) in closed position.
13. Put foam METERING VALVE (7) in open position.
14. Run foam system with water instead of foam (WP 0033).
15. Discharge water until foam tank (5) is empty.
16. All debris must be removed from foam tank (5) after flushing in complete.

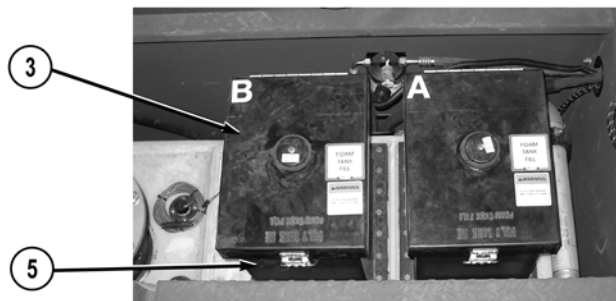

17. Close expansion dome (3).
18. Stow passenger side rear access ladder (WP 0013).

**END OF TASK**

**END OF WORK PACKAGE**

---

**OPERATOR MAINTENANCE****FOAM SYSTEM AND INSTRUMENT PANEL-STANDBY MODE**

---

**INSTRUMENT PANEL-STANDBY MODE****WARNING**

**Open and close all valves slowly during any procedure. Sudden changes in pressure may cause equipment to react faster than personnel can be alerted. Ensure surrounding personnel are aware of changes being made to settings on equipment. Failure to comply may result in injury or death to personnel and damage to equipment.**

**NOTE**

For operation of pump, most controls and procedures will be the same whether pumping from tank, draft, or hydrant.

Operator must make sure that:

1. ALL water discharge valve controls are in CLOSED position (WP 0004).
2. ALL water inlets are in CLOSED position (WP 0004).
3. ALL DRAINS are in CLOSED position (WP 0004).
4. ALL foam controls are in CLOSED/OFF position (WP 0004).
5. ALL inlet and outlet ports are capped (WP 0004).

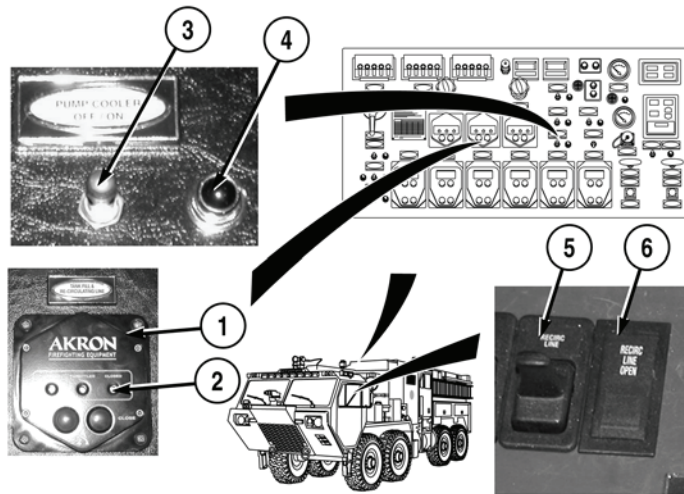

6. Make sure TANK FILL & RE-CIRCULATING LINE valve control (1) is in CLOSED position. Red indicator light (2) will illuminate.
7. Put pump operator's panel PUMP COOLER switch (3) to OFF position. Indicator light (4) will go out.
8. Put cab RECIRC LINE switch (5) to OFF position. Indicator light (6) will go out.

#### END OF TASK

#### FOAM SYSTEM-STANDBY MODE

#### WARNING



Open and close all valves slowly during any procedure. Sudden changes in pressure may cause equipment to react faster than personnel can be alerted. Ensure surrounding personnel are aware of changes being made to settings on equipment. Failure to comply may result in serious injury or death to personnel and damage to equipment.

#### CAUTION

Turn on foam system only when needed. Failure to comply may result in damage to equipment.

#### NOTE

When in foam mode, never open TANK FILL & RE-CIRCULATING LINE valve. This will cause foam agent to enter water tank. If recirculation is needed to keep pump cool, open PUMP COOLER valve.

Foam system is in Standby Mode when:

1. Drains are closed (WP 0004).

2. Foam tank vents are not blocked and clean.
3. No known leaks.
4. Foam tanks are full (WP 0031).
5. Latches are secured (WP 0031).

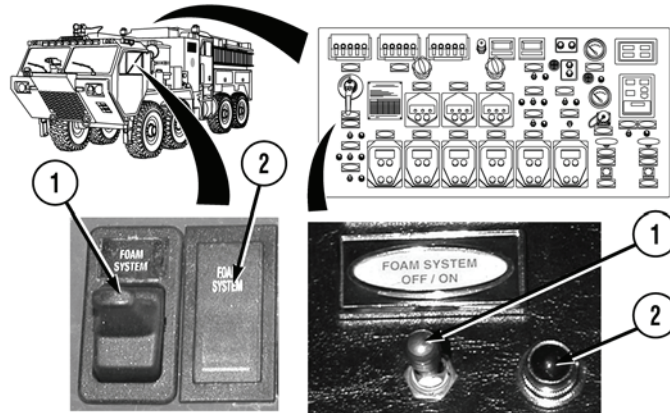

6. Put FOAM SYSTEM switch (1) to OFF position. Indicator light (2) will go out.

**END OF TASK**

**END OF WORK PACKAGE**



---

**OPERATOR MAINTENANCE****FOAM SYSTEM OPERATING PROCEDURES (PUMP OPERATOR'S PANEL)**

---

**FOAM SYSTEM ACTIVATION****WARNING**

- Before operating foam system, personnel must familiarize themselves with all procedures and instructions regarding water pump, discharge devices, and foam making devices. Failure to understand and follow any instructions could result in injury to personnel and/or damage to equipment.
- Open and close all valves slowly during any procedure. Sudden changes in pressure may cause equipment to react faster than personnel can be alerted. Ensure surrounding personnel are aware of changes being made to settings on equipment. Failure to comply may result in injury or death to personnel and damage to equipment.

**CAUTION**

When in foam mode, never open TANK FILL & RE-CIRCULATION LINE valve control. This will cause foam agent to enter water tank. If re-circulation is needed to keep pump cool, open PUMP COOLER valve.

Foam system operation from pump operator's panel requires system pressure of at least 125 to 250 psi (862 to 1,724 kPa) for proper proportion.

**END OF TASK**

## STARTING FOAM SOLUTION FLOW

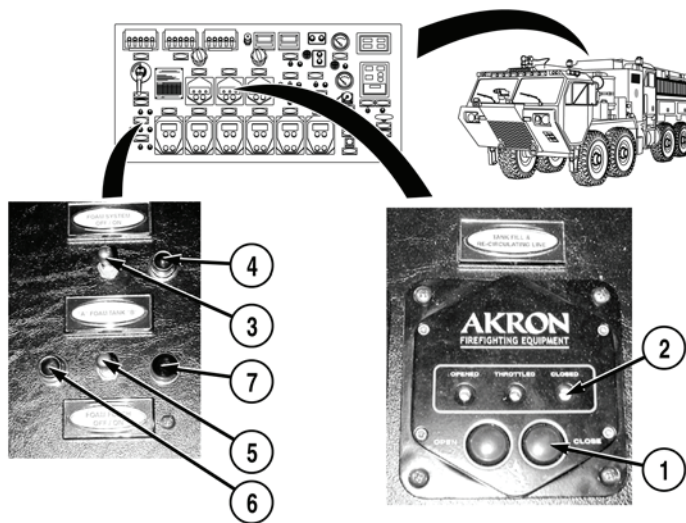

1. Start water pump engine (WP 0022).

**NOTE**

Valve is completely closed when red light illuminates.

2. Push TANK FILL & RE-CIRCULATION LINE valve CLOSE button (1) until red indicator light (2) illuminates.
3. Put FOAM SYSTEM switch (3) to ON position. Indicator light (4) will illuminate.
4. Put FOAM TANK selector switch (5) to desired foam agent. Indicator light A (6) or light B (7) will illuminate.
5. Make sure correct FOAM TANK selector indicator light A (6) or B (7) is illuminated.

**NOTE**

If operating from a hydrant source, check pump suction pressure. Intake pressure must be 5 psi (34 kPa) or less or proportioner will not function properly.

6. Establish water flow to desired discharge outlet(s) (WP 0025), (WP 0026), or (WP 0027).



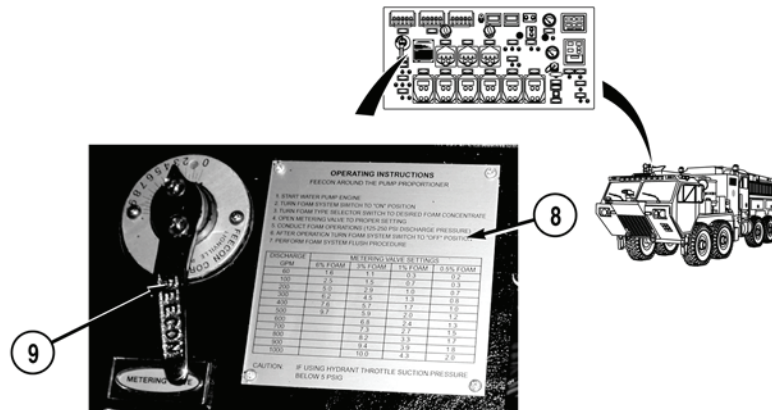

**CAUTION**

If water is stopped, metering valve must be closed to prevent foam agent from entering piping and water pump. Failure to comply may result in damage to equipment.

**NOTE**

- Instruction plate mounted on pump operator's panel gives settings versus flow rates for various agents.
- Each time the flow rate is changed, the METERING VALVE must be reset.
- The sum of the discharges need to be added together for total discharge GPM.

7. Using chart (8), determine flow rate and set METERING VALVE (9) to deliver proper percentage.

**END OF TASK**

**STOPPING FOAM SOLUTION FLOW**

Put METERING VALVE (9) in CLOSED position.

**END OF TASK**

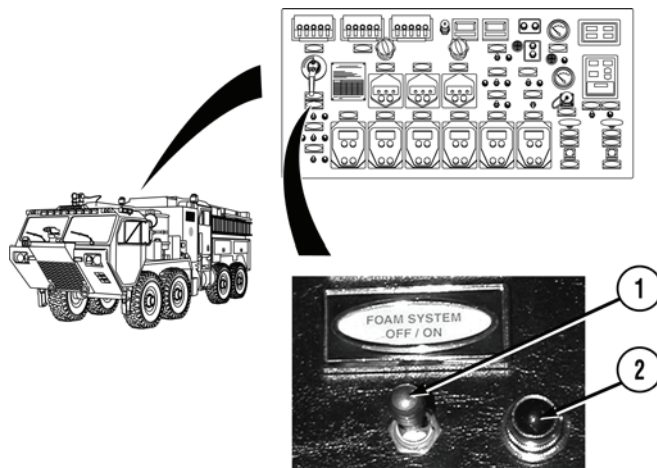
**FOAM SYSTEM DEACTIVATION/CLEAN-UP****NOTE**

When performing Step (1), FOAM TANK SUPPLY valve will automatically shut off.

1. Put FOAM SYSTEM switch (1) to OFF position. Indicator light (2) will go out.
2. Using pressure governor, decrease engine RPM to reduce water pressure (WP 0024).
3. Perform foam system flushing procedure (WP 0032).

**END OF TASK****END OF WORK PACKAGE**

## OPERATOR MAINTENANCE

## FOAM SYSTEM OPERATING PROCEDURES (CAB INSTRUMENT PANEL)

## FOAM SYSTEM ACTIVATION

**WARNING**

- Before operating foam system, personnel must familiarize themselves with all procedures and instructions regarding water pump, discharge devices and foam making devices. Failure to understand and follow any instructions could result in injury to personnel and/or damage to this equipment.
- Open and close all valves slowly during any procedure. Sudden changes in pressure may cause equipment to react faster than personnel can be alerted. Ensure surrounding personnel are aware of changes being made to settings on equipment. Failure to comply may result in injury or death to personnel and damage to equipment.

**NOTE**

When foam system is operated from personnel cab, foam solution is present at all discharges (roof turret, bumper turret, and ground sweeps) except windshield deluge.

1. Start water pump engine (WP 0022).

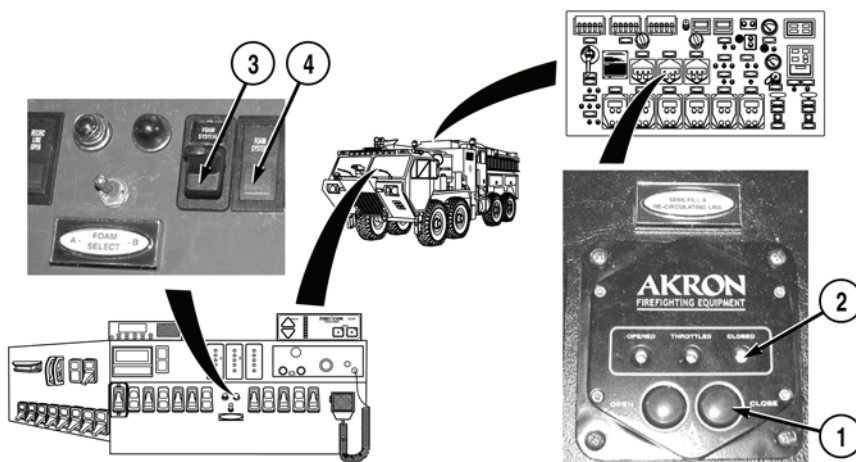
**NOTE**

Valve is completely closed when red indicator light illuminates.

2. Push TANK FILL & RE-CIRCULATING LINE valve control CLOSE button (1) until red indicator light (2) illuminates.
3. Put FOAM SYSTEM switch (3) to ON position. Indicator light (4) will illuminate.

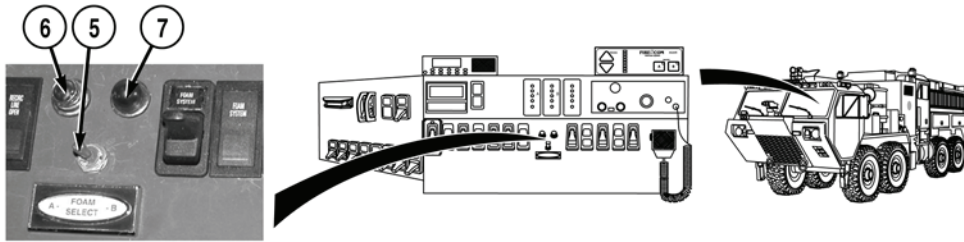

4. Put FOAM SELECT switch (5) to desired foam agent. Indicator light A (6) or light B (7) will illuminate.
5. Make sure correct foam indicator light A (6) or light B (7) is illuminated.
6. Establish water flow to desired discharge outlet(s) (WP 0028).

#### NOTE

- Foam system agent percentage is preset for turrets and ground sweeps and is not adjustable.
  - The foam system will discharge class A foam at 0.5% at 200 to 210 psi (1,379 to 1,448 kPa). At pressures lower than 200 psi (1,379 kPa), the foam concentrate will be higher.
7. For class A foam, use pressure governor to adjust discharge pressure to desired pressure (WP 0024), depending on type of operation.

#### NOTE

- The foam system will discharge class B foam at 3% at 200 to 210 psi (1,379 to 1,448 kPa). Class B foam should not be discharged at reduced pressures.
  - Activating the PRESET switch on the pressure governor (pressure mode), will automatically increase the discharge pressure to 200 to 210 psi (1,379 to 1,448 kPa).
8. For class B foam, use pressure governor to adjust discharge pressure to 200 to 210 psi (1,379 to 1,448 kPa) (WP 0024).

**END OF TASK**

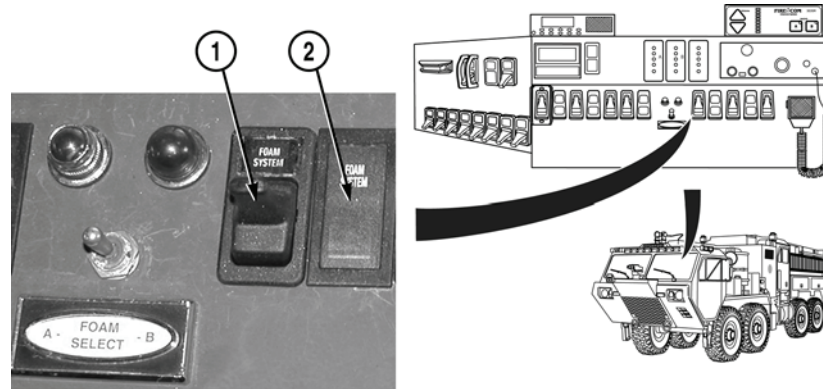
**STOPPING FOAM SOLUTION FLOW****NOTE**

When performing Step (1), FOAM TANK SUPPLY valve will automatically shut off.

1. Put FOAM SYSTEM switch (1) to OFF position. Indicator light (2) will go out.

**END OF TASK****FOAM SYSTEM DEACTIVATION/CLEAN-UP****NOTE**

When performing Step (1), FOAM TANK SUPPLY valve will automatically shut off.

1. Put FOAM SYSTEM switch (1) to OFF position. Indicator light (2) will go out.
2. Set pressure governor to idle (WP 0024).
3. Perform appropriate foam system flushing procedure (WP 0031).

**END OF TASK****END OF WORK PACKAGE**



---

**OPERATOR MAINTENANCE**  
**BUMPER TURRET OPERATION**

---

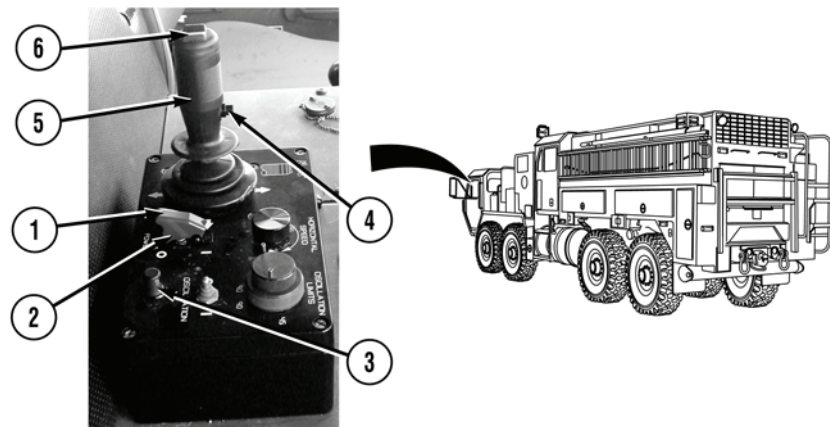
**WARNING**

**Turret should never be pointed at personnel. Failure to comply may result in injury or death to personnel.**

**NOTE**

Bumper turret is controlled from inside personnel cab by using joystick control box.

1. Lift power switch guard (1) and put power switch (2) to | (on) position. Indicator light (3) will illuminate.
2. Push and release agent discharge button (4) on front of joystick control handle (5) to begin discharge.

**NOTE**

Pattern control button, located on top of joystick, controls nozzle discharge pattern. Pressing switch to left changes nozzle pattern to fog pattern. Pressing switch to right changes nozzle pattern to straight stream.

3. Press pattern control button (6) to desired pattern.

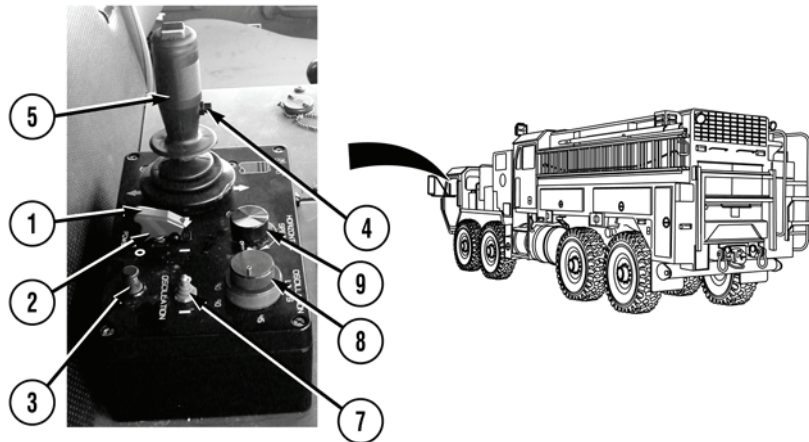

### NOTE

- Perform Steps (4) through (6) to activate automatic oscillation.
- The joystick control handle is designed to override the automatic oscillation. Moving the joystick left or right will automatically disengage automatic oscillation. The bumper turret nozzle can be elevated or depressed when in automatic oscillation, and automatic oscillation will not disengage.

4. Put OSCILLATION switch (7) to | (on) position.
5. Set OSCILLATION LIMITS control knob (8) to desired position.
6. Set HORIZONTAL SPEED (9) to desired position.
7. Complete mission.
8. Push and release discharge control button (4) on front of joystick (5) to stop discharge.
9. Put OSCILLATION switch (7) to ○ (off) position.
10. Point bumper turret straight ahead.
11. Lift power switch guard (1) and put POWER switch (2) to ○ (off) position. Indicator light (3) will go out.

**END OF TASK**

**END OF WORK PACKAGE**



---

**OPERATOR MAINTENANCE****ROOF TURRET OPERATION**

---

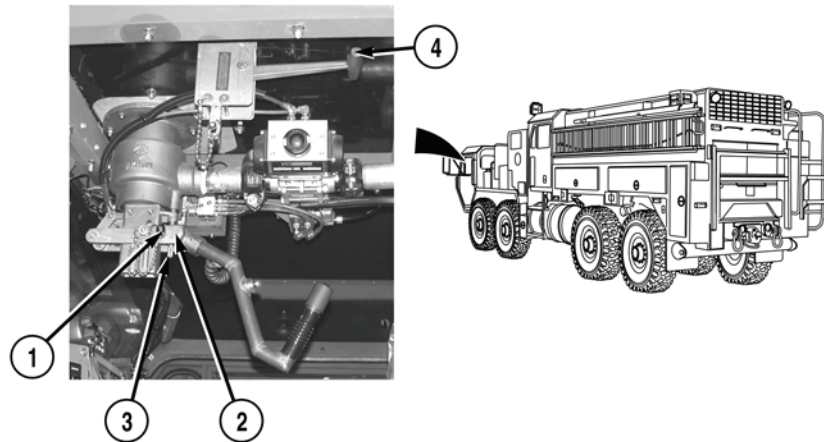
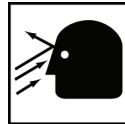
**WARNING**

**Turret should never be pointed at personnel. Failure to comply may result in injury or death to personnel.**

1. Remove pin (1) from handle yoke and drive socket (2).

**NOTE**

Knurled rod is not completely removed from handle yoke and drive socket. Knurled rod is not threaded.

2. Pull knurled rod (3) from handle yoke and drive socket (2).
3. Move pattern control lever (4) up to select straight stream pattern, or pull down to select fog pattern.

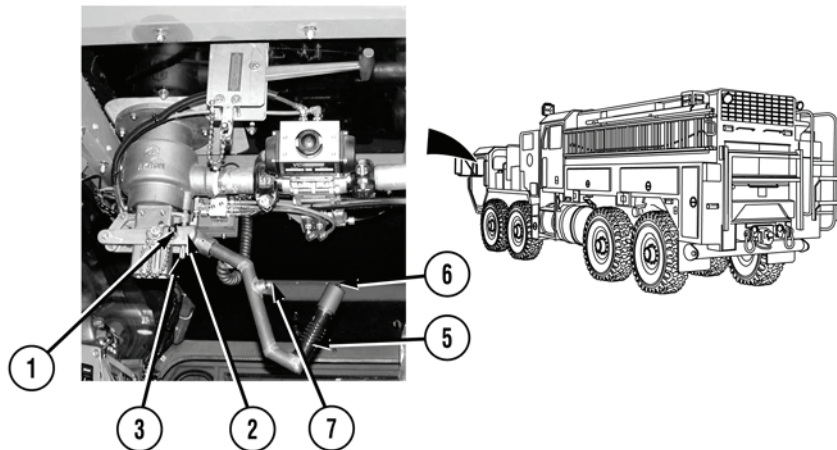
**WARNING**

**Keep a firm grip on roof turret control handle when roof turret is discharging water. Failure to comply may result in injury to personnel.**

**NOTE**

Pulling handle down will raise roof turret nozzle. Pushing handle up will lower roof turret nozzle. Pushing handle to left will move roof turret to right. Pushing handle right will move roof turret to left.

4. With a firm grip on roof turret control handle (5), push and release agent discharge button (6) on roof turret control handle (5) to engage roof turret.
5. Make sure indicator light (7) illuminates on roof turret control handle (5).
6. Complete mission.
7. Push and release agent discharge button (6) on roof turret control handle (5) to disengage roof turret.
8. Indicator light (7) will go out on roof turret control handle (5).
9. Return roof turret to center position.
10. Push up on roof turret control handle (5).
11. Secure knurled rod (3) on handle yoke and drive socket (2).
12. Install pin (1) on handle yoke and drive socket (2).

**END OF TASK**

**END OF WORK PACKAGE**

---

**OPERATOR MAINTENANCE**
**CORD REEL OPERATION**

---

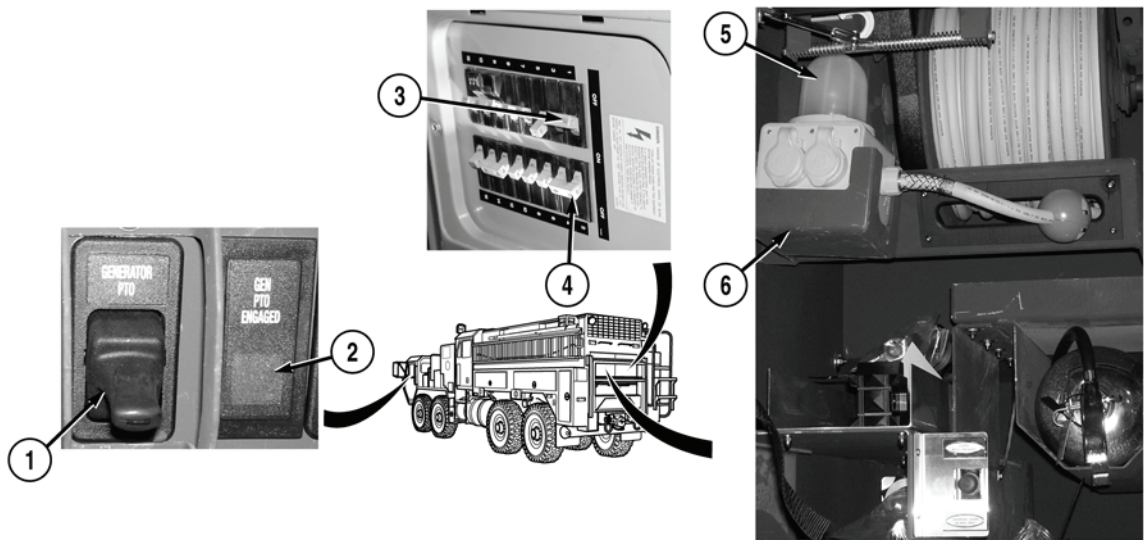
**STARTING CORD REEL OPERATION**

1. Put GENERATOR PTO switch (1) to on position. Indicator light (2) will illuminate.
2. Unstow rear work platform (WP 0037).
3. Open rear compartment door (WP 0010).
4. Put breakers 1 and 3 (3) and 2 and 4 (4) to ON position.
5. Remove light box (5) from bracket (6).
6. Pull light box (5) to required location.
7. Complete mission.

**END OF TASK**

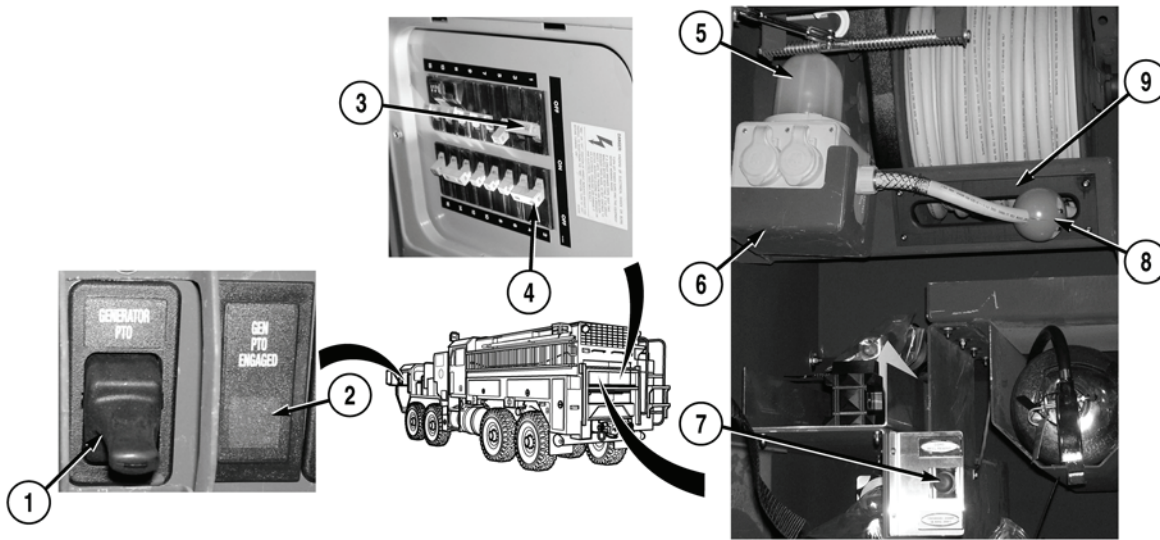
**STOPPING CORD REEL OPERATION**

1. Push CORD REEL REWIND button (7), until cord stop (8) is in contact with cord reel frame (9).
2. Stow light box (5) in bracket (6).
3. Put breakers 1 and 3 (3) and 2 and 4 (4) to OFF position.
4. Close rear compartment door (WP 0010).
5. Stow rear work platform (WP 0014).
6. Put GENERATOR PTO switch (1) to off position. Indicator light (2) will go out.

**END OF TASK****END OF WORK PACKAGE**

---

**OPERATOR MAINTENANCE**  
**WINDSHIELD DELUGE OPERATION**

---

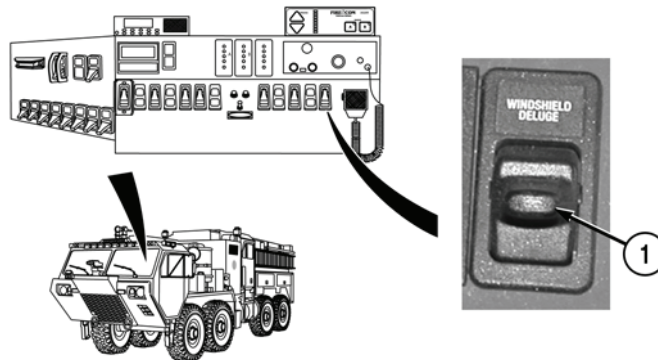
**STARTING WINDSHIELD DELUGE SYSTEM**

1. Make sure there is water in water tank.
2. Put WINDSHIELD DELUGE switch (1) to on position.

**END OF TASK****STOPPING WINDSHIELD DELUGE SYSTEM**

Turn WINDSHIELD DELUGE switch (1) to off position.

**END OF TASK****END OF WORK PACKAGE**



---

**OPERATOR MAINTENANCE**  
**GROUND SWEEPS OPERATION**

---

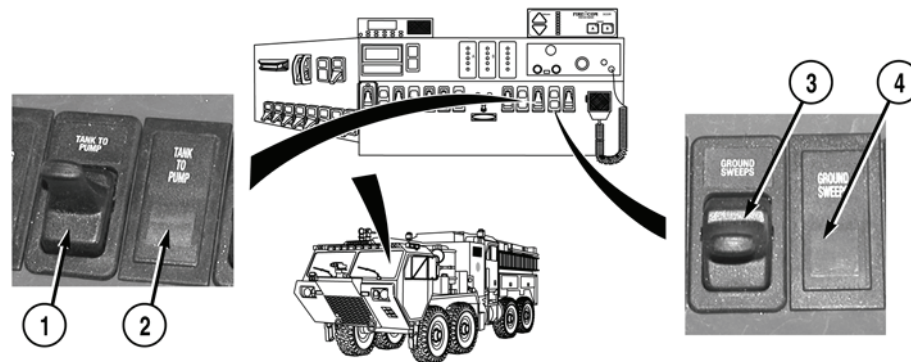
**STARTING GROUND SWEEPS**

1. Make sure crew cab roof hatch is closed and secure (WP 0018).
2. Put TANK TO PUMP switch (1) to on position. Indicator light (2) will illuminate.
3. Start water pump engine (WP 0022).
4. Prime water pump (WP 0023) until pressure registers on pump discharge gauge.
5. Set pressure governor (WP 0024).
6. Put GROUND SWEEPS switch (3) to on position. Indicator light (4) will illuminate.

**END OF TASK****STOPPING GROUND SWEEPS**

1. Put GROUND SWEEPS switch (3) to off position. Indicator light (4) will go out.
2. Turn OFF water pump engine (WP 0022).
3. Put TANK TO PUMP switch (1) to off position. Indicator light (2) will go out.

**END OF TASK****END OF WORK PACKAGE**





---

**OPERATOR MAINTENANCE****FOAM SYSTEM FLUSHING**

---

**FOAM SYSTEM FLUSHING**** CAUTION**

Foam agent can cause operating components, such as valves, to stick if solution is allowed to dry. Many types of foam agents have penetrating properties, which can remove or accelerate deterioration of greases and/or lubricants. Special attention should be given to lubrication requirements of equipment normally in contact with foam solution such as valves, monitors, nozzles, etc. More frequent lubrication may be necessary. It is recommended that the water pump and delivery system components be flushed before they are returned to a “ready” condition.

The foam system is composed of materials that are compatible with foam agents.

**END OF TASK****FOAM AGENT PIPING FLUSH PROCEDURE****WARNING**

Open and close all valves slowly during any procedure. Sudden changes in pressure may cause equipment to react faster than personnel can be alerted. Ensure surrounding personnel are aware of changes being made to settings on equipment. Failure to comply may result in injury or death to personnel and damage to equipment.

**NOTE**

- Make sure to close all valves once water runs clear.
- Foam system flushing procedure must be done using onboard water tank.

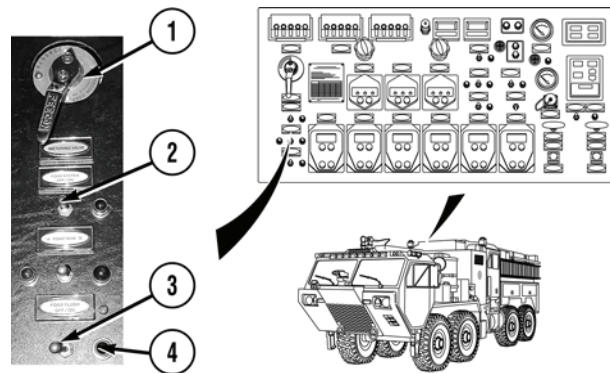

1. Using pressure governor, decrease engine RPM to reduce water pressure (WP 0024).
2. Make sure foam METERING VALVE (1) is in CLOSED position.
3. Make sure FOAM SYSTEM switch (2) is in OFF position.
4. Using pressure governor, adjust main water pump discharge pressure to 125 psi (862 kPa) (WP 0024).
5. Turn FOAM FLUSH switch (3) to ON position. Indicator light (4) will illuminate.

### **WARNING**



**Open and close all valves slowly during any procedure. Sudden changes in pressure may cause equipment to react faster than personnel can be alerted. Ensure surrounding personnel are aware of changes being made to settings on equipment. Failure to comply may result in injury or death to personnel and damage to equipment.**

### **CAUTION**

- **Do not open any foam agent supply tanks while performing flush procedures.**
  - **Do not allow foam system pressure to exceed 250 psi (1,724 kPa). Failure to comply may result in damage to equipment.**
6. Put foam METERING VALVE (1) in fully opened position.

### **NOTE**

- Perform Steps (7) through (13) if discharges were used.
  - While flushing, open and close METERING VALVE two times; continue flushing until water runs clear.
7. Open discharge valves and flush out all discharges that were used, removing foam until water runs clear.
  8. While flushing, open and close foam METERING VALVE (1) twice or until water runs clear from discharge.
  9. Flush portable equipment such as hoses, nozzles, monitors, etc.

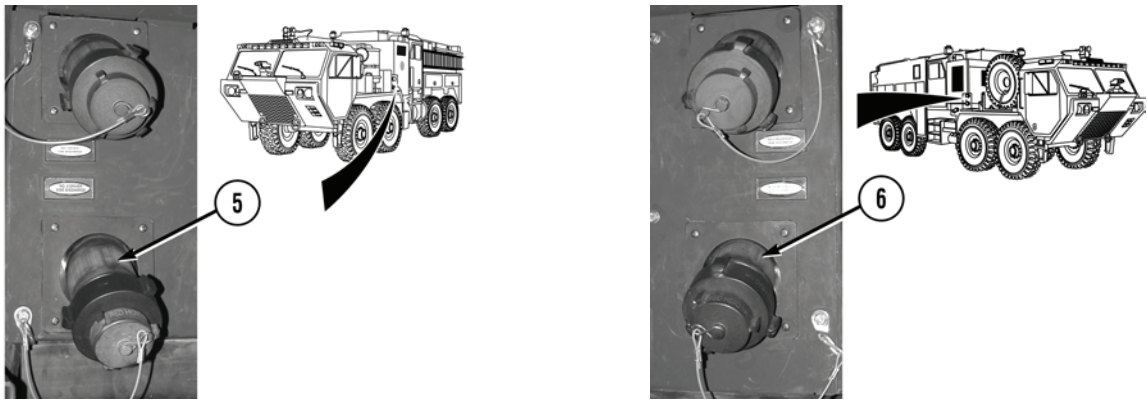
**WARNING**

**Discharge caps should not be removed if water system is pressurized. Discharge caps can act as projectiles if released under pressure, causing injury or death to personnel.**

**NOTE**

Perform Steps (10) through (13) to flush foam system piping to discharges that were not used.

10. Remove two caps from NO. 2 DRIVER SIDE DISCHARGE (5) and NO. 4 PASSENGER SIDE DISCHARGE (6).

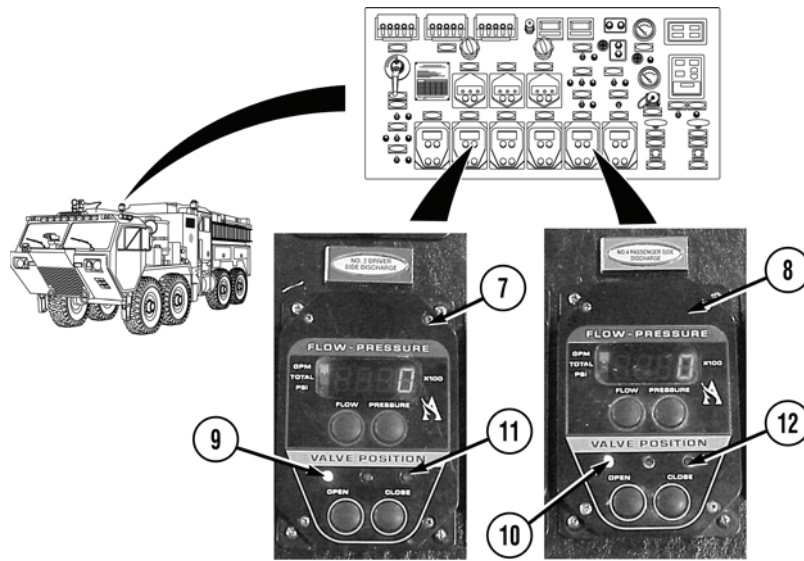

11. Put NO. 2 DRIVER SIDE DISCHARGE valve control (7) and NO. 4 PASSENGER SIDE DISCHARGE valve control (8) in OPEN position. Indicator lights (9 and 10) will illuminate.
12. Flush out NO. 2 DRIVER SIDE DISCHARGE (5) and NO. 4 PASSENGER SIDE DISCHARGE (6) until water runs clear.
13. Put NO. 2 DRIVER SIDE DISCHARGE valve control (7) and NO. 4 PASSENGER SIDE DISCHARGE valve control (8) in CLOSED position. Indicator lights (11 and 12) will illuminate.

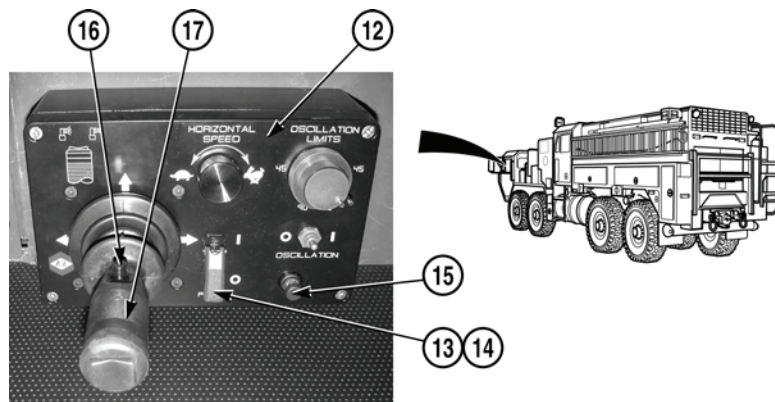

14. Lift switch guard (13) and put power switch (14) in | (on) position. Indicator light (15) will illuminate.
15. Push agent release discharge control button (16) on front of joystick (17) to begin discharge. Push again to shut off.

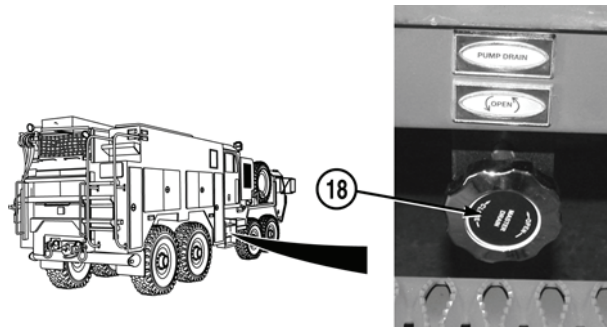

**NOTE**

When opening drain valves, only open valves slightly.

16. Open MASTER DRAIN valve (18) until water runs clear.

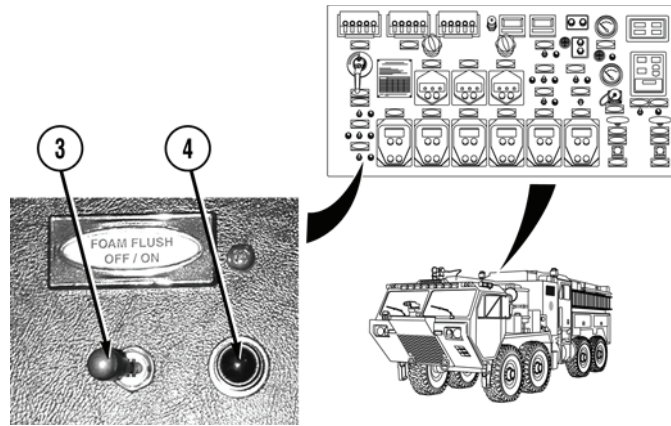

17. Put FOAM FLUSH switch (3) in OFF position. Check that indicator light (4) goes out.

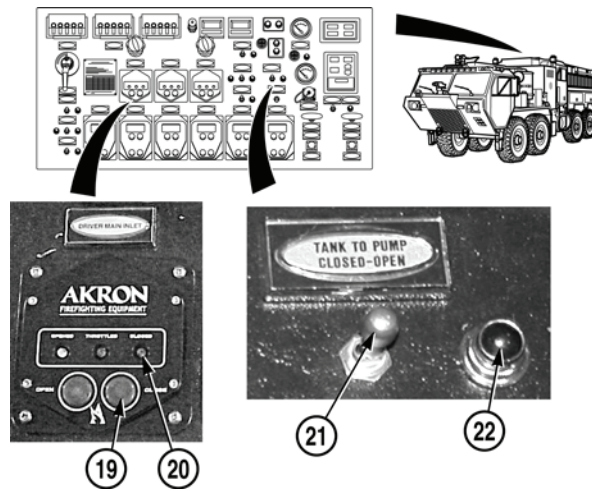

18. Using pressure governor, idle water pump engine (WP 0024).
19. Shut off water pump engine (WP 0022).
20. If used, put DRIVER MAIN INLET valve control (19) in CLOSED position. Indicator light (20) will illuminate.
21. If used, put TANK TO PUMP switch (21) in CLOSED position. Make sure indicator light (22) goes out.
22. Close all flush and drain valves that were opened.

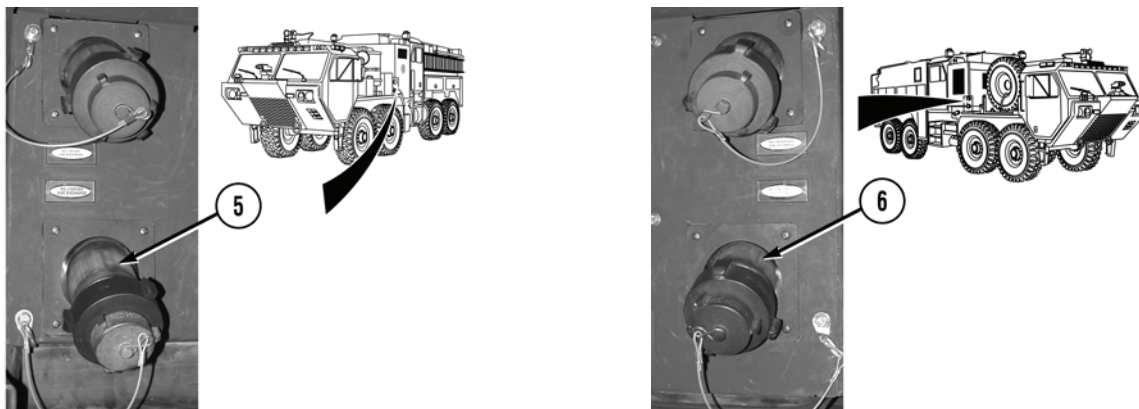

23. Install two caps on NO. 2 DRIVER SIDE DISCHARGE (5) and NO. 4 PASSENGER SIDE DISCHARGE (6).

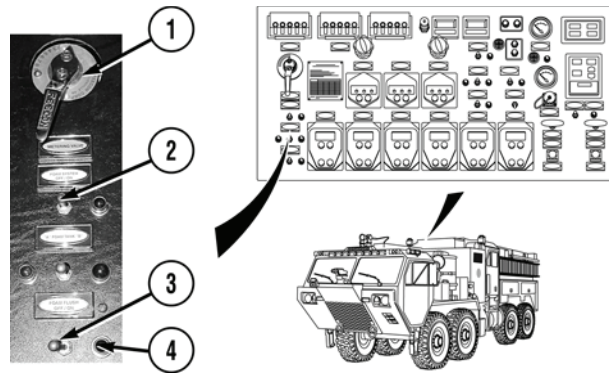

24. Turn foam METERING VALVE (1) to closed position.

**NOTE**

Make sure PUMP COOLER switch is in OFF position.

25. Refill foam agent storage tank to one-half full level in expansion dome with appropriate foam agent (WP 0031).

26. Return all valves and switches to their normal standby position (WP 0032).

**END OF TASK**

**DRAINING FOAM TANKS**

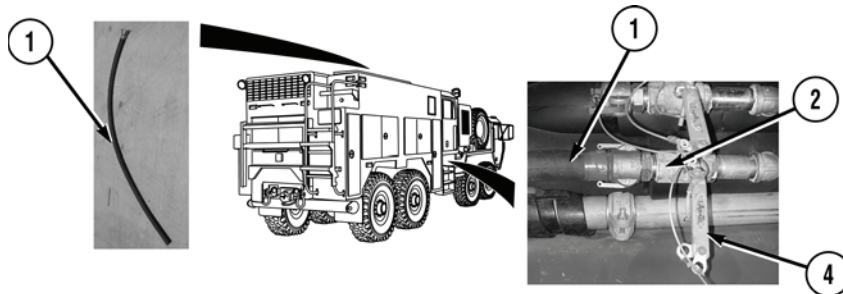

**NOTE**

- Foam drained from foam tanks will need to be drained into properly marked and sealed containers.
- Both foam tanks are drained the same way. Foam tank B shown.

1. Gather suitable containers.
2. Attach drain hose (1) to FOAM TANK DRAIN valve (2).

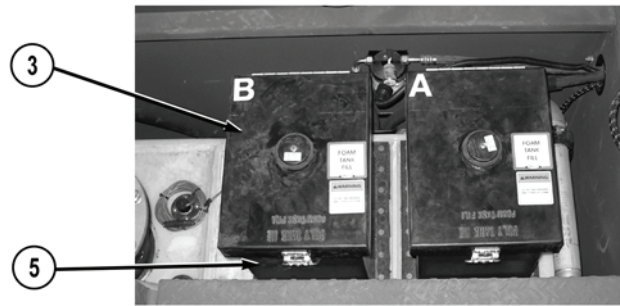

3. Open expansion dome hatch (3).
4. Put FOAM TANK DRAIN valve handle (4) in open position and completely drain foam into containers.
5. Put FOAM TANK DRAIN valve handle (4) in closed position.
6. Properly label the sealed containers when foam is completely drained from foam tank (5).
7. Remove fill tower screen from foam tank (5).

### NOTE

- Defoaming agent can be used in assisting to clean foam tanks.
- Defoaming agent and water must be added into foam tank that is being flushed.

8. Add defoaming agent into foam tank (5).
9. Fill foam tank (5) with warm water.

### END OF TASK

### FLUSHING FOAM TANKS

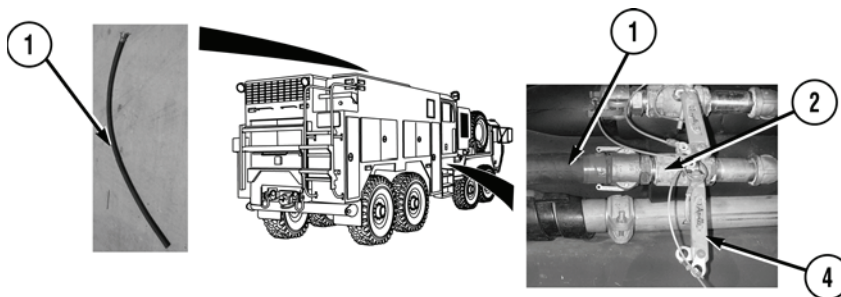

### NOTE

Local draining laws must be followed when draining and flushing foam and water from foam tanks.

1. Put FOAM TANK DRAIN valve handle (4) in open position and drain water from foam tank (5).
2. Repeat Steps (8) through (10) until foam is clean.
3. Put FOAM TANK DRAIN valve handle (4) in closed position.



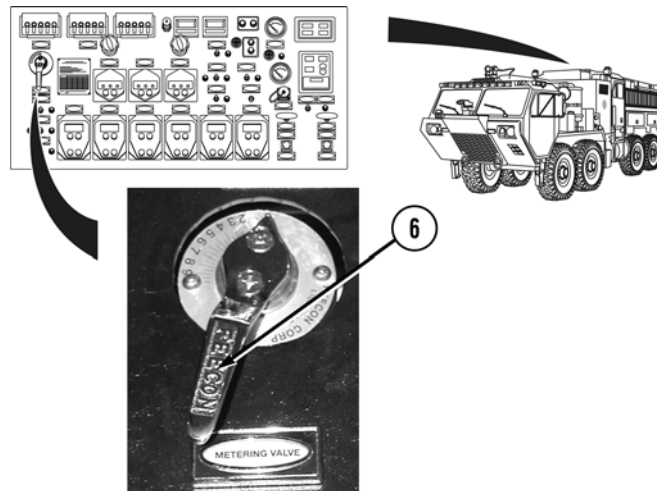

4. Put foam METERING VALVE (6) in OPEN position.

#### NOTE

- Water must be added into foam tank that is being flushed.
  - FOAM TYPE SELECTOR switch must be switched to the foam tank (5) that is being flushed.
5. Run foam system with water instead of foam (WP 0033).
  6. Discharge water until foam tank (5) is empty.
  7. All debris must be removed from foam tanks after flushing is complete.

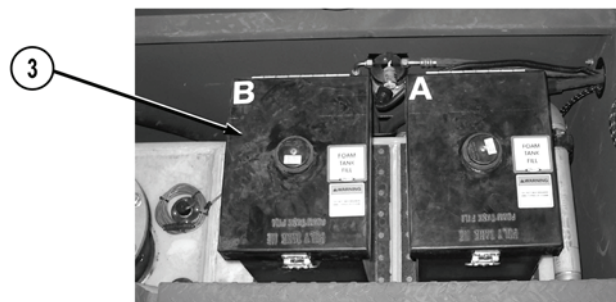

8. Close expansion dome hatch (3).
9. Repeat Steps (1) through (8) to drain and flush foam tank A.
10. Flush foam system (WP 0032).

**END OF TASK**

**END OF WORK PACKAGE**



---

**OPERATOR MAINTENANCE**  
**POST OPERATION PROCEDURES**

---

1. If system was pumping seawater, dirty water, alkaline water, or foam, flush the pump with clean water.

**WARNING**



**Make sure system pressure gauges and hose pressure gauges are at zero prior to disconnecting any suction or discharge hoses or removing caps. System operates at extreme pressure and failure to comply may result in injury or death to personnel.**

2. Make sure all valve controls are in CLOSED position.
3. Disconnect and stow all suction and discharge hoses.

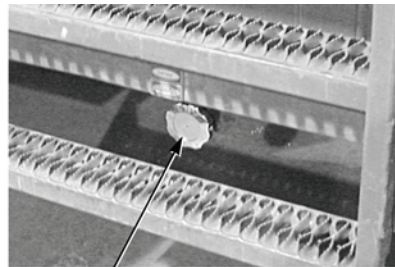

①

**CAUTION**

**Make sure pump is completely drained in freezing weather (WP 0045). Water could freeze and expand, which may cause damage to water pump.**

**NOTE**

Perform Steps (4) through (9) if leaving vehicle in a "Dry Pump" condition (standby condition, dry condition, water tank full).

4. Open MASTER DRAIN valve (1) to relieve pressure.

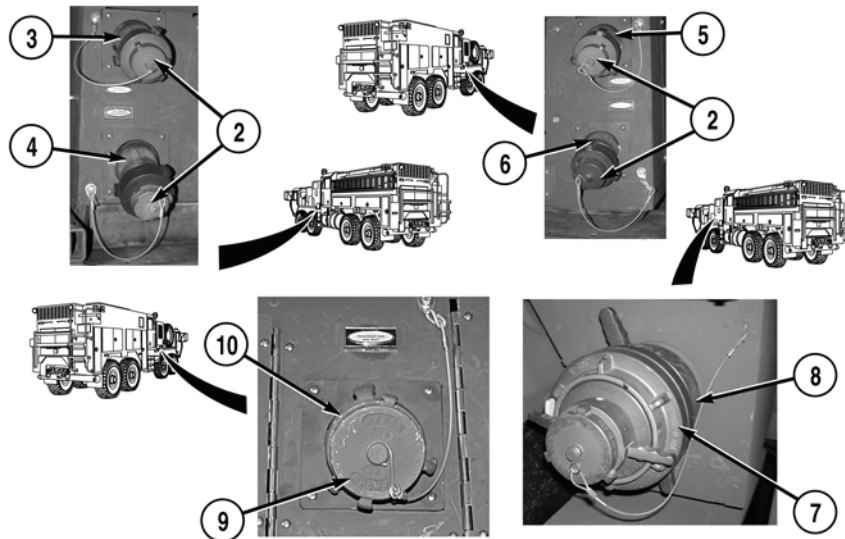

### NOTE

Do not open TANK FILL & RE-CIRCULATING LINE valve control, TANK TO PUMP valve, WATER TANK DRAIN valve, FOAM TANK selector switch valves, or FOAM TANK DRAIN valves.

5. Remove caps (2) from NO.1 DRIVER SIDE DISCHARGE (3), NO. 2 DRIVER SIDE DISCHARGE (4), NO. 3 PASSENGER SIDE DISCHARGE (5), and NO. 4 PASSENGER SIDE DISCHARGE (6).
6. Remove cap (7) from main inlet (8).
7. Remove cap (9) from PASSENGER SIDE AUX. INLET (10).

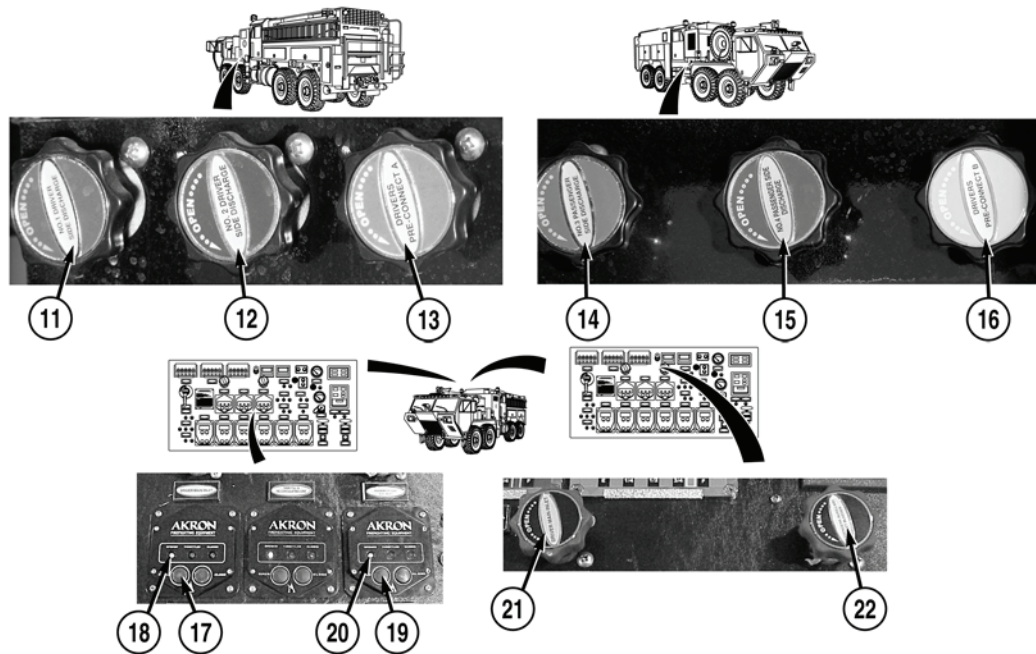

### NOTE

Hand operated drain valves only open 1/4 of a turn.

8. Put NO. 1 DRIVER SIDE DISCHARGE (11), NO. 2 DRIVER SIDE DISCHARGE (12) and DRIVER PRE-CONNECT A (13) drain valves to open position.
9. Put NO. 3 PASSENGER SIDE DISCHARGE (14), NO. 4 PASSENGER SIDE DISCHARGE (15) and DRIVER PRE-CONNECT B (16) drain valves to open position.
10. Push DRIVER MAIN INLET valve control OPEN button (17) until green indicator light (18) illuminates.
11. Push PASSENGER SIDE AUX. INLET valve control OPEN button (19) until green indicator light (20) illuminates.
12. Put DRIVER MAIN INLET BLEEDER valve (21) and PASSENGER AUXILIARY INLET BLEEDER valve (22) to OPEN position.

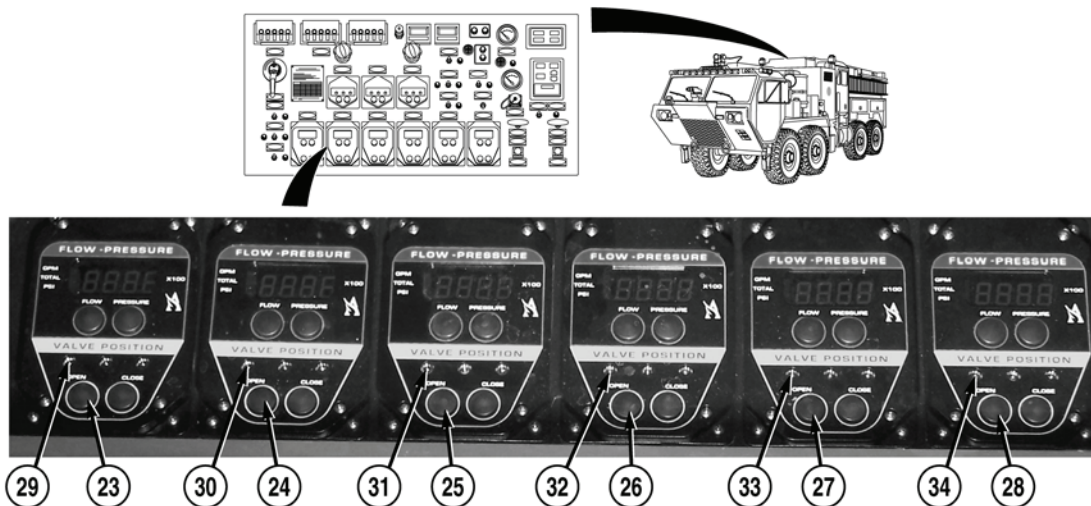

**NOTE**

Valves are completely open when green indicator light illuminates.

13. Push NO. 1 DRIVER SIDE DISCHARGE (23), NO. 2 DRIVER SIDE DISCHARGE (24), NO. 3 PASSENGER SIDE DISCHARGE (25), NO. 4 PASSENGER SIDE DISCHARGE (26), DRIVERS PRE-CONNECT A (27), and DRIVERS PRE-CONNECT B (28) valve control OPEN buttons until green indicator lights (29), (30), (31), (32), (33), and (34) illuminate.

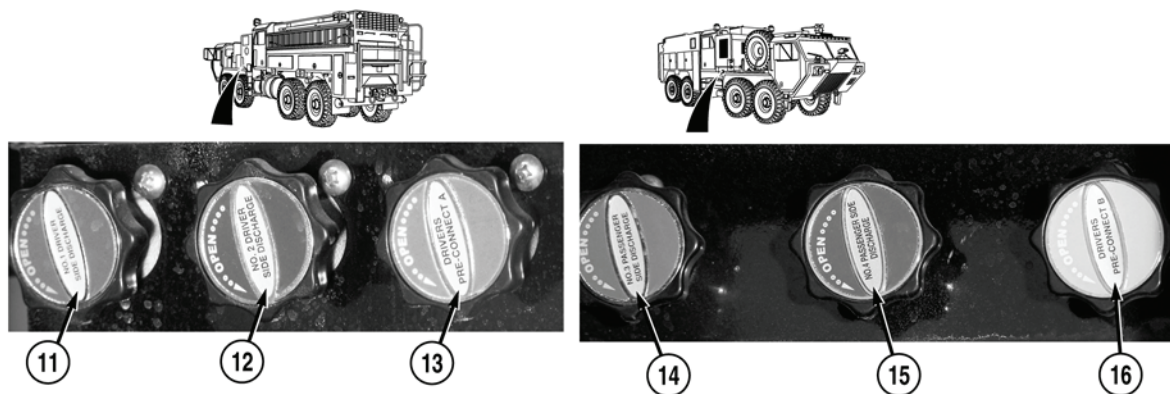

14. Put NO. 1 DRIVER SIDE DISCHARGE (11), NO. 2 DRIVER SIDE DISCHARGE (12) and DRIVER PRE-CONNECT A (13) drain valves to closed position.
15. Put NO. 3 PASSENGER SIDE DISCHARGE (14), NO. 4 PASSENGER SIDE DISCHARGE (15) and DRIVER PRE-CONNECT B (16) drain valves to closed position.

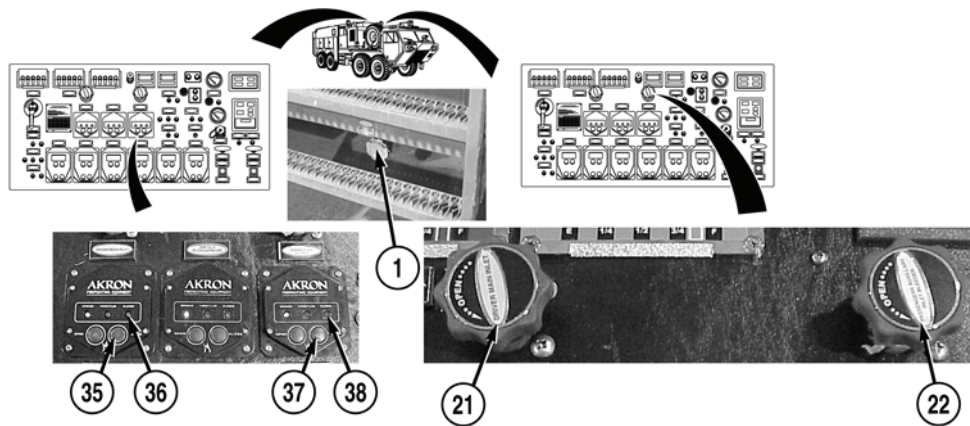

16. Push DRIVER MAIN INLET valve control CLOSE button (35) until red indicator light (36) illuminates.
17. Push PASSENGER SIDE AUX. INLET valve control CLOSE button (37) until red indicator light (38) illuminates.
18. Put DRIVERS MAIN INLET BLEEDER valve (21) and PASSENGER AUXILIARY INLET BLEEDER valve (22) to off position.
19. Put MASTER DRAIN valve (1) to closed position.

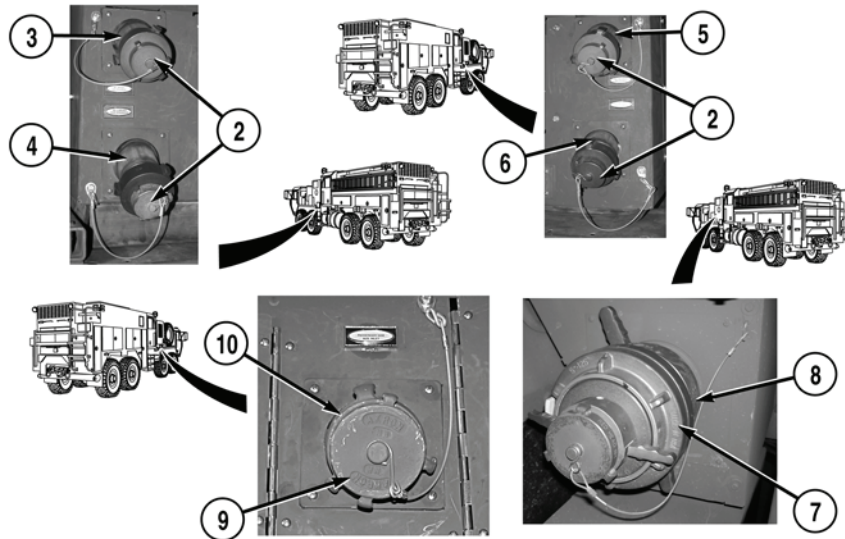

20. Install caps (2) on NO. 1 DRIVER SIDE DISCHARGE (3), NO. 2 DRIVER SIDE DISCHARGE (4), NO. 3 PASSENGER SIDE DISCHARGE (5), and NO. 4 PASSENGER SIDE DISCHARGE (6).
21. Install cap (7) on main inlet (8).
22. Install cap (9) on PASSENGER SIDE AUX. INLET (10).
23. If required, follow SOP and fill out pump run log, indicating total pumping time and out-of-station time.
24. Report all pump, truck equipment malfunctions, and irregularities to your Supervisor.

**END OF TASK**

**END OF WORK PACKAGE**



---

**OPERATOR MAINTENANCE**

**WATER PUMP AND WATER TANK FLUSH**

---

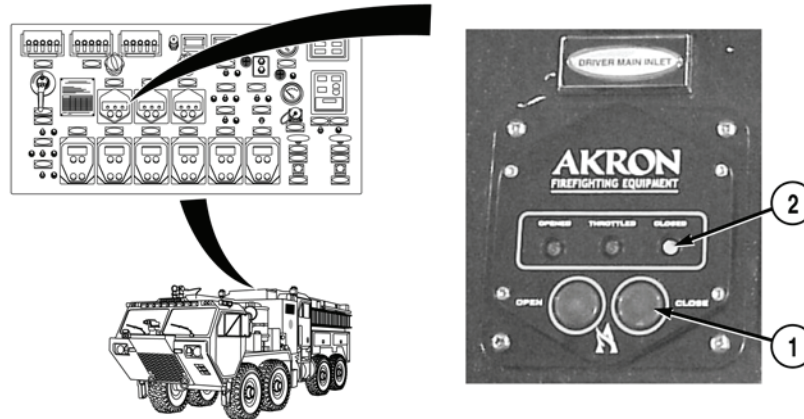
**WATER PUMP FLUSH****NOTE**

- Valve is completely closed when red indicator light illuminates.
  - Main inlet may be operated with either a 5 in. (13 cm) or 3 in. (7.6 cm) suction hose.
  - 5 in. (13 cm) and 3 in. (7.6 cm) suction hoses operate the same way.
1. Push DRIVER MAIN INLET valve control CLOSE button (1) until red indicator light (2) illuminates.

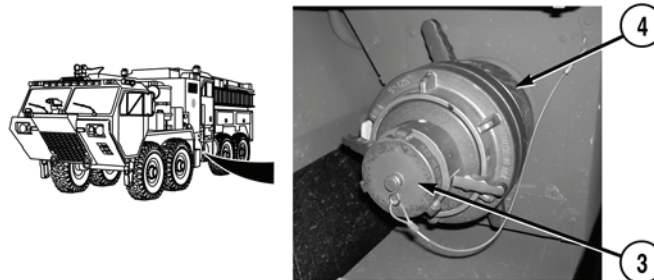

2. Remove cap (3) from driver main inlet (4).

**WARNING**

**Do not use hard suction hose for Step (3). Hard suction hose will not hold pressure. Hose may fail and separate causing injury to personnel and damage to equipment.**

3. Connect 5 in. (13 cm) or 3 in. (7.6 cm) soft suction hose to driver main inlet (4) and positive water source.

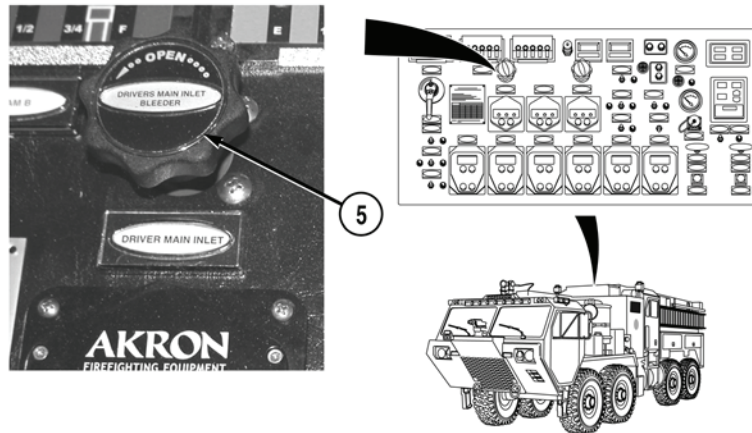

**WARNING**



Open and close all valves slowly during any procedure. Sudden changes in pressure may cause equipment to react faster than personnel can be alerted. Ensure surrounding personnel are aware of changes being made to settings on equipment. Failure to comply may result in injury or death to personnel and damage to equipment.

4. Open DRIVER MAIN INLET BLEEDER valve (5) until water discharges to ground.
5. Close DRIVER MAIN INLET BLEEDER valve (5).

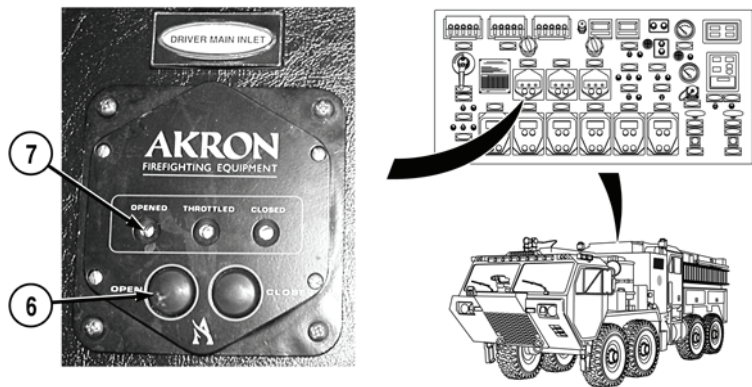

**NOTE**

Valve is completely open when green indicator light illuminates.

6. Push DRIVER MAIN INLET valve control OPEN button (6) until green indicator light (7) illuminates.

**WARNING**

**Do not let pressure exceed 125 psi (862 kPa). Failure to comply may result in injury or death to personnel or damage to equipment.**

**NOTE**

If pressure exceeds 125 psi (862 kPa) notify Supervisor.

7. Start water pump engine (WP 0022).
8. Open supply valve on positive water source.
9. Prime water pump (WP 0023).
10. Set pressure governor (WP 0024).

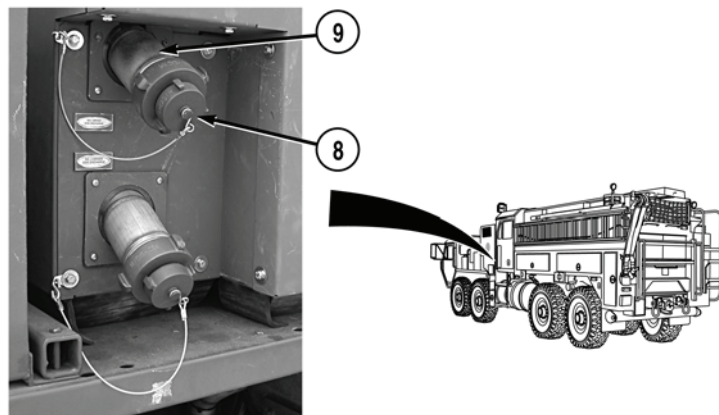
**CAUTION**

**Cavitation can occur when pumping and air enters water. If engine speed increases without an increase in pressure, pump may be cavitating. Even though pump may be primed, air leaks can cause rough operation and an increase in engine speed without an increase in pressure or flow. If an air leak is suspected, discontinue pumping and isolate problem. Cavitation can also occur with large nozzle tips. Solve this problem by reducing flow. Failure to comply may result in damage to water pump.**

11. Remove cap (8) from NO. 1 DRIVER SIDE DISCHARGE (9).

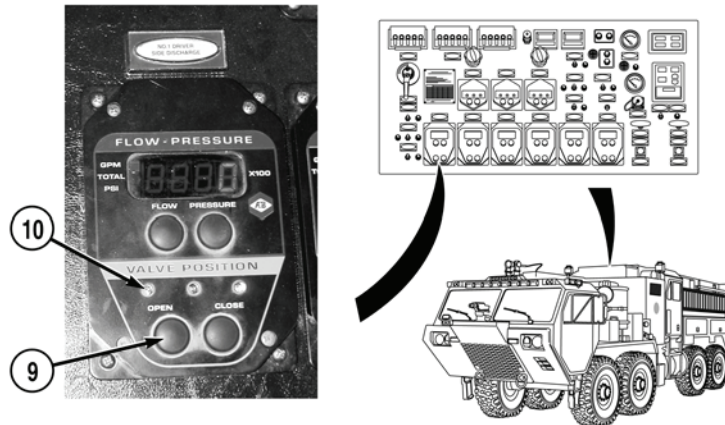

12. Push NO. 1 DRIVER SIDE DISCHARGE valve control OPEN button (9) until green indicator light (10) illuminates.
13. Flush water pump clean.
14. Shut off water pump engine (WP 0022).

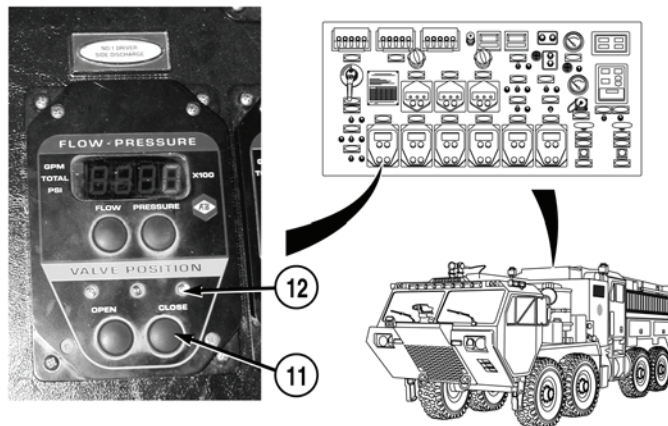

15. Push NO. 1 DRIVER SIDE DISCHARGE valve control CLOSE button (11) until red indicator light (12) illuminates.

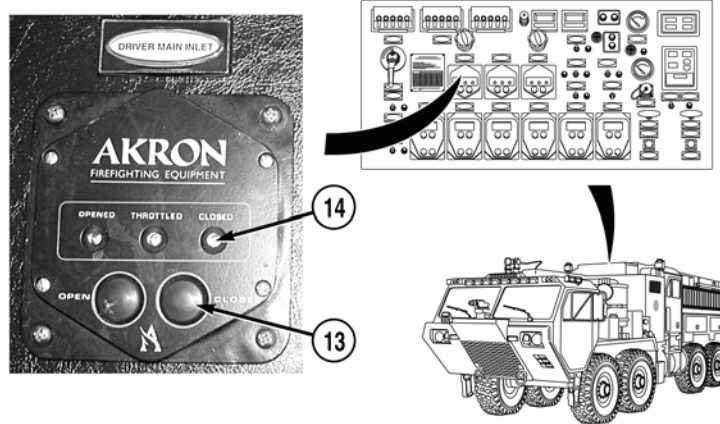

16. Close supply valve on positive water source.
17. Push DRIVER MAIN INLET valve control CLOSE button (13) until red indicator light (14) illuminates.

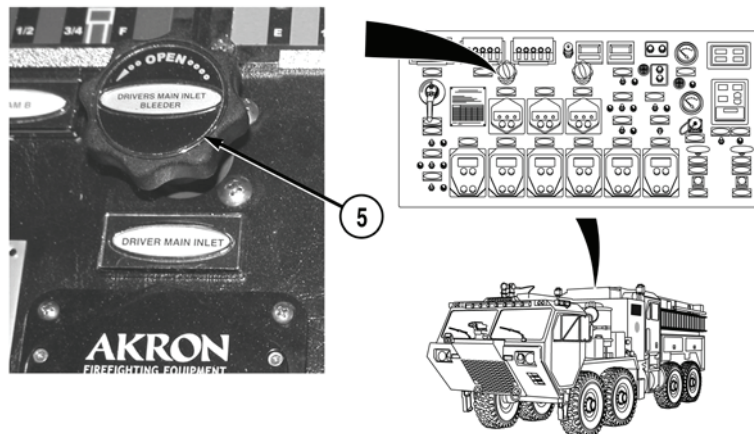

18. Open DRIVER MAIN INLET BLEEDER valve (5).
19. Relieve pressure in soft suction hose.
20. Close DRIVER MAIN INLET BLEEDER valve (5).

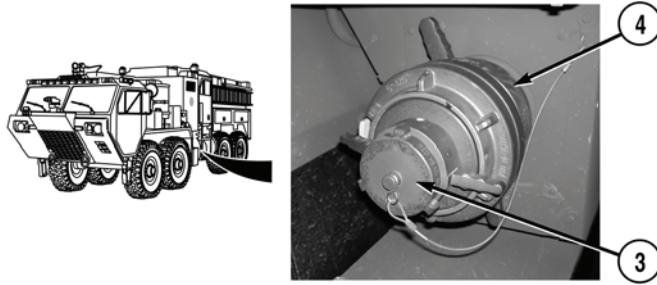

21. Disconnect 5 in. (13 cm) or 3 in. (7.6 cm) soft suction hose from driver main inlet (4) and positive water source.
22. Install cap (3) on driver main inlet (4).

**END OF TASK****WATER TANK FLUSH****NOTE**

When performing water tank flush, water tank must be filled using a positive water source.

1. Fill water tank (WP 0020).
2. Drain water tank (WP 0029).

**END OF TASK****END OF WORK PACKAGE**

---

**OPERATOR MAINTENANCE**  
**PREPARATION FOR STORAGE OR SHIPMENT**

---

**PREPARATION FOR STORAGE (LONG TERM - 6 MONTHS OR LONGER)**

1. Position vehicle in a suitable location to drain and pump out remaining water.
2. Drain and flush foam tanks (WP 0031).
3. Flush water pump and tank (WP 0042).
4. Perform Preventive Maintenance Checks and Services and Lubrication procedures (WP 0186).

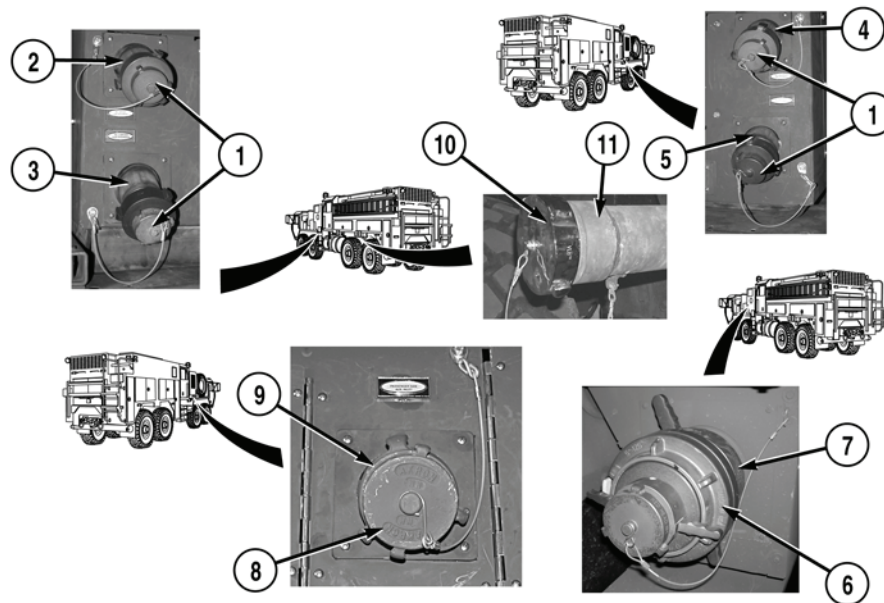

5. Remove caps (1) on NO. 1 DRIVER SIDE DISCHARGE (2), NO. 2 DRIVER SIDE DISCHARGE (3), NO. 3 PASSENGER SIDE DISCHARGE (4), and NO. 4 PASSENGER SIDE DISCHARGE (5).
6. Remove cap (6) on main inlet (7).
7. Remove cap (8) on PASSENGER SIDE AUX. INLET (9).
8. Remove cap (10) on DIRECT TANK FILL inlet (11).

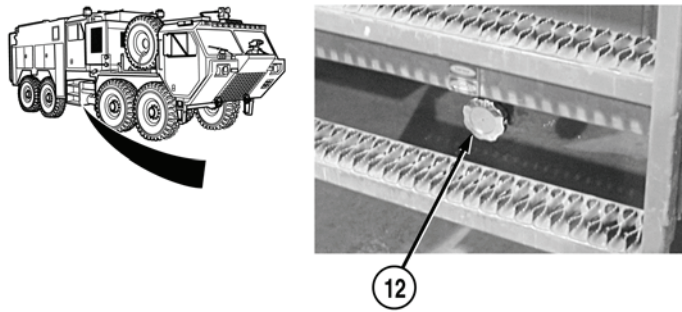

9. Put MASTER DRAIN valve (12) to OPEN position.

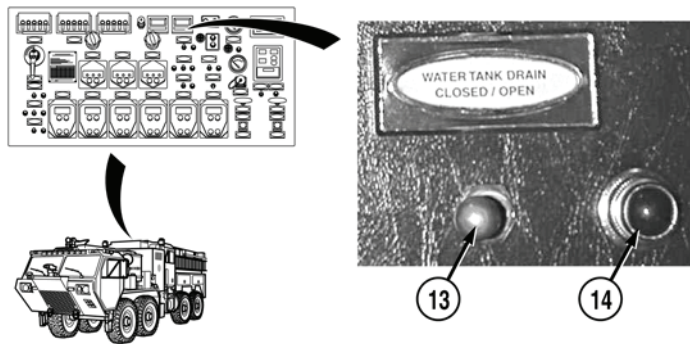

10. Put WATER TANK DRAIN switch (13) to OPEN position. Indicator light (14) will illuminate.

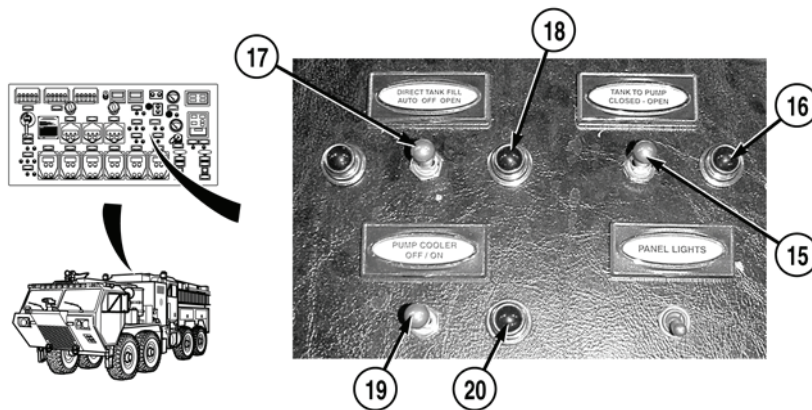

11. Put TANK TO PUMP switch (15) to OPEN position. Indicator light (16) will illuminate.

12. Put DIRECT TANK FILL switch (17) to OPEN position. Indicator light (18) will illuminate.

13. Put PUMP COOLER switch (19) to ON position. Indicator light (20) will illuminate.



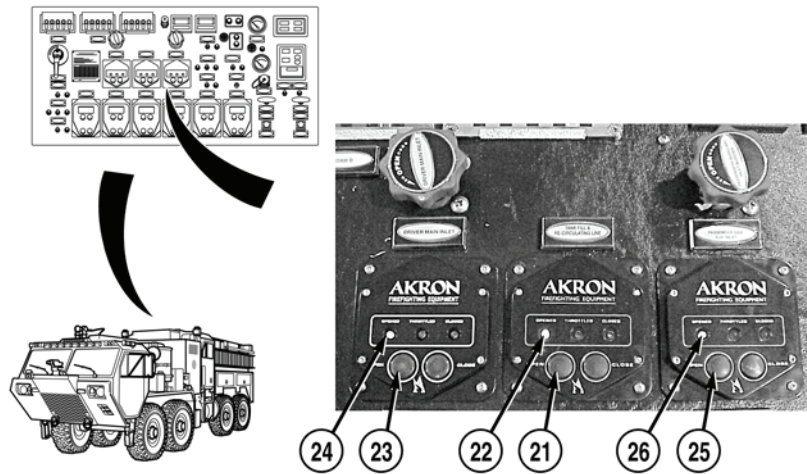

**NOTE**

Valve is completely open when green indicator light illuminates.

14. Push TANK FILL & RE-CIRCULATING LINE valve control OPEN button (21) until green indicator light (22) illuminates.
15. Push DRIVER MAIN INLET valve control OPEN button (23) until green indicator light (24) illuminates.
16. Push PASSENGER SIDE AUX. INLET valve control OPEN button (25) until green indicator light (26) illuminates.

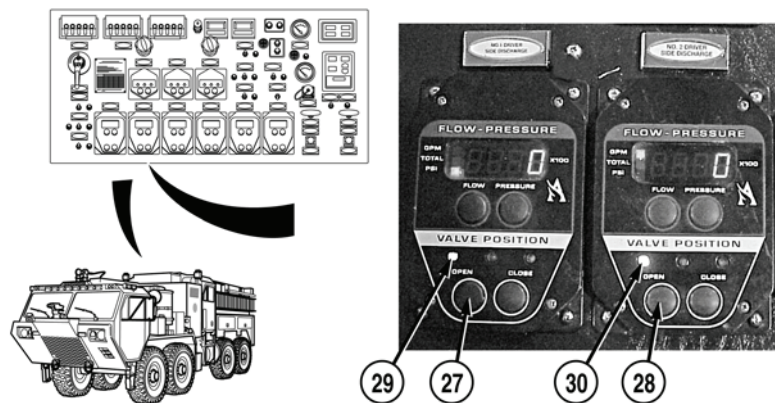

17. Push NO. 1 DRIVER SIDE DISCHARGE and NO. 2 DRIVER SIDE DISCHARGE valve control OPEN buttons (27) and (28) until green indicator lights (29) and (30) illuminate.

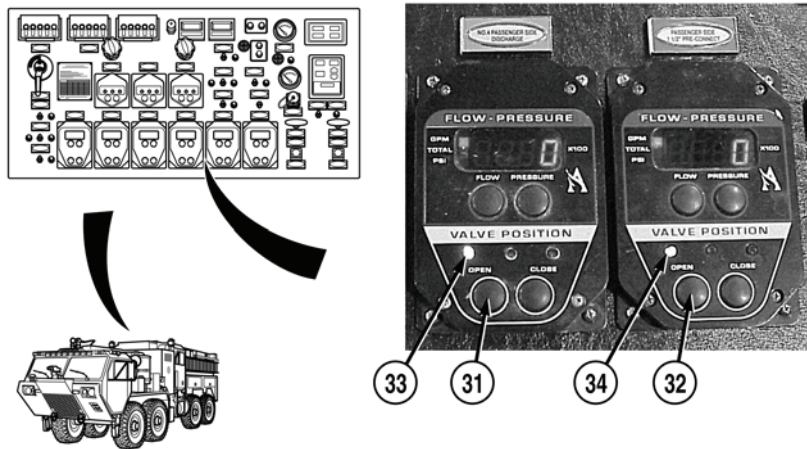

18. Push NO. 3 PASSENGER SIDE DISCHARGE and NO. 4 PASSENGER SIDE DISCHARGE valve control OPEN buttons (31) and (32), until green indicator lights (33) and (34) illuminate.

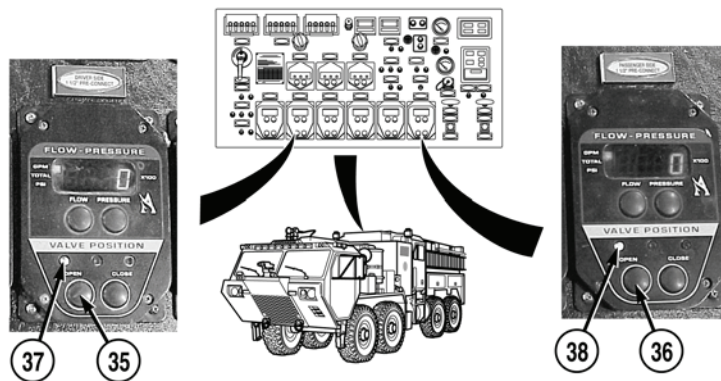

19. Push DRIVERS PRE-CONNECT A and DRIVERS PRE-CONNECT B valve control OPEN buttons (35) and (36) until green indicator lights (37) and (38) illuminate.

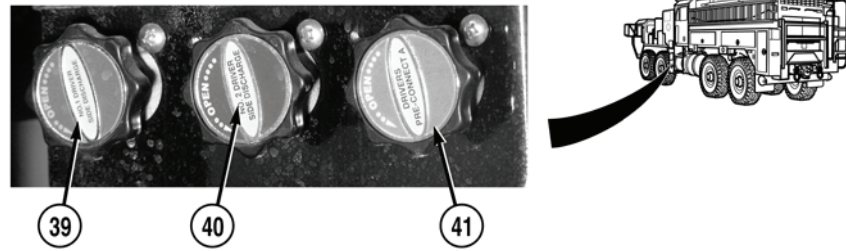
**NOTE**

Discharge drain valves only open 1/4 turn.

20. Put NO. 1 DRIVER SIDE DISCHARGE (39), NO. 2 DRIVER SIDE DISCHARGE (40) and DRIVERS PRE-CONNECT A (41) drain valves to open position.

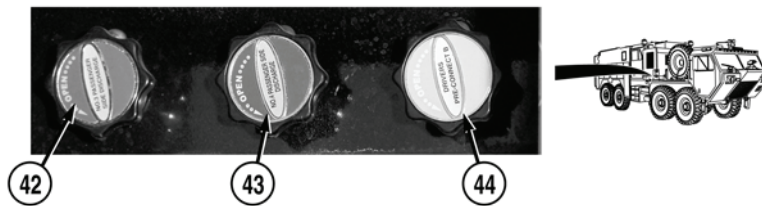

21. Put NO. 3 PASSENGER SIDE DISCHARGE (42), NO. 4 PASSENGER SIDE DISCHARGE (43) and DRIVERS PRE-CONNECT B (44) drain valves to open position.

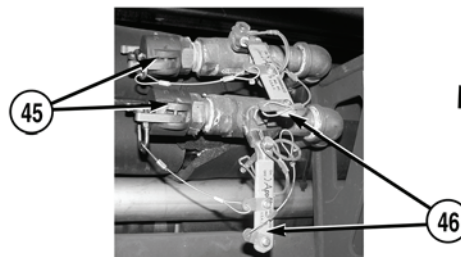

22. Remove two foam drain valve caps (45) from FOAM TANK drain valves (46).
23. Put two FOAM TANK drain valves (46) to open position.

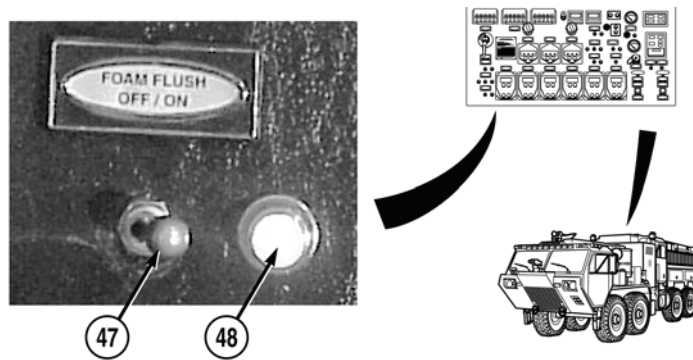

24. Put FOAM FLUSH switch (47) to ON position. Indicator light (48) will illuminate.

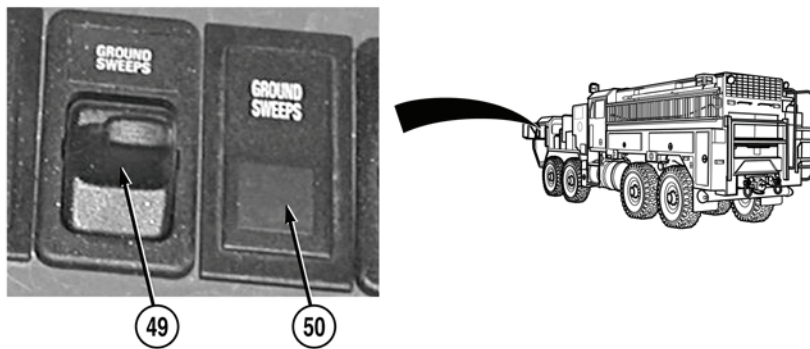

25. Put GROUND SWEEPS switch (49) to on position. Indicator light (50) will illuminate.

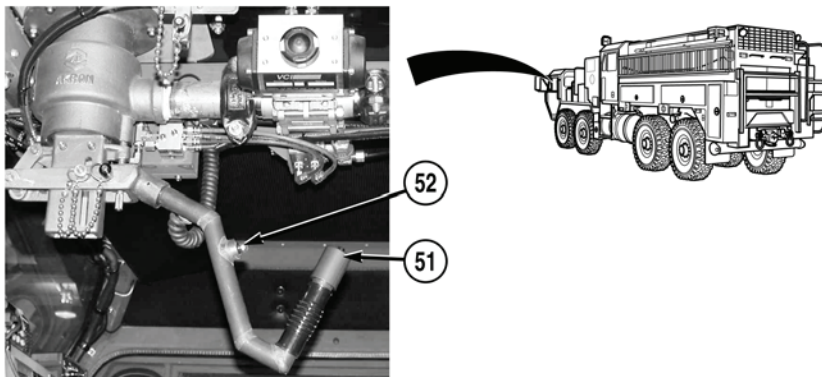

**WARNING**

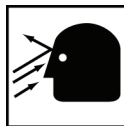

**Turrets never should be pointed at personnel. Failure to comply may result in injury or death to personnel.**

26. Push agent discharge button (51) to on position. Indicator light (52) will illuminate.

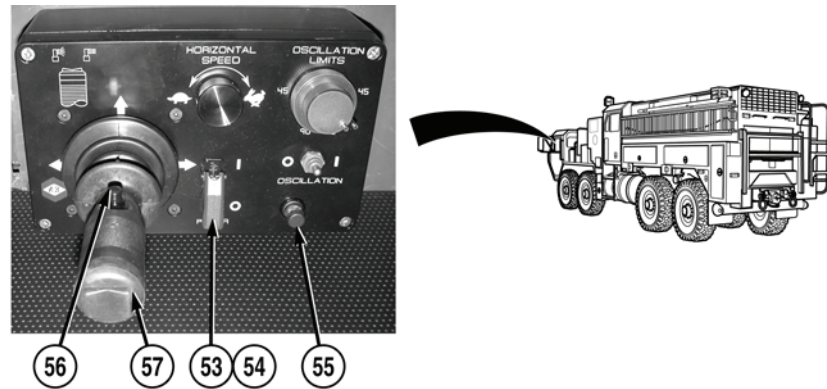

27. Lift power switch guard (53) and put POWER switch (54) to | (on) position. Indicator light (55) will illuminate.
28. Push and release agent discharge button (56) on front of joystick control handle (57) to begin discharge.

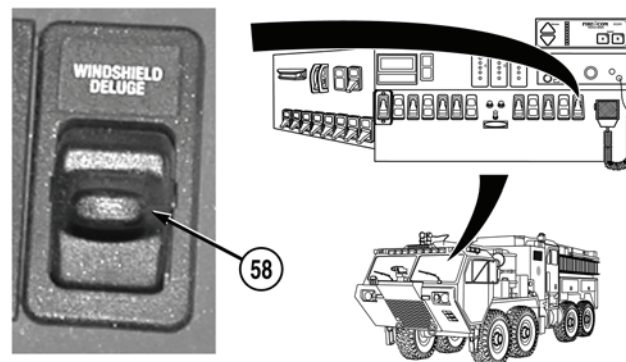

29. Put WINDSHIELD DELUGE switch (58) to on position, and discharge water for 15 to 30 seconds.

### NOTE

All valves should be left open for up to 24 hours, to allow for evaporation of water from system.

30. Push and release agent discharge button (56) on front of joystick control handle (57) to stop discharge.
31. Put POWER switch (54) to ○ (off) position indicator light (55) will go out.

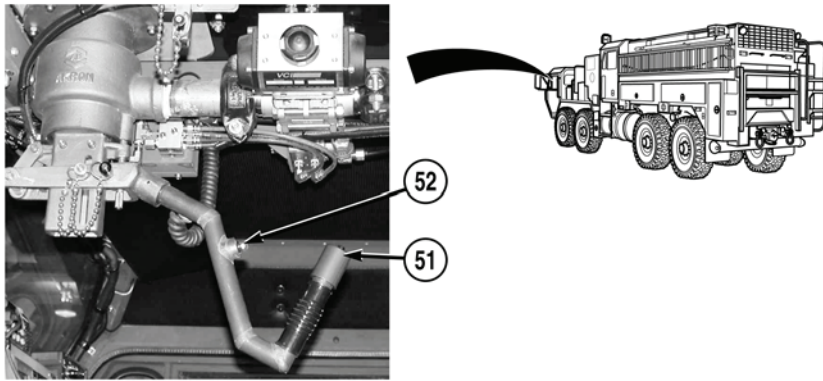

32. Push agent discharge button (51) to off position. Indicator light (52) will go out.

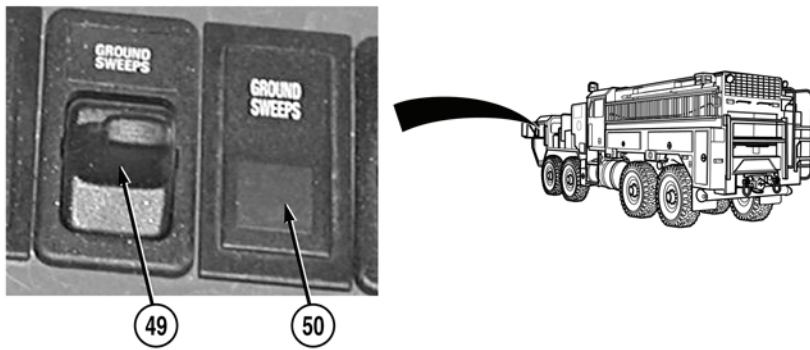

33. Put GROUND SWEEPS switch (49) to off position. Indicator light (50) will go out.

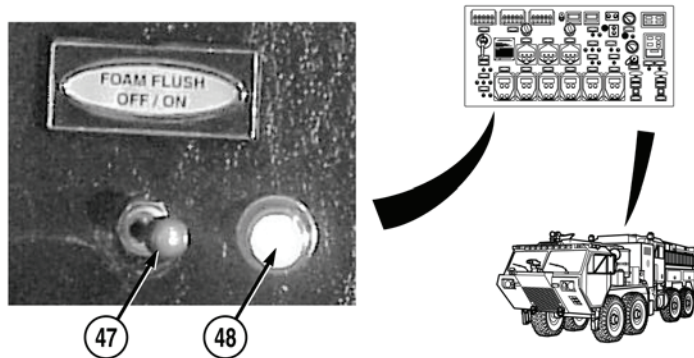

34. Put FOAM FLUSH switch (47) to OFF position. Indicator light (48) will go out.

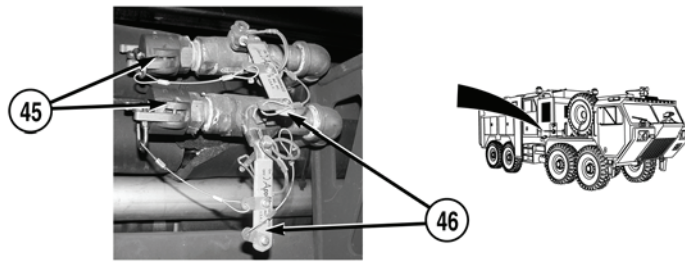

- 35. Put two FOAM TANK drain valves (46) to closed position.
- 36. Put two FOAM DRAIN valve caps (45) on FOAM TANK drain valves (46).

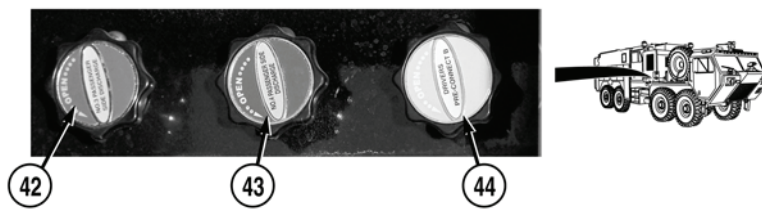

- 37. Put NO. 3 PASSENGER SIDE DISCHARGE (42), NO. 4 PASSENGER SIDE DISCHARGE (43) and DRIVERS PRE-CONNECT B (44) drain valves to closed position.

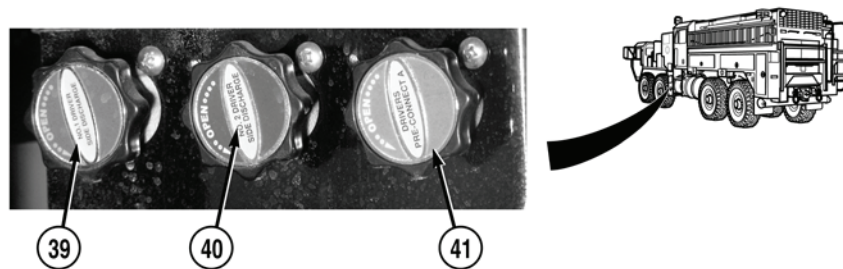

- 38. Put NO. 1 DRIVER SIDE DISCHARGE (39), NO. 2 DRIVER SIDE DISCHARGE (40) and DRIVERS PRE-CONNECT A (41) drain valves to closed position.

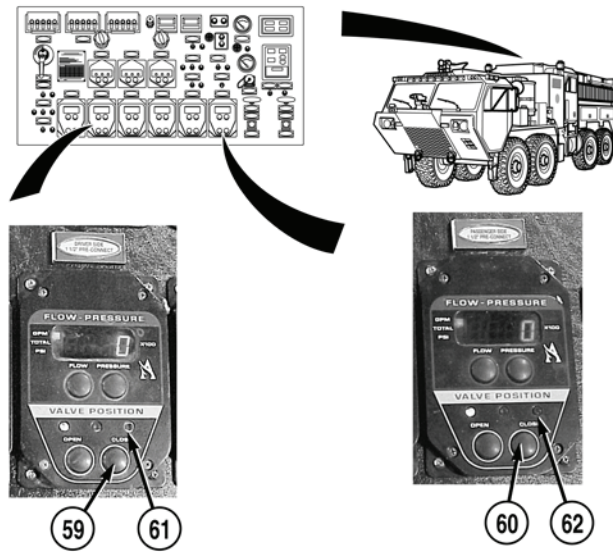

**NOTE**

Valves are completely closed when red indicator light illuminates.

39. Put DRIVER'S PRE-CONNECT A and DRIVERS PRE-CONNECT B valve control CLOSE buttons (59) and (60) until red indicator lights (61) and (62) illuminate.

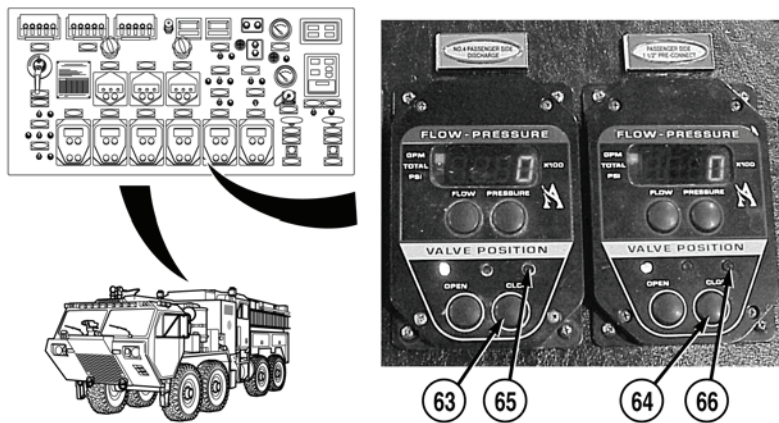

40. Put NO. 3 PASSENGER SIDE DISCHARGE and NO. 4 PASSENGER SIDE DISCHARGE valve control CLOSE buttons (63) and (64) until red indicator lights (65) and (66) illuminate.



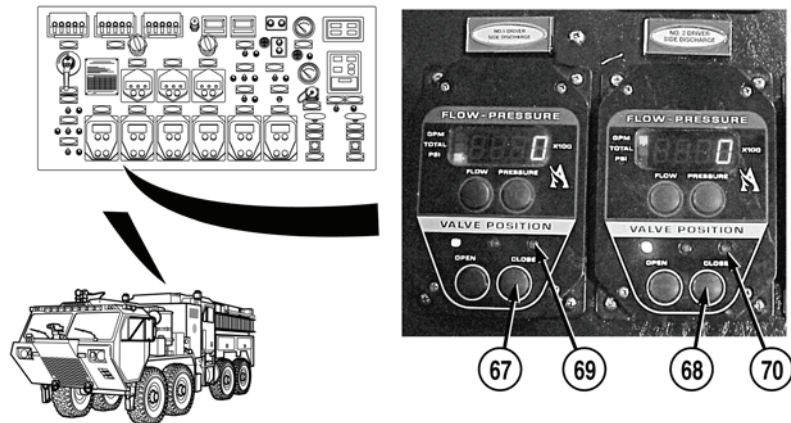

41. Put NO. 1 DRIVER SIDE DISCHARGE and NO. 2 DRIVER SIDE DISCHARGE valve control CLOSE buttons (67) and (68) until red indicator lights (69) and (70) illuminate.

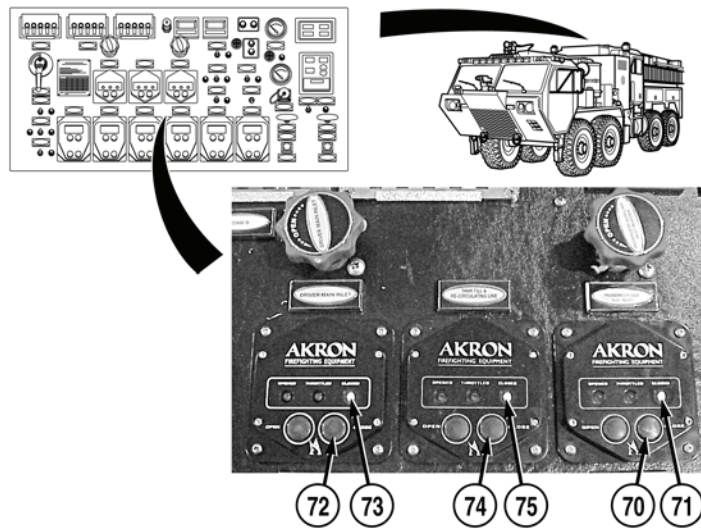

42. Push PASSENGER SIDE AUX. INLET valve control CLOSE button (70) until red indicator light (71) illuminates.
43. Push DRIVER MAIN INLET valve control CLOSE button (72) until red indicator light (73) illuminates.
44. Push TANK FILL & RE-CIRCULATING LINE valve control CLOSE button (74) until red indicator light (75) illuminates.

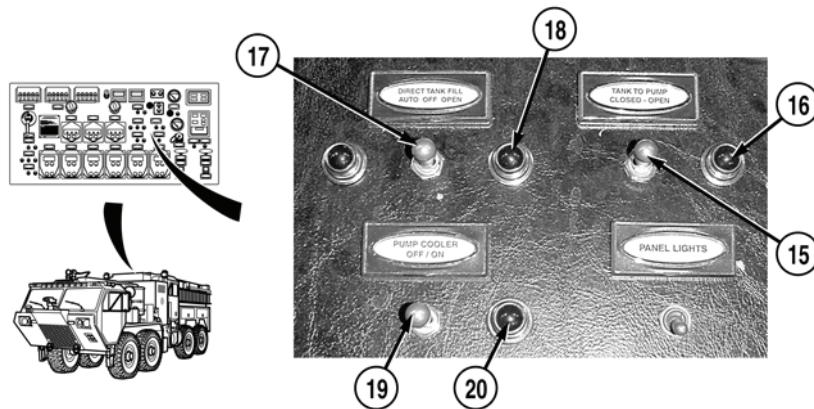

- 45. Put PUMP COOLER switch (19) to OFF position. Indicator light (20) will go out.
- 46. Put DIRECT TANK FILL switch (17) to OFF position. Indicator light (18) will go out.
- 47. Put TANK TO PUMP switch (15) to CLOSED position. Indicator light (16) will go out.

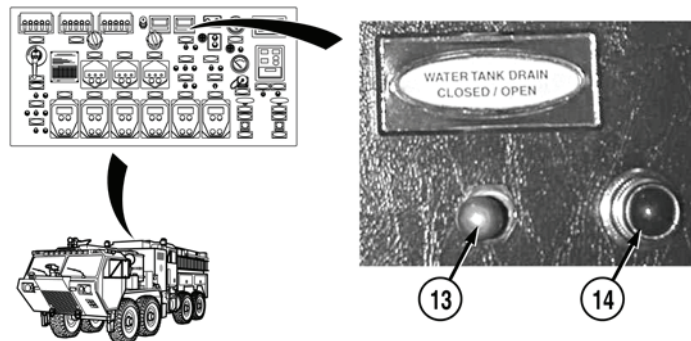

- 48. Put WATER TANK DRAIN switch (13) to CLOSED position. Indicator light (14) will go out.

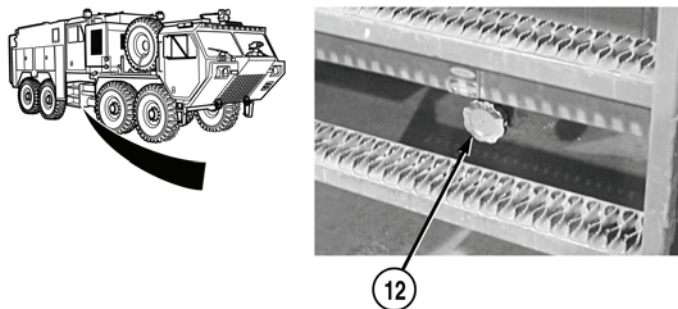

- 49. Put MASTER DRAIN valve (12) to CLOSED position.

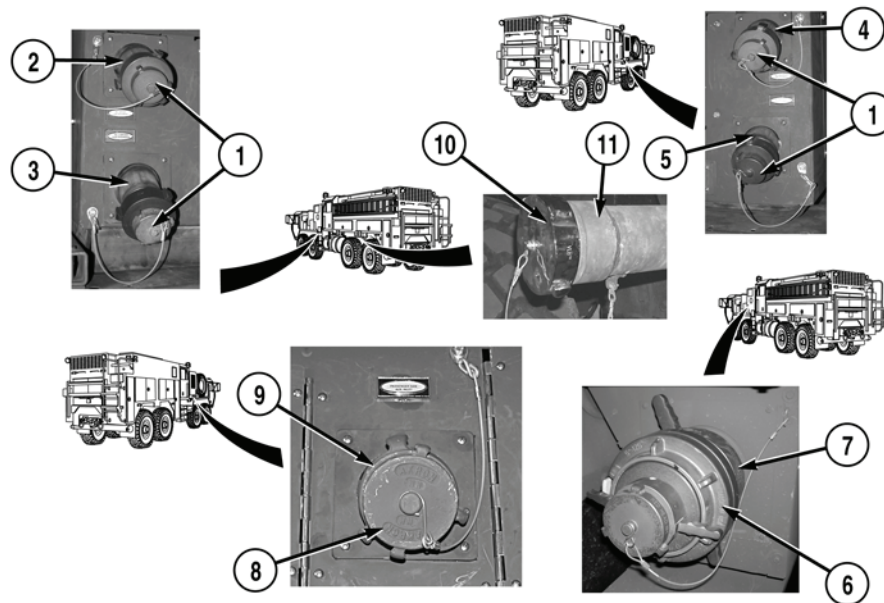

50. Install caps (1) on NO. 1 DRIVER SIDE DISCHARGE (2), NO. 2 DRIVER SIDE DISCHARGE (3), NO. 3 PASSENGER SIDE DISCHARGE (4), and NO. 4 PASSENGER SIDE DISCHARGE (5).
51. Install cap (6) on main inlet (7).
52. Install cap (8) on PASSENGER SIDE AUX. INLET (9).
53. Install cap (10) on DIRECT TANK FILL inlet (11).
54. Remove driver side crew cab access steps (WP 0514) and stow in crew cab.

#### END OF TASK

#### PREPARATION FOR SHIPMENT

1. Perform Pump and Plumbing Blow-Out Procedures if required (WP 0044).
2. Report all deficiencies to Supervisor.
3. Drain all air tanks (TM 9-2320-347-10).

#### END OF TASK

#### END OF WORK PACKAGE



---

**OPERATOR MAINTENANCE**  
**PUMP AND PLUMBING BLOW-OUT PROCEDURES**

---

**NOTE**

This procedure is to be used when preparing the TFFT for storage and shipment or post operation in cold environment.

1. Complete mission.

**WARNING**



**Make sure truck is parked in a location where personnel and other equipment will be protected from water spraying out of the discharges and drains.**

2. Position truck in a suitable location to drain and spray out remaining water.
3. Apply parking brake (TM 9-2320-347-10).

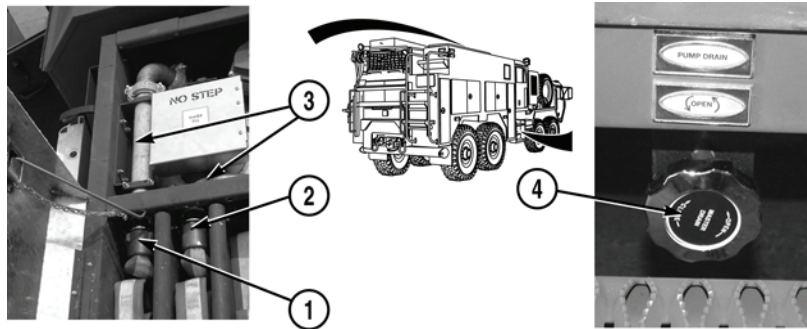

**WARNING**



**Driver side pre-connect A and B hoses must be disconnected prior to performing blow-out procedure. Hoses may become pressurized, causing injury to personnel and/or damage to equipment.**

4. Disconnect driver side pre-connect A hose (1) and driver side pre-connect B hose (2) from two pre-connects (3).
5. Drain water tank (WP 0029).
6. Open MASTER DRAIN valve (4).

**NOTE**

Perform Step (7) only if foam system and foam agent tanks are going to be left in a "dry condition".

7. Drain and flush foam agent from foam tank (WP 0032).

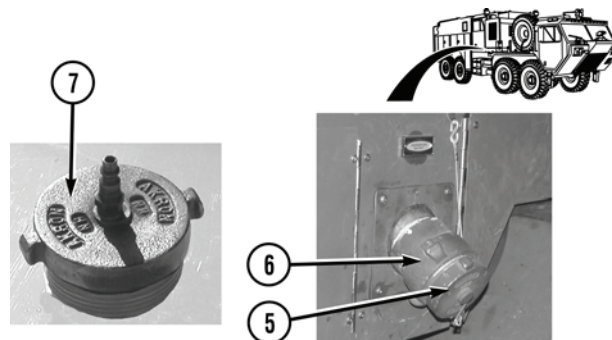

8. Remove cap (5) from PASSENGER SIDE AUXILIARY INLET (6).
9. Remove blow-out adapter (7) from stowage and install on PASSENGER SIDE AUXILIARY INLET (6).

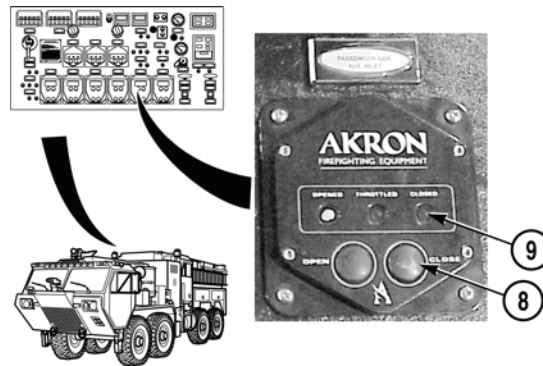

10. Make sure PASSENGER SIDE AUXILIARY INLET valve control (8) is in CLOSED position. Indicator light (9) will illuminate.
11. Make sure all valves are closed.

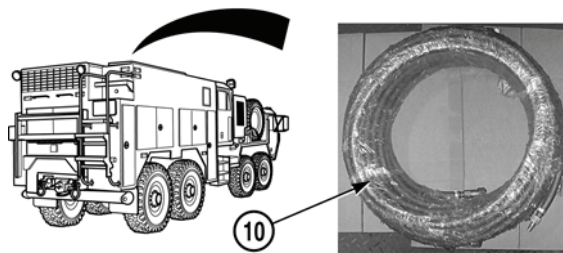

12. Remove air hose (10) from stowage.

### **WARNING**



- **Be careful when using high air pressure. Make sure connections and seals are tight before applying pressure. High air pressure can blow out parts, hoses, or debris with force. Explosive force can cause damage to equipment or injury to personnel.**
  - **Wear single hearing protection (earplugs or equivalent) while working around compressed air. Failure to comply may result in damage to your hearing. Seek medical aid should you suspect a hearing problem.**
  - **Air pressure should not exceed 50 psi (345 kPa) during blow-out procedure. Failure to comply may result in damage to equipment. Failure to comply may result in injury to personnel.**
13. Connect air hose (10) to blow-out adapter (7) on PASSENGER SIDE AUXILIARY INLET (6) and regulated air supply.
  14. If using vehicle for air supply, start vehicle engine (TM 9-2320-347-10).

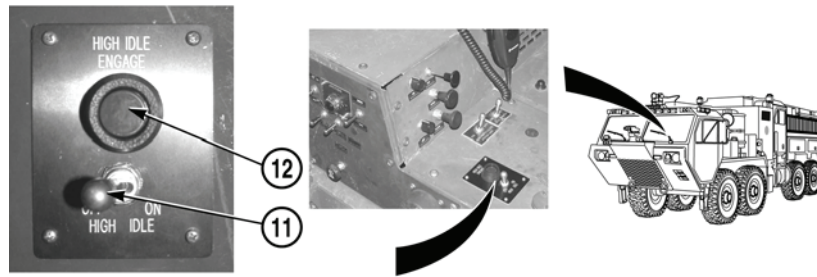

15. Put HIGH IDLE switch (11) in ON position. Indicator light (12) will illuminate.

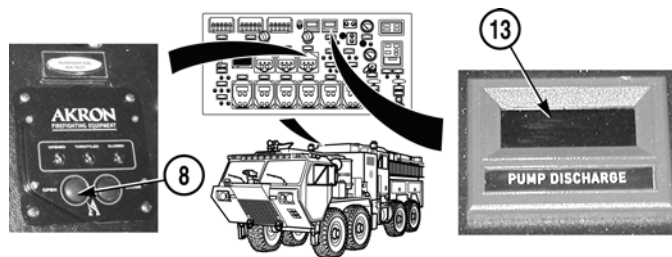

16. Slowly open PASSENGER SIDE AUXILIARY INLET valve control (8) until pressure is present on PUMP DISCHARGE gauge (13).



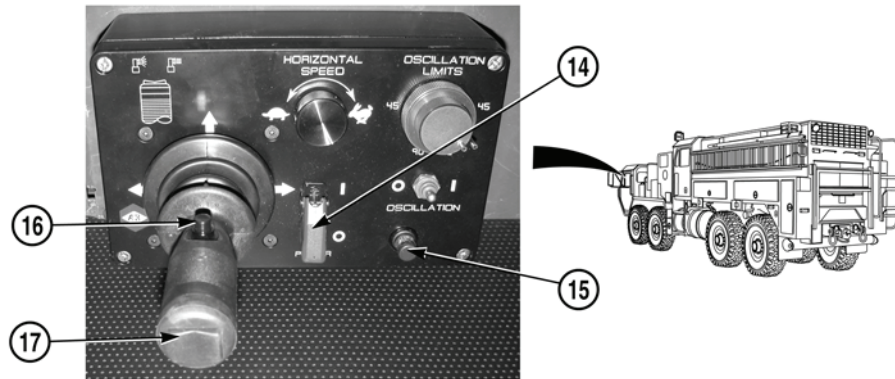

17. Put bumper turret power switch (14) in | (on) position. Indicator light (15) will illuminate.
18. Press and release bumper turret agent discharge button (16) on joystick control handle (17) to turn on and blow-out bumper turret and plumbing. Let pressure drop to zero. Press and release bumper turret agent discharge button (16) on joystick control handle (17) to turn off bumper turret.
19. Let pressure build up to 50 psi (345 kPa) and repeat Step (18). Put bumper turret power switch (14) to ○ (off) position. Check that indicator light (15) goes out.

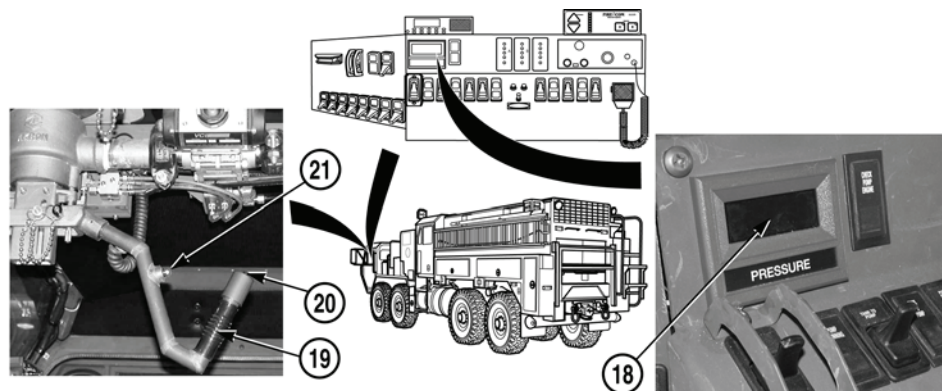

20. Let pressure build up to 50 psi (345 kPa) on pump PRESSURE gauge (18). With a firm grip on control handle (19), push and release button (20) to engage roof turret. Indicator light (21) will illuminate.
21. Let pressure drop to zero. Press and release agent discharge button (20) to turn roof turret to off. Check that indicator light (21) goes out.
22. Repeat Steps (20) and (21).

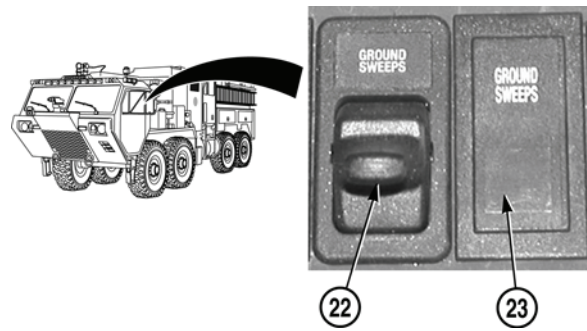

23. Let pressure build up to 50 psi (345 kPa) on pump PRESSURE gauge (18). Put GROUND SWEEPS switch (22) in on position. Indicator light (23) will illuminate.
24. Let pressure drop to zero. Put GROUND SWEEPS switch (22) in off position. Check that indicator light (23) goes out.
25. Repeat Steps (23) and (24).

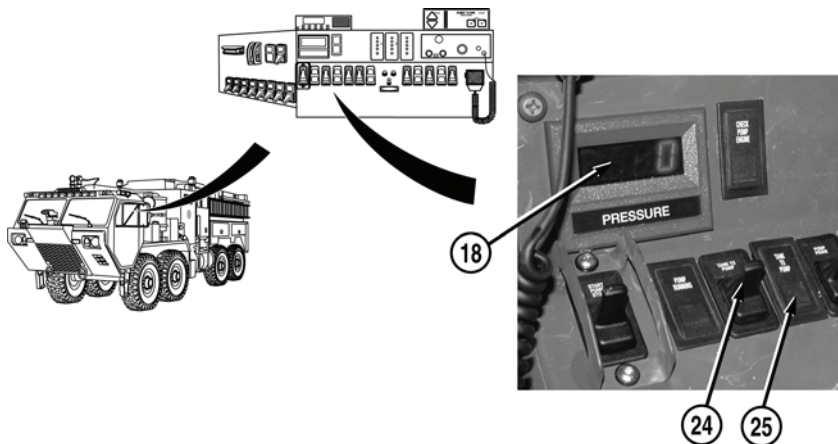

26. Let pressure build up to 50 psi (345 kPa) on pump PRESSURE gauge (18). Put TANK TO PUMP switch (24) in open position. Indicator light (25) will illuminate.
27. Let pressure drop to zero. Put TANK TO PUMP switch (24) in closed position. Check that indicator light (25) goes out.
28. Repeat Steps (26) and (27).

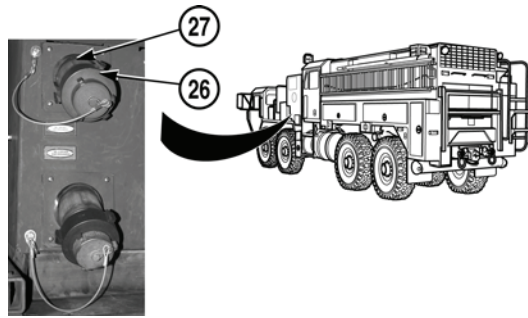

29. Remove cap (26) from NO. 1 DRIVER SIDE DISCHARGE (27).

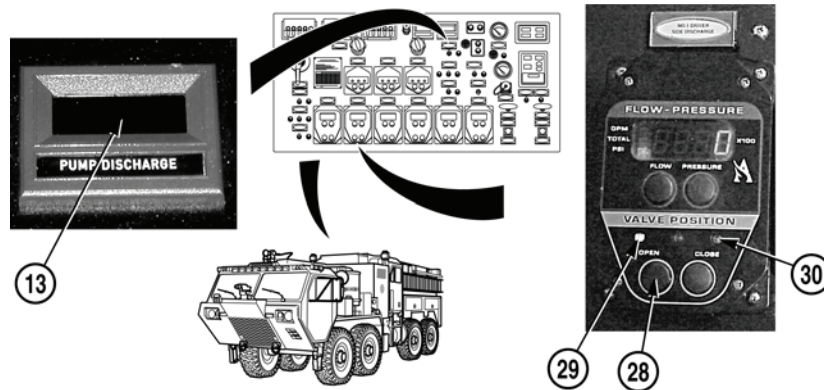

30. Let pressure build up to 50 psi (345 kPa) on PUMP DISCHARGE gauge (13). Put NO. 1 DRIVER SIDE DISCHARGE valve control (28) to ON position. Indicator light (29) will illuminate.
31. Let pressure drop to zero. Put NO. 1 DRIVER SIDE DISCHARGE valve control (28) in CLOSE position. Indicator light (30) will illuminate.
32. Repeat Steps (30) and (31).
33. Install cap (26) on NO. 1 DRIVER SIDE DISCHARGE (27).
34. Repeat Steps (29) through (33) for NO. 2, NO. 3, and NO. 4 SIDE DISCHARGES.

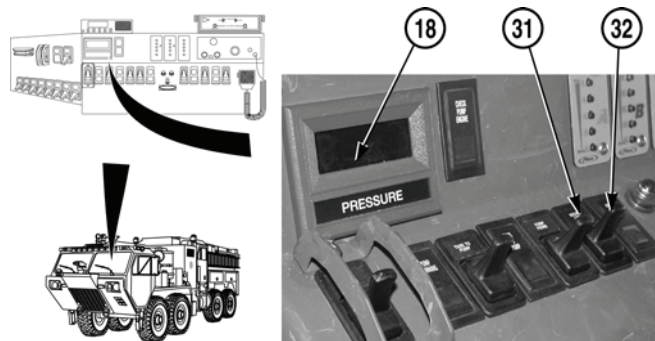

35. Let pressure build up to 50 psi (345 kPa) on pump PRESSURE gauge (18). Put PUMP COOLER switch (31) in open position. Indicator light (32) will illuminate.
36. Let pressure drop to zero. Put PUMP COOLER switch (31) in closed position. Check that indicator light (32) goes out.

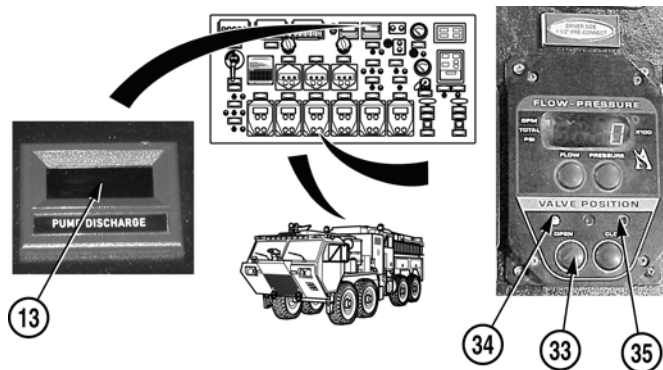

### **WARNING**



**Driver side pre-connect A and B hoses must be disconnected prior to performing blow-out procedure. Hoses may become pressurized causing injury to personnel and/or damage to equipment.**

37. Let pressure build up to 50 psi (345 kPa) on PUMP DISCHARGE gauge (13). Put DRIVER SIDE PRE-CONNECT A (33) valve control in OPEN position. Indicator light (34) will illuminate.
38. Let pressure drop to zero. Put DRIVER SIDE PRE-CONNECT A (33) in CLOSED position. Indicator light (35) will illuminate.
39. Repeat Steps (37) and (38).
40. Repeat Steps (37) through (39) for DRIVER SIDE PRE-CONNECT B.

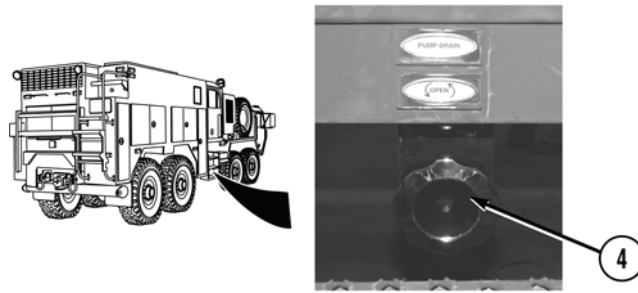

41. Let pressure build up to 50 psi (345 kPa) on PUMP DISCHARGE gauge (13). Open MASTER DRAIN valve (4).
42. When water stops draining from MASTER DRAIN valve (4), close MASTER DRAIN valve (4).

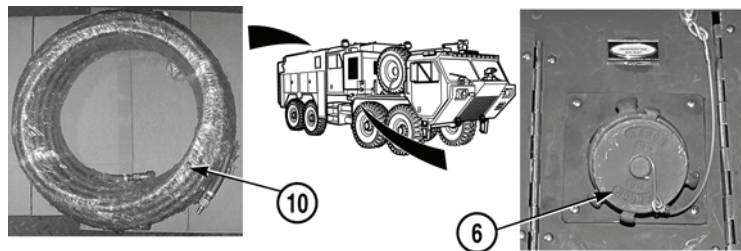

43. Disconnect air hose (10) from regulated air supply and blow-out adapter (7) on PASSENGER SIDE AUXILIARY INLET (6).
44. Stow air hose (10).

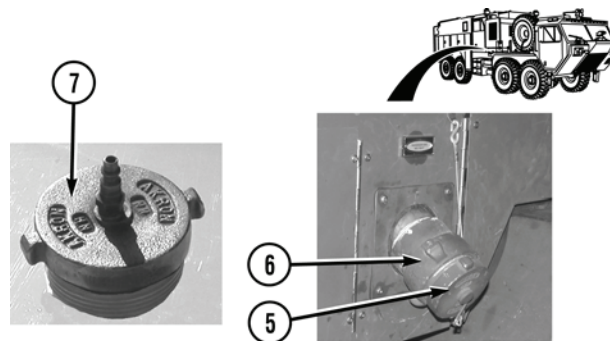

45. Remove and stow blow-out adapter (7) from PASSENGER SIDE AUXILIARY INLET (6).
46. Install cap (5) on PASSENGER SIDE AUXILIARY INLET (6).

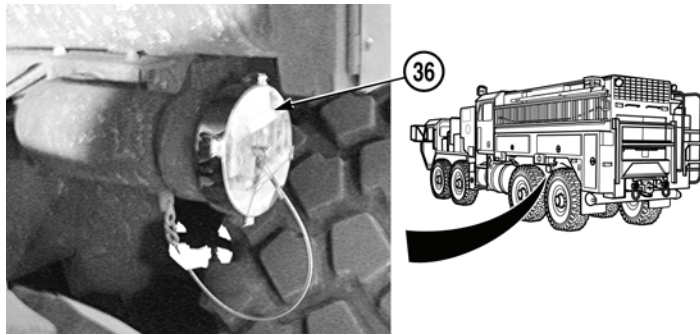

47. Remove cap (36) from DIRECT TANK FILL.

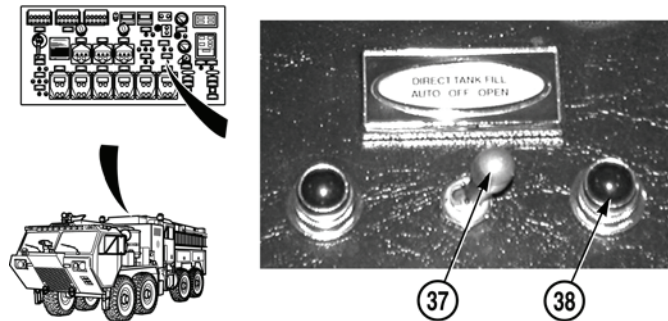

48. Put DIRECT TANK FILL switch (37) in OPEN position. Indicator light (38) will illuminate.

49. Allow tank to drain completely.

50. Put DRAIN TANK FILL switch (37) in OFF position. Check that indicator light (38) goes out.

51. Install cap (36) on DIRECT TANK FILL.

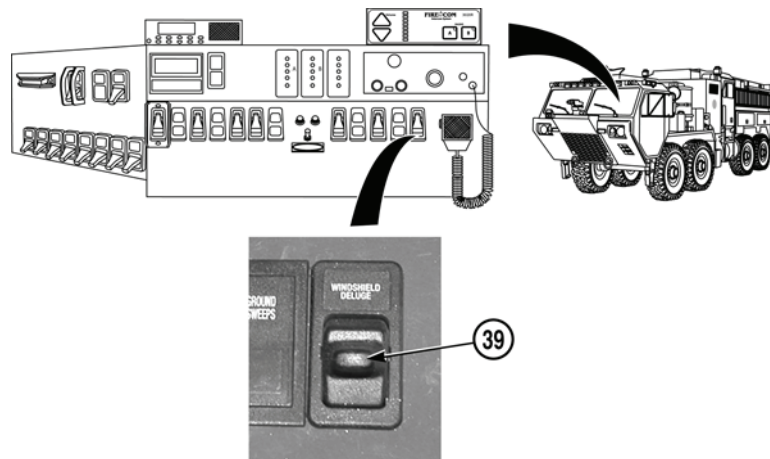

52. Turn ON vehicle windshield wipers (TM 9-2320-347-10).
53. Put WINDSHIELD DELUGE switch (39) in on position.
54. When water stops being discharged from two windshield deluge nozzles, put WINDSHIELD DELUGE switch (39) in off position.
55. Turn OFF vehicle windshield wipers (TM 9-2320-347-10).

**NOTE**

Do not open any FOAM AGENT SUPPLY valves. This will contaminate main water tank.

56. Make sure all caps have been installed.

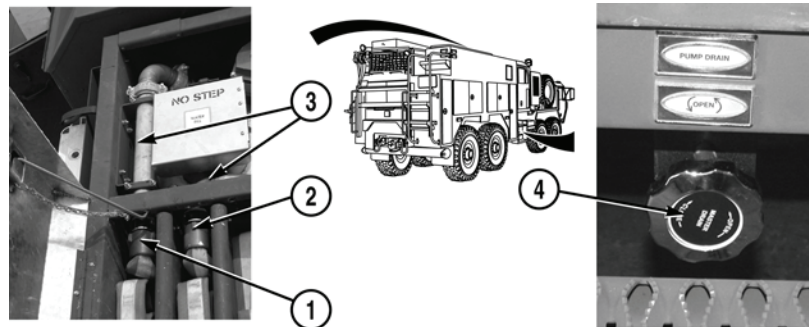

57. Connect driver side pre-connect A hose (1) and driver side pre-connect B hose (2) to two pre-connects (3).

**END OF TASK**

**END OF WORK PACKAGE**





---

**OPERATOR MAINTENANCE****OPERATION IN COLD ENVIRONMENT, -25 TO 32°F (-32 TO 0°C)**

---

**WARNING**

- Do not touch extremely cold metal below -26°F (-32°C). Bare skin may freeze to cold metal and cause injury to personnel.
- All valves should be opened and closed slowly during any procedure. Sudden changes in pressure may cause equipment to react faster than personnel can be alerted. Make sure surrounding personnel are aware of changes being made to settings on equipment. Failure to comply may result in injury or death to personnel and damage to equipment.
- **CARBON MONOXIDE (EXHAUST GAS) CAN CAUSE DEATH**
- Carbon monoxide is without color or smell, but can cause death. Breathing air with carbon monoxide produces symptoms of headache, dizziness, loss of muscular control, a sleepy feeling, and coma. Brain damage or death can result from heavy exposure. Carbon monoxide occurs in the exhaust fumes of fuel-burning heaters and internal combustion engines. Carbon monoxide can become dangerously concentrated under conditions of no ventilation. Precautions must be followed to ensure crew safety when the personnel heater or engine of any vehicle is operated for any purpose.
- **DO NOT** operate personnel heater or engine of vehicle in a closed place without proper ventilation.
- **DO NOT** drive any vehicle with inspection plates, cover plates, or engine compartment covers removed unless necessary for maintenance purposes.
- **BE ALERT** at all times during vehicle operation for exhaust odors and exposure symptoms. If either are present, **IMMEDIATELY VENTILATE** personnel compartments. If symptoms persist, remove affected crew to fresh air and keep warm. **DO NOT PERMIT PHYSICAL EXERCISE**. If necessary, give artificial respiration and get immediate medical attention. For artificial respiration, refer to FM 4-25.11.
- **BE AWARE** that the gas particulate filter unit or field protection mask for nuclear-biological-chemical protection **WILL NOT** offer safety from carbon monoxide poisoning.
- **THE BEST DEFENSE AGAINST CARBON MONOXIDE POISONING IS GOOD VENTILATION.**

 **CAUTION**

- **Watch cab instrument panel and pump operator's panel closely. If there are any unusual readings, check as soon as possible!**
- **All snow and ice should be removed from vehicle as soon as possible. Snow and ice may slow or stop movement of critical parts if allowed to pile up.**
- **Special care must be used during operations in extreme cold environment. In extreme cold, water can freeze almost instantly if not circulating. Hoses, plumbing, fittings, pipes, pumps, tanks, turrets, nozzles, drains, etc., can freeze and crack. Foam concentrate may get thick and stiff. Rubber may crack or break easily.**
- **TFFT has been designed to withstand temperatures down to -25°F (-32°C) for a period no longer than two hours. If either of these limits are exceeded, damage to equipment may result.**
- **During cold weather operations below 20°F (-7°C), Class A foam agent or Class B foam agent rated for at least -20°F (-29°C) must be used. Failure to comply may result in damage to equipment.**
- **TFFT must be kept in a protective environment (above 55°F [13°C]) when water is present in water tank and lines. Only store TFFT in an unprotected environment with temperatures below 32°F (0°C) if water system has been completely drained and blown out, and foam system has been completely drained. Failure to comply may result in damage to equipment.**
- **In cold weather, valves and drains may become frozen. Do not force valves and drains open or closed. It may be necessary to thaw valves and drains before attempting to open or close. Failure to comply may result in damage to equipment.**

**NOTE**

- A complete TFFT crew is required to perform firefighting operations.
- Refer to the following manuals for additional cold weather operation information:
  - Basic Cold Weather Operation Manual; FM 31-70
  - Northern Operations; FM 31-71
  - Operation and Maintenance of Ordnance Material in Cold Weather (0°F to -65°F [-18°C to -54°C]); FM 9-207
  - 8X8 Heavy Expanded Mobility Tactical Trucks (HEMTT) Operator's Manual; TM 9-2320-347-10
  - First Aid; FM 4-25.11

**PREPARATION FOR COLD WEATHER OPERATION**

1. Make sure truck has been parked in a warm shelter (55°F [13°C]) or higher prior to operations.

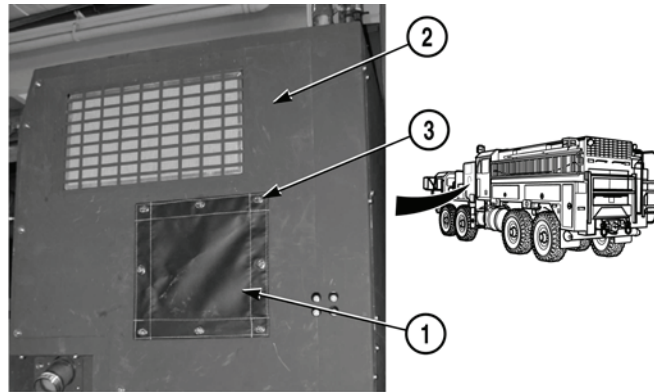

2. Install pump house cooling winterization cover (1) on left side pump house panel (2) with eight twist locks (3).
3. Make sure onboard water tank is full (WP 0020).
4. Make sure foam agent tanks are filled (WP 0031). Use Class A foam agent or a Class B foam agent rated for a minimum of -20°F (-29°C).

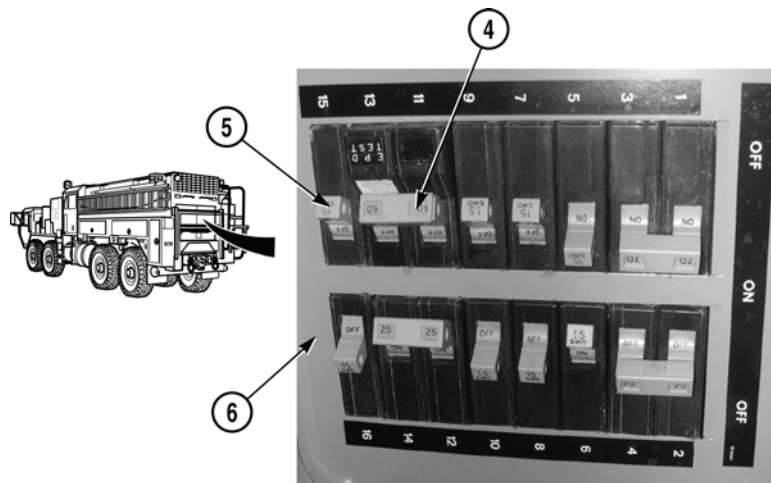

5. Start hydraulic generator (WP 0021).
6. Put water tank heater circuit breakers (CB11, CB13) (4) and pipe heaters circuit breaker (CB15) (5) on breaker box (6) to ON position.
7. Make sure water pump is drained and in a "dry condition" (WP 0032).
8. Make sure water pump and plumbing have been blown out (WP 0044).
9. Make sure all valves are closed and caps are installed.

**END OF TASK**

**OPERATING IN COLD WEATHER**

** CAUTION**

If main water pump is in a “Wet” (flooded) condition during cold weather operations, pump must be engaged and re-circulating water to prevent freezing of pump and plumbing. Failure to comply may result in damage to equipment.

**NOTE**

- Winterization package allows operation of water pump, foam system and body to -25°F (-32°C) for a period no longer than two hours. This package includes two diesel fired 27,300 BTU heaters, one inside pump compartment and one in rear compartment. Heaters automatically turn on at 39°F (+/- 2°F), (4°C [+/-1°C]), and turn off at 57°F (+/-3°F), (14°C [+/-1°C]).
- Two 2,250W heaters are installed in onboard water tank. Tank heaters automatically turn on at 40°F (4°C) and turn off at 60°F (16°C) when main circuit breakers (CB1 and CB3) and tank and pipe heater circuit breakers (CB11, CB13, and CB15) are turned ON and not tripped. Pump compartment is sealed to reduce heat loss. Critical piping is also heated and insulated.

1. Start vehicle engine (TM 9-2320-347-10).
2. Proceed to scene.

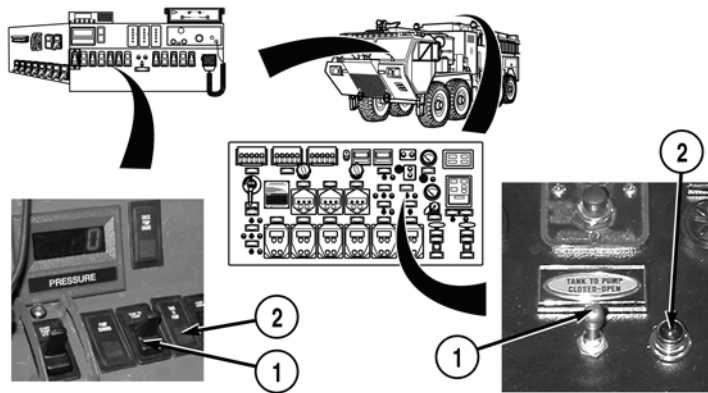

**NOTE**

When arriving at scene, proceed with Step (3).

3. Start water pump engine (WP 0022).
4. Put TANK TO PUMP switch (1) to OPEN position. Indicator light (2) will illuminate.
5. Prime water pump (WP 0023).

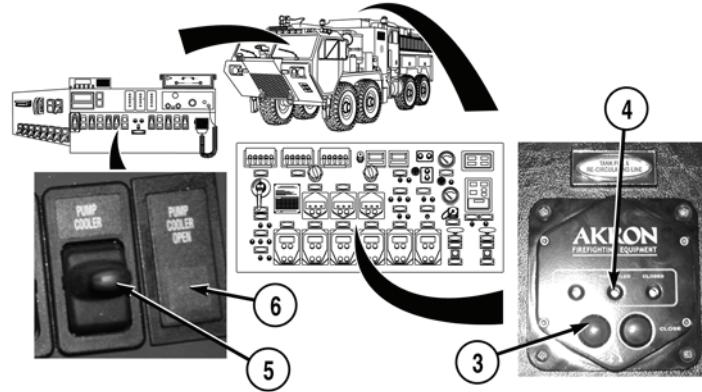

### NOTE

Perform Step (6) only if Steps (3) through (5) have been completed and pumping operations will be delayed, and, if mission exceeds a period of 10 minutes. Opening of TANK FILL & RE-CIRCULATING LINE valve control at pump operator's panel will re-circulate water to help prevent freezing.

6. Partially open TANK FILL & RE-CIRCULATING LINE valve control (3). Indicator light (4) will illuminate.
7. Put PUMP COOLER switch (5) to on position. Indicator light (6) will illuminate.

### NOTE

If performing Foam System Operation, make sure TANK FILL & RE-CIRCULATING LINE valve control is closed and PUMP COOLER valve is in OPEN position.

8. Perform desired discharge operation:
  - a. For "Pumping from Onboard Water Tank" Procedures (WP 0026).
  - b. For "Pump and Roll" Procedures (WP 0028).
  - c. For "Foam System Operations" (WP 0033) and (WP 0034).
9. Complete mission.

### CAUTION

- **Once mission is complete, make sure onboard water tank is empty. Stopping and starting pumping operations may allow water to freeze, causing damage to equipment. If water tank is not emptied, exposed components may freeze, causing damage to equipment.**
  - **Heaters in onboard water tank will automatically shut OFF when water level decreases to approximately 1/4 tank (below tank heater probes). Completely pump out all water from tank to prevent water from freezing.**
10. Pump out or discharge water until water tank is empty.

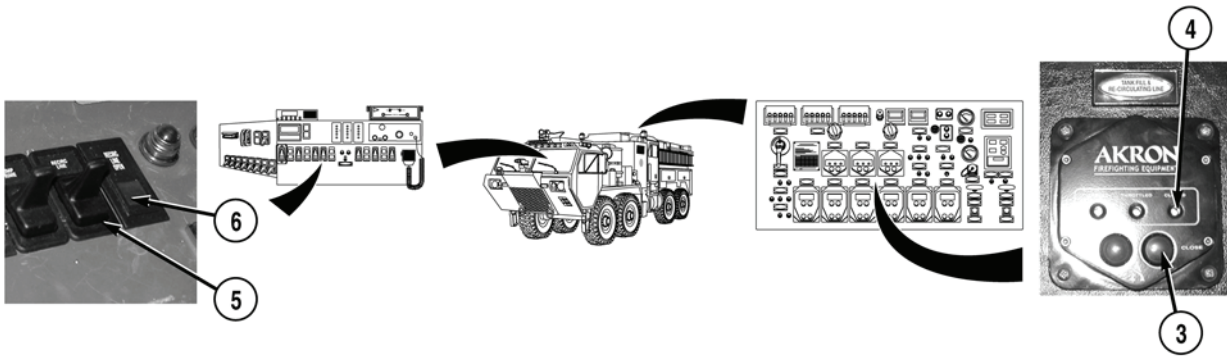

11. Put PUMP COOLER switch (5) to off position. Indicator light (6) will go out. Push TANK FILL & RE-CIRCULATING LINE valve control CLOSE button (3) until red indicator light (4) illuminates.
12. Shut off water pump engine (WP 0022).

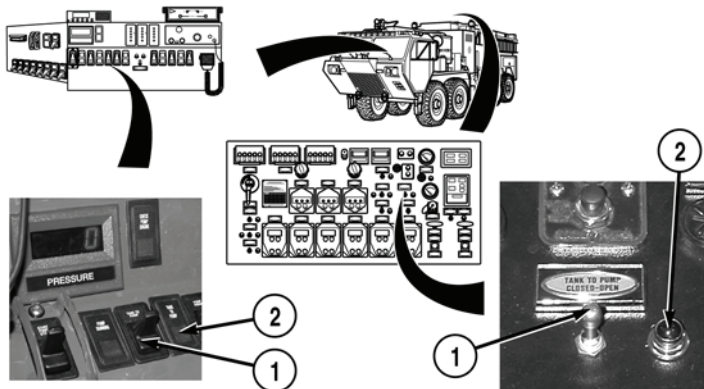

13. Put TANK TO PUMP switch (1) to CLOSED position. Indicator light (2) will go out.

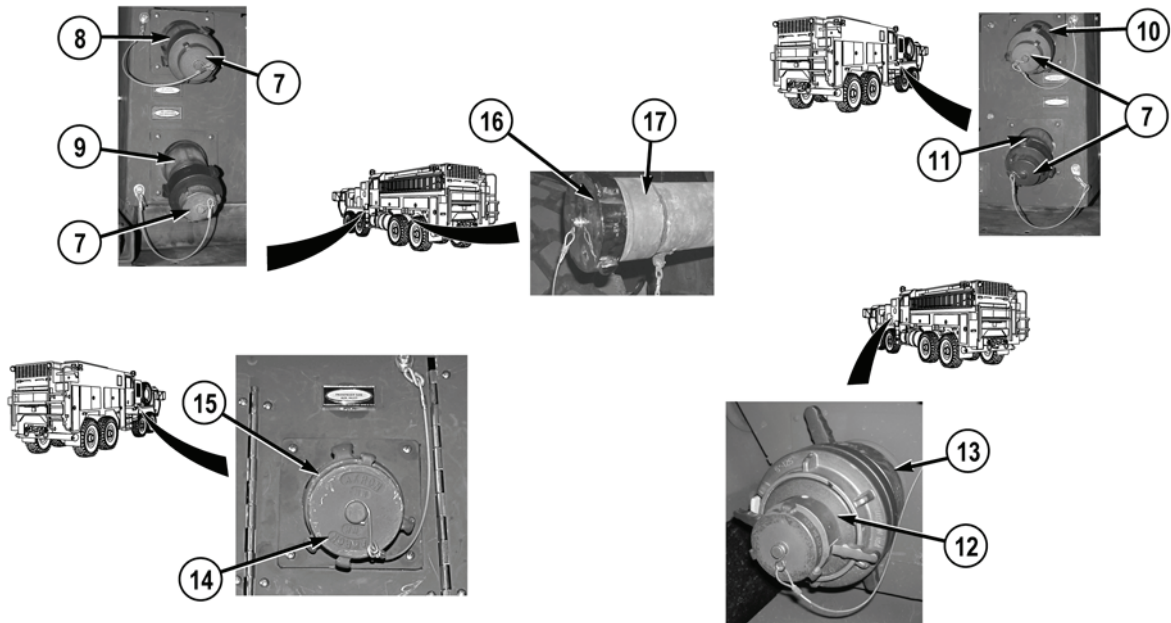

### NOTE

Do not open any foam agent supply valves. This will contaminate water tank.

14. Remove four caps (7) from NO.1 DRIVER SIDE DISCHARGE (8), NO. 2 DRIVER SIDE DISCHARGE (9), NO. 3 PASSENGER SIDE DISCHARGE (10), and NO. 4 PASSENGER SIDE DISCHARGE (11).
15. Remove cap (12) from main inlet (13).
16. Remove cap (14) from PASSENGER SIDE AUX. INLET (15).
17. Remove cap (16) from DIRECT TANK FILL inlet (17).

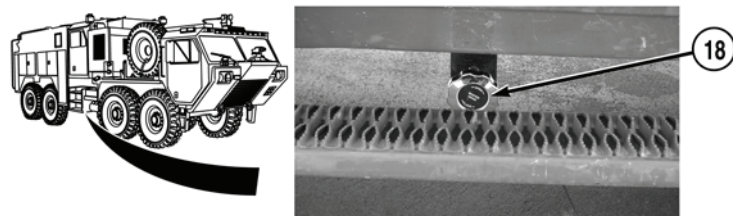

18. Put MASTER DRAIN valve (18) to OPEN position.

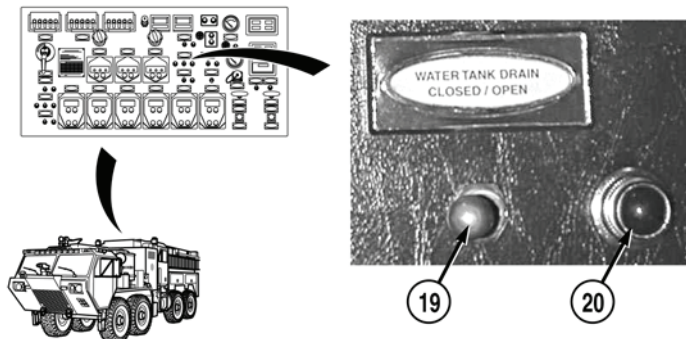

19. Put WATER TANK DRAIN switch (19) to OPEN position. Indicator light (20) will illuminate.

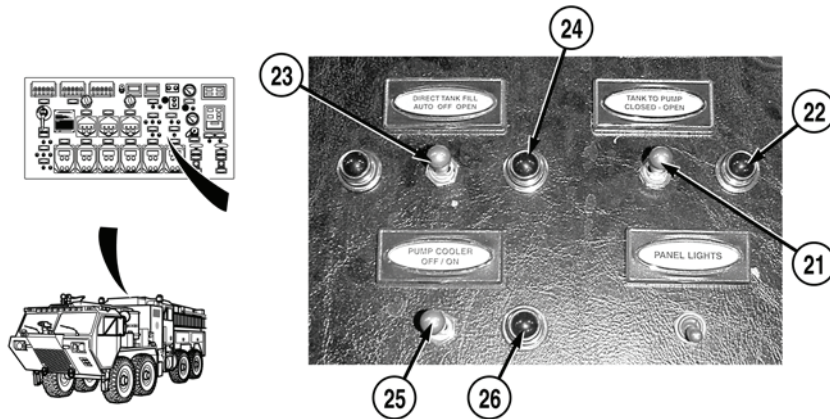

20. Put TANK TO PUMP switch (21) to OPEN position. Indicator light (22) will illuminate.

21. Put DIRECT TANK FILL switch (23) to OPEN position. Indicator light (24) will illuminate.

22. Put PUMP COOLER switch (25) to ON position. Indicator light (26) will illuminate.



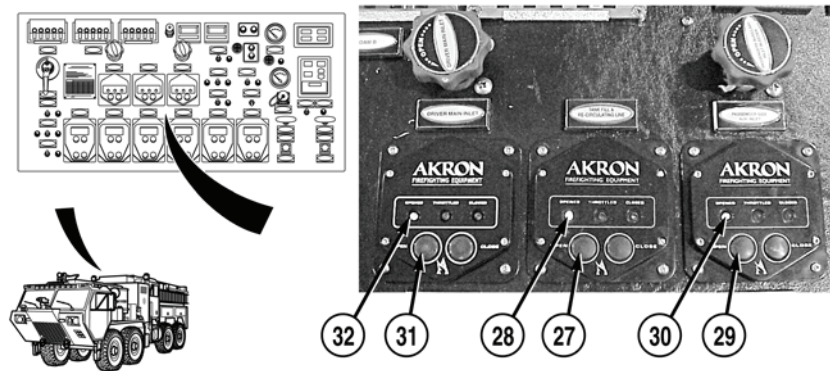

23. Push TANK FILL & RE-CIRCULATING LINE valve control OPEN button (27) until green indicator light (28) illuminates.
24. Push DRIVER MAIN INLET valve control OPEN button (29) until green indicator light (30) illuminates.
25. Push PASSENGER SIDE AUX. INLET valve control OPEN button (31) until green indicator light (32) illuminates.

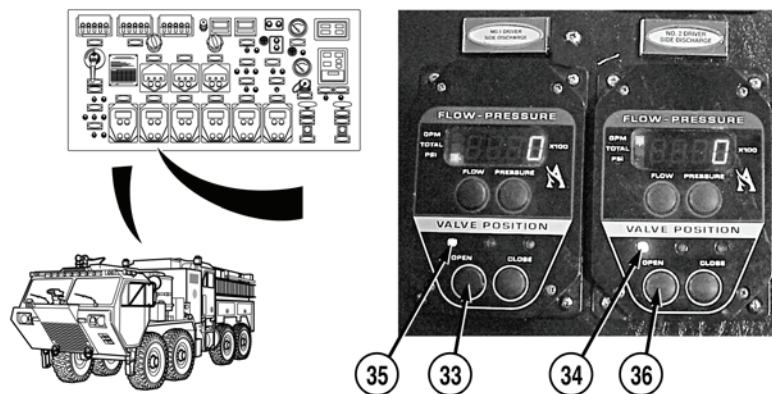

26. Push NO. 1 DRIVER SIDE DISCHARGE valve control OPEN button (33) and NO. 2 DRIVER SIDE DISCHARGE valve control OPEN button (34) until green indicator lights (35) and (36) illuminate.

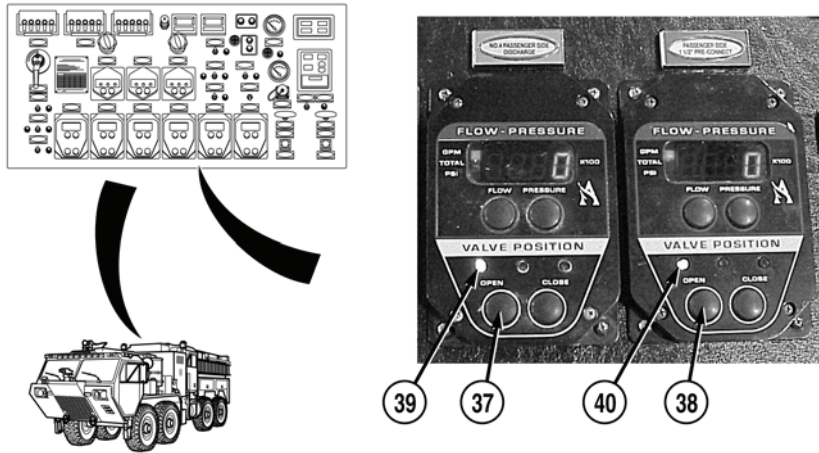

27. Push NO. 3 PASSENGER SIDE DISCHARGE (37) and NO. 4 PASSENGER SIDE DISCHARGE (38) valve control OPEN buttons until green indicator lights (39) and (40) illuminate.

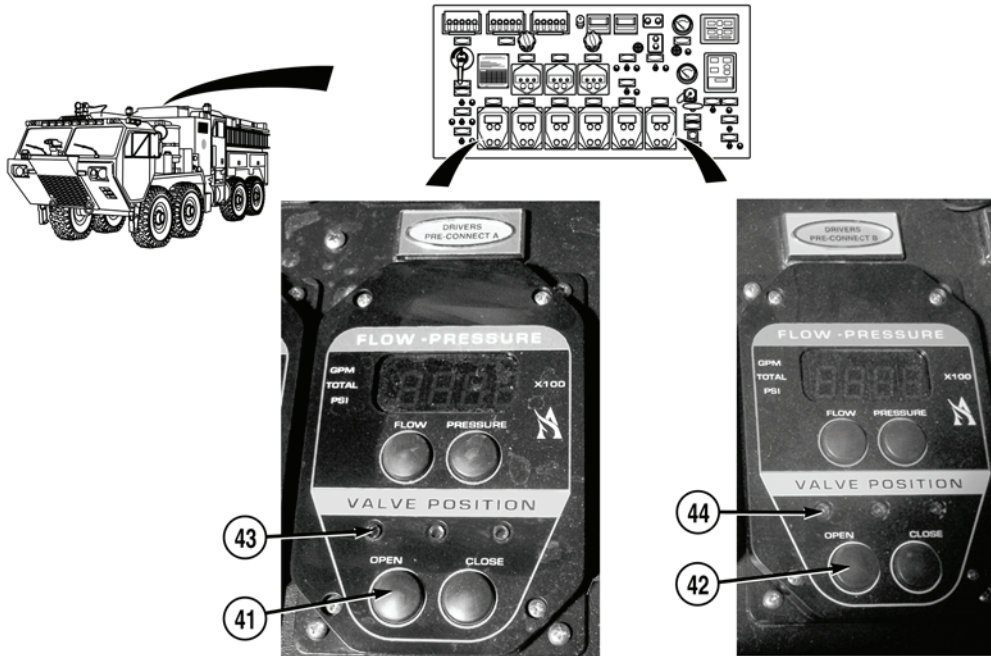

28. Push DRIVERS PRE-CONNECT A (41) and DRIVERS PRE-CONNECT B (42) valve control OPEN buttons until green indicator lights (43) and (44) illuminate.

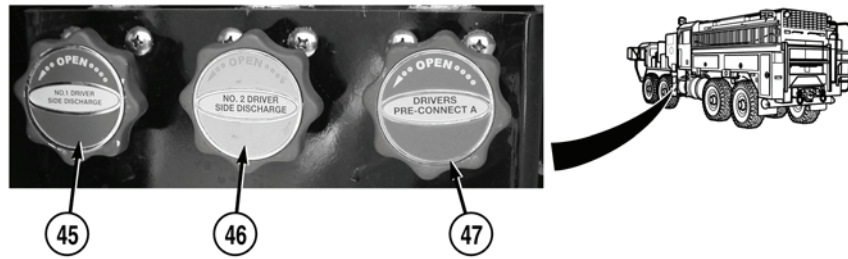

**NOTE**

Hand operated drain valves only open 1/4 turn.

29. Put NO. 1 DRIVER SIDE DISCHARGE (45), NO. 2 DRIVER SIDE DISCHARGE (46) and DRIVER PRE-CONNECT A (47) drain valves to open position.



30. Put NO. 3 PASSENGER SIDE DISCHARGE (48), NO. 4 PASSENGER SIDE DISCHARGE (49) and DRIVER PRE-CONNECT B (50) drain valves to open position.

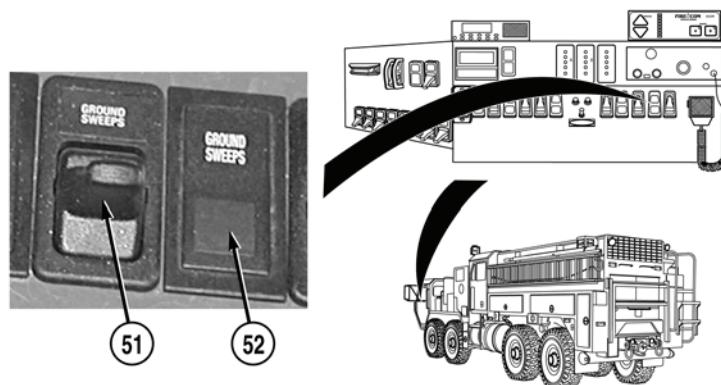

31. Put GROUND SWEEPS switch (51) to on position. Indicator light (52) will illuminate.

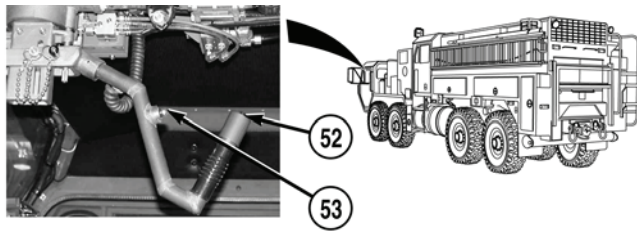

32. Push agent discharge button (52) to on position. Indicator light (53) will illuminate.

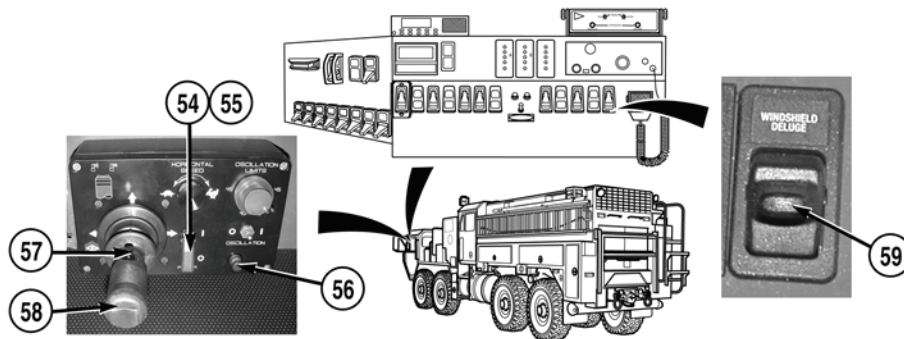

33. Lift power switch guard (54) and put power switch (55) to | (on) position. Indicator light (56) will illuminate.

34. Push and release agent discharge button (57) on front of joystick control handle (58) to begin discharge.

35. Put WINDSHIELD DELUGE switch (59) to on position and run for 15 to 30 seconds.

36. Allow water tank to drain.

37. Push and release agent discharge button (57) on front of joystick control handle (58) to stop discharge.

38. Put power switch (55) to ○ (off) position. Indicator light (56) will go out.

39. Push agent discharge button (52) to off position. Indicator light (53) will go out.

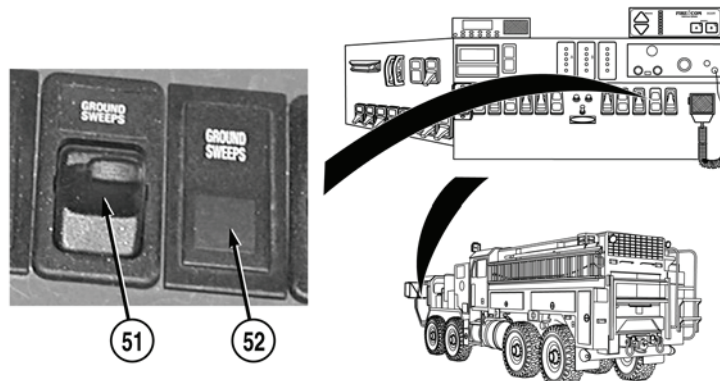

40. Put GROUND SWEEPS switch (51) to CLOSED position. Indicator light (52) will go out.



41. Put NO. 3 PASSENGER SIDE DISCHARGE (48), NO. 4 PASSENGER SIDE DISCHARGE (49) and DRIVER PRE-CONNECT B (50) drain valves to closed position.

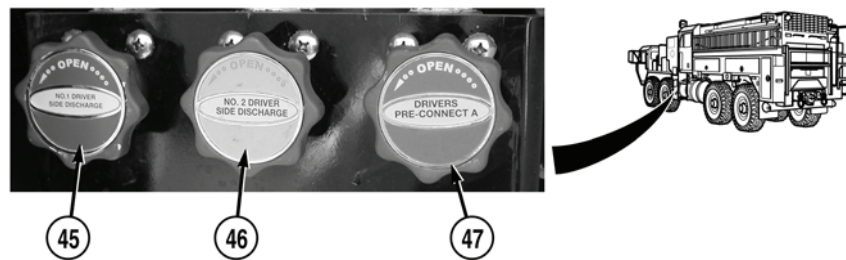

42. Put NO. 1 DRIVER SIDE DISCHARGE (45), NO. 2 DRIVER SIDE DISCHARGE (46) and DRIVER PRE-CONNECT A (47) drain valves to closed position.

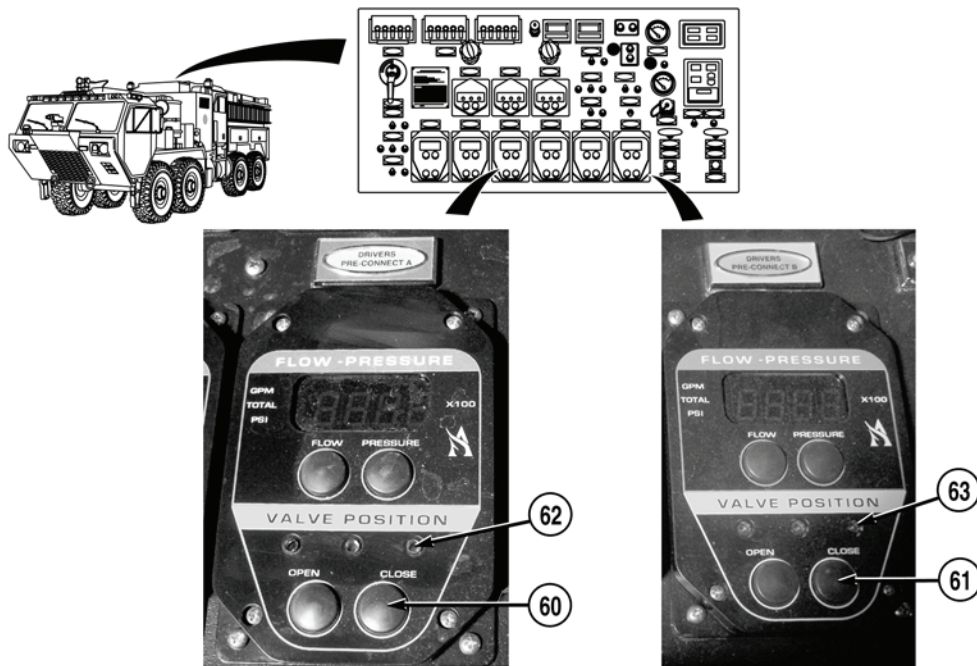

43. Push DRIVERS PRE-CONNECT A (60) and DRIVERS PRE-CONNECT B (61) valve control CLOSE buttons until red indicator lights (62) and (63) illuminate.

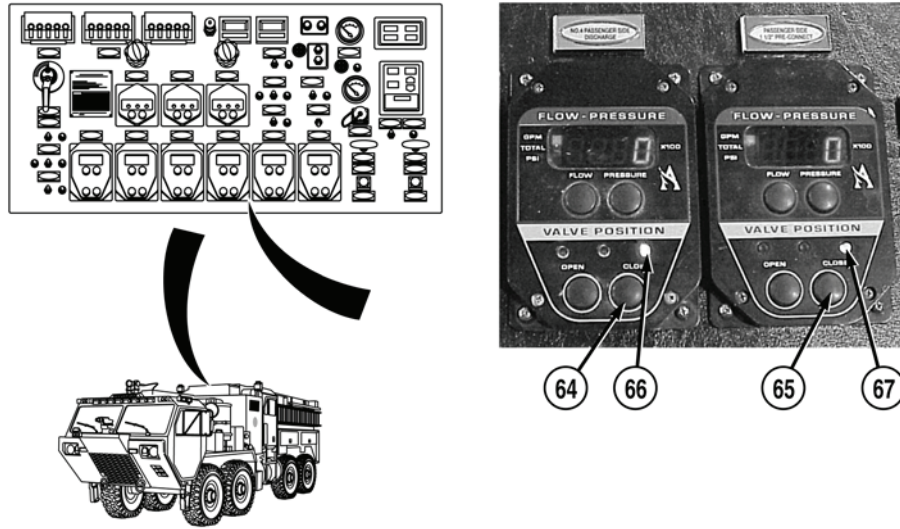

44. Put NO. 3 PASSENGER SIDE DISCHARGE (64) and NO. 4 PASSENGER SIDE DISCHARGE (65) valve control CLOSE buttons until red indicator lights (66) and (67) illuminate.

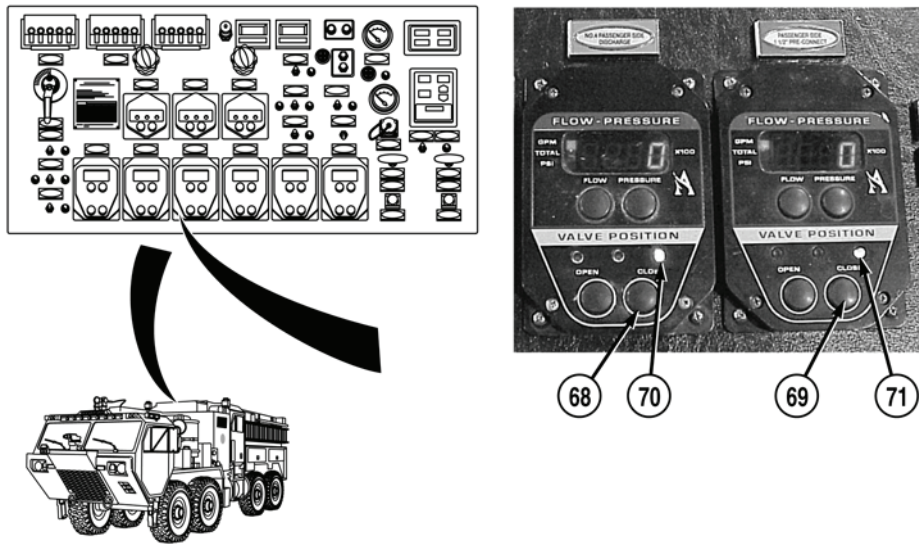

45. Put NO. 1 DRIVER SIDE DISCHARGE (69) and NO. 2 DIVER SIDE DISCHARGE (70) valve control CLOSE buttons until red indicator lights (71) and (72) illuminate.

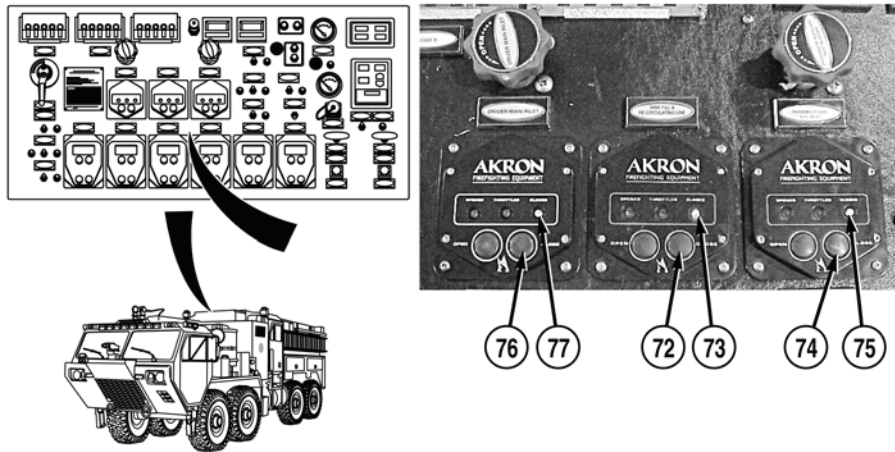

- 46. Push PASSENGER SIDE AUX. INLET valve control CLOSE button (72) until red indicator light (73) illuminates.
- 47. Push DRIVER MAIN INLET valve control CLOSE button (74) until red indicator light (75) illuminates.
- 48. Push TANK FILL & RE-CIRCULATING LINE valve control CLOSE button (76) until red indicator light (77) illuminates.

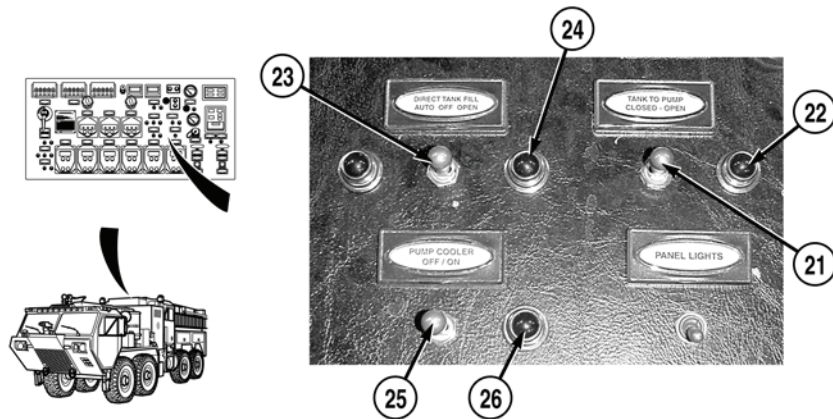

- 49. Put PUMP COOLER switch (25) to OFF position. Indicator light (26) will go out.
- 50. Put DIRECT TANK FILL switch (23) to OFF position. Indicator light (24) will go out.
- 51. Put TANK TO PUMP switch (21) to CLOSED position. Indicator light (22) will go out.

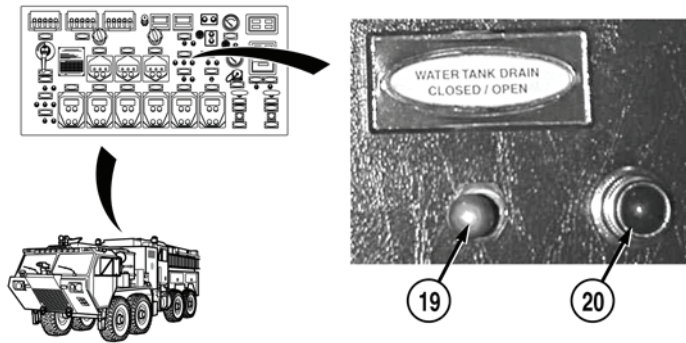

52. Put WATER TANK DRAIN switch (19) to CLOSED position. Indicator light (20) will go out.

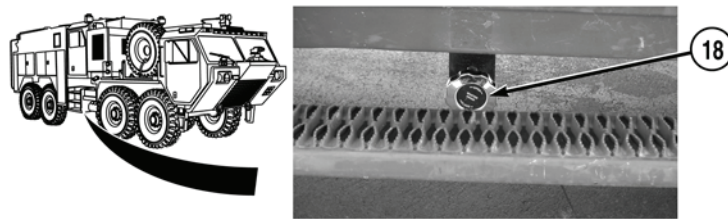

53. Put MASTER DRAIN valve (18) to CLOSED position.



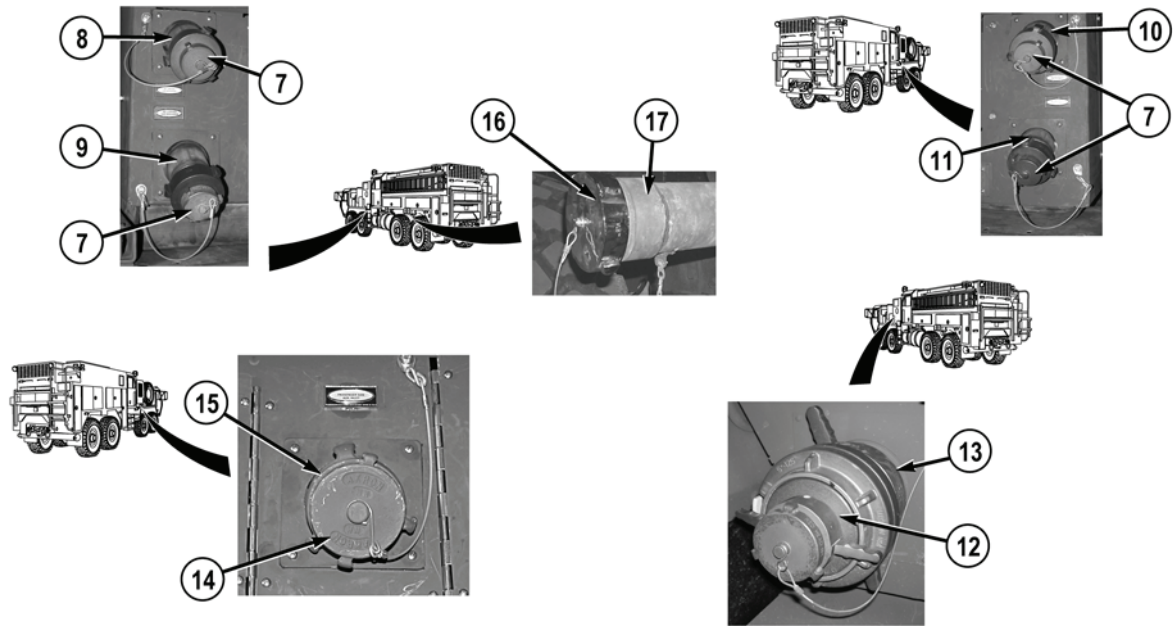

54. Install four caps (7) on NO. 1 DRIVER SIDE DISCHARGE (8), NO. 2 DRIVER SIDE DISCHARGE (9), NO. 3 PASSENGER SIDE DISCHARGE (10), and NO. 4 PASSENGER SIDE DISCHARGE (11).
55. Install cap (12) on main inlet (13).
56. Install cap (14) on PASSENGER SIDE AUX. INLET (15).
57. Install cap (16) on DIRECT TANK FILL inlet (17).

**END OF TASK**

---

**POST COLD WEATHER OPERATION** **CAUTION**

Once pumping operations have been completed, park vehicle in a warm shelter 55°F (13°C) as soon as possible to prevent water from freezing and causing damage to equipment.

1. Park vehicle in warm shelter as soon as possible (TM 9-2320-347-10).
2. Shut off vehicle engine (TM 9-2320-347-10).

 **CAUTION**

If compartment heaters are operating, DO NOT turn off the 24 V battery disconnect switch, as this will disable the heaters. The heaters will shut off automatically after they complete a cool-down cycle (5-10 minutes). At that time the 24V battery disconnect switch can be turned off. Failure to comply may result in damage to heaters.

**NOTE**

Perform Step (3) if foam system flush was used and not flushed at scene.

3. Perform foam system flush (WP 0032).
4. Perform Post Operation procedures (WP 0041).

 **CAUTION**

It is recommended during cold weather conditions to leave main water pump in a “dry condition” and foam system charged with Class A foam agent or Class B foam agent rated for a minimum of -20°F (-29°C) to prevent water and foam from freezing and causing damage to equipment.

5. Make sure foam tanks are filled with Class A foam agent or Class B foam agent rated for a minimum of -20°F (-29°C) (WP 0031).
6. Make sure water pump and plumbing have been blown out (WP 0044).

**END OF TASK****END OF WORK PACKAGE**

---

**OPERATOR MAINTENANCE**  
**STOWAGE AND DATA PLATE GUIDE**

---

**SCOPE**

This work package shows locations for data plates, decals, and stencils that are to be in place on the M1142 series vehicle.

**GENERAL**

The figures on the next pages show the location of metal signs, decals, and stencils used on the vehicle. Most of these signs and stencils contain cautions or information needed to operate the vehicle safely. For stowage locations of Components of End Items (COEI) and Basic Issue Items (BII), refer to WP 0047.

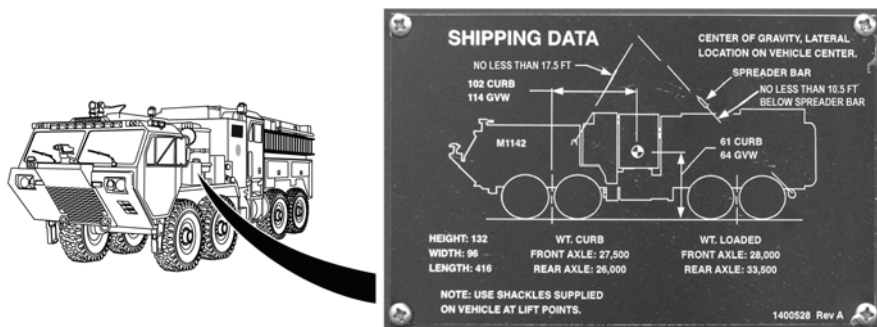
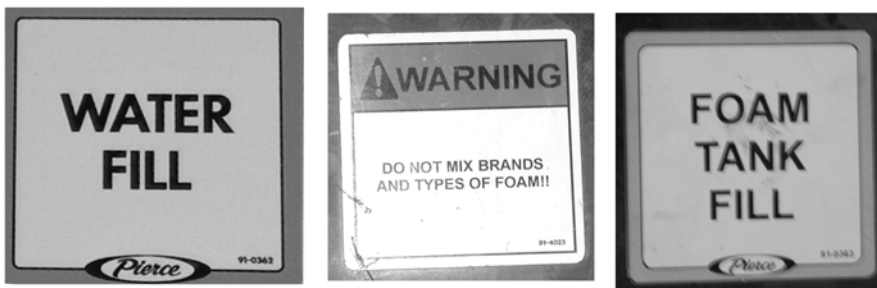

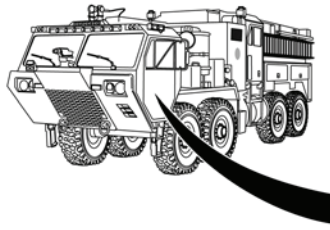

**⚠ DANGER**  
OCCUPANTS MUST BE SEATED AND BELTED WHEN APPARATUS IS IN MOTION

**⚠ DANGER**  
THIS VEHICLE HAS A SEATING CAPACITY OF 6 PERSONNEL CARRYING ADDITIONAL PERSONNEL MAY RESULT IN DEATH OR SERIOUS INJURY.

**⚠ WARNING**  
When entering or off vehicle, always:  
• Use caution.  
• Use proper and handholds.  
• Do not lean or sit on edge of vehicle with center line handholds held in their function hole.  
• Use proper handholds and address straps.  
• Use correct posture when seat, by or through a handhold or when using any device.  
Death or serious injury may result.

**⚠ CAUTION**  
SERIOUS HEALTH HAZARD: CERTAIN CARBON MONOXIDE (CO) LEVELS MAY BE PRESENT IN THIS VEHICLE. SERIOUS HEALTH HAZARD: CERTAIN CARBON MONOXIDE (CO) LEVELS MAY BE PRESENT IN THIS VEHICLE. SERIOUS HEALTH HAZARD: CERTAIN CARBON MONOXIDE (CO) LEVELS MAY BE PRESENT IN THIS VEHICLE.

**⚠ CAUTION**  
SERIOUS HEALTH HAZARD: CERTAIN CARBON MONOXIDE (CO) LEVELS MAY BE PRESENT IN THIS VEHICLE. SERIOUS HEALTH HAZARD: CERTAIN CARBON MONOXIDE (CO) LEVELS MAY BE PRESENT IN THIS VEHICLE. SERIOUS HEALTH HAZARD: CERTAIN CARBON MONOXIDE (CO) LEVELS MAY BE PRESENT IN THIS VEHICLE.

CAUTION

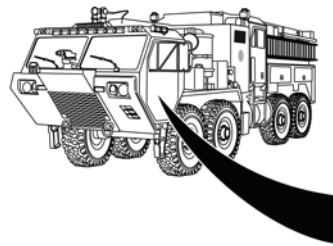

**TRUCK TACTICAL FIREFIGHTING**

MODEL NO. **M1142**

SERIAL NO. **TOTGL4Y136S087908**

REG. NO. **NKOMGP**

NSN NO. **4210-01-484-1035**

DATE OF MFG. **12/2006**

CONTRACT NO. **W56HJV02C-0457**

Manufactured Exclusively For US ARMY TACOM, INC.  
MILITARY SPECIFICATION: **FM 1142**

DATE OF MANUFACTURE	MANUFACTURING PLANT	COLOR
01/2007	AMERICAN TRUCK COMPANY	COLON: LIME GREEN
DATE OF VEHICLE REGISTRATION	REG. NO.	PARTY NO. PREFIX
01/2007	NKOMGP	PARTY NO. PREFIX
DATE OF PURCHASE	DATE OF PURCHASE	COLOR: FEDERAL STD. COLOR
01/2007	01/2007	30000
COMPONENTS OF THE CHASSIS CAN BE IDENTIFIED BY SERIAL NUMBER, BODY NUMBER, VIN, AND LICENSE PLATE NUMBER. THESE IDENTIFIERS ARE LOCATED ON THE FRONT OF THE CHASSIS AND ON THE REAR OF THE BODY. THE IDENTIFIERS ARE LOCATED ON THE FRONT OF THE CHASSIS AND ON THE REAR OF THE BODY. THE IDENTIFIERS ARE LOCATED ON THE FRONT OF THE CHASSIS AND ON THE REAR OF THE BODY.		
VEHICLE IDENTIFICATION NO. (VIN)		
VEHICLE TYPE: <b>FIREFIGHTING TRUCK</b>		

VEHICLE IDENTIFICATION NO. (VIN)	VEHICLE TYPE
1250000000000000000	FIREFIGHTING TRUCK

VEHICLE IDENTIFICATION NO. (VIN)	VEHICLE TYPE
1250000000000000000	FIREFIGHTING TRUCK

**PUMP LUBRICATION**  
CHECK OIL LEVEL DAILY TO INSURE PROPER OPERATION AND TO PREVENT OVERHEATING. DO NOT OVERFILL. OIL LEVELS SHOULD BE MAINTAINED AT THE UPPER LIMIT OF THE OIL LEVEL INDICATOR. SEE MANUAL FOR OIL SPECIFICATIONS AND RECOMMENDATIONS.

**PERFORMANCE**  
150 PSI  
100 PSI  
50 PSI

**CAUTION**  
WHEN OPENING CO2 BURNERS, ALWAYS USE PROPER TECHNIQUE TO PREVENT BURNING. SEE OIL MANUAL FOR PROPER OPERATION.

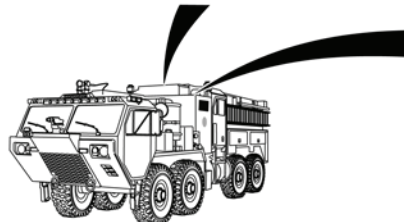

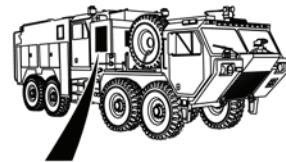

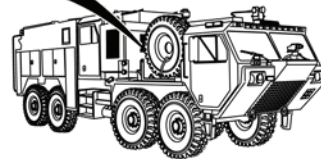
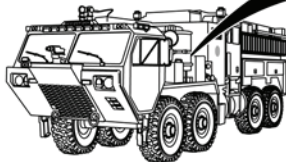
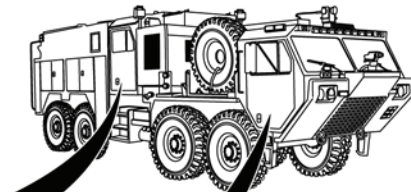
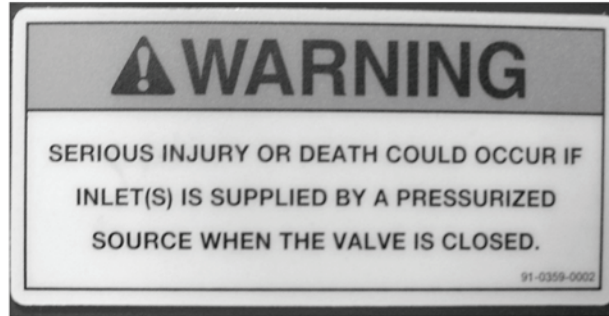
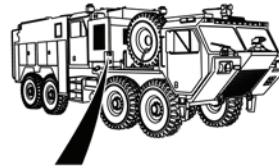

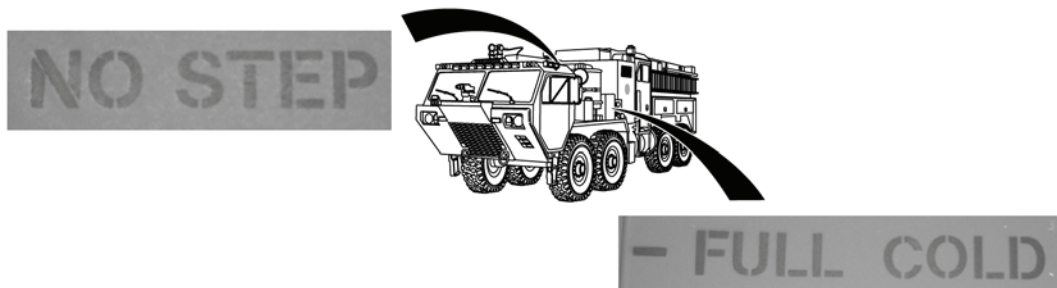
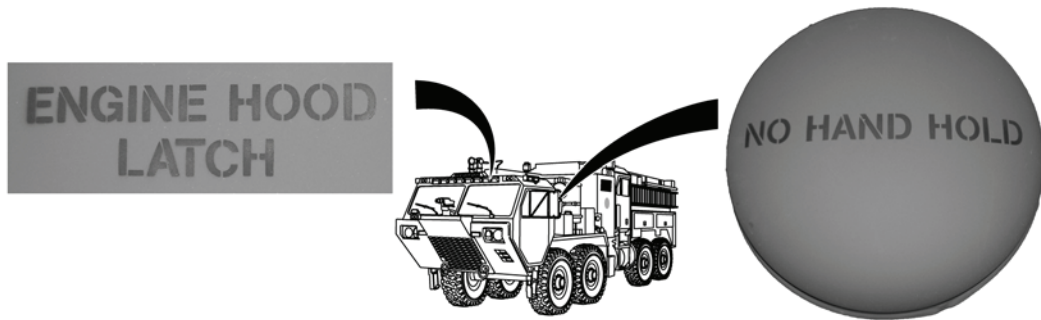
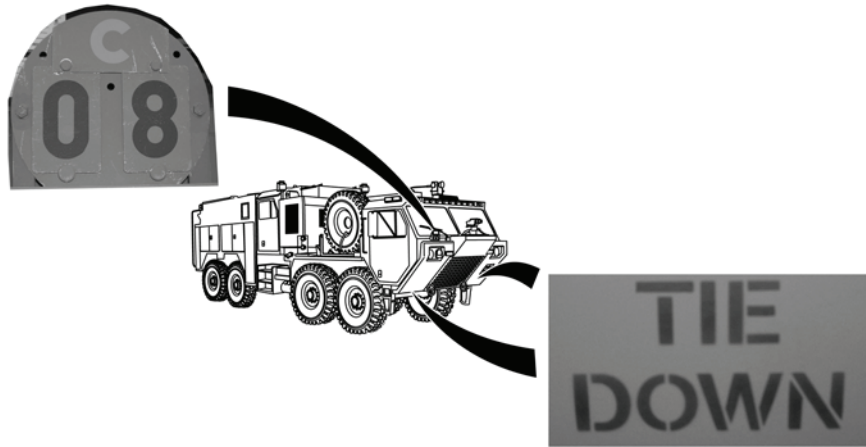

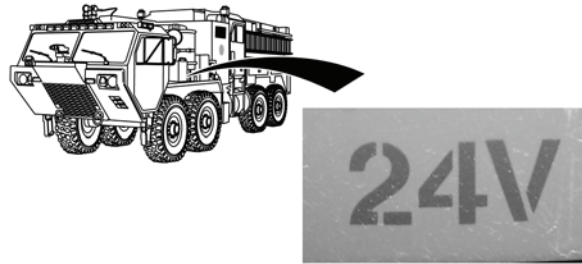
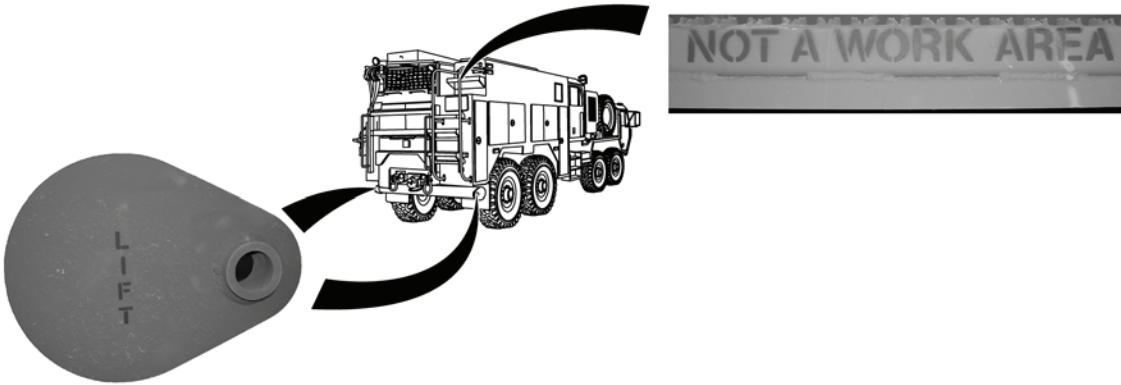

END OF WORK PACKAGE



---

**OPERATOR MAINTENANCE****ON-TRUCK LOAD PLAN**

---

**SCOPE**

This work package shows stowage locations for COEI and BII equipment necessary to support the vehicle.

**GENERAL**

Stowage locations are shown for equipment that must accompany the vehicle at all times. The BII and COEI items are covered in this work package.

Figure 1 shows the location of all stowage compartments on the vehicle.

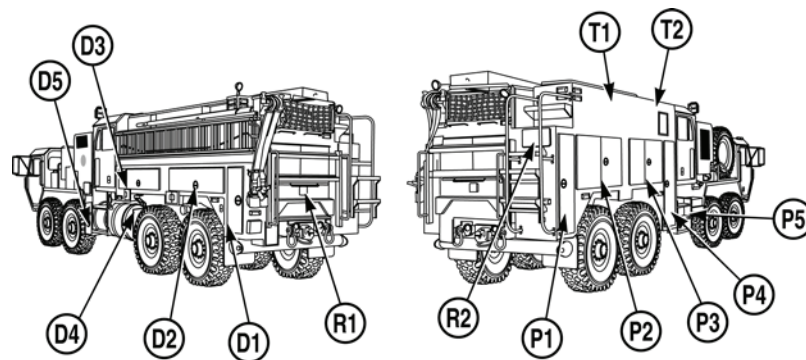

*Figure 1. Location of Stowage Compartments.*

ON-TRUCK LOAD PLAN

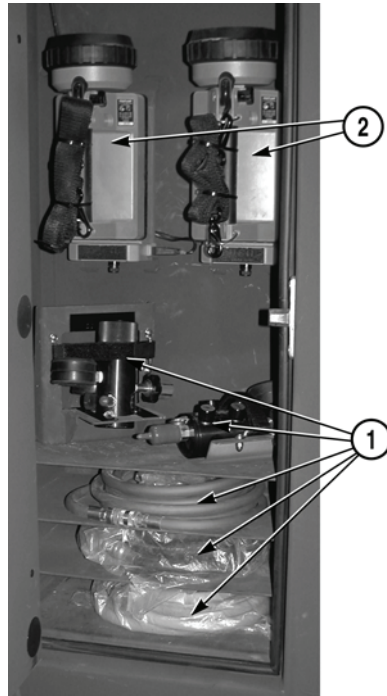

**Table 1. LOAD PLAN (STOWAGE COMPARTMENT D1).**

NO.	ITEM	QTY.
1	Air Lifting Bags Kit	1
2	Light, Hand, Streamlight Litebox	2

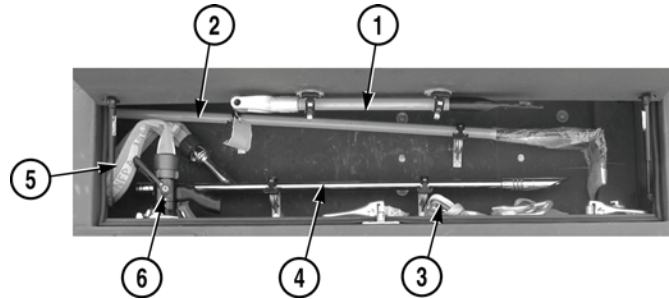

**Table 2. LOAD PLAN (STOWAGE COMPARTMENT D2).**

NO.	ITEM	QTY.
1	Pike Pole, Fiberglass, Plain Point with Hook	1
2	Hook, Trash, Arson 6 ft. long "D" Handle	1
3	Strap, Hose, and Ladder	4
4	Nozzle, Piercing, Task Force 95 GPM, 1.5 in. X 51.5 in. Long	1
5	Hose Assy., HI Combat, Yellow 1.5 in. X 36 in. Long	1
6	Valve 1.5 in. w/Grip	1

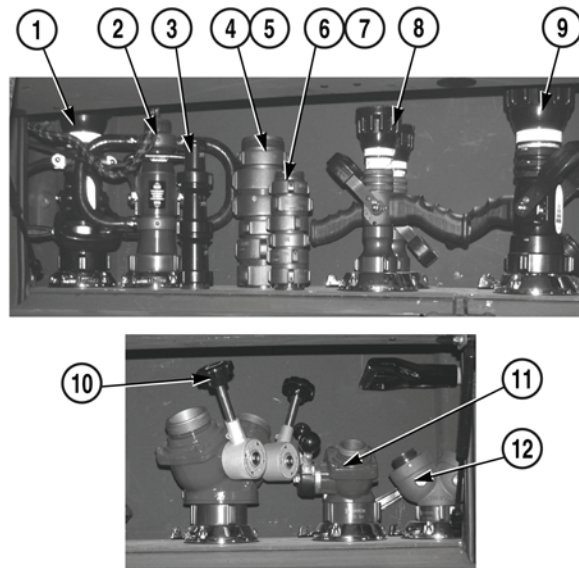

**Table 3. LOAD PLAN (STOWAGE COMPARTMENT D3).**

NO.	ITEM	QTY.
1	Nozzle, Auto Handline, Play Pipe	1
2	Play Pipe, Nozzle, Fire Hose	1
3	Tips, Triple-Stacked, TFT	1
4	Adapter, Double 2.5 in. NST, Male, Double Thread	2
5	Adapter, Double 2.5 in. NST, Female, Double Swivel	2
6	Adapter, Double 1.5 in. NST, Male, Double Thread	2
7	Adapter, Double 1.5 in. NST, Female, Double Swivel	2
8	Nozzle, Automatic, Ultimatic w/Grip (1.5 in.)	2
9	Nozzle Automatic, w/Grip (2.5 in.)	1
10	Wye, Gated, 2.5 in. x (2) 2.5 in.	1
11	Wye, Gated, 2.5 in. x (2) 1.5 in.	1
12	Wye, Gated, 1.5 in. x (2) 1.5 in.	1

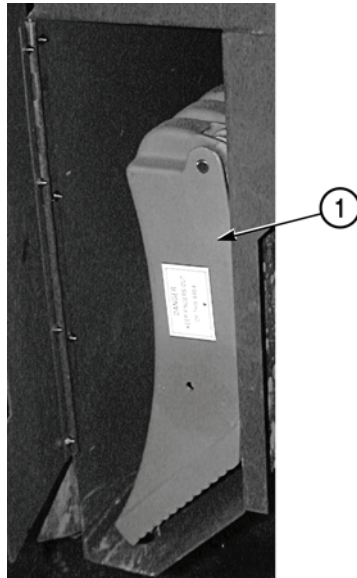

**Table 4. LOAD PLAN (STORAGE COMPARTMENT D4).**

NO.	ITEM	QTY.
1	Chocks, Wheel, Zico, Folding	2

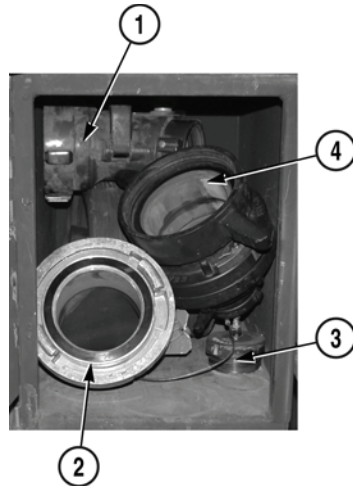

**Table 5. LOAD PLAN (STOWAGE COMPARTMENT D5).**

NO.	ITEM	QTY.
1	Siamese 2 X 2.5 in. FNST X 4 in. FNST	1
2	Suction Hose, Soft, 5 in. x 20 ft.	1
3	Plug, 2.5 in. NST, Cast, w/Air Fitting	1
4	5 in. Storz X 2.5 in. NST	2

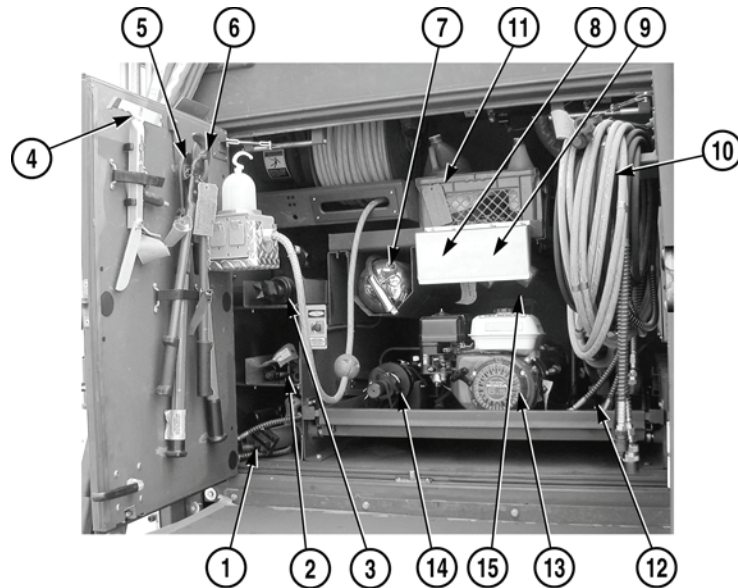

**Table 6. LOAD PLAN (STOWAGE COMPARTMENT R1).**

NO.	ITEM	QTY.
1	R-20 Ram, TNT 15.5 in. Closed Length, 7 in. Stroke	1
2	R-30 Ram, TNT 21.5 in. Closed Length, 9 in. Stroke	1
3	R-40 Ram, TNT 26.5 in. Closed Length 14 in. Stroke	1
4	Glass Cutting and Removal Tool	1
5	Cutters, Bolt 30 in. Long	1
6	Cutters, Cable, Hand-Operated; Cutting Capacity 0.38 in. Steel Wire, 21 in. Long	1
7	Extinguisher, Fire, Water 2.5 gal	1
8	Crowbar, 36 in. Long	1
9	Hammer, Sledge 12 lb. Head, Fiberglass Handle	2
10	Hose Set, Hydraulic 30 ft. Long	1
11	Chain Kit, Rescue	1
12	S-100-32 Spreader, TNT	1
13	BT-6.5 Hydraulic Power Unit, Simo, Single Reservoir	1
14	CC-20 Combination Tool, TNT	1
15	C-20 Cutter, TNT	1

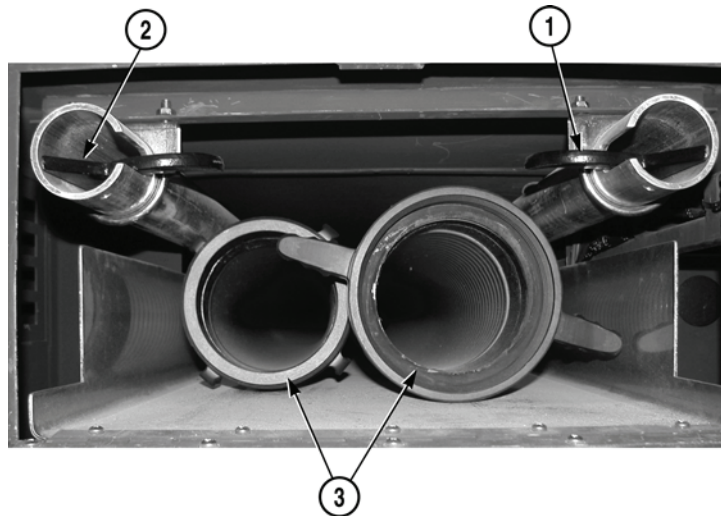

**Table 7. LOAD PLAN (STOWAGE COMPARTMENT R2).**

NO.	ITEM	QTY.
1	Pike Pole, Fiberglass 10 ft. Straight, Plain Point with Hook	1
2	Pike Pole, Fiberglass 6 ft. Straight, Plain Point with Hook	1
3	Suction Hose, Hard 5 in. X 10 ft., NST	2



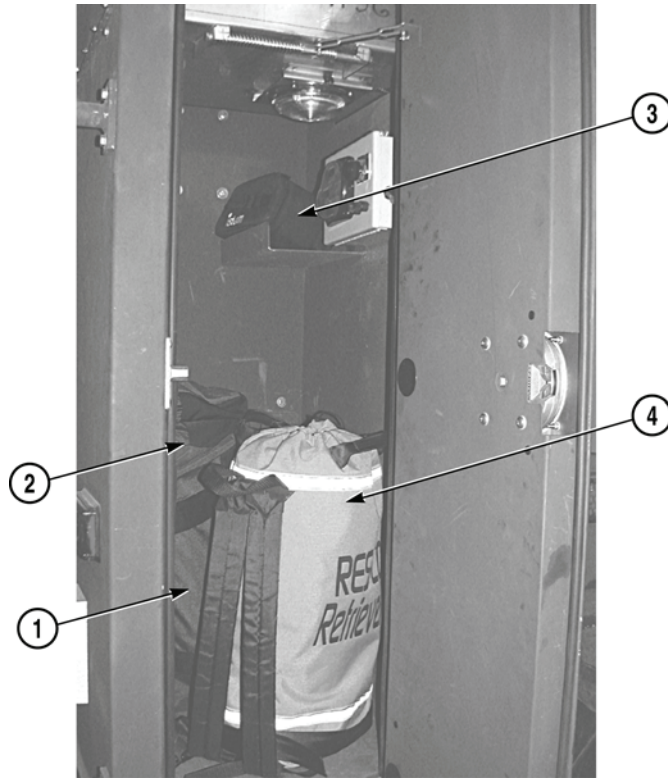

**Table 8. LOAD PLAN (STOWAGE COMPARTMENT P1).**

NO.	ITEM	QTY.
1	Trauma Kit O <sub>2</sub> Pro-To-Go Plus	1
2	Blanket, Burn, Water Gel, 6 ft. x 5 ft.	1
3	Detector, Millennium, 4 Gas	1
4	Retriever, RT	1
5	Extraction Device, KED (Not Shown)	1

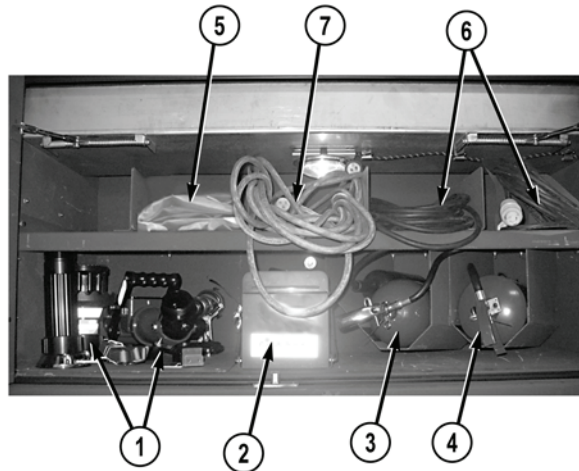

**Table 9. LOAD PLAN (STOWAGE COMPARTMENT P2).**

NO.	ITEM	QTY.
1	Monitor Package, Nozzle Tips	1
2	Chisel Kit, Air (Air Hammer)	1
3	Extinguisher, CO2 Fire, 15 lb.	1
4	Extinguisher, Fire, Dry Chemical, 20 lb.	1
5	Crash and Rescue Tool Kit	1
6	Portable Light, Cable	1
7	Extension Cord, 75 ft., 20 amp	1

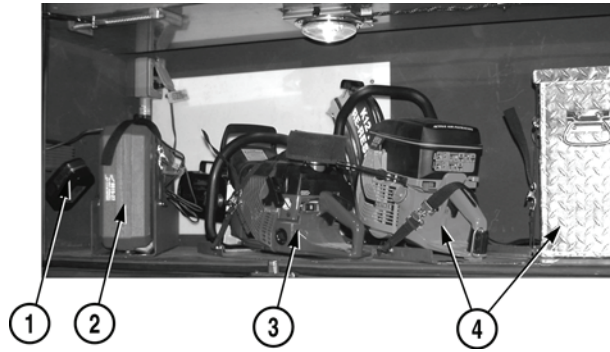

**Table 10. LOAD PLAN (STOWAGE COMPARTMENT P3).**

NO.	ITEM	QTY.
1	Reciprocating Saw, Replacement Battery	1
2	Reciprocating Saw, 18 V Cordless	1
3	Chain Saw, 20 in. Bar, w/Guard	1
4	Saw, Circular, Blade w/Toolbox	1

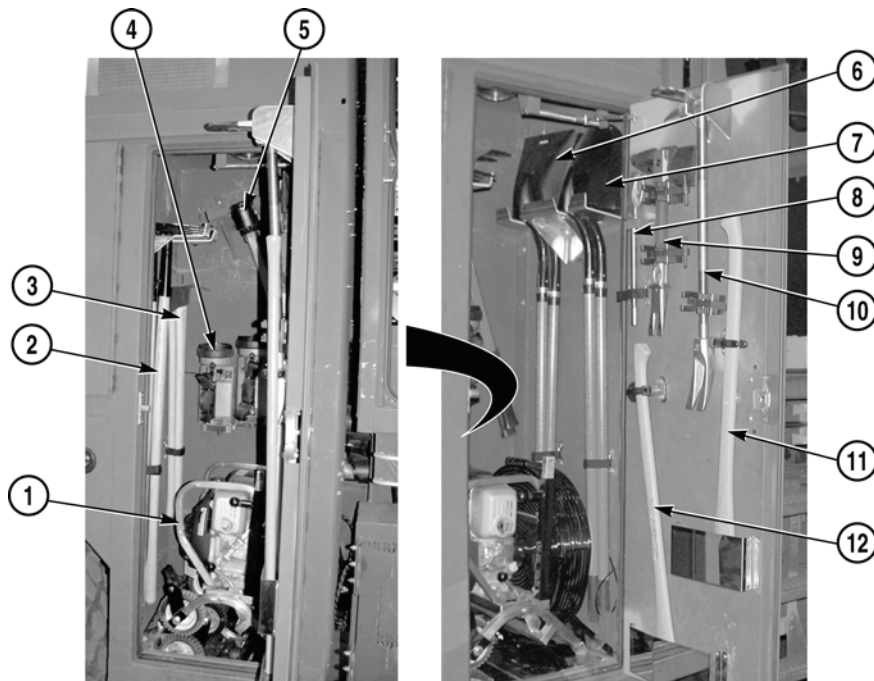

**Table 11. LOAD PLAN (STOWAGE COMPARTMENT P4).**

NO.	ITEM	QTY.
1	Fan, Positive Pressure	1
2	Forestry Fire Tool "McLeod"	1
3	Ax, Pulaski, WPL, 6 in. Handle	1
4	Light, Hand, Streamlight Litebox	2
5	Matlock, Pick, 5 lb.Fiberglass Handle	1
6	Shovel, Hand, Long Handle Square Point	2
7	Shovel, Hand, Round Point	2
8	Attachment, Pry Axe	1
9	Ax, Pry, w/Metal Cutting Claw	1
10	Hooligan Tool 10 lb. 30 in. Long X 1 in. Dia.	1
11	Ax, Single Bit 8 lb., 4.75 in. Cut, 31 in. Handle	1
12	Ax, Pick Head 8 lb., 5 in. Cut, 31 in. Handle	1

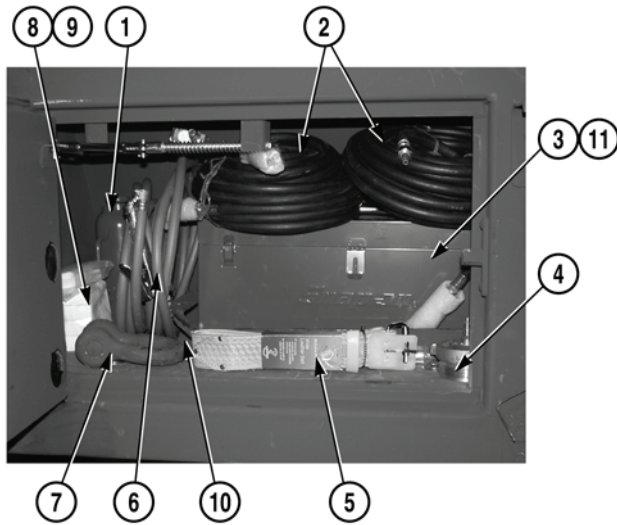

**Table 12. LOAD PLAN (STOWAGE COMPARTMENT P5).**

NO.	ITEM	QTY.
1	Jack, Hydraulic, w/Handle	1
2	Hose Assembly, Air 300 psi	2
3	Toolbox (BII)	1
4	Plug, 2.5 in. NST, Cast, w/Air Fitting	1
5	Leather Belt, Pry Axe, w/Roller Buckle	1
6	Tire Air Hose	2
7	Shackle, Towing	1
8	Padlock, without Chain	1
9	Padlock, w/Chain	4
10	Jack Plate	1
11	Air Gauges	2

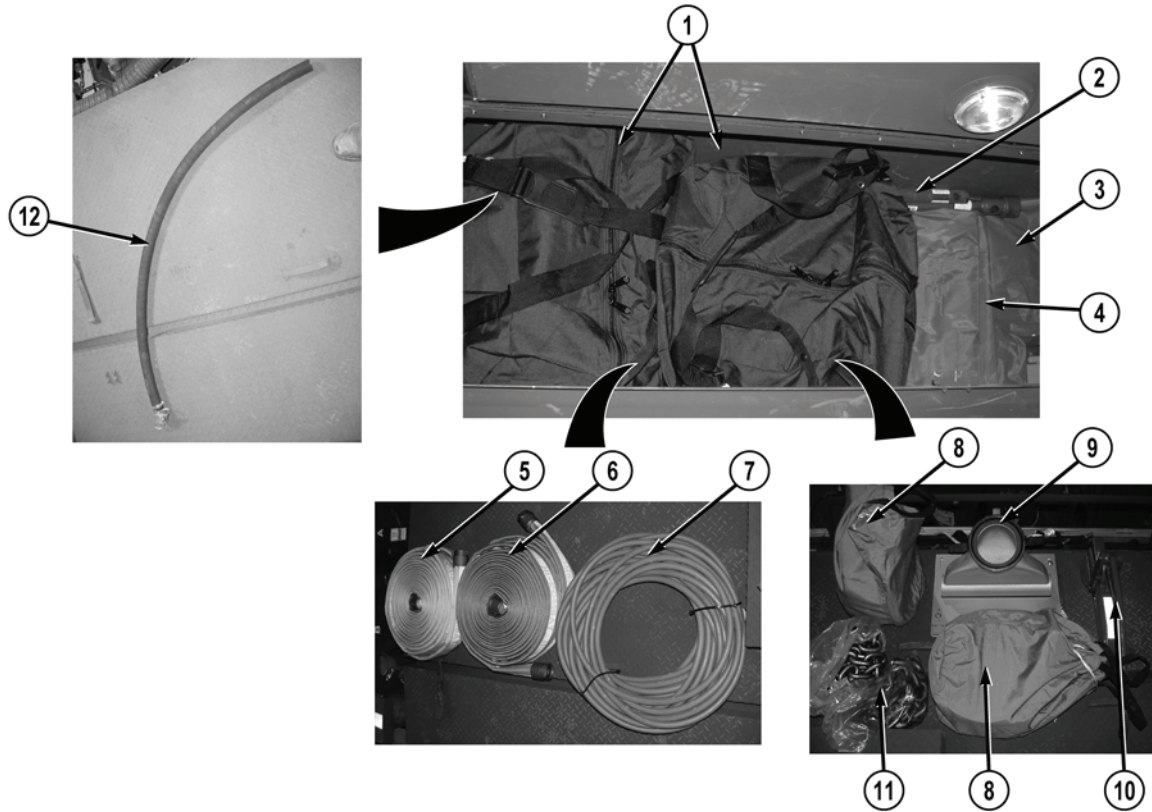

**Table 13. LOAD PLAN (STOWAGE COMPARTMENT T1).**

NO.	ITEM	QTY.
1	Cribbing, Kit, Plastic, Black	1
2	Tire Lug Removal Kit	1
3	Tarpaulin, Vinyl-Nylon, 12 ft. x 18 ft.	1
4	Tarpaulin, Vinyl-Nylon, 14 ft. x 18 ft.	1
5	Hose Assembly, HI Combat, Yellow 400 psi, 50 ft. Long	2
6	Hose Assembly, HI Combat, Green 400 psi, 50 ft. Long	2
7	Hose, Assembly, Air LO-P, 150 ft.	1
8	Rope, 0.50 in. Diameter X 300 ft. Long w/Bag	2
9	Strainer, Suction, Low Level 5 in. FNST, Aluminum, Mesh Type	1
10	Clamp, Fire Hose, Shutoff, Red, Aluminum 16.5 in. Long X 5 in. Wide X 7 in. High	1
11	Chain Kit	1
12	Hose Assembly, Foam Tank Drain	1

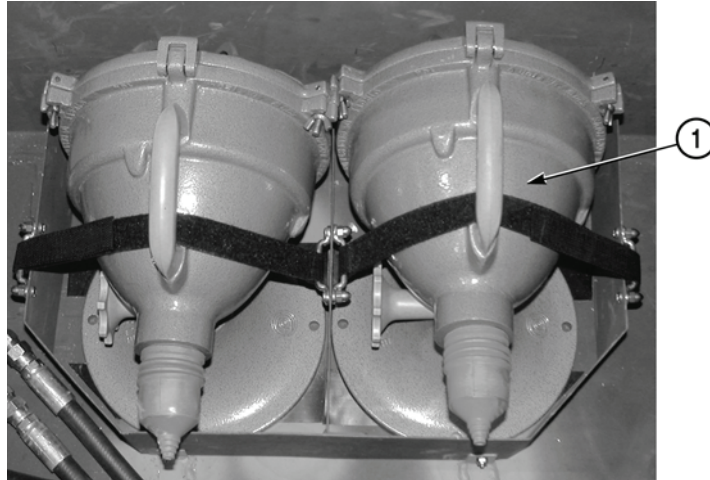

**Table 14. LOAD PLAN (STOWAGE COMPARTMENT T2).**

NO.	ITEM	QTY.
1	Light, Portable	2

**END OF WORK PACKAGE**





## **CHAPTER 3**

# **TROUBLESHOOTING PROCEDURES**



---

## OPERATOR AND FIELD LEVEL MAINTENANCE

### TROUBLESHOOTING INSTRUCTIONS INTRODUCTION

---

This chapter contains Operator and Field Level troubleshooting procedures to diagnose and correct the most common malfunctions of the TFFT. Refer to TM 9-2320-325-14&P for M977 series vehicle troubleshooting.

Each troubleshooting procedure in this manual lists a malfunction, followed by tests or inspections, and the corrective actions needed to correct the malfunction. This manual cannot list all malfunctions that may occur. Nor can it list all test, inspections, and corrective actions needed to correct the malfunctions. If a malfunction is not listed, or if listed corrective actions do not correct the malfunction, notify your Supervisor. See WP 0049 for an index of Operator Level troubleshooting procedures, and WP 0050 for Field Level troubleshooting procedures.

Before beginning any troubleshooting procedure, read and understand the operating procedures listed in Chapter 2 of this manual. Perform all applicable Preventive Maintenance Checks and Services (PMCS) procedures for the M977A2 series vehicle (TM 9-2320-325-14&P) and the M1142 series vehicle WP 0186. Ensure all system setup procedures are completed.

All steps in these troubleshooting procedures must be performed in the order listed, to ensure all system interlocks are in the correct position for system operations.

**a. Resistance Checks.**

 **CAUTION**

**Use proper sized test leads and ensure care is used when checking for resistance, continuity, or voltage at connectors or damage to equipment may result.**

1. Set the multimeter function/range switch to the desired ohm position. If the magnitude of the resistance is not known, set the switch to the highest range, then reduce range until a satisfactory reading is obtained.

**NOTE**

Some meters show "l+m", or simply "l" when function/range switch is set to an ohm position.

2. Connect red test lead to volt-ohm input connector and black lead to COM connector on multimeter. When the test leads are separated or measuring out-of-range resistance, the digital display will indicate "OL" (Over Load).
3. If the circuit being measured is connected to power, turn engine start switch OFF (TM 9-2320-347-10).
4. Connect test leads to the circuit being measured. When measuring high resistance be careful not to contact adjacent point, even if they are insulated. Some insulators have a relatively low insulation resistance which can effect the resulting measurement.
5. Read the resistance value on the digital display.
6. If your meter does not work in this manner, learn how it operates before performing troubleshooting.

**b. Continuity Checks.**

1. Set the multimeter function/range switch to any ohm range.

**NOTE**

Some meters show "l+m", or simply "l" when function/range switch is set to an ohm position.

2. Connect red test lead to volt-ohm input connector and black lead to COM connector on multimeter. When the test leads are separated or measuring out-of-range resistance, the digital display will indicate "OL" (Over Load).
3. If the circuit being measured is connected to power, turn engine start switch OFF (TM 9-2320-347-10).
4. Connect test lead to one end of the wire or circuit to be measured. Use the other test lead to trace the circuit being measured. When continuity is established, an ohm symbol will appear in the upper left corner of the digital display. If contact with the circuit is maintained long enough (about 1/4 second), the "OL" display will disappear and the resistance value if the circuit will be displayed. A resistance value of 200 ohms or less indicates continuity is being measured.
5. If your multimeter does not work in this manner, learn how it operates before performing troubleshooting.

**c. Voltage Checks.**

The TFFT is equipped with 24 VDC circuits. However, a valid reading may vary from 22 to 28 VDC, depending on the charge on the batteries. When the batteries are fully charged, 25.2 VDC can be measured on an open 24 VDC circuit, and 29 VDC can be measured when the engine is running at 1000 rpm.

1. Set the multimeter function/range switch to the desired volts position. If the magnitude of the voltage is not known, set the switch to the highest range, then reduce range until a satisfactory reading is obtained. If a DC-AC switch is present, make sure it is set to the DC position
2. Connect red test lead to volt-ohm input connector and black lead to COM connector on multimeter.
3. Connect the tests leads to the circuit being measured. Connecting the red lead to the positive (+) connection and the black test lead to the negative (-) or ground connection.
4. Turn on switches as indicated in test procedure, to apply power to circuit being measured.
5. Read the voltage value on the digital display.
6. If your meter does not work in this manner, learn how it operates before performing troubleshooting.

**d. General Wire Testing and Repair.**

Troubleshooting for the TFFT electrical system isolates malfunctions down to specific faulty components, using resistance, continuity, and voltage checks as noted above. When the troubleshooting isolates the malfunction to a faulty wire, the wire harness may be repaired or some cases replaced at Field Level Maintenance. If the wire harness cannot be repaired or replaced at Field Level Maintenance, notify your Supervisor.

Wire repair at Field Level Maintenance is limited to splicing and taping the faulty wire. Refer to TM 9-2320-325-14&P for wire harness repair procedures.

**END OF WORK PACKAGE**

**OPERATOR MAINTENANCE**

**OPERATOR LEVEL TROUBLESHOOTING FAULT INDEX**

*Table 1. Operator Level Troubleshooting Fault Index.*

<b>Troubleshooting Procedure</b>	<b>Work Package</b>
120 VAC Outlet(s) Does Not Operate . . . . .	WP 0051
24-Volt Battery Charger Does Not Operate . . . . .	WP 0052
Check Pump Engine Light Comes On . . . . .	WP 0053
Crew Cab Air Conditioning Does Not Operate Properly . . . . .	WP 0054
Crew Cab Heater Does Not Operate Properly . . . . .	WP 0055
Deck Lights, Crew Cab Dome Lights, Clearance Lights, and Compartment Lights Do Not Operate. . . . .	WP 0056
DO NOT MOVE APPARATUS WHEN LIGHT IS ON Indicator Flashes . . . . .	WP 0057
Extendable Floodlights Do Not Operate . . . . .	WP 0058
Streamlight Battery Charger(s) Does Not Charge Batteries . . . . .	WP 0059
Foam System Does Not Operate . . . . .	WP 0060
Pump Engine Cranks But Fails to Start . . . . .	WP 0061
Pump Engine Governor Control Does Not Operate . . . . .	WP 0062
Pump Engine Runs Rough or Shuts Down While Running . . . . .	WP 0063
Pump Does Not Prime . . . . .	WP 0064
Pump Loses Prime . . . . .	WP 0065
Drain Valves Leaking During Pumping Operations. . . . .	WP 0066
Handheld Radio Battery Charger(s) Does Not Charge Batteries . . . . .	WP 0067
Warning Lights Do Not Operate . . . . .	WP 0068
Discharges Have Abnormal Water Streams . . . . .	WP 0069

**END OF WORK PACKAGE**



**FIELD LEVEL MAINTENANCE**

**FIELD LEVEL MAINTENANCE TROUBLESHOOTING FAULT INDEX**

*Table 1. Field Level Maintenance Troubleshooting Fault Index.*

<b>Troubleshooting Procedure</b>	<b>Work Package</b>
<b>REFRIGERATION AND AIR CONDITIONING COMPONENTS</b>	
Crew Cab Air Conditioner/Heater Does Not Operate Properly . . . . .	0070
Crew Cab Air Conditioner Compressor Excessively Noisy . . . . .	0071
Crew Cab Air Conditioner Does Not Cool or Cools Inadequately . . . . .	0072
<b>FIRE PUMP SYSTEM</b>	
Water Pump Engine Cranks But Will Not Start or Hard to Start From Personnel Cab and Pump Operator's Panel. . . . .	0073
Water Pump Engine Fails To Crank From Personnel Cab and Pump Operator's Panel . . . . .	0074
Water Pump Engine Fails To Crank From Personnel Cab . . . . .	0075
Water Pump Engine Fails To Crank From Pump Operator's Panel . . . . .	0076
Water Pump Engine Pressure Governor Control Panel Does Not Change Engine Speed . . . . .	0077
Water Pump Engine Pressure Governor Control Panel Does Not Change Pump Pressure . . . . .	0078
Water Pump Engine Pressure Governor Control Panel Message Center Displays Sensor or Cavitate . . . . .	0079
Water Pump Engine Pressure Governor Control Panel Changes Engine Speed, But Oscillates While In RPM Mode. . . . .	0080
Water Pump Engine Pressure Governor Control Panel Changes Engine Speed, But Oscillates While In PSI Mode. . . . .	0081
Water Pump Engine Pressure Governor Controls Do Not Maintain System Pressure When Discharge Valve is Being Opened or Closed . . . . .	0082
Water Pump Engine Pressure Governor Control Panel PSI PRESET Control Does Not Operate. . . . .	0083
Water Pump Engine Hourmeter Does Not Operate . . . . .	0084
Water Pump Engine is Hard To Start When Cold (Below 32°F [0°C]). . . . .	0085
Water Pump Engine is Producing Blue Exhaust Smoke (Water Temp Reads Over 180°F [82°C]) . . . . .	0086
Water Pump Engine is Producing Excessive Black or Gray Exhaust Smoke (Water Temp Reads Over 180°F [82°C]) . . . . .	0087
Water Pump Engine is Producing White Exhaust Smoke (Water Temp Reads Over 180°F [82°C]) . . . . .	0088

**Table 1. Field Level Maintenance Troubleshooting Fault Index. (Continued)**

Troubleshooting Procedure	Work Package
Water Pump Engine Misfires, Runs Rough, or Lacks Power . . . . .	0089
Water Pump Noisy . . . . .	0090
Water Pump Engine Oil Consumption is High or Leaks Oil. . . . .	0091
Water Pump Engine Oil Pressure is Low or Water Pump Engine Starts and Stops . . . . .	0092
Water Pump Engine Overheats . . . . .	0093
<b>FOAM PROPORTIONER SYSTEM</b>	
Foam Not Delivered From All Systems (Bumper Turret, Ground Sweeps, and Manual Metering Controls) or System Does Not Shut Off . . . . .	0094
Foam Not Delivered When Tank A is Selected (Bumper Turret, Ground Sweeps, and Manual Metering Controls) . . . . .	0095
Foam Not Delivered When Tank B is Selected (Bumper Turret, Under Truck Nozzles, and Manual Metering Controls) . . . . .	0096
Foam Not Delivered From Bumper Turret . . . . .	0097
Foam Not Delivered From Roof Turret . . . . .	0098
Foam Not Delivered From Ground Sweeps . . . . .	0099
Foam Not Delivered When Manual Metering Control is Operated . . . . .	0100
Foam System Cannot Be Flushed. . . . .	0101
Foam A Tank Level Indicator Gauge Does Not Operate Properly . . . . .	0102
Foam B Tank Level Indicator Gauge Does Not Operate Properly . . . . .	0103
<b>WATER TANK ASSEMBLY</b>	
Bumper Turret Does Not Operate Properly When Selected . . . . .	0104
Direct Tank Fill Valve Does Not Operate Properly (Auto or Manual Mode) . . . . .	0105
Driver Main Inlet Valve Does Not Operate Properly . . . . .	0106
Driver Side Pre-Connect A Valve Does Not Operate Properly . . . . .	0107
Driver Side Pre-Connect B Valve Does Not Operate Properly . . . . .	0108
No. 1 Discharge Valve (Driver Side) Does Not Operate Properly . . . . .	0109
No. 2 Discharge Valve (Driver Side) Does Not Operate Properly . . . . .	0110
No. 3 Discharge Valve (Passenger Side) Does Not Operate Properly . . . . .	0111
No. 4 Discharge Valve (Passenger Side) Does Not Operate Properly . . . . .	0112
Passenger Side Auxiliary Inlet Valve Does Not Operate Properly. . . . .	0113
Pump Cooler Valve Does Not Operate Properly . . . . .	0114
Pump Priming System Does Not Operate Properly. . . . .	0115



**Table 1. Field Level Maintenance Troubleshooting Fault Index. (Continued)**

<b>Troubleshooting Procedure</b>	<b>Work Package</b>
Roof Turret Does Not Operate When Selected . . . . .	0116
Tank Fill & Re-Circulating Valve Does Not Operate Properly . . . . .	0117
Tank-to-Pump Valve(s) Does Not Operate Properly . . . . .	0118
Ground Sweeps Do Not Operate When Selected . . . . .	0119
Hydraulic Generator PTO Does Not Engage When Selected . . . . .	0120
Water Tank Drain Valve Does Not Operate When Selected . . . . .	0121
Water Tank Level Indicator Gauge Does Not Operate Properly . . . . .	0122
Water Pump Output Pressure is Low . . . . .	0123
Windshield Deluge System Does Not Operate Properly . . . . .	0124
<b>INSTRUMENT HOUSING ASSEMBLY</b>	
Cab Switch Backlighting Does Not Operate . . . . .	0125
Digital Pressure Gauge(s) Does Not Operate . . . . .	0126
Direct Tank Fill AUTO Indicator Does Not Illuminate (Pump Operator's Panel) . . . . .	0127
Direct Tank Fill OPEN Indicator Does Not Illuminate (Pump Operator's Panel) . . . . .	0128
DO NOT MOVE APPARATUS WHEN LIGHT IS ON Indicator Does Not Operate Properly . . . . .	0129
Equipment (Ladder) Rack Does Not Operate . . . . .	0130
FOAM FLUSH Indicator Does Not Illuminate (Pump Operator's Panel) . . . . .	0131
FOAM SYSTEM Indicator Does Not Illuminate (Cab) . . . . .	0132
FOAM SYSTEM Indicator Does Not Illuminate (Pump Operator's Panel) . . . . .	0133
Pump Cooler Open Indicator Does Not Illuminate (Cab) . . . . .	0134
PUMP COOLER Indicator Does Not Illuminate (Pump Operator's Panel) . . . . .	0135
PUMP ENGINE RUNNING Indicator Not Illuminated When Water Pump Engine is Running . . . . .	0136
PUMP HOT Alarm/Indicator Does Not Operate When Tested or Pump Overheat Condition (Pump Operator's Panel) . . . . .	0137
GEN PTO ENGAGE Indicator Does Not Illuminate (Cab) . . . . .	0138
Roof Turret Indicator Does Not Operate . . . . .	0139
TANK DRAIN Indicator Does Not Illuminate (Pump Operator's Panel) . . . . .	0140
TANK TO PUMP Indicator Does Not Illuminate (Cab) . . . . .	0141
TANK TO PUMP Indicator Does Not Illuminate (Pump Operator's Panel) . . . . .	0142
GROUND SWEEPS Indicator Does Not Illuminate (Cab) . . . . .	0143

**Table 1. Field Level Maintenance Troubleshooting Fault Index. (Continued)**

Troubleshooting Procedure	Work Package
Water Pump Engine Pressure Governor Control Panel is Not Disabled, When Other Governor Control Panel is Activated . . . . .	0144
Water Pump Engine Pressure Governor Control Panel Does Not Operate Properly . . . . .	0145
Water Pump Engine Pressure Governor Control Panel Throttle Ready and/or Pump Engage LEDs Do Not Illuminate . . . . .	0146
Water Pump Engine Pressure Governor Control Panel Message Display is Garbled or Dim . . . . .	0147
Water Pump Engine Gauge Panel Does Not Operate Properly . . . . .	0148
<b>SIREN ASSEMBLY</b>	
Siren Does Not Operate Properly . . . . .	0149
<b>WARNING LIGHT ASSEMBLY</b>	
Warning Lights (All) Do Not Operate . . . . .	0150
Warning Lights (Front and Rear) Do Not Operate . . . . .	0151
Warning Lights (Overhead Beacon) Do Not Operate . . . . .	0152
Warning Lights (Cab Roof Lightbar) Do Not Operate . . . . .	0153
Warning Lights (Side) Do Not Operate . . . . .	0154
Warning Lights (Upper Rear) Do Not Operate . . . . .	0155
<b>SPOTLIGHTS</b>	
Deck Lights Do Not Operate . . . . .	0156
Extendable Floodlights Do Not Operate . . . . .	0157
<b>DOME AND ENGINE LIGHT ASSEMBLY</b>	
Crew Cab Dome Light Does Not Operate . . . . .	0158
<b>MISCELLANEOUS ELECTRICAL COMPONENTS</b>	
12-Volt Handheld Radio Battery Charger(s) Does Not Operate (Personnel Cab) . . . . .	0159
12-Volt Handheld Radio Battery Charger(s) Does Not Operate (Crew Cab) . . . . .	0160
12-Volt Flashlight Charger(s) Does Not Operate . . . . .	0161
120-Volt Air Compressor Does Not Operate Properly . . . . .	0162
120-Volt Receptacles Do Not Operate . . . . .	0163
120-Volt Cord Reel Receptacles Do Not Operate . . . . .	0164
24-Volt Battery Charger Does Not Operate . . . . .	0165
Battery Equalizer Does Not Operate Properly . . . . .	0166
Clearance and/or Directional Light(s) Does Not Operate . . . . .	0167
Cord Reel Rewind Control Does Not Operate . . . . .	0168
Two-Way Radio Does Not Operate Properly . . . . .	0169

**Table 1. Field Level Maintenance Troubleshooting Fault Index. (Continued)**

Troubleshooting Procedure	Work Package
Hydraulic Generator Does Not Operate Properly . . . . .	0170
Hydraulic Generator Oil Cooling Fan Does Not Operate Properly . . . . .	0171
Intercom and Headsets Do Not Operate Properly . . . . .	0172
Passenger Side and Rear Stowage Compartment Light(s) Do Not Operate . . . . .	0173
Pump House Fan Does Not Operate Properly . . . . .	0174
Pump House or Pump Operator's Panel Work Light(s) Does Not Operate . . . . .	0175
Driver Side Stowage Compartment Light(s) Does Not Operate . . . . .	0176
Rear Step Buzzer Does Not Operate Properly . . . . .	0177
SINCGARS Do Not Operate Properly . . . . .	0178
Shoreline Inlet Receptacle Does Not Operate Properly . . . . .	0179
<b>HEATER, VEHICULAR COMPARTMENT</b>	
Piping Heat Trace Does Not Operate Properly. . . . .	0180
Pump House Heater Does Not Operate Properly. . . . .	0181
Rear Compartment Heater Does Not Operate Properly . . . . .	0182
Water Tank Heater Does Not Operate Properly . . . . .	0183

**END OF WORK PACKAGE**



**OPERATOR LEVEL MAINTENANCE**

**120 VAC OUTLET(S) DOES NOT OPERATE**

**INITIAL SETUP:**

**References**

WP 0007  
WP 0021

**Equipment Conditions**

Water pump engine OFF (WP 0022)  
Engine OFF (TM 9-2320-347-10)  
Wheels chocked (TM 9-2320-347-10)

**MALFUNCTION**

**TEST OR INSPECTION**

**CORRECTIVE ACTION**

**120 VAC OUTLET(S) DOES NOT OPERATE**

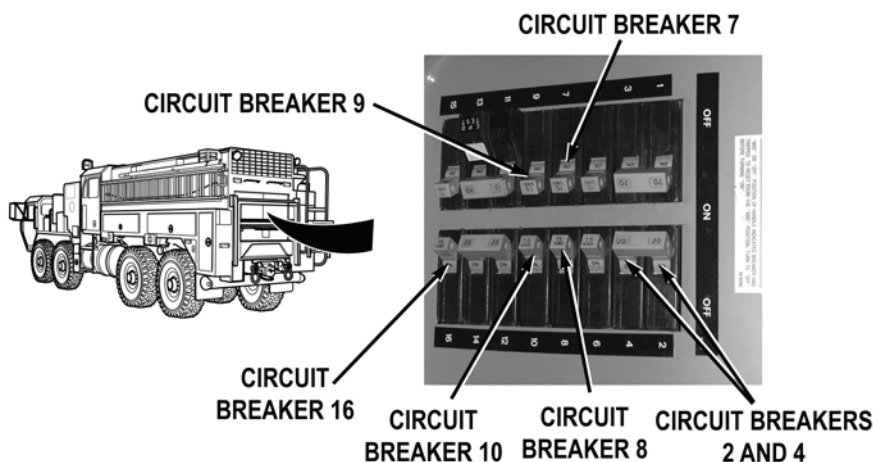

Step 1. Turn battery disconnect switch to ON position (WP 0007). Start engine (TM 9-2320-347-10). Start hydraulic generator (WP 0021). Check if any other 120 VAC outlets do not operate.

If all 120 VAC outlets do not operate, notify Supervisor.

**NOTE**

Circuit breaker may be in ON position when tripped. To make sure circuit breaker is not tripped, reset circuit breaker by switching it to OFF position and then back to ON position.

Step 2. If cord reel outlets do not operate, check if circuit breaker 2 or 4 is tripped.

If circuit breaker 2 or 4 is tripped, reset tripped circuit breaker. If circuit breaker trips again, notify Supervisor.

Step 3. If driver side pump house outlets do not operate, check if circuit breaker 7 is tripped.

If circuit breaker 7 is tripped, reset tripped circuit breaker. If circuit breaker trips again, notify Supervisor.

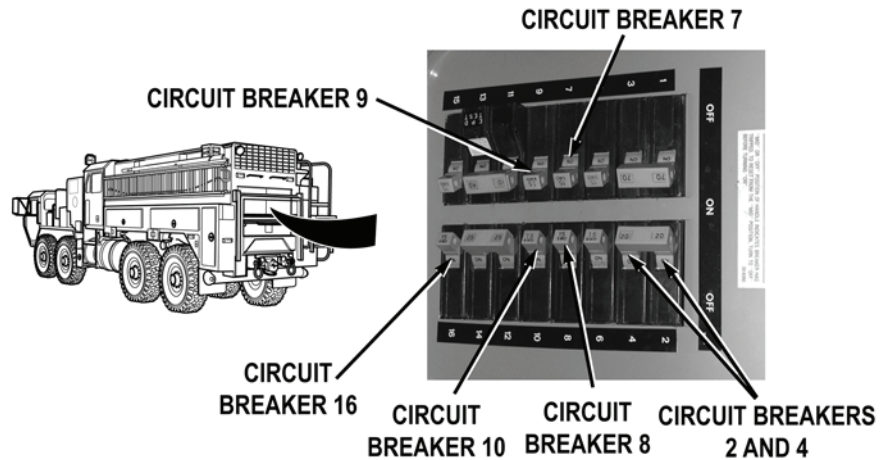
**MALFUNCTION****TEST OR INSPECTION****CORRECTIVE ACTION**

- Step 4. If passenger side pump house outlets do not operate, check if circuit breaker 8 is tripped.
- If circuit breaker 8 is tripped, reset tripped circuit breaker. If circuit breaker trips again, notify Supervisor.
- Step 5. If driver side rear outlets do not operate, check if circuit breaker 9 is tripped.
- If circuit breaker 9 is tripped, reset tripped circuit breaker. If circuit breaker trips again, notify Supervisor.
- Step 6. If passenger side rear outlets do not operate, check if circuit breaker 10 is tripped.
- If circuit breaker 10 is tripped, reset tripped circuit breaker. If circuit breaker trips again, notify Supervisor.
- Step 7. If reciprocating saw charger outlets do not operate, check to see if circuit breaker 16 is tripped.
- a. If circuit breaker 16 is tripped, reset tripped circuit breaker. If circuit breaker trips again, notify Supervisor.
  - b. If problem still exists, notify Supervisor.

**END OF TASK****FOLLOW-ON MAINTENANCE**

Remove wheel chocks (TM 9-2320-347-10)

**END OF TASK****END OF WORK PACKAGE**

**OPERATOR LEVEL MAINTENANCE**

**24-VOLT BATTERY CHARGER DOES NOT OPERATE**

**INITIAL SETUP:**

**References**  
WP 0010

**Equipment Conditions**  
Water pump engine OFF (WP 0022)  
Engine OFF (TM 9-2320-347-10)  
Wheels chocked (TM 9-2320-347-10)

**MALFUNCTION**

**TEST OR INSPECTION**

**CORRECTIVE ACTION**

**24-VOLT BATTERY CHARGER DOES NOT OPERATE**



**SHORELINE INLET  
RECEPTACLE WITH  
POWER CORD  
CONNECTED**

**WARNING**



**110-volt AC power is potentially lethal. Do not work on AC wiring when it is connected to a power source. Failure to comply may cause injury or death to personnel.**

- Step 1. Check if power cord is connected to SHORELINE INLET receptacle and power source receptacle.

If power cord is not connected, connect power cord.

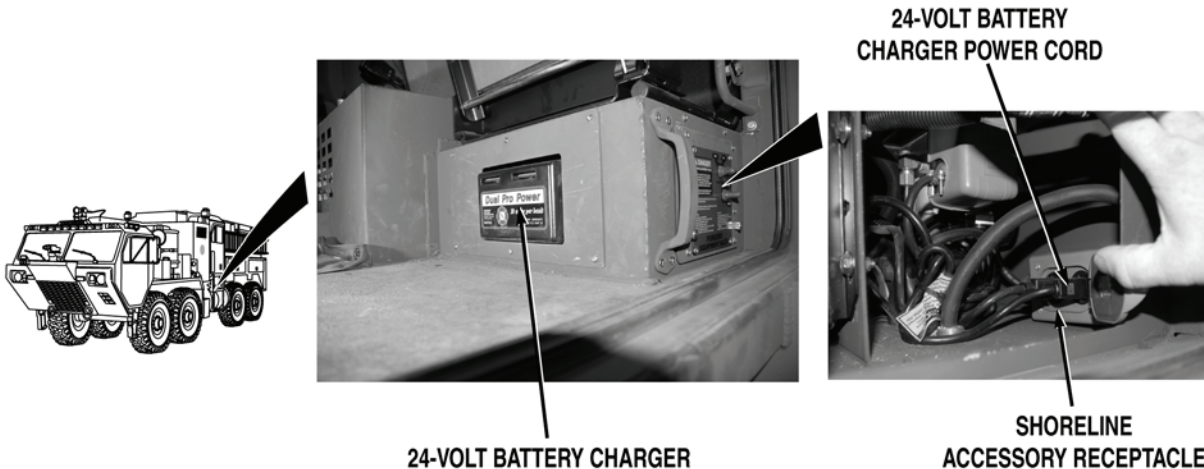
**MALFUNCTION****TEST OR INSPECTION****CORRECTIVE ACTION**

Step 2. Open ladder rack control panel (WP 0010). Check if battery charger power cord is plugged into shoreline accessory receptacle.

- a. If battery charger power cord is not plugged into shoreline accessory receptacle, plug power cord into receptacle.
- b. If battery charger power cord is plugged into shoreline accessory receptacle, notify Supervisor.

**END OF TASK****FOLLOW-ON MAINTENANCE**

1. Close ladder rack control panel (WP 0010)
2. Remove wheel chocks (TM 9-2320-347-10)

**END OF TASK****END OF WORK PACKAGE**



---

**OPERATOR LEVEL MAINTENANCE**  
**CHECK PUMP ENGINE LIGHT COMES ON**

---

**INITIAL SETUP:**

**References**  
WP 0186

**Equipment Conditions**

Water pump engine OFF (WP 0022)  
Engine OFF (TM 9-2320-347-10)  
Wheels chocked (TM 9-2320-347-10)

---

**MALFUNCTION****TEST OR INSPECTION****CORRECTIVE ACTION**

---

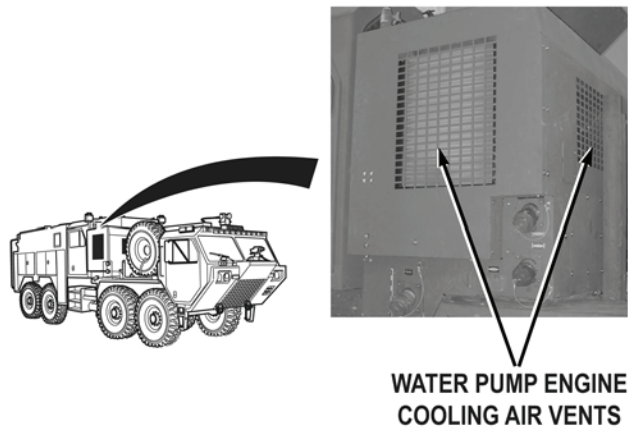
**CHECK PUMP ENGINE LIGHT COMES ON**

Step 1. Check water pump engine cooling air vents for blockage.

If pump engine cooling air vents are blocked, clear blockage.

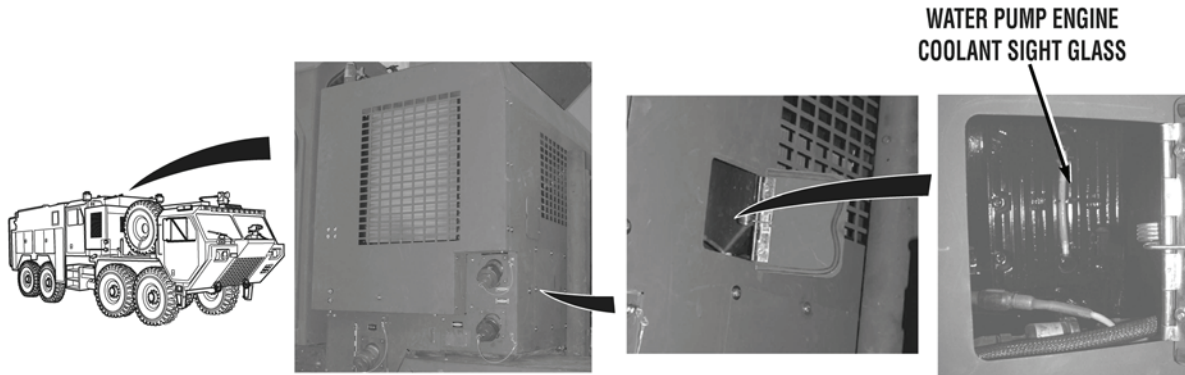
**MALFUNCTION****TEST OR INSPECTION****CORRECTIVE ACTION****WARNING**

**Cooling system components become hot during operation. Make sure cooling system components are cool prior to checking.**

Step 2. Check water pump engine coolant sight glass for proper level.

If pump engine coolant is low, fill to correct level (WP 0186).

Step 3. Check water pump engine oil for proper level.

a. If pump engine oil is low, fill to correct level (WP 0186).

b. If problem still exists, notify Supervisor.

**END OF TASK****FOLLOW-ON MAINTENANCE**

Remove wheel chocks (TM 9-2320-347-10)

**END OF TASK****END OF WORK PACKAGE**

**OPERATOR LEVEL MAINTENANCE**

**CREW CAB AIR CONDITIONING DOES NOT OPERATE PROPERLY**

**INITIAL SETUP:**

**References**

- WP 0007
- WP 0021
- WP 0051

**Equipment Conditions**

- Water pump engine OFF (WP 0022)
- Engine OFF (TM 9-2320-347-10)
- Wheels chocked (TM 9-2320-347-10)

**MALFUNCTION**

**TEST OR INSPECTION**

**CORRECTIVE ACTION**

**CREW CAB AIR CONDITIONING DOES NOT OPERATE PROPERLY**

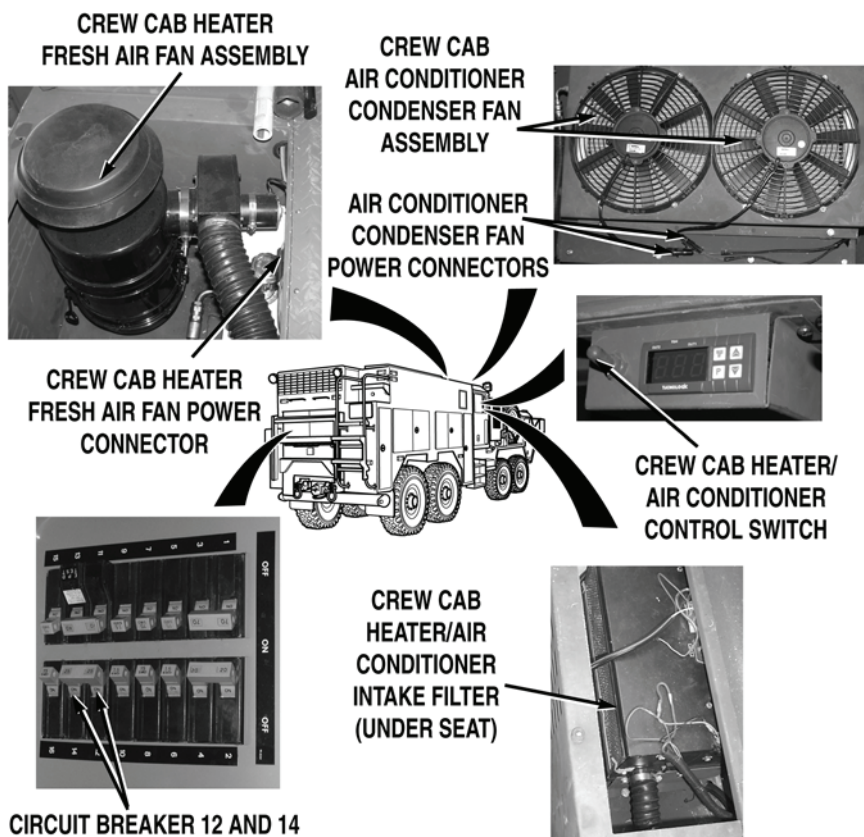

Step 1. Turn battery disconnect switch to ON position (WP 0007). Start engine (TM 9-2320-347-10). Start hydraulic generator (WP 0021). Check if any other 120 VAC outlets operate.

If all 120 VAC outlets do not operate, troubleshoot 120 VAC Outlet(s) Does Not Operate (WP 0051).

---

**MALFUNCTION****TEST OR INSPECTION****CORRECTIVE ACTION**

---

**NOTE**

Circuit breaker may be in ON position when tripped. To make sure circuit breaker is not tripped, reset circuit breaker by switching it to OFF position then back to ON position.

- Step 2. Check if circuit breakers 12 or 14 are tripped.
- a. If circuit breakers 12 or 14 are tripped, reset tripped circuit breaker.
  - b. If circuit breakers trip again, notify Supervisor.
- Step 3. Check if crew cab heater/air conditioner control switch is in ON position.
- If crew cab heater/air conditioner control switch is not in ON position, place switch in ON position.
- Step 4. Check if crew cab heater/air conditioner intake filter is free from blockage.
- If crew cab heater/air conditioner intake filter is blocked, clear blockage.
- Step 5. Check if crew cab air conditioner condenser fan assembly is free from blockage.
- If crew cab air conditioner condenser fan assembly is blocked, clear blockage.
- Step 6. Check if crew cab air conditioner condenser fan power connectors are connected.
- If crew cab air conditioner condenser fan power connectors are not connected, connect them.
- Step 7. Check if crew cab heater fresh air fan assembly is free from blockage.
- If crew cab heater fresh air fan assembly is blocked, clear blockage.
- Step 8. Check if crew cab heater fresh air fan power connector is connected.
- a. If crew cab heater fresh air fan power connector is not connected, connect it.
  - b. If problem still exists, notify Supervisor.

**END OF TASK****FOLLOW-ON MAINTENANCE**

Remove wheel chocks (TM 9-2320-347-10)

**END OF TASK****END OF WORK PACKAGE**

**OPERATOR LEVEL MAINTENANCE**

**CREW CAB HEATER DOES NOT OPERATE PROPERLY**

**INITIAL SETUP:**

**References**

WP 0004  
WP 0007

**Equipment Conditions**

Water pump engine OFF (WP 0022)  
Engine OFF (TM 9-2320-347-10)  
Wheels chocked (TM 9-2320-347-10)

**MALFUNCTION**

**TEST OR INSPECTION**

**CORRECTIVE ACTION**

**CREW CAB HEATER DOES NOT OPERATE PROPERLY**



**CREW CAB HEATER/AIR  
CONDITIONER CONTROL SWITCH**

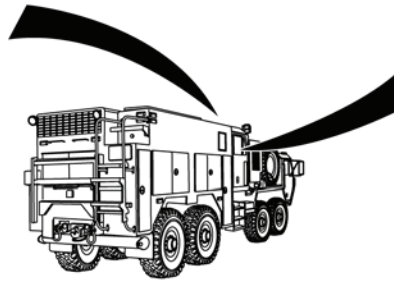

**CREW CAB HEATER/AIR  
CONDITIONER INTAKE  
FILTER (UNDER SEAT)**

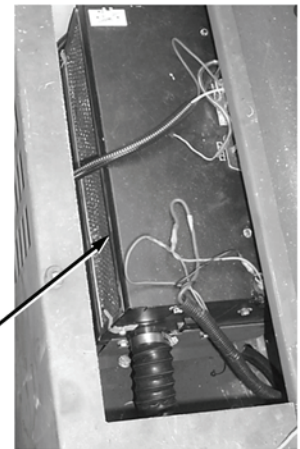

- Step 1. Check if crew cab heater/air conditioner control switch is in ON position.  
If crew cab heater/air conditioner control switch is not in ON position, place switch in ON position.
- Step 2. Check if crew cab heater/air conditioner intake filter is free from blockage.  
If crew cab heater/air conditioner intake filter is blocked, clear blockage.

---

**MALFUNCTION****TEST OR INSPECTION****CORRECTIVE ACTION**

---

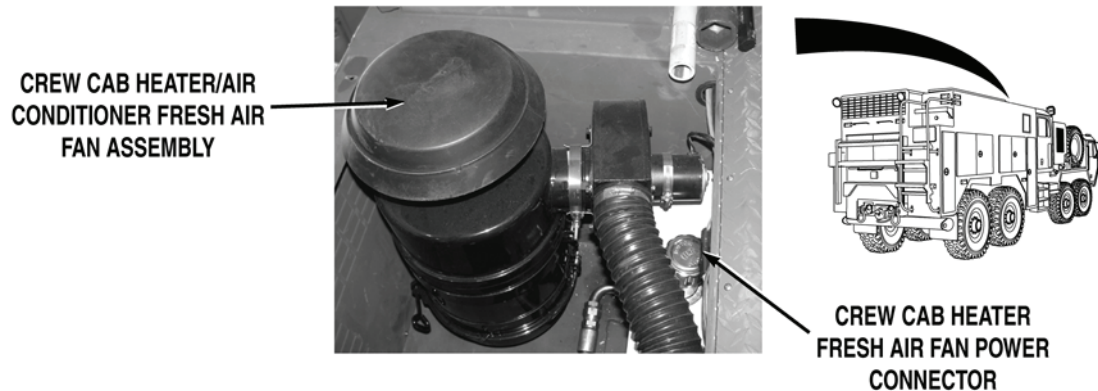

Step 3. Check if crew cab heater/air conditioner fresh air fan assembly is free from blockage.

If crew cab heater/air conditioner fresh air fan assembly is blocked, clear blockage.

Step 4. Check if crew cab heater fresh air fan power connector is connected.

- a. If crew cab heater fresh air fan power connector is not connected, connect it.
- b. If problem still exists, notify Supervisor.

**END OF TASK**

**FOLLOW-ON MAINTENANCE**

Remove wheel chocks (TM 9-2320-347-10)

**END OF TASK**

**END OF WORK PACKAGE**

---

**OPERATOR LEVEL MAINTENANCE**
**DECK LIGHTS, CREW CAB DOME LIGHTS, CLEARANCE LIGHTS, AND COMPARTMENT LIGHTS DO NOT OPERATE**

---

**INITIAL SETUP:****References**

WP 0004  
WP 0007

**Equipment Conditions**

Water pump engine OFF (WP 0022)  
Engine OFF (TM 9-2320-347-10)  
Wheels chocked (TM 9-2320-347-10)

---

**MALFUNCTION****TEST OR INSPECTION****CORRECTIVE ACTION**

---

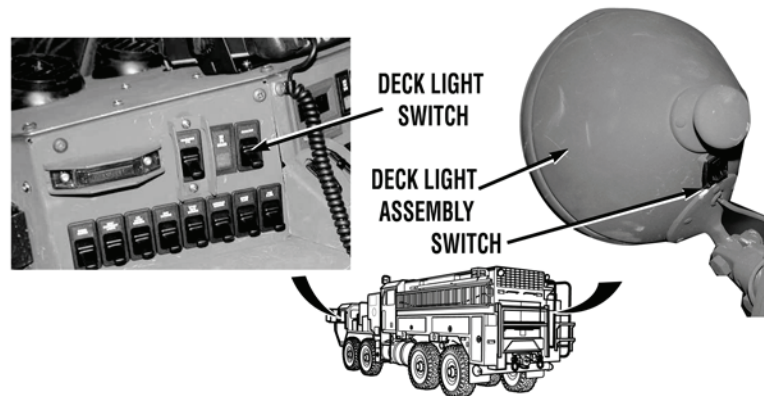
**DECK LIGHTS, CREW CAB DOME LIGHTS, CLEARANCE LIGHTS, AND COMPARTMENT LIGHTS DO NOT OPERATE**

Step 1. Turn battery disconnect switch to ON position (WP 0007). Turn Service Drive Lights On (TM 9-2320-347-10). Check if deck light is on.

If deck light is not on, place DECKLIGHT switch to ON position.

Step 2. Check if switch on non-operating deck light assembly is in ON position.

- a. If deck light assembly switch is not in ON position, place switch in ON position.
- b. If problem still exists, notify Supervisor.

**MALFUNCTION**

**TEST OR INSPECTION**

**CORRECTIVE ACTION**

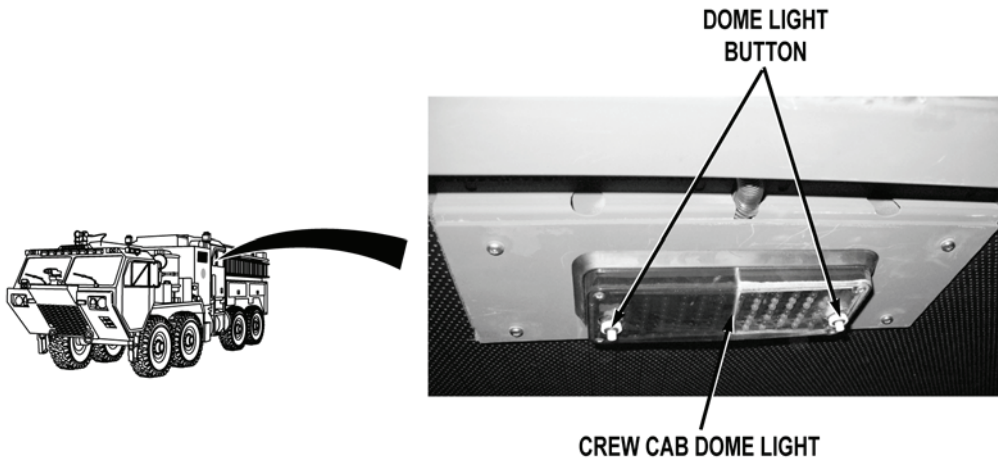

- Step 3. Check if crew cab dome light button is in ON position.
- a. If crew cab dome light is not in ON position, push crew cab dome light button.
  - b. If problem still exists, notify Supervisor.

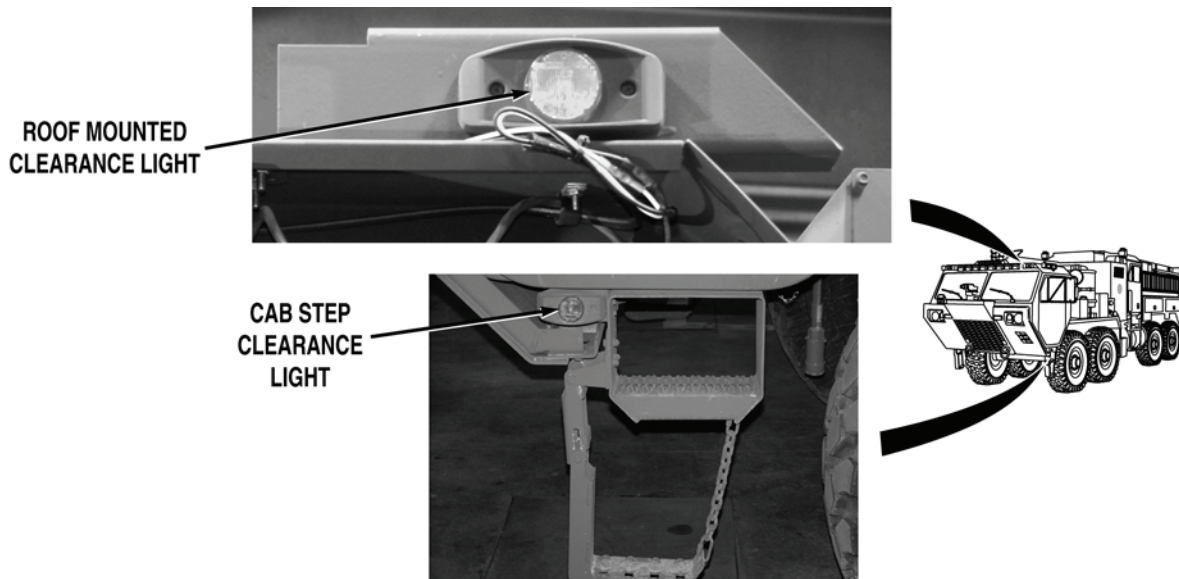

- Step 4. Check if clearance lights illuminate when Service Drive Lights are in ON position (TM 9-2320-347-10).
- a. If clearance lights do not illuminate, ensure blackout driver lights are not in ON position (TM 9-2320-347-10).
  - b. If problem still exists, notify Supervisor.



---

**MALFUNCTION****TEST OR INSPECTION****CORRECTIVE ACTION**

---

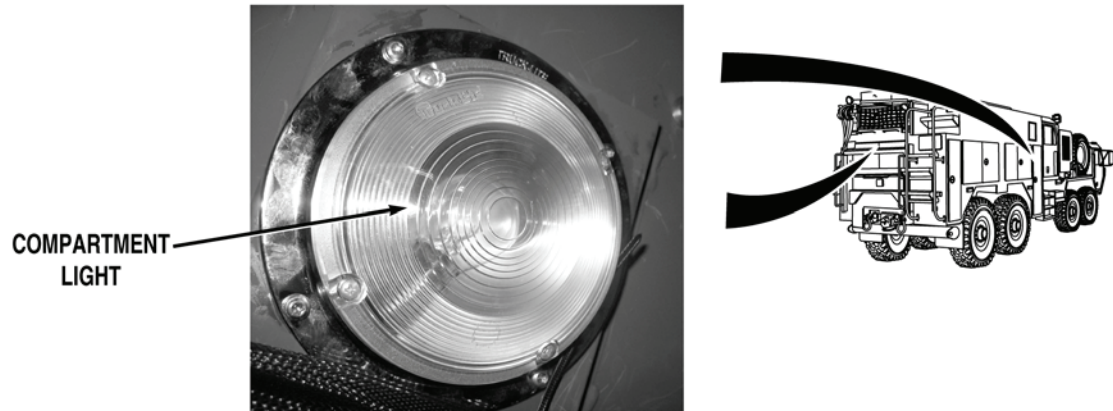

- Step 5. Check if compartment lights come on when Service Drive Lights are in ON position (TM 9-2320-347-10).
- a. If compartment lights do not come on, ensure blackout drive lights are not in ON position.
  - b. If problem still exists, notify Supervisor.

**END OF TASK****FOLLOW-ON MAINTENANCE**

Remove wheel chocks (TM 9-2320-347-10)

**END OF TASK****END OF WORK PACKAGE**



---

**OPERATOR LEVEL MAINTENANCE**
**DO NOT MOVE APPARATUS WHEN LIGHT IS ON INDICATOR FLASHES**

---

**INITIAL SETUP:****References**

WP 0007  
 WP 0010  
 WP 0011  
 WP 0018

**Equipment Conditions**

Water pump engine OFF (WP 0022)  
 Engine OFF (TM 9-2320-347-10)  
 Wheels chocked (TM 9-2320-347-10)

---

**MALFUNCTION****TEST OR INSPECTION****CORRECTIVE ACTION**

---

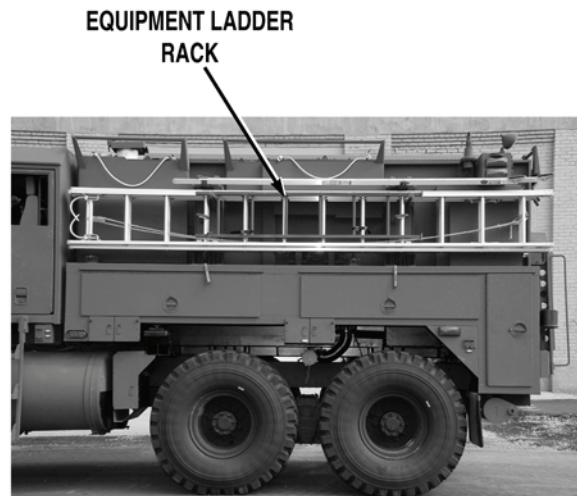
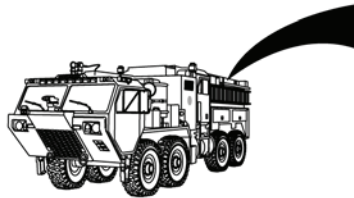
**DO NOT MOVE APPARATUS WHEN LIGHT IS ON INDICATOR FLASHES**

- Step 1. Turn battery disconnect switch to ON position (WP 0007). Turn ENGINE switch to ON position (TM 9-2320-347-10), do not start vehicle. Turn Service Drive Lights On (TM 9-2320-347-10). Check if equipment (ladder) rack is in fully raised position.

If equipment (ladder) rack is not in fully raised position, put equipment ladder rack in fully raised position (WP 0011).

---

**MALFUNCTION****TEST OR INSPECTION****CORRECTIVE ACTION**

---

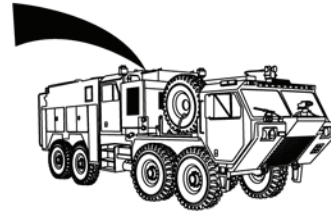
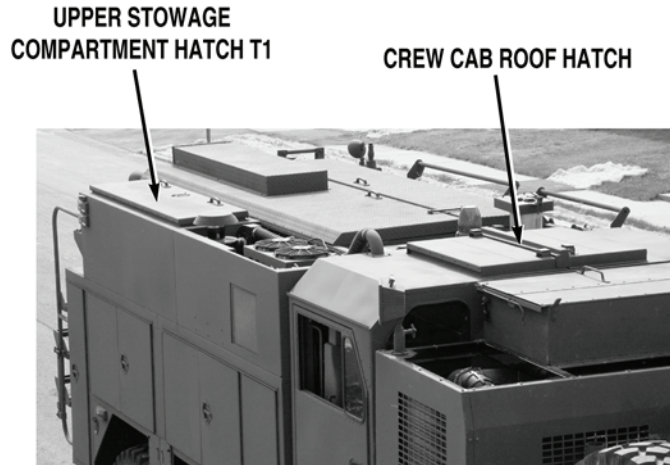

Step 2. Check if crew cab roof hatch is in open position.

If crew cab roof hatch is in open position, close crew cab roof hatch (WP 0018).

Step 3. Check if upper stowage compartment hatch T1 is open.

If upper stowage compartment hatch T1 is open, close upper stowage compartment hatch T1 (WP 0010).

---

**MALFUNCTION****TEST OR INSPECTION****CORRECTIVE ACTION**

---

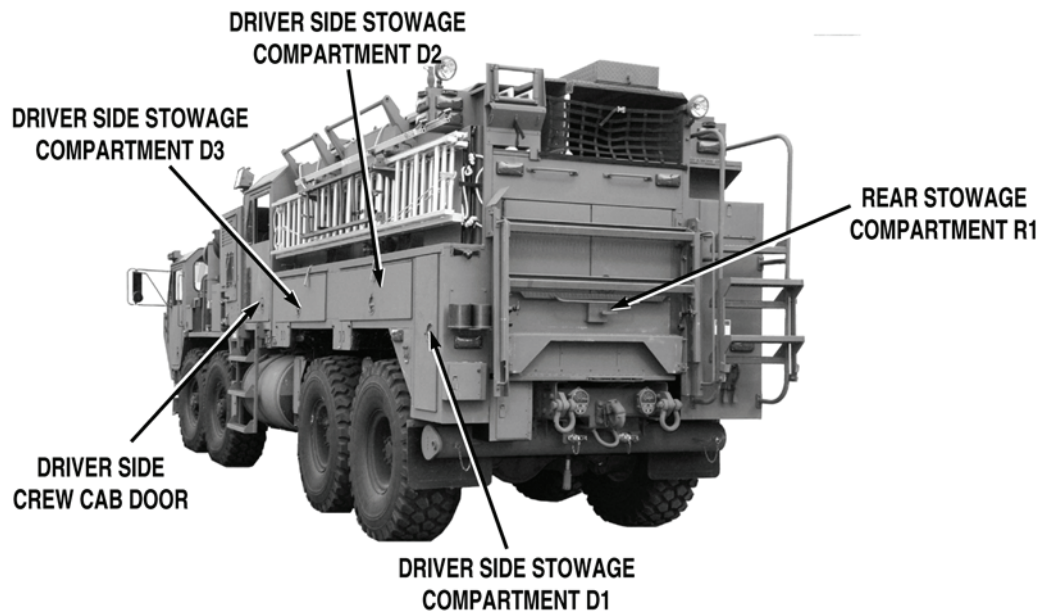

Step 4. Check if driver side crew cab door is open.

If driver side crew cab door is open, close driver side crew cab door.

Step 5. Check if driver side stowage compartment D1, D2, or D3 doors are open.

If driver side stowage compartment D1, D2, or D3 doors are open, close driver side stowage compartment D1, D2, or D3 doors (WP 0010).

Step 6. Check if rear stowage compartment R1 door is open.

If rear stowage compartment R1 door is open, close rear stowage compartment R1 door (WP 0010).

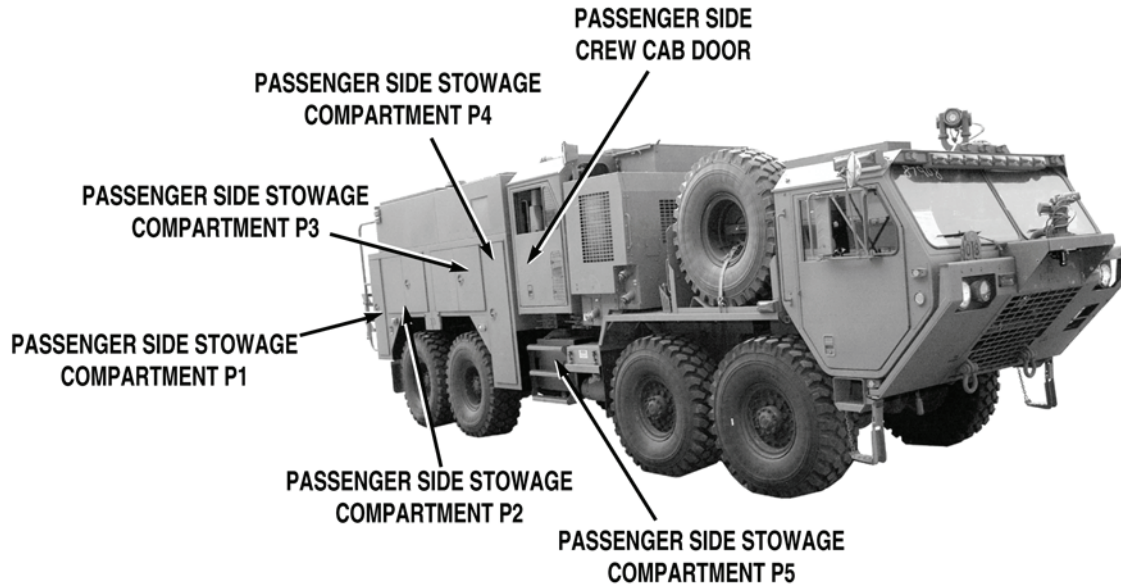
**MALFUNCTION****TEST OR INSPECTION****CORRECTIVE ACTION**

Step 7. Check if passenger side crew cab door is open.

If passenger side crew cab door is open, close passenger side crew cab door.

Step 8. Check if passenger side stowage compartment P1, P2, P3, P4, or P5 doors are open.

- a. If passenger side stowage compartment P1, P2, P3, P4, or P5 doors are open, close passenger side stowage compartment P1, P2, P3, P4, or P5 doors (WP 0010).
- b. If passenger side stowage compartment P1, P2, P3, P4, or P5 doors are closed and DO NOT MOVE APPARATUS WHEN LIGHT IS ON indicator continues to flash, notify Supervisor.

**END OF TASK****FOLLOW-ON MAINTENANCE**

1. Turn ENGINE switch to OFF position (TM 9-2320-347-10)
2. Turn battery disconnect switch to OFF position (WP 0007)
3. Remove wheel chocks (TM 9-2320-347-10)

**END OF TASK****END OF WORK PACKAGE**

---

**OPERATOR LEVEL MAINTENANCE**
**EXTENDABLE FLOODLIGHTS DO NOT OPERATE**

---

**INITIAL SETUP:****References**

WP 0007  
WP 0021

**Equipment Conditions**

Water pump engine OFF (WP 0022)  
Engine OFF (TM 9-2320-347-10)  
Wheels chocked (TM 9-2320-347-10)

---

**MALFUNCTION****TEST OR INSPECTION****CORRECTIVE ACTION****EXTENDABLE FLOODLIGHTS DO NOT OPERATE**

- Step 1. Turn battery disconnect switch to ON position (WP 0007). Start engine (TM 9-2320-347-10). Start hydraulic generator (WP 0021). Check if 120 VAC outlets operate.

If all 120 VAC outlets do not operate, troubleshoot 120 VAC Outlet(s) Does Not Operate (WP 0051).

**NOTE**

Circuit breaker may be in ON position when tripped. To make sure circuit breaker is not tripped, reset circuit breaker by switching it to OFF position then back to ON position.

- Step 2. Check if circuit breaker 5 or 6 is tripped.
- a. If circuit breaker 5 or 6 is tripped, reset tripped circuit breaker.
  - b. If circuit breaker trips again, notify Supervisor.

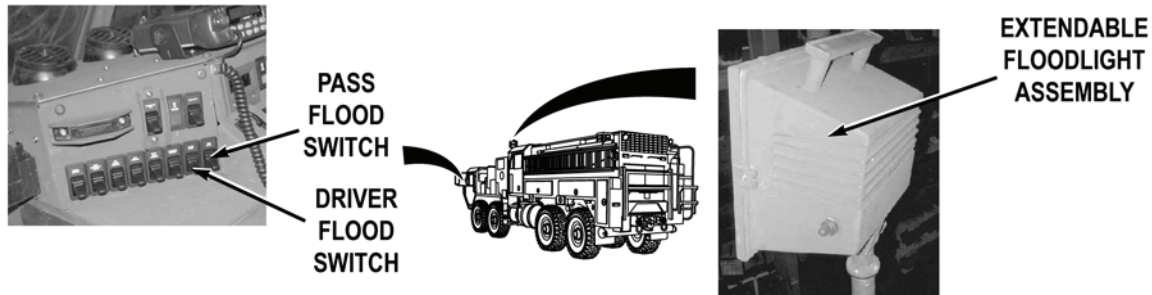
**MALFUNCTION****TEST OR INSPECTION****CORRECTIVE ACTION**

Step 3. If driver side extendable floodlight does not operate, check if DRIVER FLOOD switch in cab is in ON position.

If DRIVER FLOOD switch is not in ON position, place switch in ON position.

Step 4. If passenger side extendable floodlight does not operate, check if PASS FLOOD switch in cab in ON position.

If PASS FLOOD switch is not in ON position, place switch in ON position.

Step 5. Check if switch on non-operating extendable floodlight assembly is in ON position.

- a. If extendable floodlight assembly switch is not in ON position, place switch in ON position.
- b. If problem still exists, notify Supervisor.

**END OF TASK****FOLLOW-ON MAINTENANCE**

Remove wheel chocks (TM 9-2320-347-10)

**END OF TASK****END OF WORK PACKAGE**



**OPERATOR LEVEL MAINTENANCE**

**STREAMLIGHT BATTERY CHARGER(S) DOES NOT CHARGE BATTERIES**

**INITIAL SETUP:**

**References**

WP 0405

**Equipment Conditions**

Water pump engine OFF (WP 0022)

**Equipment Conditions (continued)**

Engine OFF (TM 9-2320-347-10)

Wheels chocked (TM 9-2320-347-10)

**MALFUNCTION**

**TEST OR INSPECTION**

**CORRECTIVE ACTION**

**STREAMLIGHT BATTERY CHARGER(S) DOES NOT CHARGE BATTERIES**

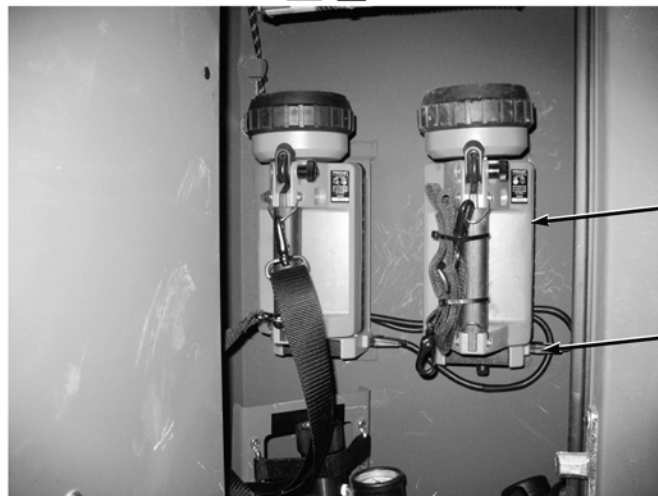
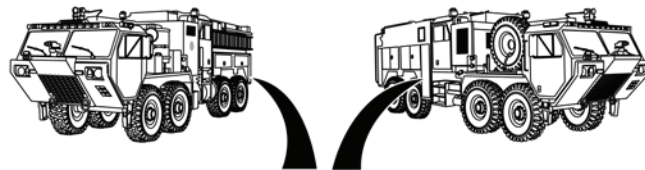

Step 1. Check if streamlight charger power cord is properly installed in streamlight battery charger.

If streamlight charger power cord is not properly installed in streamlight battery charger, reinstall streamlight charger power cord (WP 0405).

**MALFUNCTION****TEST OR INSPECTION****CORRECTIVE ACTION**

**BATTERY  
CHARGER  
CONNECTOR**

**BATTERY CHARGER  
CONNECTOR**



- Step 2. Check if streamlight is fully seated in streamlight battery charger.
- a. If streamlight is not fully seated in streamlight battery charger, reseal streamlight.
  - b. If streamlight is fully seated in streamlight battery charger, notify Supervisor.

**END OF TASK**

**FOLLOW-ON MAINTENANCE**

Remove wheel chocks (TM 9-2320-347-10)

**END OF TASK**

**END OF WORK PACKAGE**

**OPERATOR LEVEL MAINTENANCE**

**FOAM SYSTEM DOES NOT OPERATE**

**INITIAL SETUP:**

**Tools and Special Tools**

Tool Kit, General Mechanic's: Automotive  
(WP 0622, Item 27)

**References**

WP 0004  
WP 0019  
WP 0026

**References (continued)**

WP 0031  
WP 0035  
WP 0039

**Equipment Conditions**

Water pump engine OFF (WP 0022)  
Engine OFF (TM 9-2320-347-10)  
Wheels chocked (TM 9-2320-347-10)

**MALFUNCTION**

**TEST OR INSPECTION**

**CORRECTIVE ACTION**

**FOAM SYSTEM DOES NOT OPERATE**

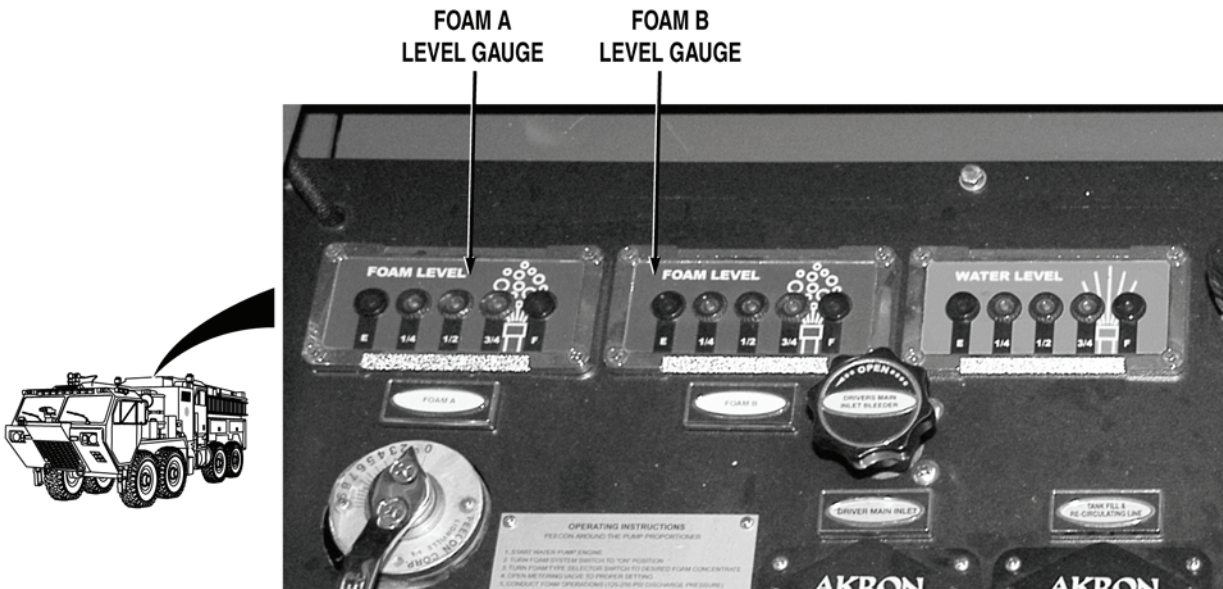
**MALFUNCTION****TEST OR INSPECTION****CORRECTIVE ACTION****WARNING**

Before operating foam system, personnel must familiarize themselves with all procedures and instructions regarding water pump, discharge devices, and foam making devices. Failure to comply may result in injury to personnel and/or damage to equipment.

**CAUTION**

Do not mix different types or brands of foam agent in foam cell or piping. Mixing of different foam agents (either type or manufacturer) may cause deterioration of foam agent, improper proportioning, and poor performance in a fire situation. Mixing of Class A and/or Class B and different types of foam agents may result in a chemical reaction which can create globules, which can clog orifices and cause system failure.

**NOTE**

Test should be done using both Foam A and Foam B separately from pump operator's panel.

- Step 1. Open pump operator's panel (WP 0019). Check pump operator's panel FOAM LEVEL gauge (WP 0004).

If foam level gauge indicates E (empty) (WP 0004), fill foam tank (WP 0031).

**MALFUNCTION**  
**TEST OR INSPECTION**  
**CORRECTIVE ACTION**

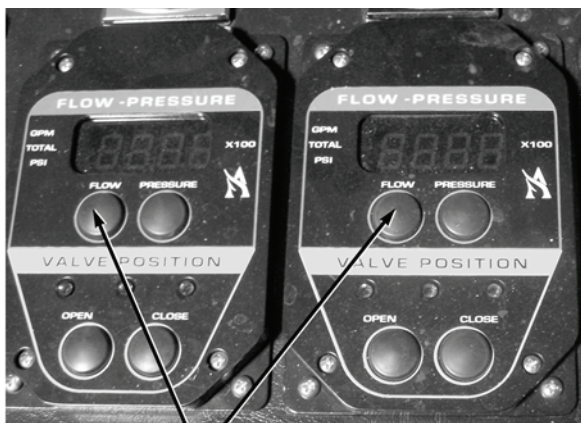

**SIDE DISCHARGE  
FLOW BUTTONS**

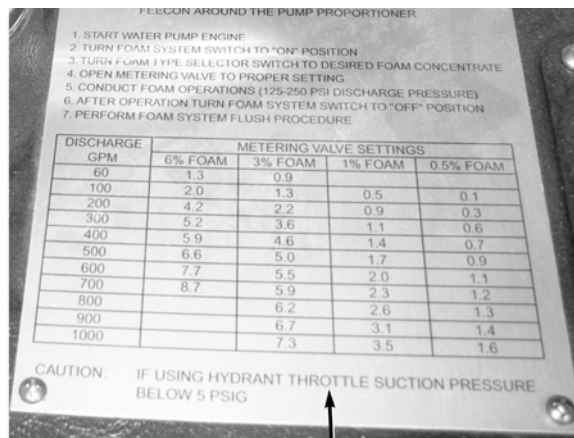

**MANUAL METERING  
CONTROL VALVE  
DATA PLATE**



**WARNING**



**Ensure PTO area is clear of personnel and obstructions before engaging PUMP PTO switch. Failure to comply may result in injury or death to personnel and/or damage to equipment.**

**NOTE**

Ensure system air pressure is at least 85 psi (586 kPa) during this procedure. System air pressure is required to activate valves.

- Step 2. Start engine (TM 9-2320-347-10). Set up system to pump from onboard water tank (WP 0026). When discharging from NO.1 DRIVER SIDE DISCHARGE or NO. 2 PASSENGER SIDE DISCHARGE, press FLOW button on valve control. Record GPM rate, using settings from manual metering control valve data plate, set manual metering valve to match discharge rate of flow. Operate bumper turret (WP 0035), ground sweeps (WP 0039), or side discharge. Check if foam is delivered when system is operated.
- a. If foam is delivered, problem has been corrected.
  - b. If Foam A or Foam B is not delivered from either discharge, notify Supervisor.

**MALFUNCTION**

**TEST OR INSPECTION**

**CORRECTIVE ACTION**

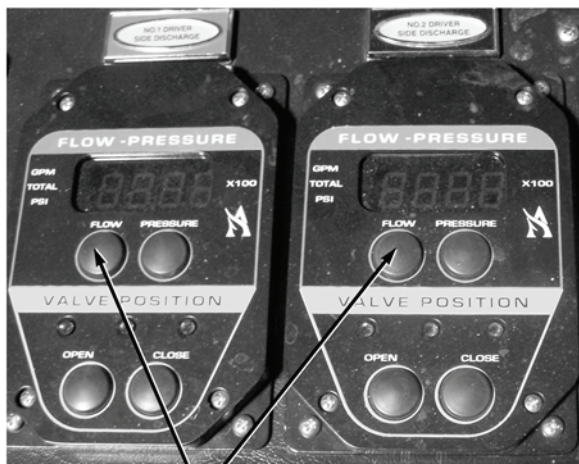

**SIDE DISCHARGE  
FLOW BUTTONS**

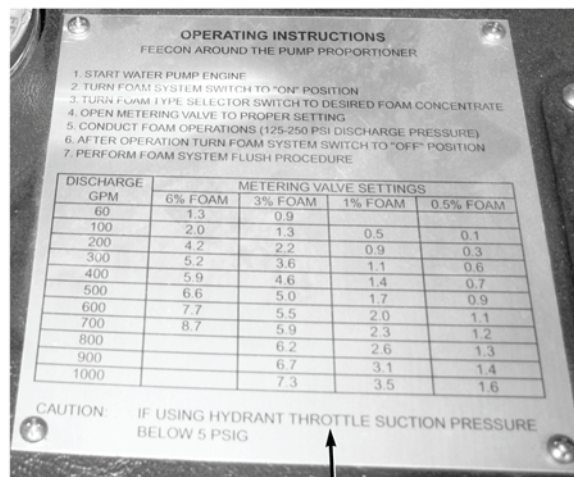

**MANUAL METERING  
CONTROL VALVE  
DATA PLATE**



Step 3. Start engine (TM 9-2320-347-10). Set up system to pump from onboard water tank (WP 0026). Put pump operator's panel FOAM SYSTEM switch to ON position (WP 0004). Put pump operator's panel FOAM tank SWITCH TO "A" position (WP 0004). When discharging from NO.1 DRIVER SIDE DISCHARGE or NO. 2 PASSENGER SIDE DISCHARGE, press FLOW button on valve control (WP 0004). Record GPM rate. Using settings from manual metering control valve data plate, set manual metering valve to match discharge rate of flow. Operate bumper turret (WP 0035), ground sweeps (WP 0039), or side discharge. Check if foam is delivered when system is operated. Put pump operator's panel FOAM SYSTEM switch of OFF position (WP 0004). Put FOAM FLUSH switch to ON position (WP 0004). Flush foam system (WP 0031). Put pump operator's panel FOAM SYSTEM switch to ON position (WP 0004). Put pump operator's panel FOAM TANK switch to "B" position (WP 0004). Repeat test procedures used for foam A.

- a. If foam is delivered, fault corrected.
- b. If foam is not delivered, notify Supervisor.

**END OF TASK**

**FOLLOW-ON MAINTENANCE**

Remove wheel chocks (TM 9-2320-347-10)

**END OF TASK**

**END OF WORK PACKAGE**

**OPERATOR LEVEL MAINTENANCE**

**PUMP ENGINE CRANKS BUT FAILS TO START**

**INITIAL SETUP:**

**References**

WP 0004  
WP 0007

**Equipment Conditions**

Water pump engine OFF (WP 0022)  
Engine OFF (TM 9-2320-347-10)  
Wheels chocked (TM 9-2320-347-10)

**MALFUNCTION**

**TEST OR INSPECTION**

**CORRECTIVE ACTION**

**PUMP ENGINE CRANKS BUT FAILS TO START**

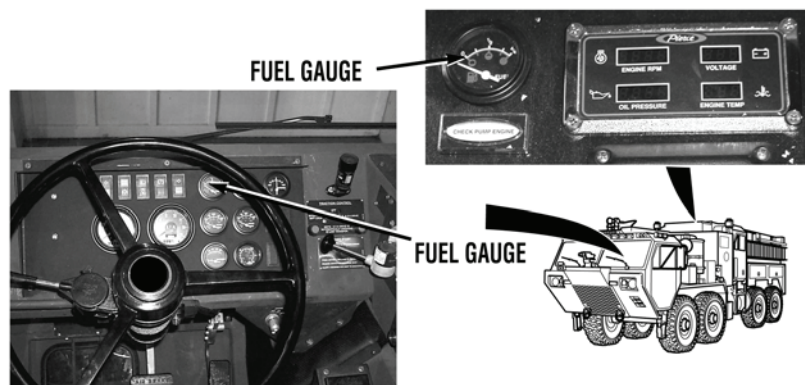

Step 1. Turn battery disconnect switch to ON position (WP 0007). Turn cab ENGINE START switch to ON position. Check cab or pump operator's panel fuel level gauge for presence of fuel (WP 0004).

If cab or pump operator's panel fuel level gauge indicates low fuel level, fill fuel tank (TM 9-2320-347-10).

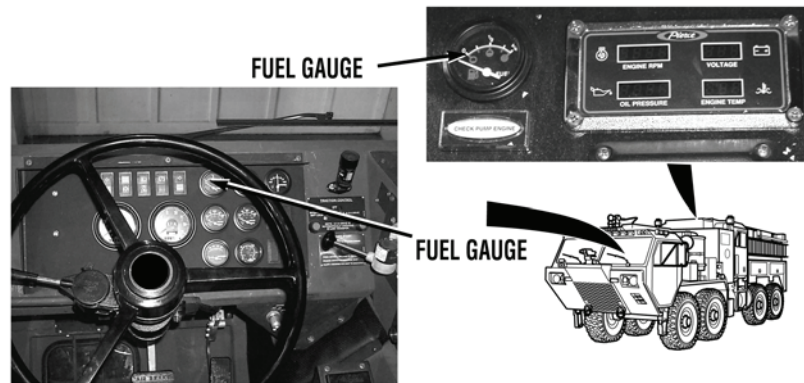
**MALFUNCTION****TEST OR INSPECTION****CORRECTIVE ACTION**

Step 2. Check fuel tank for presence of fuel.

- a. If no fuel is present, fill fuel tank (TM 9-2320-347-10).
- b. If problem still exists, notify Supervisor.

**END OF TASK****FOLLOW-ON MAINTENANCE**

Remove wheel chocks (TM 9-2320-347-10)

**END OF TASK****END OF WORK PACKAGE**



---

**OPERATOR MAINTENANCE**
**PUMP ENGINE GOVERNOR CONTROL DOES NOT OPERATE**

---

**INITIAL SETUP:****References**

WP 0004  
 WP 0007  
 WP 0022

**Equipment Conditions**

Water pump engine OFF (WP 0022)  
 Engine OFF (TM 9-2320-347-10)  
 Wheels chocked (TM 9-2320-347-10)

---

**MALFUNCTION****TEST OR INSPECTION****CORRECTIVE ACTION**

---

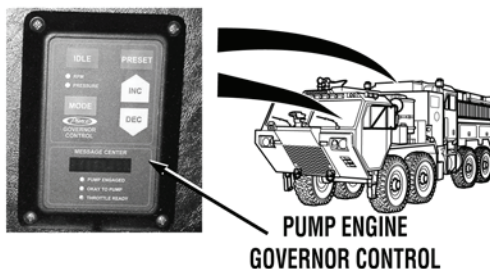
**PUMP ENGINE GOVERNOR CONTROL DOES NOT OPERATE**

- Step 1. Turn battery disconnect switch to ON position (WP 0007). Start water pump engine (WP 0022). If operating governor control from cab, check if operator's panel governor control is active (WP 0004).

If pump operator's panel governor control is active, select MODE switch to deactivate governor control. Then select cab governor control MODE switch to active cab governor control.

- Step 2. If operating governor control from pump operator's panel, check if cab governor control is active.

If cab governor control is active, select MODE switch to deactivate governor control, then select pump operator's panel governor control MODE switch to activate pump operator's panel governor control.

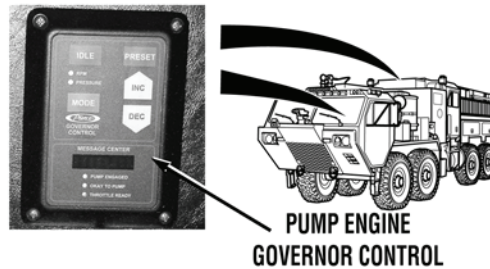
**MALFUNCTION****TEST OR INSPECTION****CORRECTIVE ACTION**

Step 3. Check if INTAKE or OPERATOR is displayed on active governor control.

If INTAKE or OPERATOR is displayed on active governor control, pump output pressure dropped and the governor control was not able to maintain pressure within four seconds. Correct problem and select DEC, INC, or PRESET switch to activate governor control and set pressure.

Step 4. Check if LO SUPPLY is displayed on active governor control, pump output pressure dropped below 30 psi (207 kPa) for more than five seconds. Correct problem and select MODE switch to activate governor control.

If problem still exists, notify Supervisor.

**END OF TASK****FOLLOW-ON MAINTENANCE**

Remove wheel chocks (TM 9-2320-347-10)

**END OF TASK****END OF WORK PACKAGE**

**OPERATOR LEVEL MAINTENANCE**

**PUMP ENGINE RUNS ROUGH OR SHUTS DOWN WHILE RUNNING**

**INITIAL SETUP:**

**References**

- WP 0004
- WP 0007
- WP 0061

**Equipment Conditions**

- Water pump engine OFF (WP 0022)
- Engine OFF (TM 9-2320-347-10)
- Wheels chocked (TM 9-2320-347-10)

**MALFUNCTION**

**TEST OR INSPECTION**

**CORRECTIVE ACTION**

**PUMP ENGINE RUNS ROUGH OR SHUTS DOWN WHILE RUNNING**

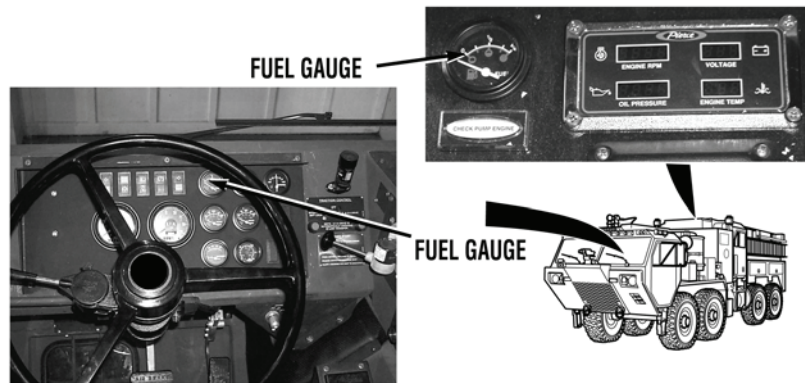

Step 1. Turn battery disconnect switch to ON position (WP 0007). Turn cab ENGINE START switch to ON position (TM 9-2320-347-10). Check cab or pump operator's panel fuel level gauge for presence of fuel (WP 0004).

If cab or pump operator's panel fuel level gauge indicates low fuel level, fill fuel tank (TM 9-2320-347-10).



Step 2. Check fuel tank for presence of fuel (WP 0061).

If fuel level is low, fill fuel tank (TM 9-2320-347-10).

---

**MALFUNCTION****TEST OR INSPECTION****CORRECTIVE ACTION**

---

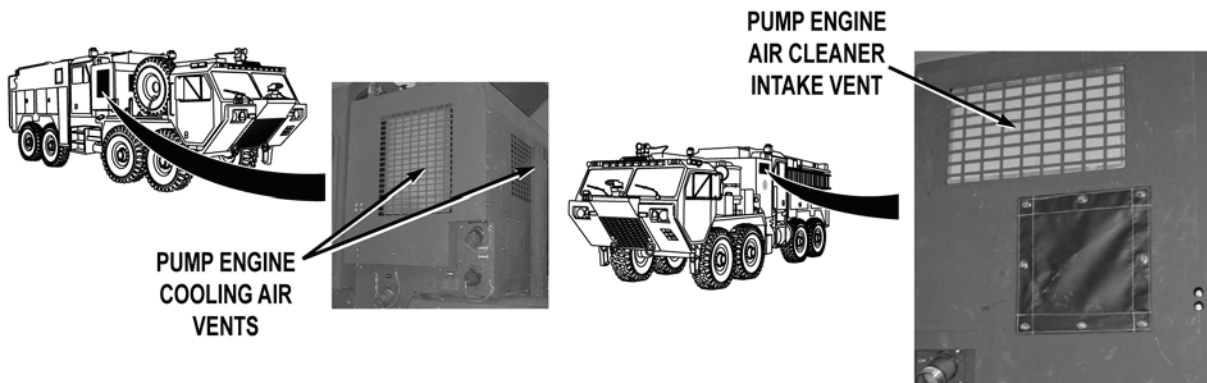

Step 3. Check pump engine air cleaner intake vent for blockage.

If pump engine air cleaner intake vent is blocked, clear blockage.

Step 4. Check pump engine cooling air vents for blockage.

- a. If pump engine air cleaner intake vents are blocked, clear blockage.
- b. If pump engine still runs rough or shuts down while running, notify Supervisor.

**END OF TASK**

**FOLLOW-ON MAINTENANCE**

Remove wheel chocks (TM 9-2320-347-10)

**END OF TASK**

**END OF WORK PACKAGE**

**OPERATOR LEVEL MAINTENANCE**

**PUMP DOES NOT PRIME**

**INITIAL SETUP:**

**References**

- WP 0020
- WP 0023
- WP 0025
- WP 0027

**Equipment Conditions**

- Water pump engine OFF (WP 0022)
- Engine OFF (TM 9-2320-347-10)
- Wheels chocked (TM 9-2320-347-10)

**MALFUNCTION**

**TEST OR INSPECTION**

**CORRECTIVE ACTION**

**PUMP DOES NOT PRIME**

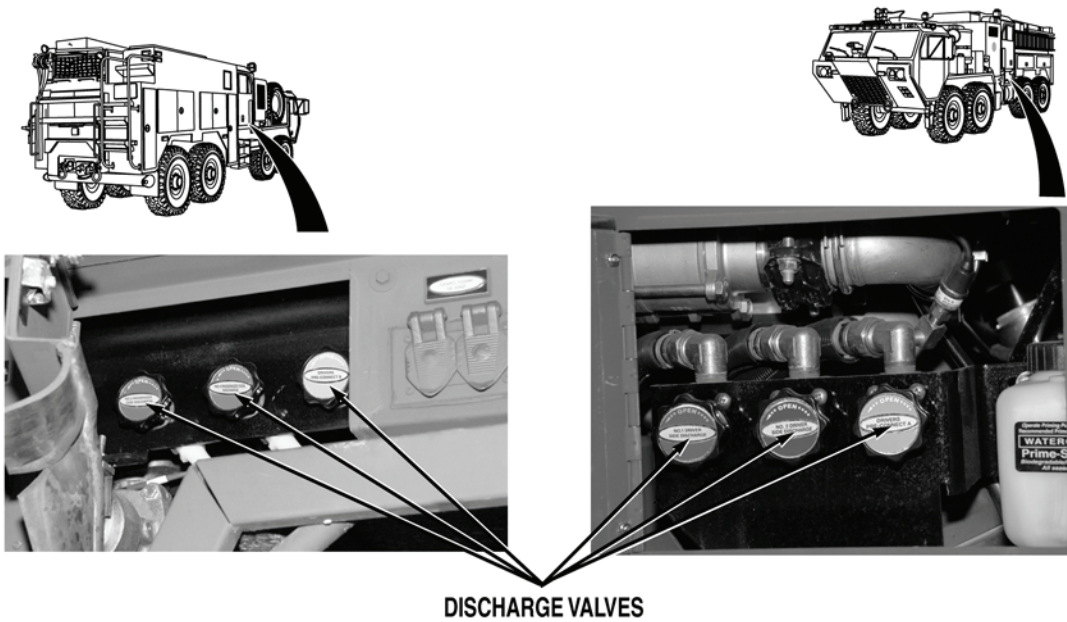

Step 1. Check if all discharge valves are closed (WP 0004).

If discharge valve is open, close it.

**MALFUNCTION**  
**TEST OR INSPECTION**  
**CORRECTIVE ACTION**

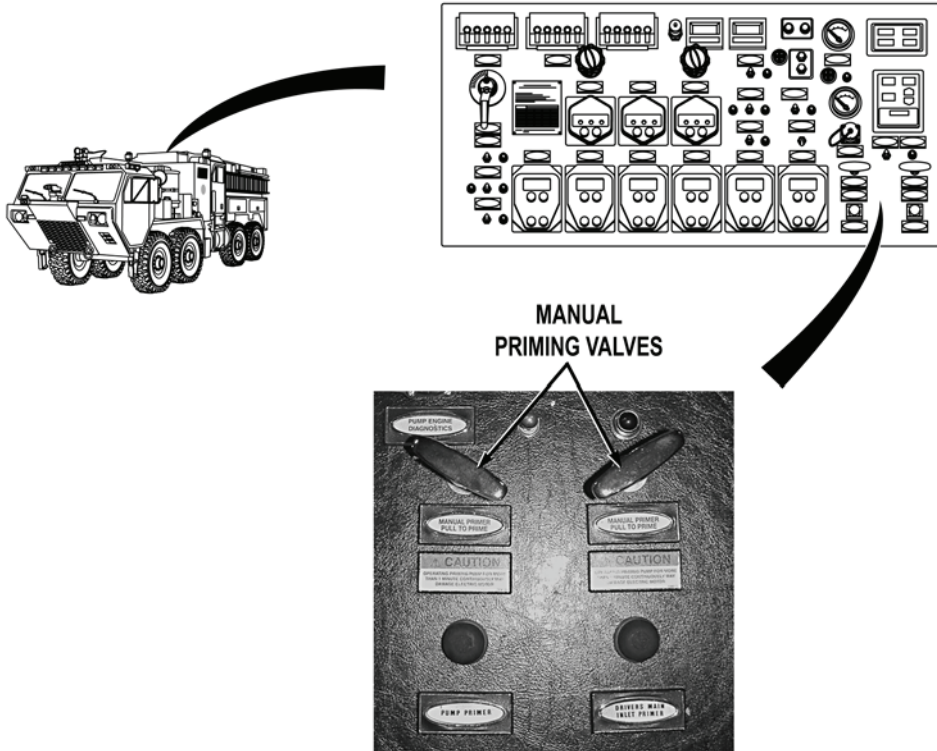

- Step 2. Check if manual priming valve is closed (WP 0023).  
 If manual discharge valve is open, close it.

**MALFUNCTION**  
**TEST OR INSPECTION**  
**CORRECTIVE ACTION**



CAB WATER  
 LEVEL GAUGE



PUMP OPERATOR'S PANEL  
 WATER LEVEL GAUGE

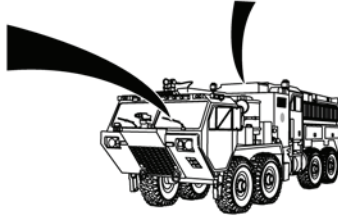

- Step 3. If pumping from water tank, check water level in tank.  
 If water level is low, fill tank (WP 0020).
- Step 4. If pumping from draft, check placement of suction hose (WP 0025).  
 If suction hose is not placed correctly, reposition suction hose.
- Step 5. If pumping from draft, make sure vertical height from end of suction valve to pump is not more than 10 ft. (3 m).  
 If vertical height is more than 10 ft. (3 m), reposition vehicle to reduce vertical height.

**MALFUNCTION**

**TEST OR INSPECTION**

**CORRECTIVE ACTION**

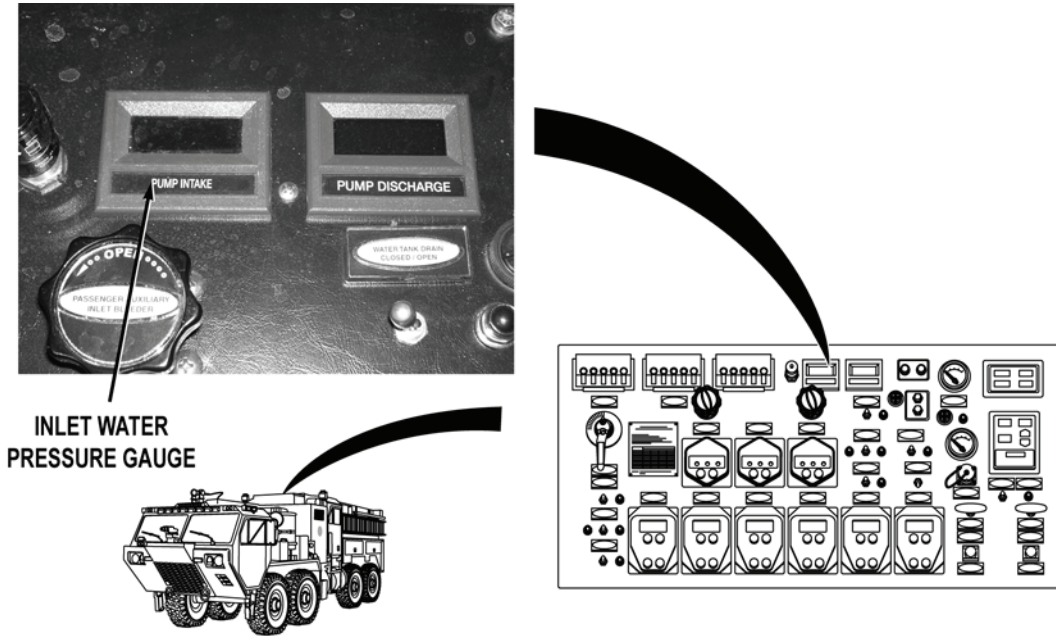

Step 6. If pumping from hydrant, check if inlet water pressure is present (WP 0027).

If water pressure is not present, correct problem.



---

**MALFUNCTION**  
**TEST OR INSPECTION**  
**CORRECTIVE ACTION**

---

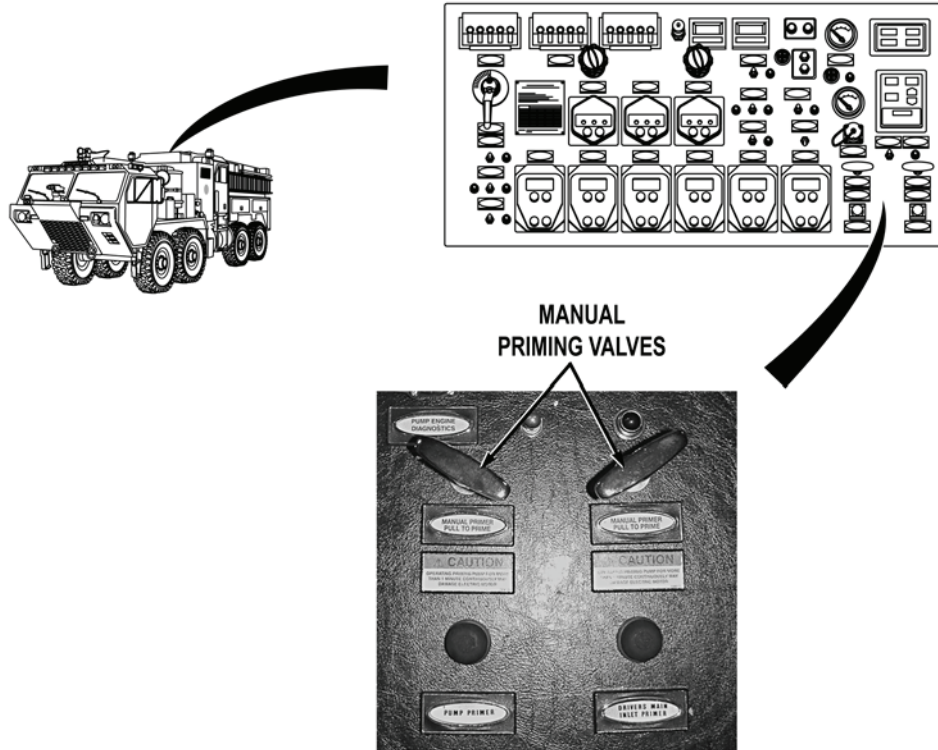

Step 7. If problem still exists, use manual pump priming system to prime pump, and notify Supervisor.

**END OF TASK**

**FOLLOW-ON MAINTENANCE**

Remove wheel chocks (TM 9-2320-347-10)

**END OF TASK**

**END OF WORK PACKAGE**



**OPERATOR LEVEL MAINTENANCE**

**PUMP LOSES PRIME**

**INITIAL SETUP:**

**References**

- WP 0004
- WP 0007
- WP 0020
- WP 0022
- WP 0023
- WP 0025
- WP 0026

**References (continued)**

- WP 0027
- WP 0064

**Equipment Conditions**

- Water pump engine OFF (WP 0022)
- Engine OFF (TM 9-2320-347-10)
- Wheels chocked (TM 9-2320-347-10)

**MALFUNCTION**

**TEST OR INSPECTION**

**CORRECTIVE ACTION**

**PUMP LOSES PRIME**

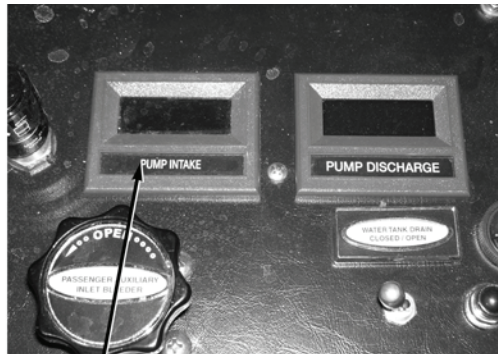

**INLET WATER PRESSURE GAUGE**

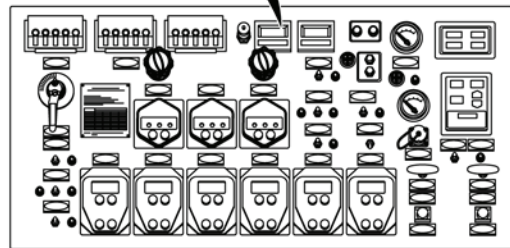

Step 1. Turn battery disconnect switch to ON position (WP 0007). Start water pump engine (WP 0022). If pumping from hydrant or in relay (WP 0027), check if inlet water pressure is present.

If inlet water pressure is not present, correct water supply problem and go to Step 6 or notify Supervisor.

**MALFUNCTION**

**TEST OR INSPECTION**

**CORRECTIVE ACTION**



CAB WATER LEVEL GAUGE



PUMP OPERATOR'S PANEL WATER LEVEL GAUGE

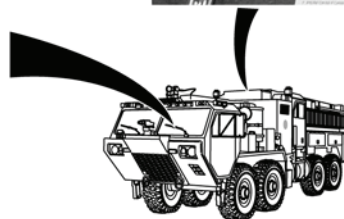

Step 2. If pumping from onboard water tank (WP 0026), check water tank level using cab or pump operator's panel WATER LEVEL gauge (WP 0004).

If water level is low, fill tank (WP 0020) and go to Step 6.

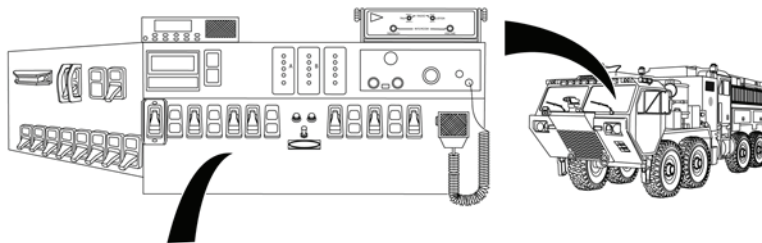

START PUMP STOP SWITCH

TANK TO PUMP INDICATOR LIGHT

Step 3. If pumping from onboard water tank (WP 0026), check if personnel cab TANK TO PUMP indicator is illuminated (WP 0004).

**MALFUNCTION****TEST OR INSPECTION****CORRECTIVE ACTION**

If indicator is not illuminated, put TANK TO PUMP switch to OPEN position (WP 0004) and release. If indicator does not remain illuminated when switch is released, notify Supervisor.

Step 4. If pumping from draft (WP 0025), check if suction hose is free from blockage.

If suction hose is blocked, removed blockage and go to Step 6.

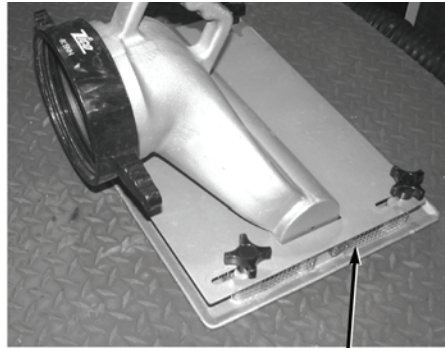

**STRAINER**



Step 5. If pumping from draft (WP 0025), check if suction hose is placed so vertical height between suction hose strainer and water pump is not more than 10 ft. (3 m).

If vertical height between suction hose strainer and water pump is more than 10 ft. (3 m), reposition vehicle to reduce vertical height and go to Step 6.

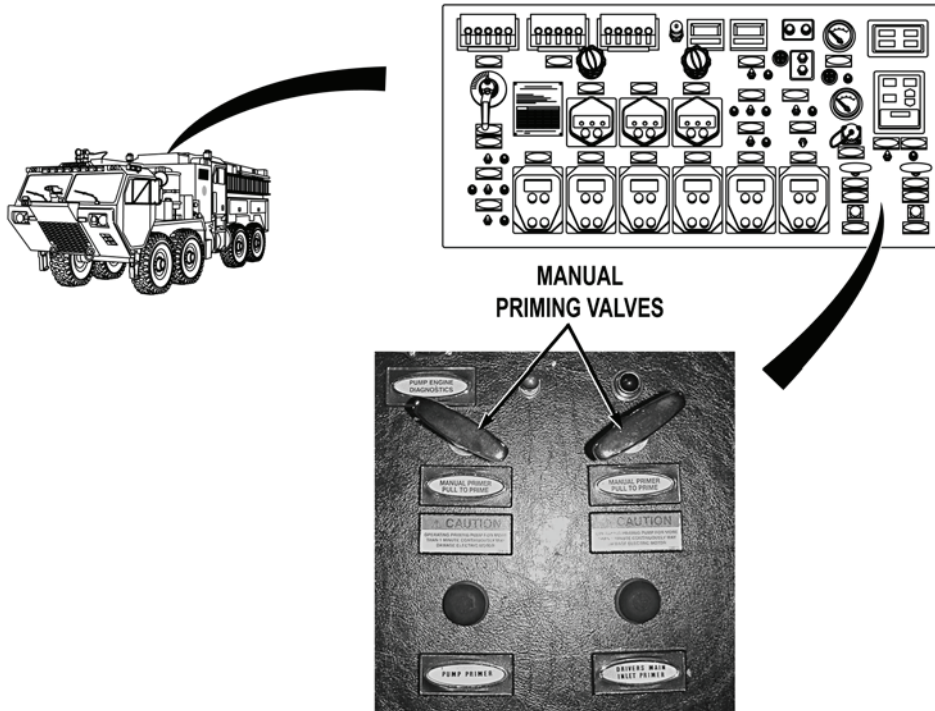
**MALFUNCTION****TEST OR INSPECTION****CORRECTIVE ACTION**

- Step 6. Operate primer system in manual mode, check if system can be primed (WP 0023).  
 If system does not prime, troubleshoot Pump Does Not Prime (WP 0064).
- Step 7. Operate system per SOP. Monitor system for reoccurrence of fault.
- a. If fault does not reoccur, complete mission per SOP and notify Supervisor.
  - b. If fault reoccurs, notify Supervisor.

**END OF TASK****FOLLOW-ON MAINTENANCE**

Remove wheel chocks (TM 9-2320-347-10)

**END OF TASK****END OF WORK PACKAGE**

**OPERATOR LEVEL MAINTENANCE**

**DRAIN VALVES LEAKING DURING PUMPING OPERATIONS**

**INITIAL SETUP:**

**References**

WP 0004

**Equipment Conditions**

Water pump engine OFF (WP 0022)

Engine OFF (TM 9-2320-347-10)

Wheels chocked (TM 9-2320-347-10)

**MALFUNCTION**

**TEST OR INSPECTION**

**CORRECTIVE ACTION**

**DRAIN VALVES LEAKING DURING PUMPING OPERATIONS**

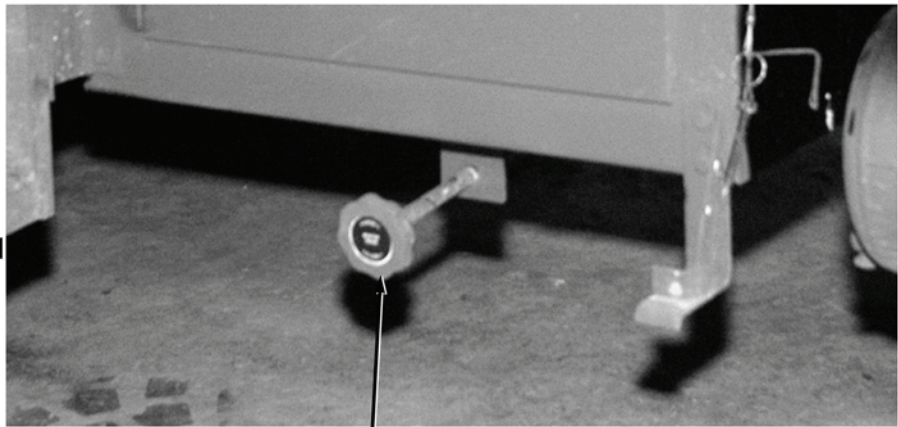
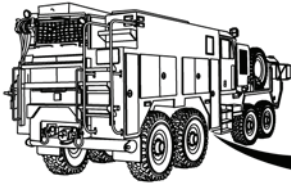

**MASTER DRAIN  
VALVE**

Step 1. Check if master drain valve is closed (WP 0004).

If master drain valve is open, close it (WP 0004).

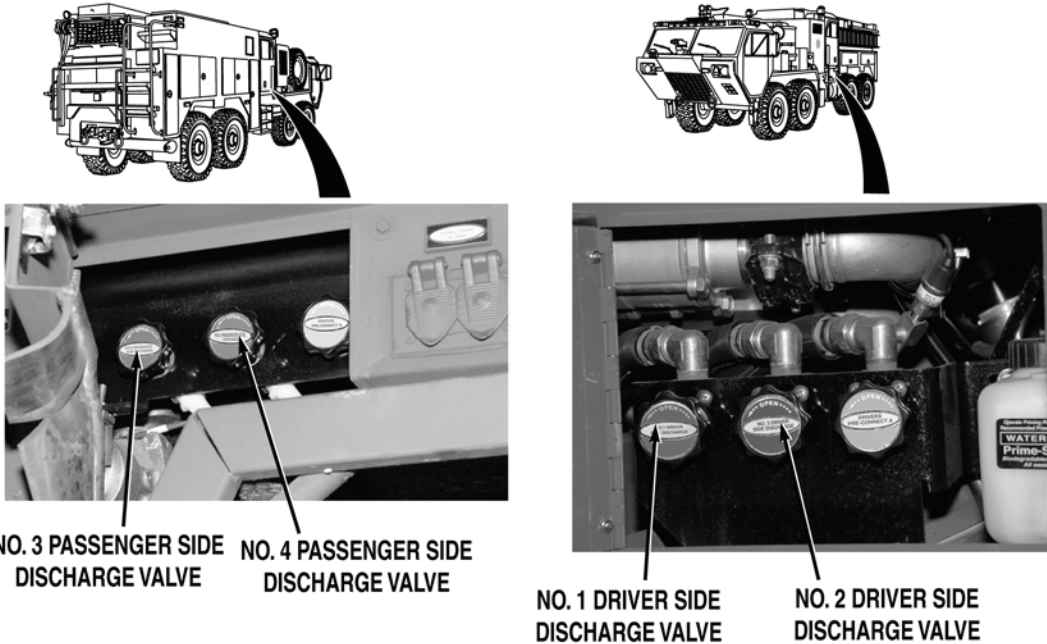
**MALFUNCTION****TEST OR INSPECTION****CORRECTIVE ACTION**

Step 2. Check if discharge drain valves are closed (WP 0004).

- a. If discharge drain valves are open, close them (WP 0004).
- b. If discharge drain valves are closed and still leak, notify Supervisor.

**END OF TASK****FOLLOW-ON MAINTENANCE**

Remove wheel chocks (TM 9-2320-347-10)

**END OF TASK****END OF WORK PACKAGE**



**OPERATOR LEVEL MAINTENANCE**

**HANDHELD RADIO BATTERY CHARGER(S) DOES NOT CHARGE BATTERIES**

**INITIAL SETUP:**

**References**  
WP 0406

**Equipment Conditions**  
Water pump engine OFF (WP 0022)  
Engine OFF (TM 9-2320-347-10)  
Wheels chocked (TM 9-2320-347-10)

**MALFUNCTION**

**TEST OR INSPECTION**

**CORRECTIVE ACTION**

**HANDHELD RADIO BATTERY CHARGER(S) DOES NOT CHARGE BATTERIES**

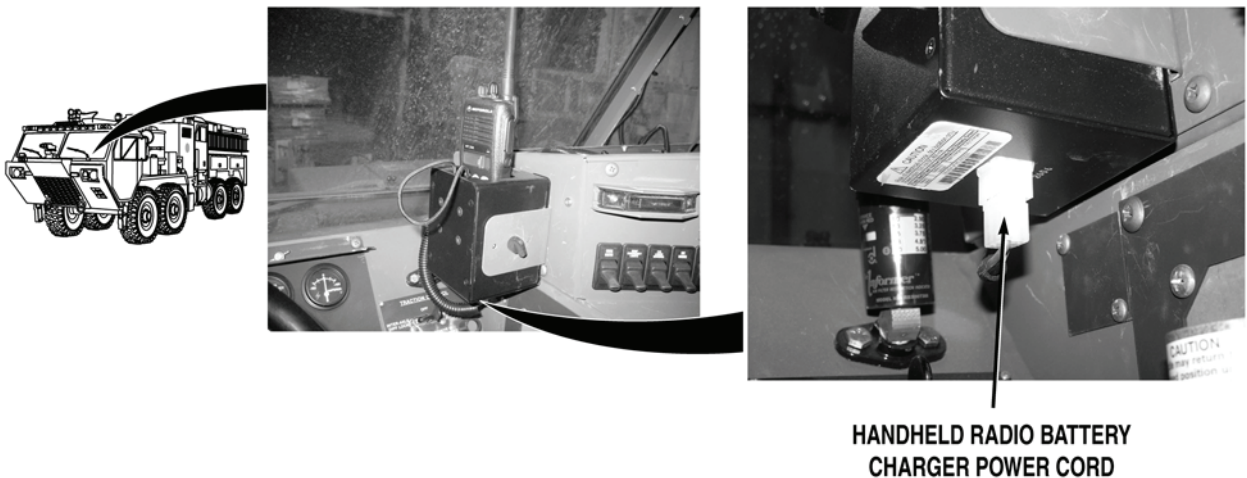

**HANDHELD RADIO BATTERY  
CHARGER POWER CORD**

Step 1. Check if handheld radio battery charger power cord is properly connected to handheld radio battery charger.

If handheld radio battery charger power cord is not properly connected to handheld radio battery charger, reconnect cord (WP 0406).

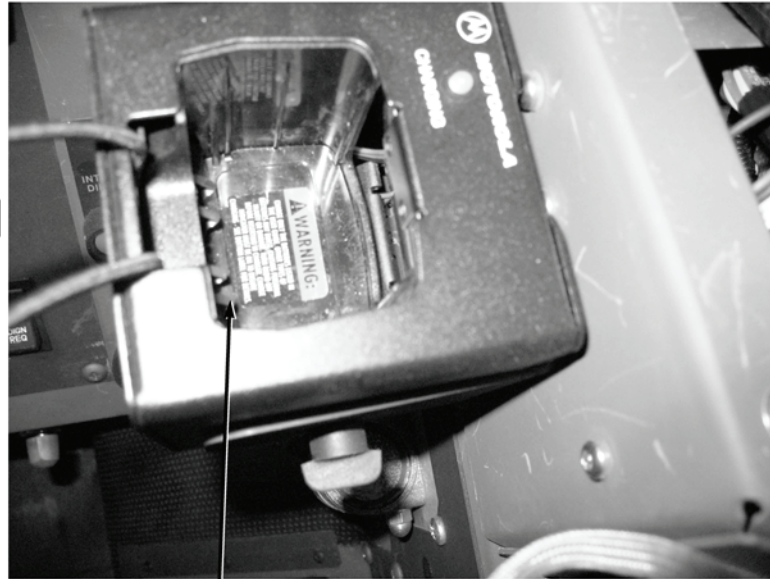
**MALFUNCTION****TEST OR INSPECTION****CORRECTIVE ACTION**

**RADIO BATTERY  
CHARGER SEAT**

- Step 2. Check if handheld radio is fully seated in handheld radio battery charger.
- a. If handheld radio is not fully seated in handheld radio battery charger, reseal radio.
  - b. If handheld radio is fully seated in handheld radio battery charger, notify Supervisor.

**END OF TASK**

**FOLLOW-ON MAINTENANCE**

Remove wheel chocks (TM 9-2320-347-10)

**END OF TASK**

**END OF WORK PACKAGE**

**OPERATOR LEVEL MAINTENANCE**

**WARNING LIGHTS DO NOT OPERATE**

**INITIAL SETUP:**

**References**  
WP 0004

**Equipment Conditions**  
Water pump engine OFF (WP 0022)  
Engine OFF (TM 9-2320-347-10)  
Wheels chocked (TM 9-2320-347-10)

**MALFUNCTION**

**TEST OR INSPECTION**

**CORRECTIVE ACTION**

**WARNING LIGHTS DO NOT OPERATE**

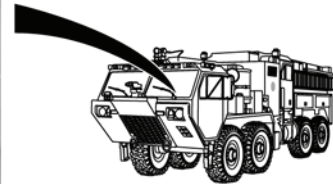

**EMERG MASTER SWITCH**

- Step 1. Check if vehicle service drive lights are on (not in blackout mode) (TM 9-2320-347-10).  
If service drive lights are not on, Turn Service Drive Lights On (TM 9-2320-347-10).
- Step 2. Check if EMERG MASTER switch is in on position (WP 0004).  
If switch is not in on position, put EMERG MASTER switch to on position (WP 0004).

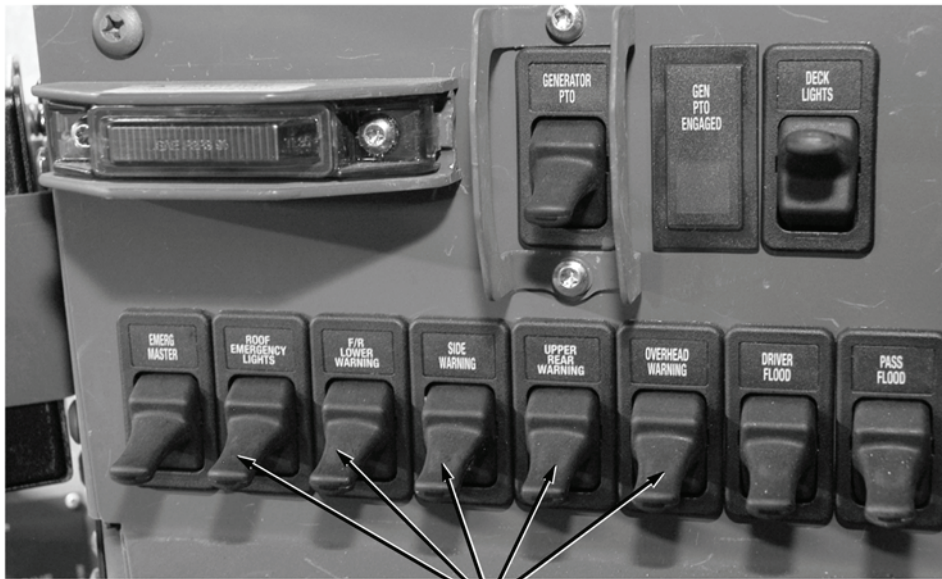
**MALFUNCTION****TEST OR INSPECTION****CORRECTIVE ACTION**

**WARNING LIGHT  
SWITCHES**

- Step 3. Check if selected warning light switch is in on position (WP 0004).
- a. If switch is not in on position, put switch to on position (WP 0004).
  - b. If switch is in on position, notify Supervisor.

**END OF TASK**

**FOLLOW-ON MAINTENANCE**

Remove wheel chocks (TM 9-2320-347-10)

**END OF TASK**

**END OF WORK PACKAGE**

---

**OPERATOR LEVEL MAINTENANCE**

**DISCHARGES HAVE ABNORMAL WATER STREAMS**

---

**INITIAL SETUP:**

**Equipment Conditions**

Water pump engine OFF (WP 0022)

Engine OFF (TM 9-2320-347-10)

Wheels chocked (TM 9-2320-347-10)

---

**MALFUNCTION**

**TEST OR INSPECTION**

**CORRECTIVE ACTION**

---

**DISCHARGES HAVE ABNORMAL WATER STREAMS**

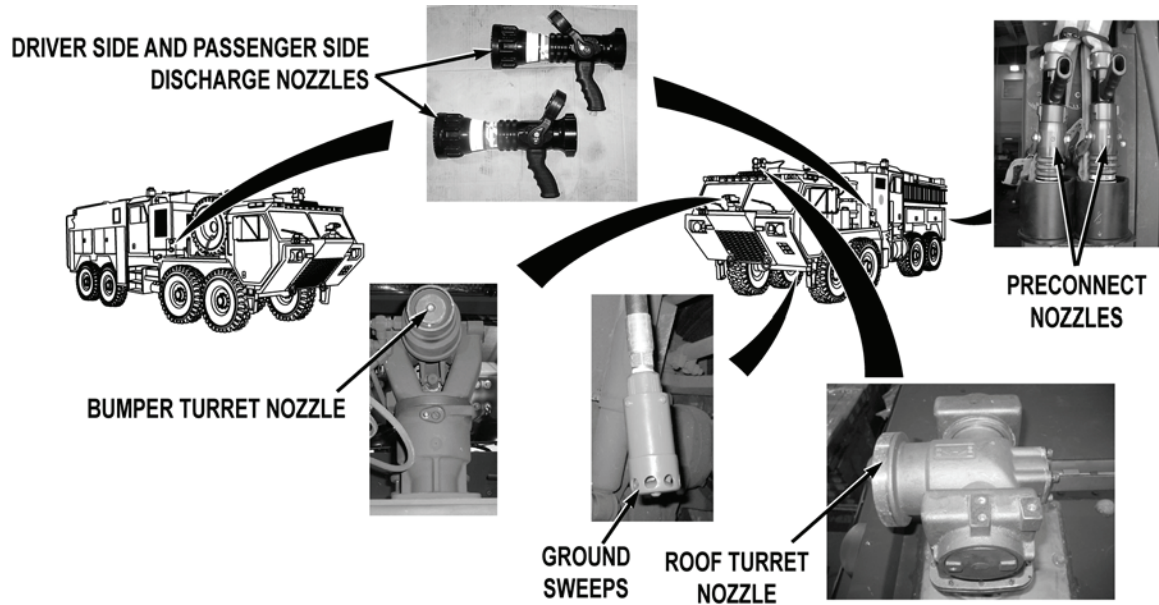
**MALFUNCTION****TEST OR INSPECTION****CORRECTIVE ACTION****WARNING**

**Vehicle engine must be turned off and all water pressure relieved from system before performing the following procedures. Failure to comply may cause injury to personnel.**

Check if discharge nozzles are free from dirt, debris, and obstructions.

- a. If discharge nozzles are not free from dirt, debris, and obstructions, clean obstructions from faulty discharge nozzle.
- b. If discharge nozzles are free from dirt, debris, and obstructions, notify Supervisor.

**END OF TASK**

**FOLLOW-ON MAINTENANCE**

Remove wheel chocks (TM 9-2320-347-10)

**END OF TASK**

**END OF WORK PACKAGE**

**FIELD LEVEL MAINTENANCE**

**CREW CAB AIR CONDITIONER/HEATER DOES NOT OPERATE PROPERLY**

**INITIAL SETUP:**

**Tools and Special Tools**

- Lead Set, Test (WP 0622, Item 21)
- Tool Kit, General Mechanic's: Automotive (WP 0622, Item 27)

**Personnel Required**

- MOS 63B Wheeled vehicle mechanic (2)

**References**

- TM 9-2320-325-14&P
- WP 0004
- WP 0007
- WP 0008
- WP 0009
- WP 0010
- WP 0072
- WP 0171
- WP 0197
- WP 0198
- WP 0199
- WP 0200
- WP 0201
- WP 0202
- WP 0203
- WP 0206
- WP 0207

**References (continued)**

- WP 0208
- WP 0209
- WP 0210
- WP 0311
- WP 0361
- WP 0373
- WP 0398
- WP 0433
- WP 0434
- WP 0436
- WP 0441
- WP 0446
- WP 0455
- WP 0501
- WP 0550

**Equipment Conditions**

- Water pump engine OFF (WP 0022)
- Engine OFF (TM 9-2320-347-10)
- Wheels chocked (TM 9-2320-347-10)

**MALFUNCTION**

**TEST OR INSPECTION**

**CORRECTIVE ACTION**

**CREW CAB AIR CONDITIONER/HEATER DOES NOT OPERATE PROPERLY**

---

**MALFUNCTION****TEST OR INSPECTION****CORRECTIVE ACTION**

---

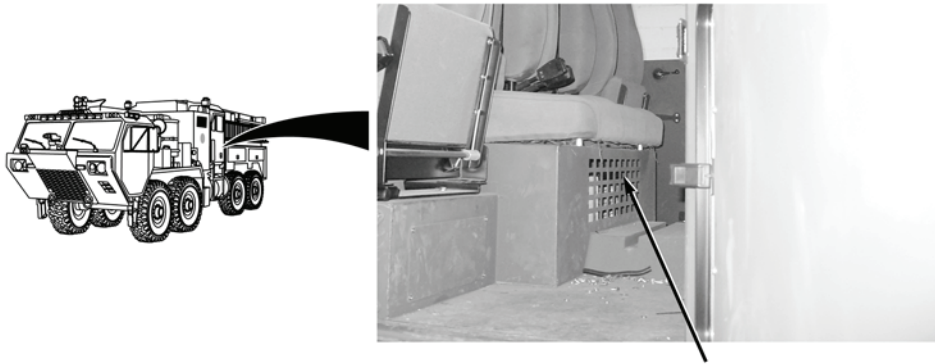

**CREW CAB  
AIR CONDITIONER/HEATER**

- Step 1. Turn battery disconnect switch to ON position (WP 0007). Put crew cab air conditioner/heater control panel to on position (WP 0008). Check if crew cab air conditioner/heater control panel display illuminates (WP 0004).

If crew cab air conditioner/heater control panel display does not illuminate, go to Step 45.

- Step 2. While operating crew cab air conditioner/heater, check if crew cab air conditioner/heater blower motor operates.

If crew cab air conditioner/heater blower motor does not operate, go to Step 38.



---

**MALFUNCTION****TEST OR INSPECTION****CORRECTIVE ACTION**

---

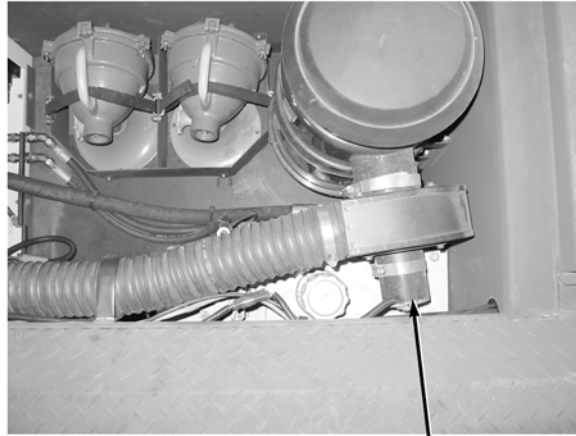
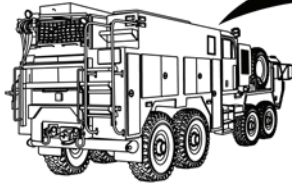

**CREW CAB  
AIR CONDITIONER/HEATER  
FRESH AIR FAN**

Step 3. While operating crew cab air conditioner/heater (WP 0008), check if crew cab air conditioner/heater fresh air fan operates.

If crew cab air conditioner/heater fresh air fan does not operate, go to Step 35.

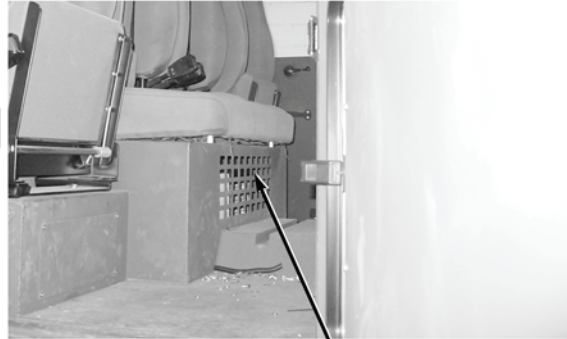
**MALFUNCTION****TEST OR INSPECTION****CORRECTIVE ACTION**

**CREW CAB  
AIR CONDITIONER/HEATER**

- Step 4. Start vehicle engine (TM 9-2320-347-10). Run vehicle engine till engine reaches operating temperature. Change crew cab air conditioner/heater control panel set point to 80°F (26°C) (WP 0009), check if crew cab air conditioner/heater produces warm air.

If crew cab air conditioner/heater does not produce warm air, go to Step 29.

- Step 5. Start crew cab air conditioner/heater (WP 0008). Change crew cab air conditioner/heater control panel set point to 45°F (7°C) (WP 0009), check if crew cab air conditioner/heater operates.

If crew cab air conditioner/heater does not operate, go to Step 7.

**NOTE**

TDH 02 and TLK 38 model crew cab air conditioner/heater control panels are programmed similarly. Crew cab air conditioner/heater control panel is preset to 68°F (20°C), it automatically resets to preset temperature when battery disconnect switch is turned OFF then to ON position.

- Step 6. Stop crew cab air conditioner (WP 0008). Shut vehicle engine off (TM 9-2320-347-10). Turn battery disconnect switch to OFF position (WP 0007). Turn battery disconnect switch to ON position (WP 0007). Press the P button on crew cab air conditioner/heater control panel (WP 0009), check if crew cab air conditioner/heater control panel set point is at 68°F (20°C).
- a. If crew cab air conditioner/heater control panel is programmed correctly, replace crew cab air conditioner/heater control panel (WP 0202).
  - b. If crew cab air conditioner/heater control panel is not programmed correctly, reprogram crew cab air conditioner/heater control panel (WP 0009).

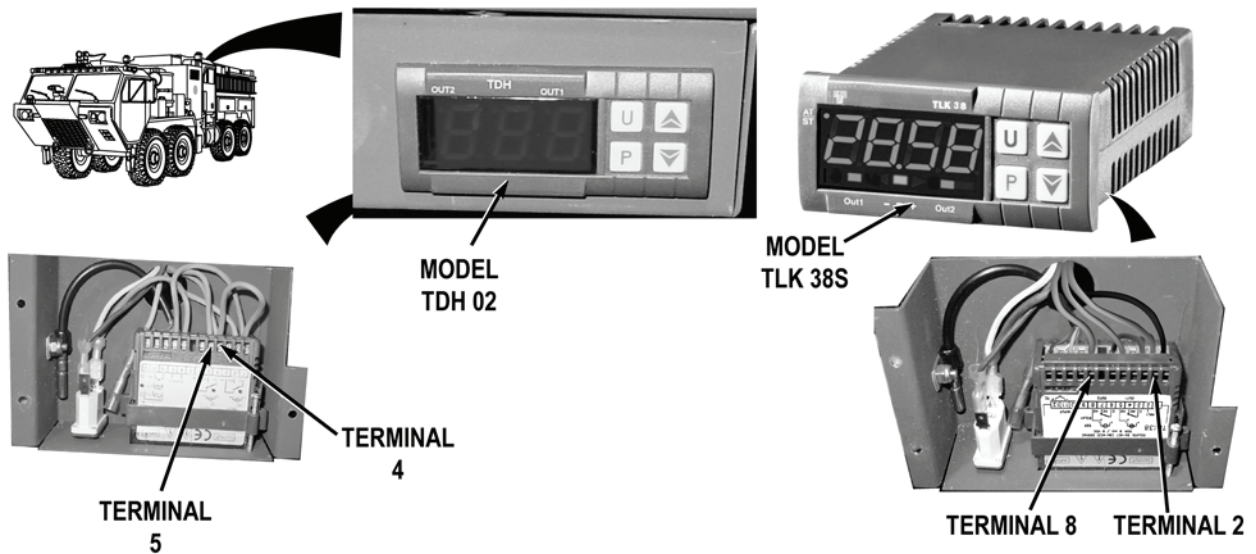
**MALFUNCTION****TEST OR INSPECTION****CORRECTIVE ACTION****WARNING**

Remove rings, wristwatches, neck chains, and any other jewelry before working around vehicle. Jewelry can catch on equipment and cause serious injury. Jewelry and tools may short across electrical circuits and cause damage to equipment, or severe burns or electrical shock to personnel.

**NOTE**

Determine which crew cab air conditioner/heater control panel is installed on vehicle for this Step. If model TDH 02 is installed on vehicle, install a jumperwire into terminals 4 and 5. If model TLK 38S is installed on vehicle, install a jumperwire into terminals 2 and 8.

- Step 7. Stop crew cab air conditioner (WP 0008). Shut vehicle engine off (TM 9-2320-347-10). Remove crew cab air conditioner/heater control panel (WP 0202). Install jumperwire into crew cab air conditioner/heater control panel terminals. Turn battery disconnect switch to ON position (WP 0007). Start crew cab air conditioner (WP 0008). Check if crew cab air conditioner compressor motor operates.

If crew cab air conditioner compressor motor does not operate, go to Step 22.

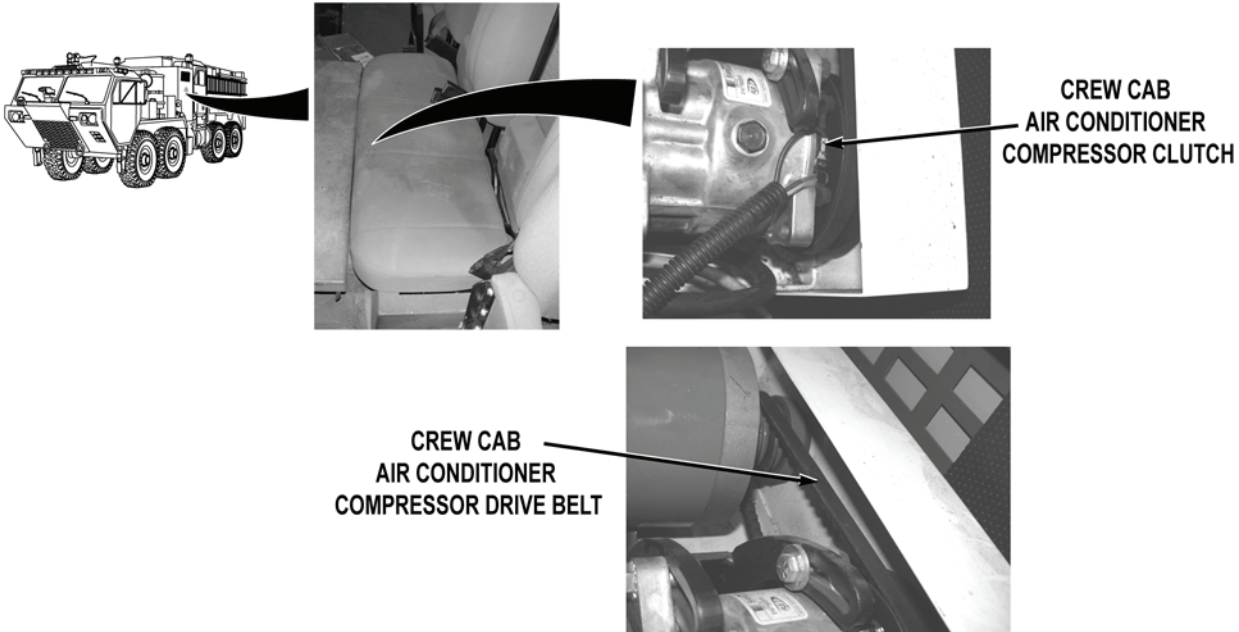
**MALFUNCTION****TEST OR INSPECTION****CORRECTIVE ACTION****WARNING**

**Moving compressor components can cause severe injury. Keep away from compressor belts and pulleys while compressor motor is running. Failure to comply may cause serious injury to personnel.**

- Step 8. While operating crew cab air conditioner, check if crew cab air conditioner compressor clutch engages.

If crew cab air conditioner compressor clutch does not engage, go to Step 15.

- Step 9. Stop crew cab air conditioner (WP 0008). Shut vehicle engine off (TM 9-2320-347-10). Turn battery disconnect switch to OFF position (WP 0007). Check if crew cab air conditioner compressor drive belt is tight and free from damage.

If crew cab air conditioner compressor drive belt is not tight or free from damage, tighten or replace crew cab compressor drive belt (WP 0198).

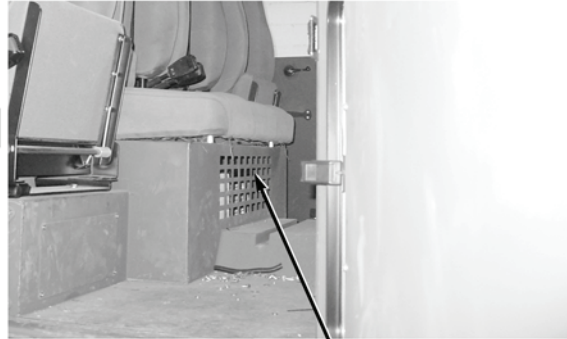
**MALFUNCTION****TEST OR INSPECTION****CORRECTIVE ACTION**

**CREW CAB  
AIR CONDITIONER/HEATER**

- Step 10. Start crew cab air conditioner (WP 0008). Check if crew cab air conditioner/heater produces cool air.

If crew cab air conditioner/heater does not produce cool air, troubleshoot Crew Cab Air Conditioner Does Not Cool or Cools Inadequately (WP 0072).

**CREW CAB AIR CONDITIONER  
CONDENSER FANS**

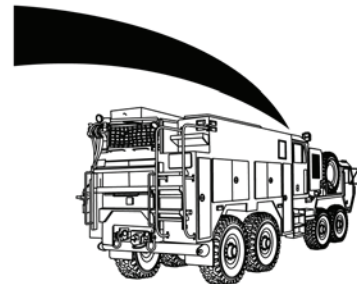
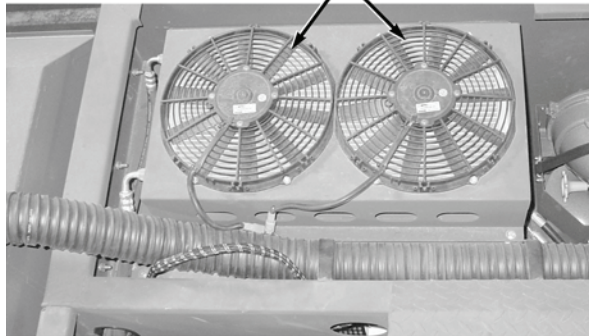

- Step 11. While operating crew cab air conditioner, check if both crew cab air conditioner condenser fans operate.

If one crew cab air conditioner condenser fan operates, go to Step 13.

## MALFUNCTION

## TEST OR INSPECTION

## CORRECTIVE ACTION

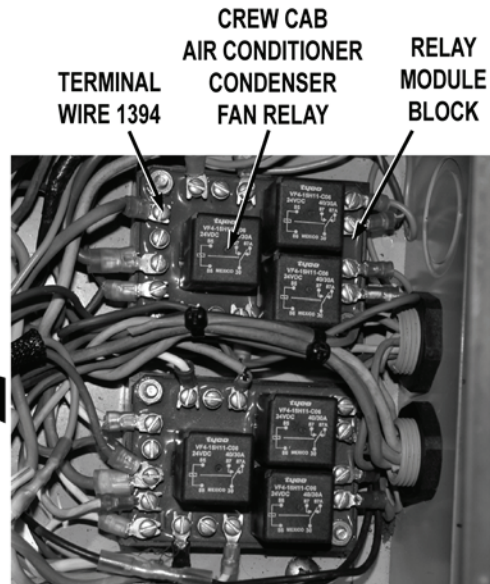
**WARNING**

Remove rings, wristwatches, neck chains, and any other jewelry before working around vehicle. Jewelry can catch on equipment and cause serious injury. Jewelry and tools may short across electrical circuits and cause damage to equipment, or severe burns or electrical shock to personnel.

- Step 12. Stop crew cab air conditioner (WP 0008). Shut vehicle engine off (TM 9-2320-347-10). Turn battery disconnect switch to OFF position (WP 0007). Remove crew cab air conditioner/heater control box cover (WP 0201). Start crew cab air conditioner (WP 0008). With a test lead set, check for 22 to 28 VDC at wire 1394 from relay module block crew cab air conditioner condenser fan relay, wire 1394 terminal to a known good ground.
- a. If 22 to 28 VDC are present, repair wire 1394 in body condenser wire harness if repairable (TM 9-2320-325-14&P), or replace body condenser wire harness (WP 0436).
  - b. If 22 to 28 VDC are not present, replace crew cab air conditioner/heater control box (WP 0201).

---

**MALFUNCTION**  
**TEST OR INSPECTION**  
**CORRECTIVE ACTION**

---

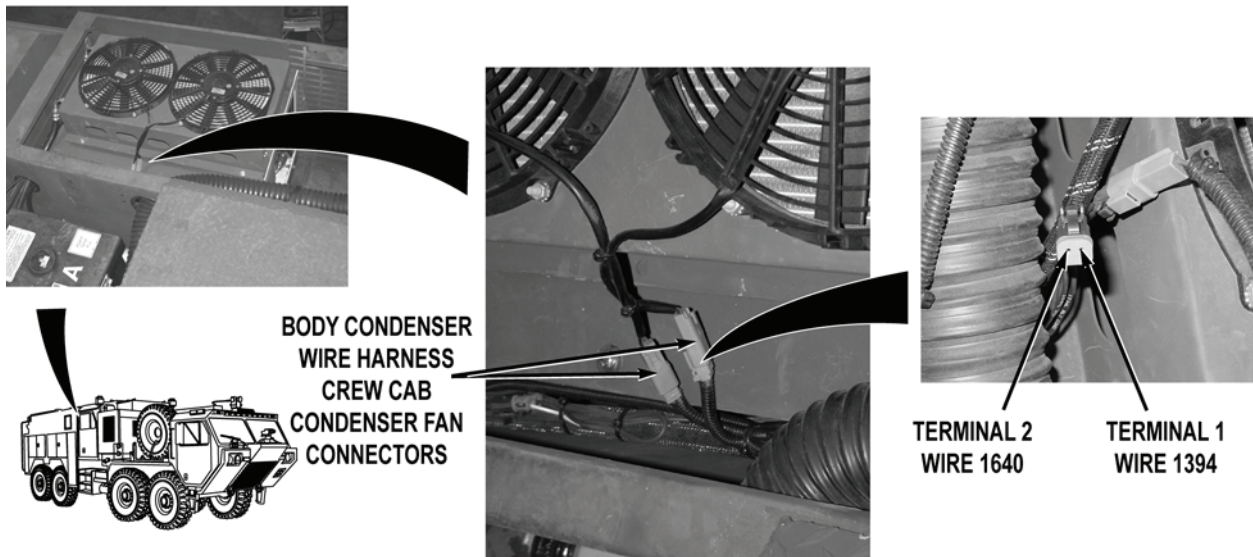

- Step 13. Stop crew cab air conditioner (WP 0008). Shut vehicle engine off (TM 9-2320-347-10). Turn battery disconnect switch to OFF position (WP 0007). Disconnect non-operating body condenser wire harness condenser fan connector. While an assistant starts crew cab air conditioner (WP 0008). With a test lead set, check for 22 to 28 VDC at wire 1394 from non-operating body condenser wire harness crew cab condenser fan connector, terminal 1 to a known good ground.

If 22 to 28 VDC are not present, repair wire 1394 in body condenser wire harness if repairable (TM 9-2320-325-14&P), or replace body condenser wire harness (WP 0436).

- Step 14. Stop crew cab air conditioner (WP 0008). Shut vehicle engine off (TM 9-2320-347-10). Turn battery disconnect switch to OFF position (WP 0007). With a test lead set, check for continuity across wire 1640 from non-operating body condenser wire harness crew cab condenser fan connector, terminal 2 to a known good ground.
- a. If continuity is present, replace non-operating air conditioner condenser fan (WP 0199).
  - b. If there is no continuity, repair wire 1640 in body condenser wire harness if repairable (TM 9-2320-325-14&P), or replace body air condenser wire harness (WP 0436).

## MALFUNCTION

## TEST OR INSPECTION

## CORRECTIVE ACTION

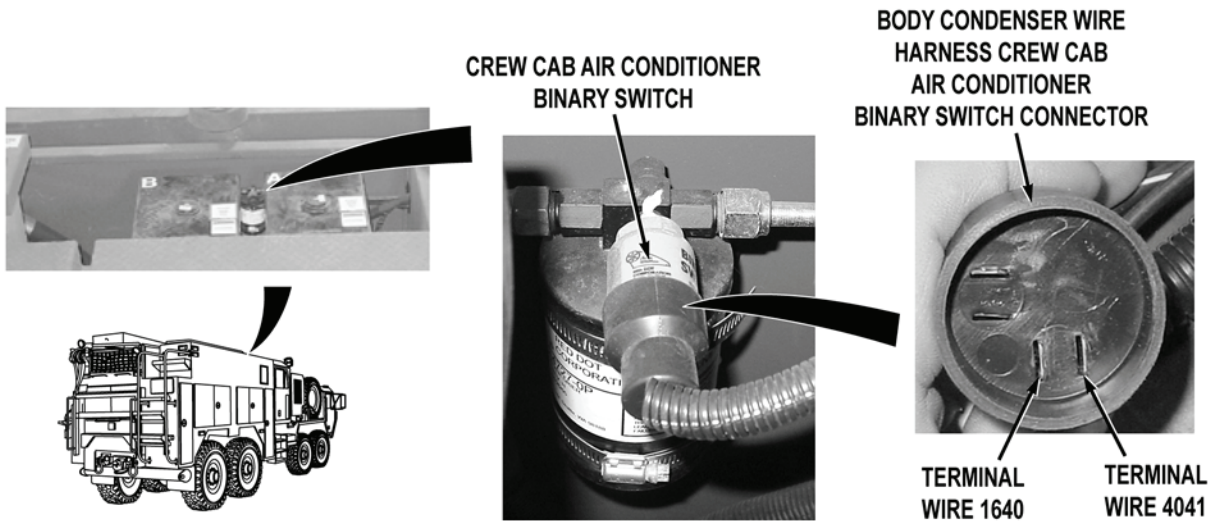
**WARNING**

**Remove rings, wristwatches, neck chains, and any other jewelry before working around vehicle. Jewelry can catch on equipment and cause serious injury. Jewelry and tools may short across electrical circuits and cause damage to equipment, or severe burns or electrical shock to personnel.**

- Step 15. Stop crew cab air conditioner (WP 0008). Stop vehicle engine (TM 9-2320-347-10). Turn battery disconnect switch to OFF position (WP 0007). Disconnect body condenser wire harness crew cab air conditioner binary switch connector from crew cab air conditioner binary switch. Start crew cab air conditioner (WP 0008). While an assistant, puts crew cab air conditioner/heater control panel setting to 45°F (7°C) (WP 0009), with a test lead set, check for 22 to 28 VDC at wire 4041 from body condenser wire harness crew cab air conditioner binary switch connector to a known good ground.

If 22 to 28 VDC are not present, go to Step 17.



**MALFUNCTION****TEST OR INSPECTION****CORRECTIVE ACTION**

- Step 16. Stop crew cab air conditioner (WP 0008). Shut vehicle engine off (TM 9-2320-347-10). Turn battery disconnect switch to OFF position (WP 0007). With a test lead set, check for continuity across wire 1640 from body condenser wire harness crew cab air conditioner binary switch connector to a known good ground.
- If continuity is present, replace crew cab air conditioner binary switch (WP 0197).
  - If continuity is not present, repair wire 1640 in body air condenser wire harness if repairable (TM 9-2320-325-14&P), or replace body air condenser wire harness (WP 0436).

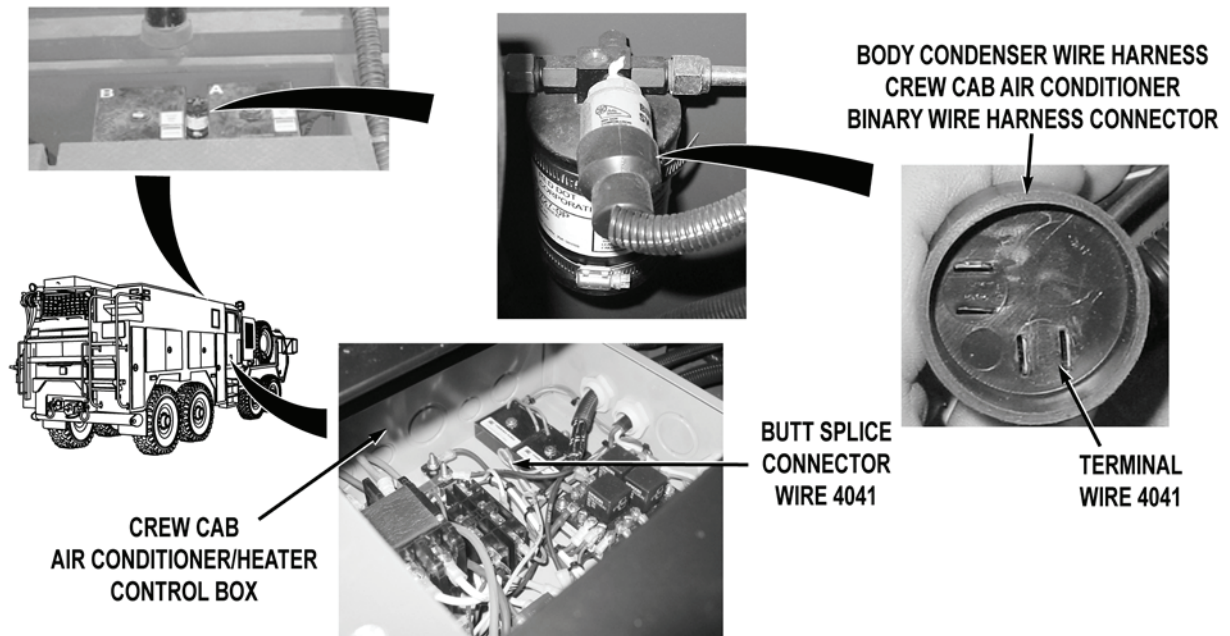

- Step 17. Stop crew cab air conditioner (WP 0008). Shut vehicle engine off (TM 9-2320-347-10). Turn battery disconnect switch to OFF position (WP 0007). Remove crew cab air conditioner/heater control box cover (WP 0201). Cut wire 4041 at butt splice connector in crew cab air conditioner/heater control box. With a test lead set check for continuity across wire 4041 from body condenser wire harness crew cab air conditioner binary switch connector terminal, to butt splice termination in crew cab air conditioner/heater control box.

If continuity is not present, repair wire 4041 in body air condenser wire harness if repairable (TM 9-2320-325-14&P), or replace body air condenser wire harness (WP 0436).

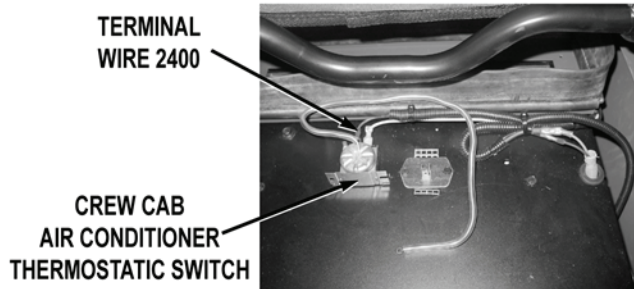
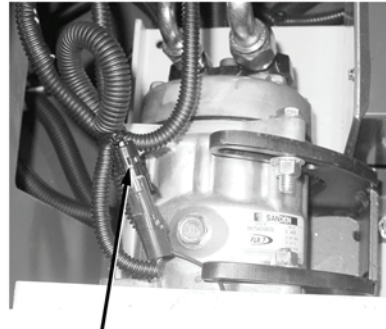
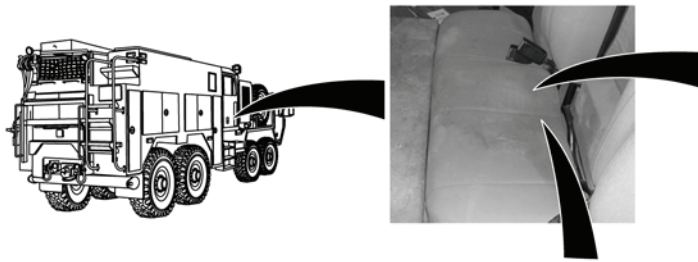
**MALFUNCTION****TEST OR INSPECTION****CORRECTIVE ACTION**

**BODY CONDENSER  
WIRE HARNESS CREW CAB  
AIR CONDITIONER  
COMPRESSOR CLUTCH  
CONNECTOR**

**TERMINAL  
WIRE 2400**

**CREW CAB  
AIR CONDITIONER  
THERMOSTATIC SWITCH**

**WARNING**

**Remove rings, wristwatches, neck chains, and any other jewelry before working around vehicle. Jewelry can catch on equipment and cause serious injury. Jewelry and tools may short across electrical circuits and cause damage to equipment, or severe burns or electrical shock to personnel.**

- Step 18. Repair wire 4041 at butt splice (TM 9-2320-325-14&P). Remove crew cab bench seat and access panel (WP 0501). Disconnect body air condenser wire harness crew cab air conditioner compressor clutch connector. Start crew cab air conditioner (WP 0008). Put crew cab air conditioner/heater control panel setting to 45°F (7°C) (WP 0009). With a test lead set, check for 22 to 28 VDC from body air condenser wire harness crew cab air conditioner compressor clutch connector to a known good ground.

If 22 to 28 VDC are present, replace crew cab air conditioner compressor (WP 0210).

- Step 19. Stop crew cab air conditioner (WP 0008). Shut vehicle engine off (TM 9-2320-347-10). Turn battery disconnect switch to OFF position (WP 0007). Disconnect crew cab air conditioner thermostatic switch wire 2400 (red) at terminal. Check for continuity across wire 2400 (red) from crew cab air conditioner thermostatic switch to body air condenser wire harness crew cab air conditioner compressor clutch connector.

If continuity is not present, repair wire 2400 in body air condenser wire harness if repairable (TM 9-2320-325-14&P), or replace body air condenser wire harness (WP 0436).

---

**MALFUNCTION**  
**TEST OR INSPECTION**  
**CORRECTIVE ACTION**

---

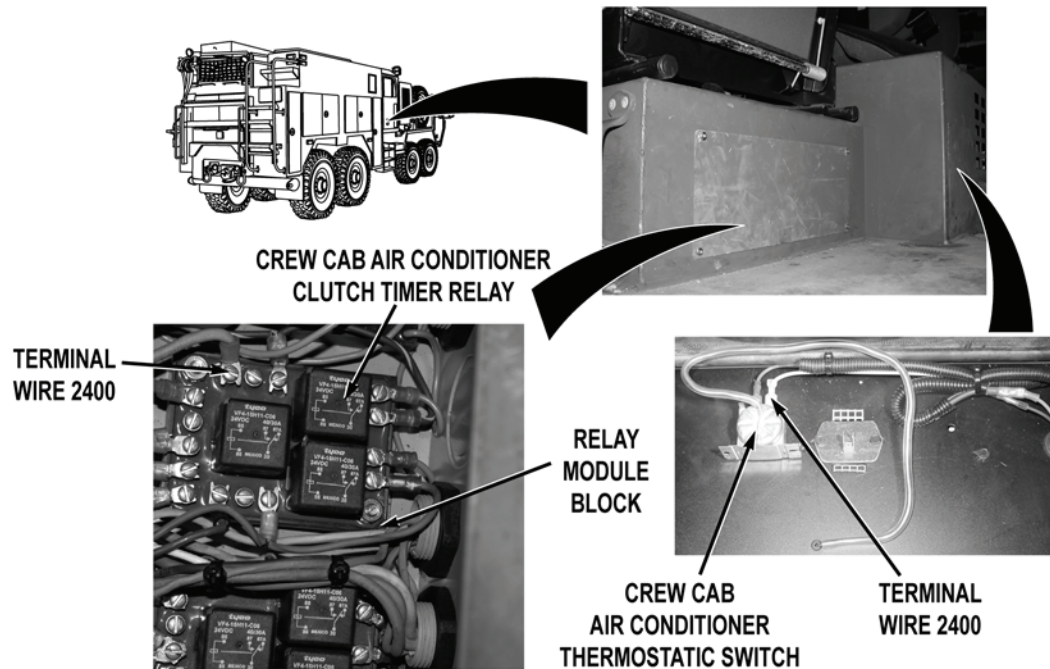

- Step 20. Disconnect crew cab air conditioner thermostatic switch wire 2400 (white) at terminal. Start crew cab air conditioner (WP 0008). Put crew cab air conditioner/heater control panel setting to 45°F (7°C) (WP 0009). With a test lead set, check for 22 to 28 VDC from crew cab air conditioner thermostatic switch wire 2400 (white) terminal to a known good ground.
- If 22 to 28 VDC are present, replace crew cab air conditioner thermostatic switch (WP 0206).
- Step 21. Stop crew cab air conditioner (WP 0008). Shut vehicle engine off (TM 9-2320-347-10). Turn battery disconnect switch to OFF position (WP 0007). Check for continuity across wire 2400 (white) from crew cab air conditioner thermostatic switch to relay module block crew cab air conditioner clutch timer relay terminal.
- a. If there is continuity, replace crew cab air conditioner/heater control box (WP 0201).
  - b. If there is no continuity, repair wire 2400 in body air condenser wire harness if repairable (TM 9-2320-325-14&P) or replace body air condenser wire harness (WP 0436).
- Step 22. Open passenger side rear stowage compartment P1 (WP 0010). Check if hydraulic digital display illuminates (WP 0004).
- If hydraulic digital display does not illuminate, troubleshoot Hydraulic Generator Does Not Operate Properly (WP 0171).

**MALFUNCTION****TEST OR INSPECTION****CORRECTIVE ACTION**

**CREW CAB AIR CONDITIONER  
CONTROL CONTACTOR**

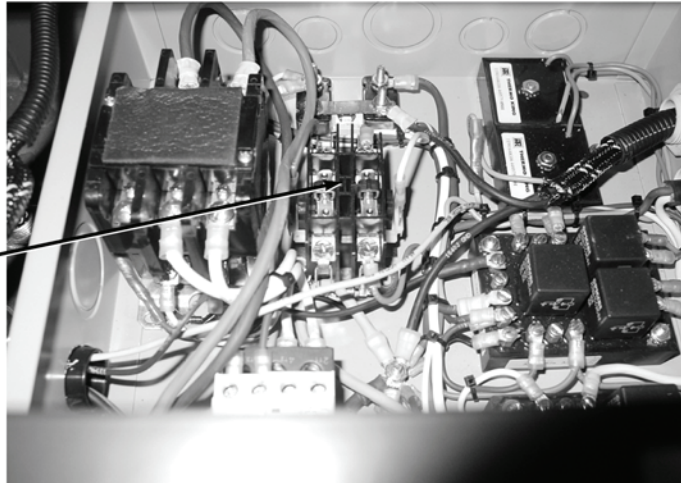
**WARNING**

**Remove rings, wristwatches, neck chains, and any other jewelry before working around vehicle. Jewelry can catch on equipment and cause serious injury. Jewelry and tools may short across electrical circuits and cause damage to equipment, or severe burns or electrical shock to personnel.**

**NOTE**

Crew cab air conditioner control contactor operation can be checked, by observing the movement of the contactor when circuit breakers 12 and 14 are put to ON position.

- Step 23. Stop crew cab air conditioner (WP 0008). Shut vehicle engine off (TM 9-2320-347-10). Turn battery disconnect switch to OFF position (WP 0007). Remove crew cab air conditioner/heater control box cover (WP 0201). Start crew cab air conditioner (WP 0008). While an assistant puts circuit breakers 12 and 14 to ON and OFF positions (WP 0008), check if crew cab air conditioner control contactor operates.

If crew cab air conditioner control contactor operates, go to Step 26.

MALFUNCTION	TEST OR INSPECTION	CORRECTIVE ACTION
-------------	--------------------	-------------------

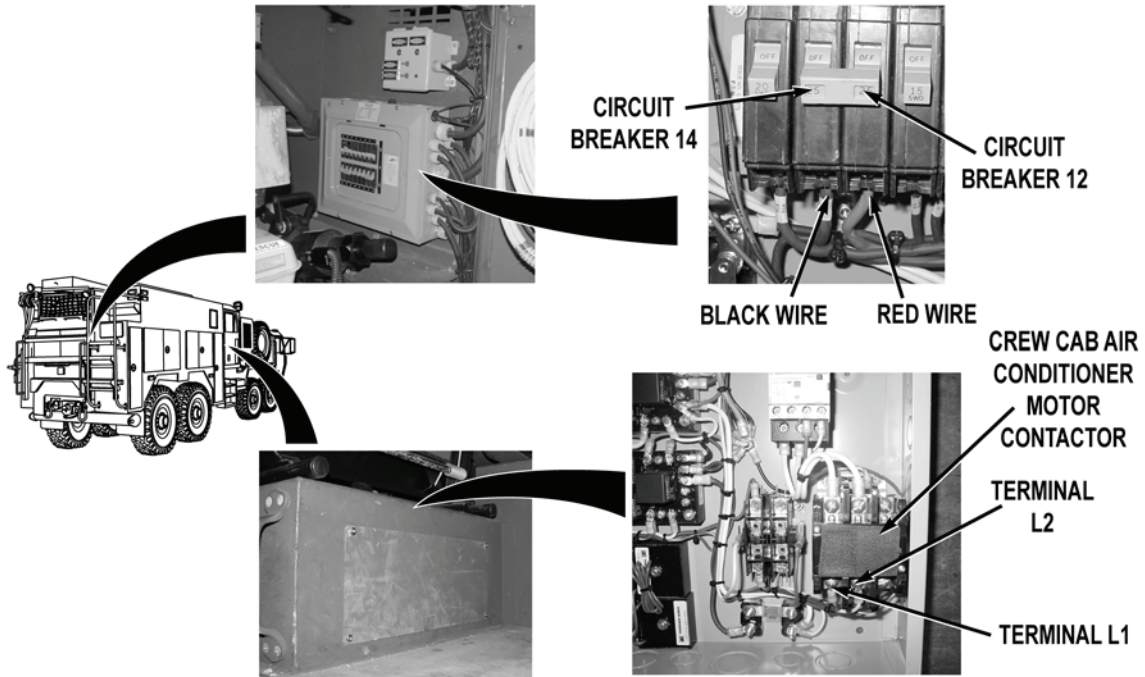

Step 24. Stop crew cab air conditioner (WP 0008). Shut vehicle engine off (TM 9-2320-347-10). Turn battery disconnect switch to OFF position (WP 0007). Remove circuit breaker box cover (WP 0373). Remove red wire from circuit breaker 12, install a jumperwire between red wire and a known good ground. Check for continuity across red wire from crew cab air conditioner motor contactor, terminal L1 to a known good ground.

If continuity is not present, replace 120-volt power cord (WP 0361).

Step 25. Remove black wire from circuit breaker 14, install a jumperwire between black wire and a known good ground. Check for continuity across black wire from crew cab air conditioner motor contactor, terminal L2 to a known good ground.

- a. If continuity is present, replace crew cab air conditioner/heater control box (WP 0201).
- b. If continuity is not present, replace 120-volt power cord (WP 0361).

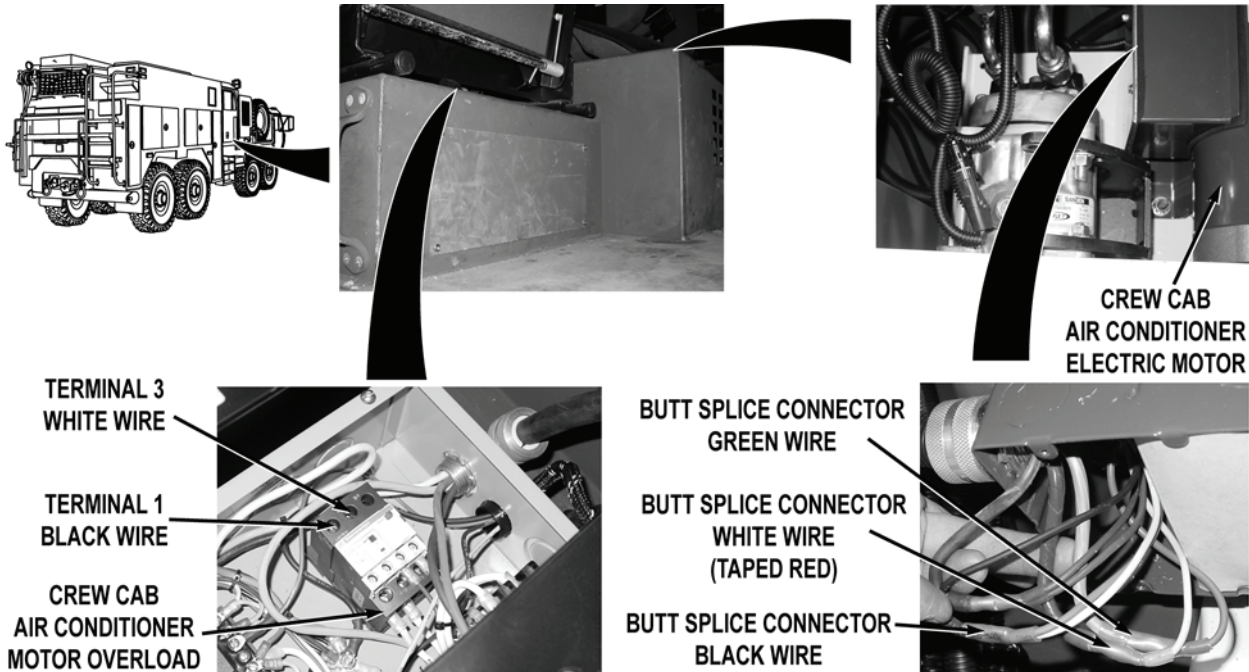
**MALFUNCTION****TEST OR INSPECTION****CORRECTIVE ACTION**

- Step 26. Stop crew cab air conditioner (WP 0008). Shut vehicle engine off (TM 9-2320-347-10). Turn battery disconnect switch to OFF position (WP 0007). Remove crew cab bench seat and access panel (WP 0501). Remove cover from crew cab air conditioner electric motor (WP 0210). Cut black wire at butt splice connector. Check for continuity across black wire from crew cab air conditioner control box motor overload terminal 1, to black wire termination at crew cab air conditioner electric motor.

If continuity is not present, replace air conditioner electric motor wire harness (WP 0434).

- Step 27. Cut green wire at butt splice connector at crew cab air conditioner electric motor. Check for continuity across green wire from green wire termination at crew cab air conditioner electric motor to a known good ground.

If continuity is not present, replace air conditioner electric motor wire harness (WP 0434).

- Step 28. Cut white wire at butt splice connector at crew cab air conditioner electric motor. Check for continuity across white wire from crew cab air conditioner control box motor overload terminal 3, to white wire termination at crew cab air conditioner electric motor.

- a. If continuity is present, replace crew cab air conditioner motor (WP 0210).
- b. If continuity is not present, replace air conditioner electric motor wire harness (WP 0434).

---

**MALFUNCTION****TEST OR INSPECTION****CORRECTIVE ACTION**

---

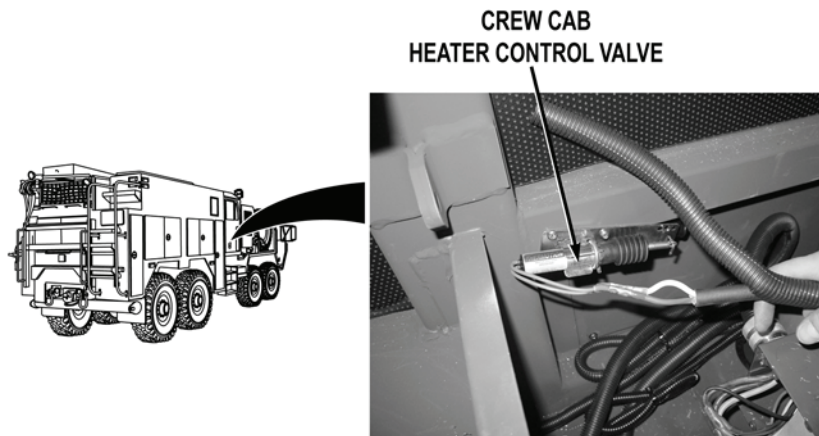

- Step 29. Remove crew cab bench seat and access panel (WP 0501). While an assistant changes air conditioner/heater control panel programmed temperature below and above set point temperature (WP 0009), check if crew cab heater control valve operates.

If crew cab heater control valve does not operate, go to Step 32.

**MALFUNCTION**

**TEST OR INSPECTION**

**CORRECTIVE ACTION**

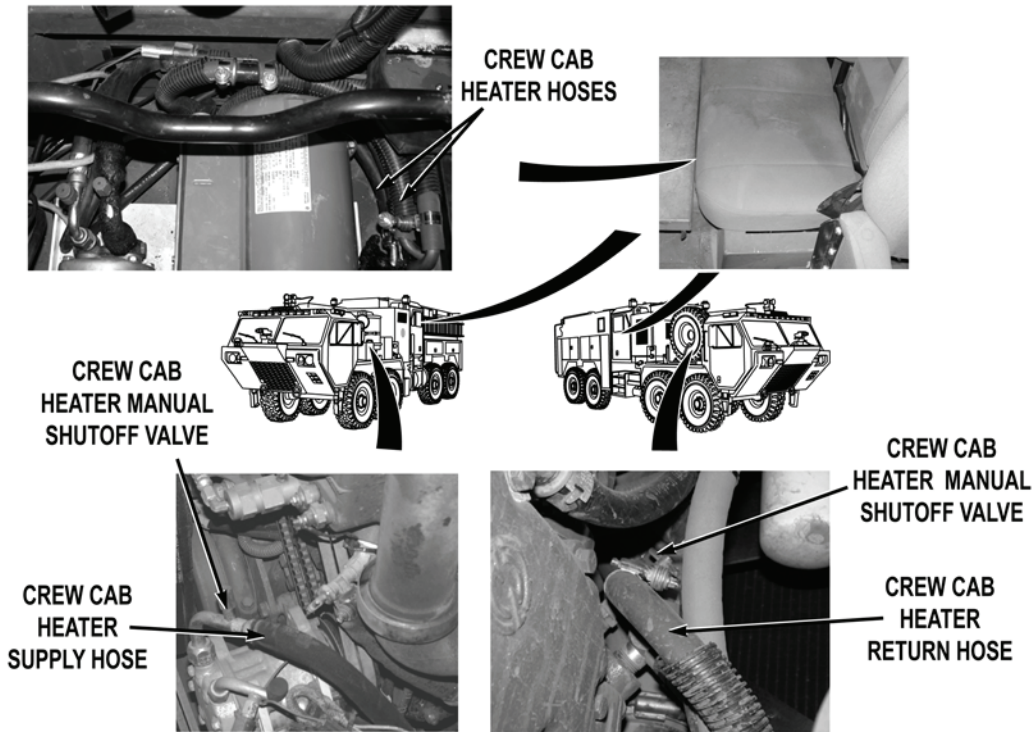

**WARNING**



**Allow engine to completely cool before handling any cooling system component or hose. Failure to comply can result in serious injury to personnel.**

- Step 30. Shut vehicle engine off (TM 9-2320-347-10). Turn battery disconnect switch to OFF position (WP 0007). Remove vehicle engine panels (TM 9-2320-347-10). Check if crew cab heater manual shutoff valves are in open position.

If crew cab heater manual shutoff valves are not open, open heater manual shutoff valves.

- Step 31. Check if crew cab heater supply and return hoses are free from leaks, kinks, and damage.
  - a. If crew cab heater supply and return hoses are free from leaks, kinks, and damage, replace crew cab heater core (WP 0208).
  - b. If crew cab heater supply and return hoses are not free from leaks, kinks, and damage, replace damaged hoses (WP 0209).

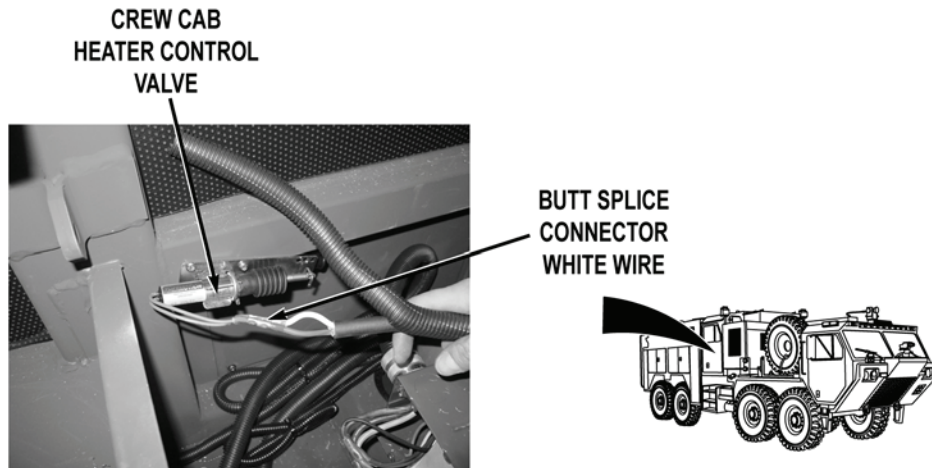

**MALFUNCTION****TEST OR INSPECTION****CORRECTIVE ACTION****WARNING**

**Remove rings, wristwatches, neck chains, and any other jewelry before working around vehicle. Jewelry can catch on equipment and cause serious injury. Jewelry and tools may short across electrical circuits and cause damage to equipment, or severe burns or electrical shock to personnel.**

- Step 32. Shut vehicle engine off (TM 9-2320-347-10). Turn battery disconnect switch to OFF position (WP 0007). Cut white wire at crew cab heater control valve butt splice connector. Turn battery disconnect switch to ON position (WP 0007). Put crew cab air conditioner/heater control panel switch to on position (WP 0008). While an assistant puts crew cab air conditioner/heater control panel set point to 80°F (26°C) (WP 0009), check for 22 to 28 VDC at crew cab heater control valve white wire butt splice connector termination to a known good ground.

If 22 to 28 VDC are not present, go to Step 34.

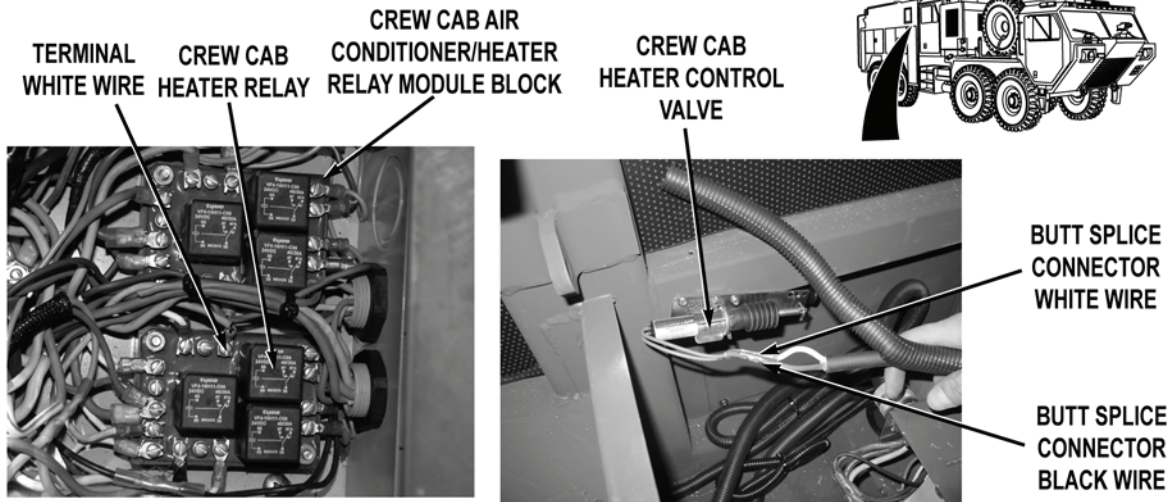
**MALFUNCTION****TEST OR INSPECTION****CORRECTIVE ACTION**

- Step 33. Put crew cab air conditioner/ heater control panel switch to off position (WP 0008). Turn battery disconnect switch to OFF position (WP 0007). Repair white wire at crew cab heater control valve butt connector TM 9-2320-325-14&P. Cut black wire at crew cab heater control valve butt connector. Check for continuity across black wire from crew cab heater control valve butt splice connector termination to a known good ground.
- a. If continuity is present, replace crew cab heater control valve (WP 0207).
  - b. If continuity is not present, repair or replace black wire (TM 9-2320-325-14&P).
- Step 34. Put crew cab air conditioner/ heater control panel switch to off position (WP 0008). Turn battery disconnect switch to OFF position (WP 0007). Check for continuity across white wire from crew cab heater control valve butt splice connector termination to crew cab air conditioner/heater control box relay module block crew cab heater relay white wire terminal.
- a. If continuity is present, replace crew cab air conditioner/heater control box (WP 0201).
  - b. If continuity is not present, replace white wire (TM 9-2320-325-14&P).

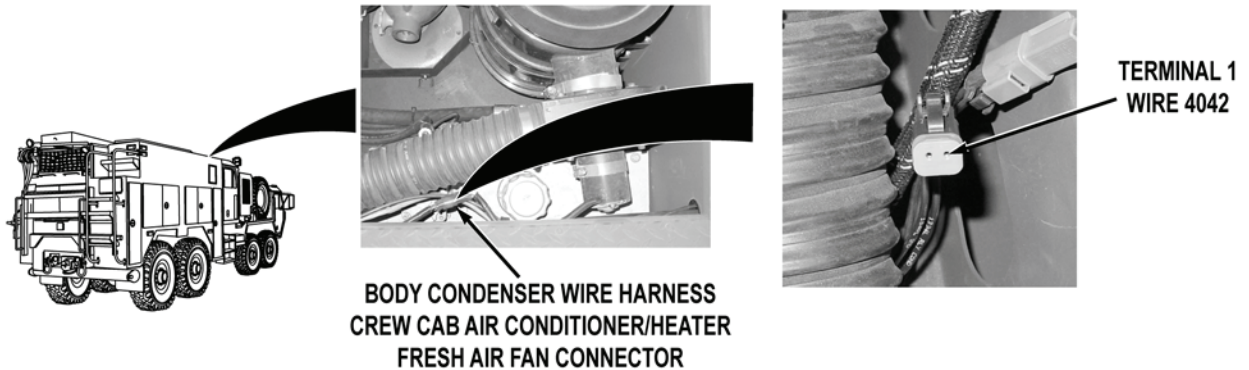
**MALFUNCTION****TEST OR INSPECTION****CORRECTIVE ACTION****WARNING**

**Remove rings, wristwatches, neck chains, and any other jewelry before working around vehicle. Jewelry can catch on equipment and cause serious injury. Jewelry and tools may short across electrical circuits and cause damage to equipment, or severe burns or electrical shock to personnel.**

- Step 35. Stop crew cab air conditioner (WP 0008). Shut vehicle engine off (TM 9-2320-347-10). Turn battery disconnect switch to OFF position (WP 0007). Disconnect body condenser wire harness crew cab air conditioner fresh air fan connector. Turn battery disconnect switch to ON position (WP 0007). Put crew cab air conditioner/heater switch to on position (WP 0008). With a test lead set, check for 22 to 28 VDC at wire 4042 from body wire harness crew cab air conditioner/heater fresh air fan connector, terminal 1 to a known good ground.

If 22 to 28 VDC are not present, go to Step 37.

## MALFUNCTION

## TEST OR INSPECTION

## CORRECTIVE ACTION

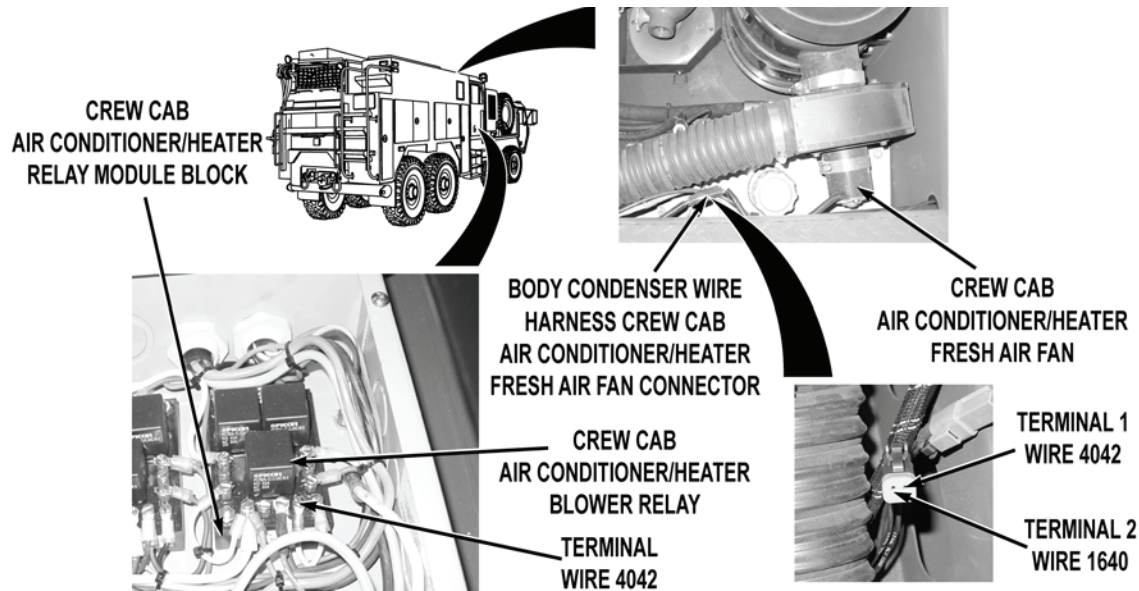

- Step 36. Put crew cab air conditioner/ heater control panel switch to off position (WP 0008). Turn battery disconnect switch to OFF position (WP 0007). With a test lead set, check for continuity across wire 1640 from body condenser wire harness crew cab air conditioner/ heater fresh air fan connector, terminal 2 to a known good ground.
- If continuity is present, replace crew cab air conditioner/heater fresh air fan (WP 0203).
  - If continuity is not present, repair wire 1640 in body condenser wire harness if repairable (TM 9-2320-325-14&P), or replace body air condenser wire harness (WP 0436).
- Step 37. Put crew cab air conditioner/ heater control panel switch to off position (WP 0008). Turn battery disconnect switch to OFF position (WP 0007). Remove crew cab air conditioner/heater control box cover (WP 0201). With a test lead set, check for continuity across wire 4042 from body condenser wire harness crew cab air conditioner/ heater fresh air fan connector, terminal 1 to crew cab air conditioner/heater relay module block, crew cab air conditioner heater blower relay.
- If continuity is present, replace crew cab air conditioner/heater control box (WP 0201).
  - If continuity is not present, repair wire 4042 in body condenser wire harness if repairable (TM 9-2320-325-14&P), or replace body air condenser wire harness (WP 0436).
- Step 38. While operating crew cab air conditioner/heater (WP 0008), check if crew cab air conditioner/heater fresh air fan operates.
- If crew cab air conditioner/heater fresh air fan does not operate, go to Step 42.

## MALFUNCTION

## TEST OR INSPECTION

## CORRECTIVE ACTION

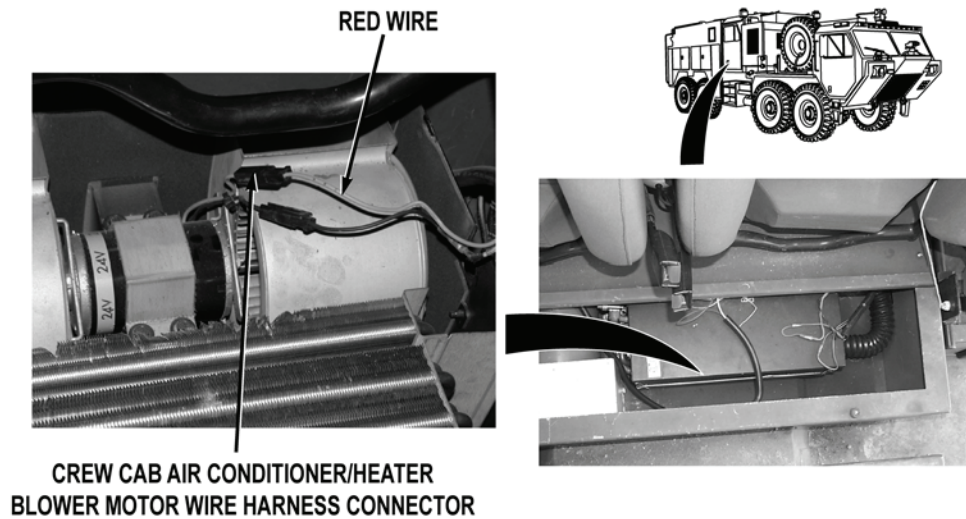
**WARNING**

**Remove rings, wristwatches, neck chains, and any other jewelry before working around vehicle. Jewelry can catch on equipment and cause serious injury. Jewelry and tools may short across electrical circuits and cause damage to equipment, or severe burns or electrical shock to personnel.**

- Step 39. Put crew cab air conditioner/ heater control panel switch to off position (WP 0008). Turn battery disconnect switch to OFF position (WP 0007). Remove crew cab air conditioner/heater assembly cover (WP 0200). Disconnect crew cab air conditioner/ heater blower motor red wire connector. Turn battery disconnect switch to ON position (WP 0007). Put crew cab air conditioner/heater control panel switch to on position (WP 0008). With a test lead set check for 22 to 28 VDC at red wire from crew cab air conditioner/heater blower motor wire harness connector to a known good ground.

If 22 to 28 VDC are not present, go to Step 41.

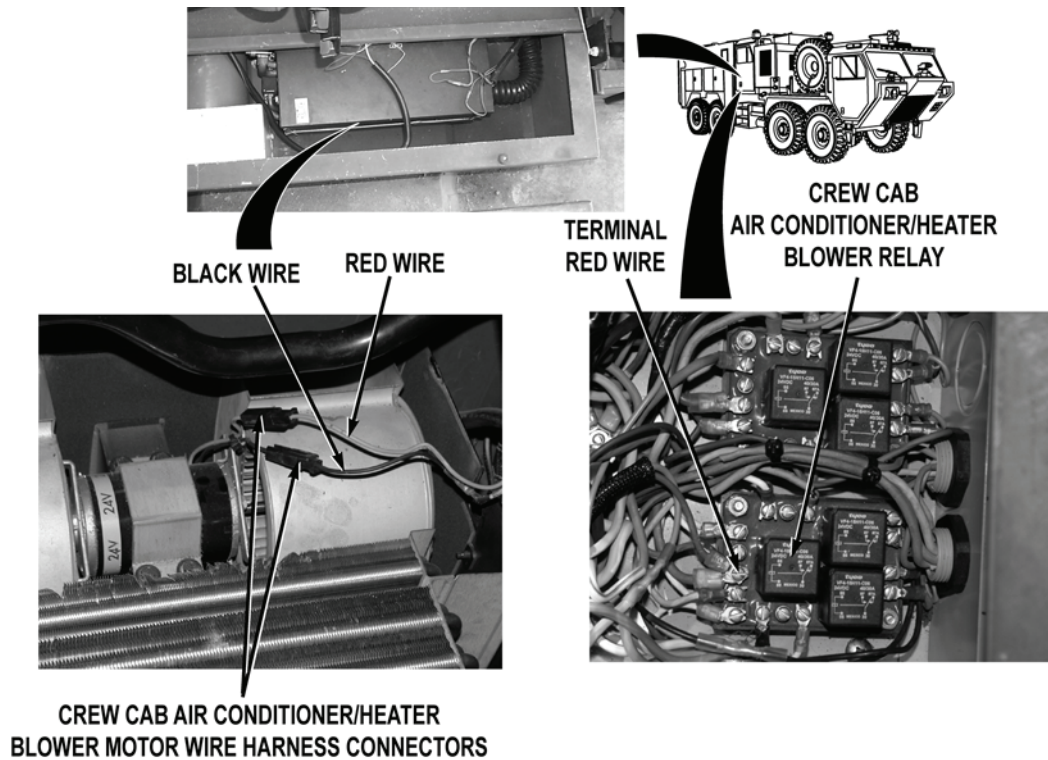
**MALFUNCTION****TEST OR INSPECTION****CORRECTIVE ACTION**

- Step 40. Put crew cab air conditioner/heater control panel switch to off position (WP 0008). Turn battery disconnect switch to OFF position (WP 0007). Reconnect crew cab air conditioner/heater blower motor red wire connector. Disconnect crew cab air conditioner/heater blower motor black wire connector. With a test lead set check for continuity across black wire from crew cab air conditioner/heater blower motor wire harness connector to a known good ground.
- a. If continuity is present, replace crew cab air conditioner/heater blower motor (WP 0200).
  - b. If continuity is not present, repair or replace black wire (TM 9-2320-325-14&P).
- Step 41. Put crew cab air conditioner/heater control panel to off position (WP 0008). Turn battery disconnect switch to OFF position (WP 0007). Remove crew cab air conditioner/heater control box cover (WP 0201). Check for continuity across red wire from crew cab air conditioner/heater blower motor wire harness connector to crew cab air conditioner/heater control box relay module block, crew cab air conditioner/heater blower relay red wire terminal.
- a. If continuity is present, replace crew cab air conditioner/heater control box (WP 0201).
  - b. If continuity is not present, repair or replace red wire (TM 9-2320-325-14&P).

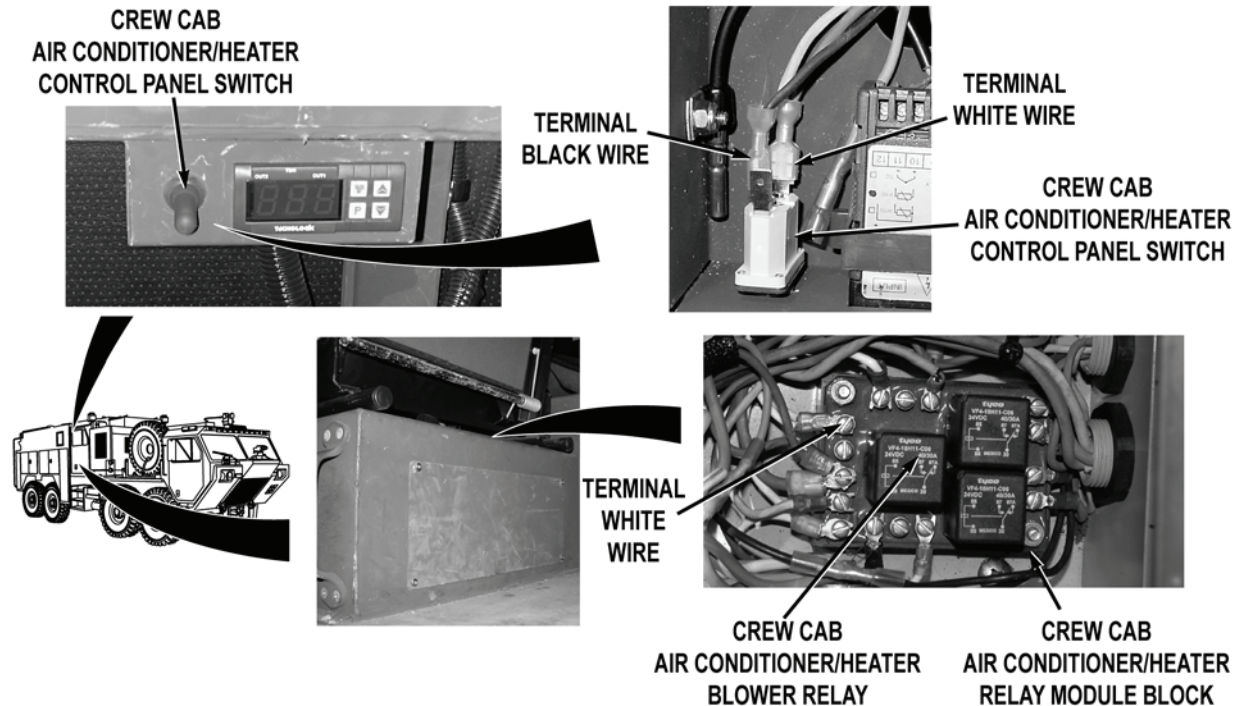
**MALFUNCTION****TEST OR INSPECTION****CORRECTIVE ACTION**

- Step 42. Put crew cab air conditioner/ heater control panel switch to off position (WP 0008). Turn battery disconnect switch to OFF position (WP 0007). Remove crew cab air conditioner/heater control panel (WP 0202). Turn battery disconnect switch to ON position (WP 0007). Check for 22 to 28 VDC at crew cab air conditioner/ heater relay module block, crew cab air conditioner/heater blower relay white wire terminal.

If 22 to 28 VDC are not present, replace air conditioner/heater control box (WP 0201).

- Step 43. Check for continuity across white wire terminal from crew cab air conditioner/ heater control panel switch white wire terminal to crew cab air conditioner/ heater relay module block, crew cab air conditioner/heater blower relay white wire terminal.

If continuity is not present, replace air conditioner controller wire harness (WP 0433).

- Step 44. Turn battery disconnect switch to OFF position (WP 0007). Check for continuity across black wire terminal from crew cab air conditioner/ heater control panel switch to a known good ground.
- a. If continuity is present, replace crew cab air conditioner/heater control panel switch (WP 0202).
  - b. If continuity is not present, replace air conditioner controller wire harness (WP 0433).

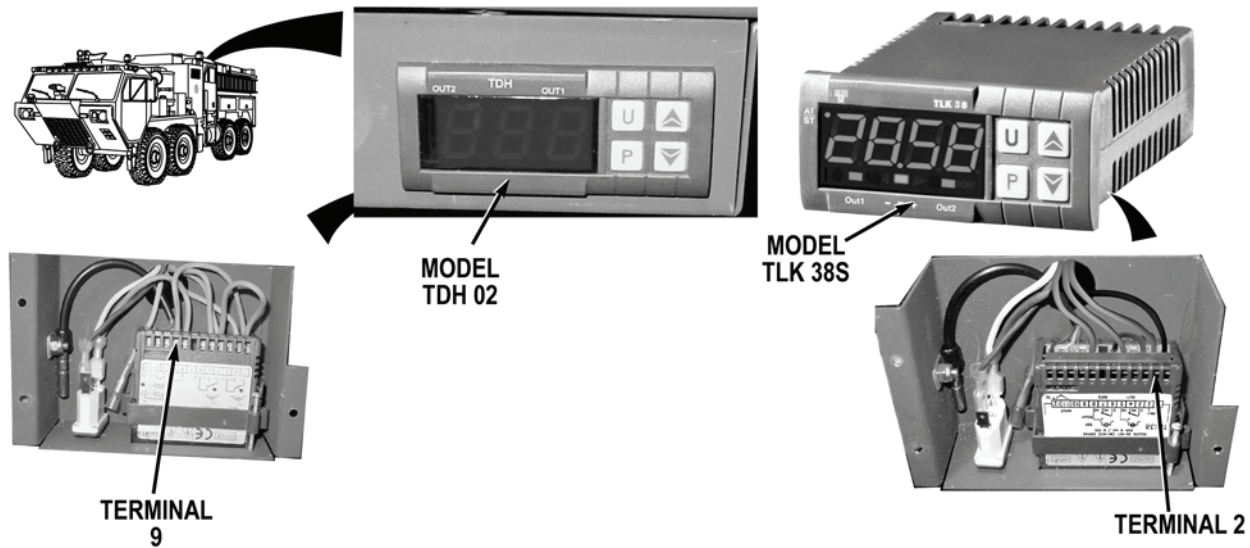
**MALFUNCTION****TEST OR INSPECTION****CORRECTIVE ACTION****WARNING**

Remove rings, wristwatches, neck chains, and any other jewelry before working around vehicle. Jewelry can catch on equipment and cause serious injury. Jewelry and tools may short across electrical circuits and cause damage to equipment, or severe burns or electrical shock to personnel.

**NOTE**

Determine which crew cab air conditioner/heater control panel is installed on vehicle for this Step. If model TDH 02 is installed on vehicle, check for voltage at terminals 1, 4, and 9. If model TLK 38S is installed on vehicle, check for voltage at terminals 2, 3, and 6.

- Step 45. Stop crew cab air conditioner (WP 0008). Shut vehicle engine off (TM 9-2320-347-10). Turn battery disconnect switch to OFF position (WP 0007). Remove crew cab air conditioner/heater control panel (WP 0202). Turn battery disconnect switch to ON position (WP 0007). Check for 22 to 28 VDC at crew cab air conditioner control panel, terminal 9 for model TDH 20 or terminal 2 for model TLK 38S.

If 22 to 28 VDC are present, go to Step 52.



**MALFUNCTION**

**TEST OR INSPECTION**

**CORRECTIVE ACTION**

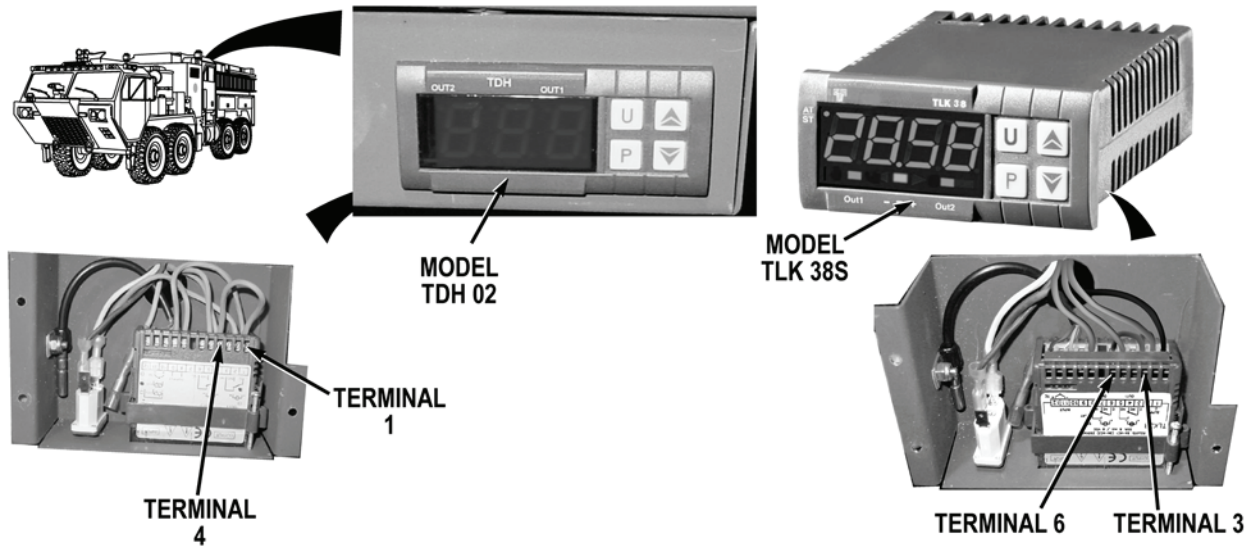

Step 46. Check for 22 to 28 VDC from crew cab air conditioner/heater control panel, terminal 4 for model TDH 02 or terminal 6 for model TLK 38S to a known good ground.

If 22 to 28 VDC are not present, go to Step 48.

Step 47. Check for 22 to 28 VDC from crew cab air conditioner/heater control panel, terminal 1 for model TDH 02 or terminal 3 for model TLK 38S to a known good ground.

- a. If 22 to 28 VDC are present, repair or replace jumperwire from terminal 1 to terminal 9 for model TDH 20 or terminal 2 to terminal 3 for model TLK 38S. (TM 9-2320-325-14&P).
- b. If 22 to 28 VDC are not present, repair or replace jumperwire from terminal 1 to terminal 4 for model TDH 20 or terminal 3 to terminal 6 for model TLK 38S (TM 9-2320-325-14&P).

---

**MALFUNCTION****TEST OR INSPECTION****CORRECTIVE ACTION**

---

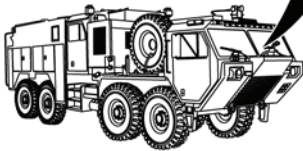
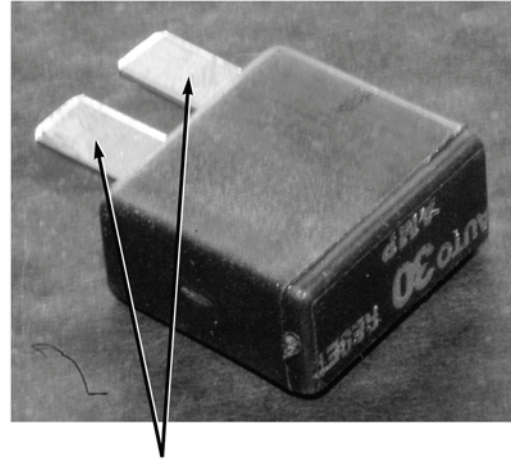
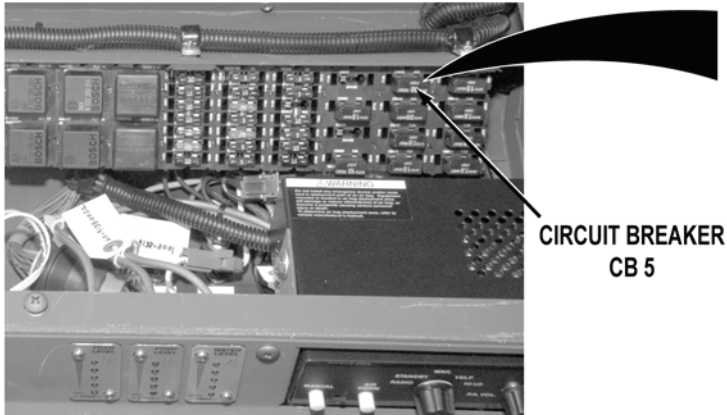

- Step 48. Turn battery disconnect switch to OFF position (WP 0007). Remove cab instrument panel A (WP 0311). Remove circuit breaker CB 5 (WP 0398). Check for continuity across circuit breaker CB 5 terminal connectors.

If continuity is not present, replace circuit breaker CB 5 (WP 0398).

---

**MALFUNCTION**  
**TEST OR INSPECTION**  
**CORRECTIVE ACTION**

---

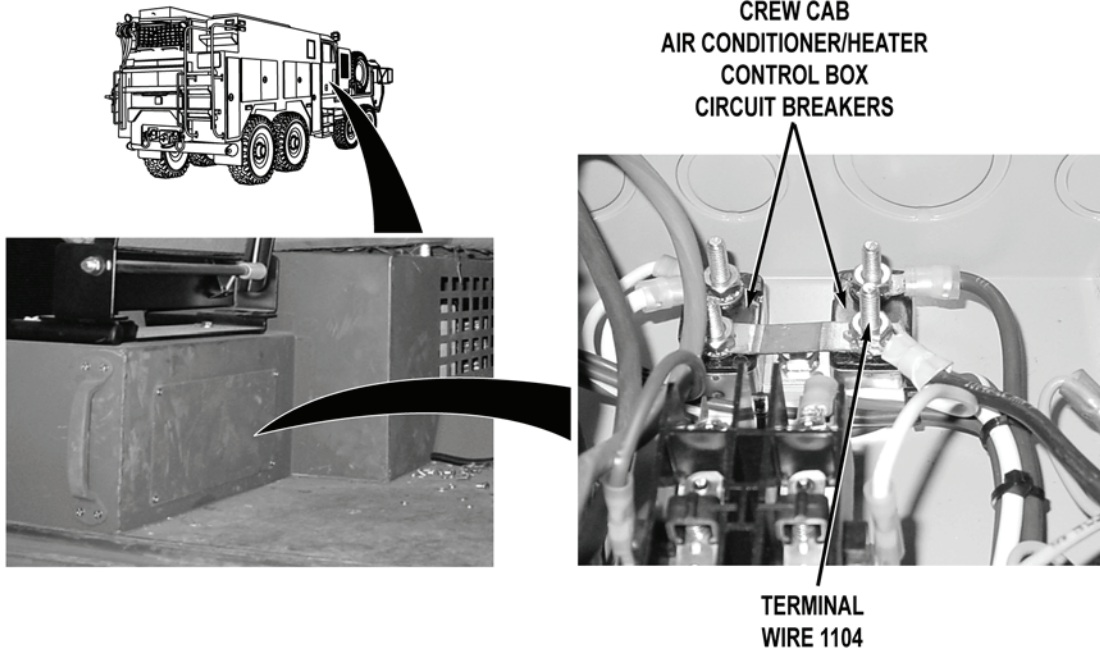

- Step 49. Install circuit breaker CB 5 (WP 0398). Remove crew cab air conditioner/heater control box cover (WP 0201). Turn battery disconnect switch to ON position (WP 0007). Check for 22 to 28 VDC at wire 1104 from crew cab air conditioner/heater control box circuit breaker terminal to a known good ground.

If 22 to 28 VDC are present, replace crew cab air conditioner/heater control box (WP 0201).

**MALFUNCTION****TEST OR INSPECTION****CORRECTIVE ACTION****WARNING**

**Remove rings, wristwatches, neck chains, and any other jewelry before working around vehicle. Jewelry can catch on equipment and cause serious injury. Jewelry and tools may short across electrical circuits and cause damage to equipment, or severe burns or electrical shock to personnel.**

- Step 50. Turn battery disconnect switch to OFF position (WP 0007). Disconnect main wire harness crew cab wire harness connector. Turn battery disconnect switch to ON position (WP 0007). With a test lead set, check for 22 to 28 VDC at wire 1104 from main wire harness crew cab wire harness connector, terminals M and N to a known good ground.

If 22 to 28 VDC are present, repair wire 1104 in crew cab wire harness if repairable (TM 9-2320-325-14&P), or replace crew cab wire harness (WP 0446).

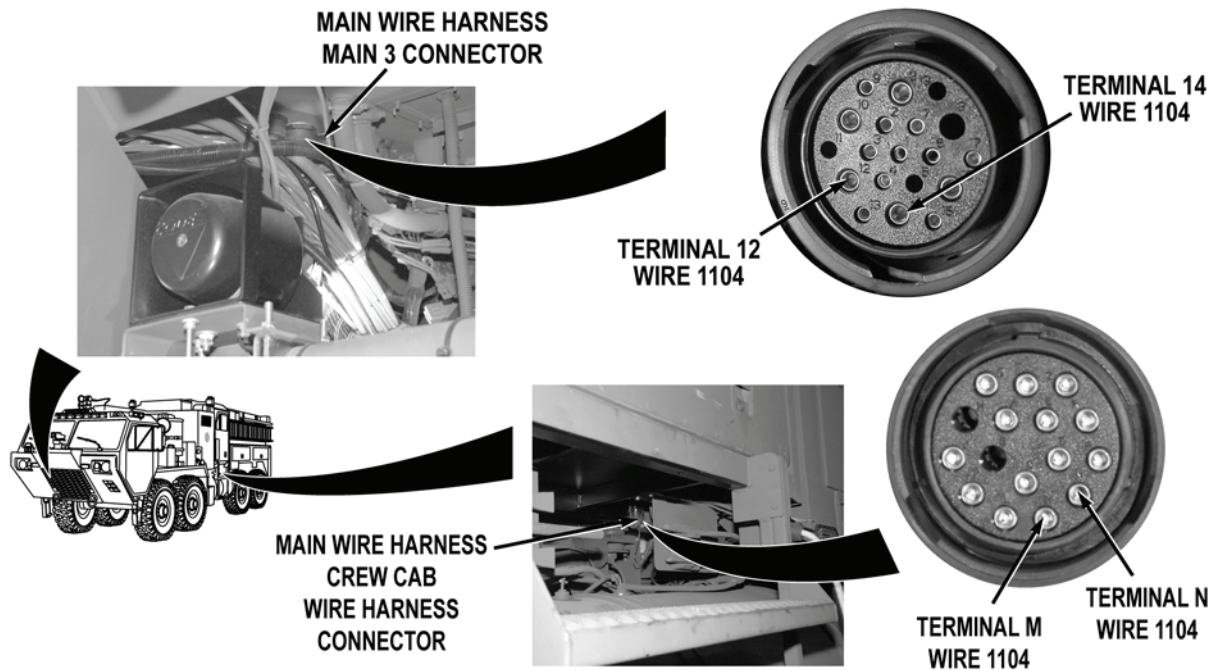
**MALFUNCTION****TEST OR INSPECTION****CORRECTIVE ACTION**

- Step 51. Turn battery disconnect switch to OFF position (WP 0007). Remove skid plate grille (WP 0550). Disconnect main wire harness main 3 connector. With a test lead set, check for continuity across wire 1104 from main wire harness main 3 connector, terminals 12 and 14 to main wire harness crew cab wire harness connector, terminals M and N.
- If continuity is present, repair wire 1104 in cab power distribution wire harness if repairable, (TM 9-2320-325-14&P), or replace cab power distribution wire harness and block (WP 0441).
  - If continuity is not present, repair wire 1104 in main wire harness if repairable (TM 9-2320-325-14&P), or replace main wire harness (WP 0455).

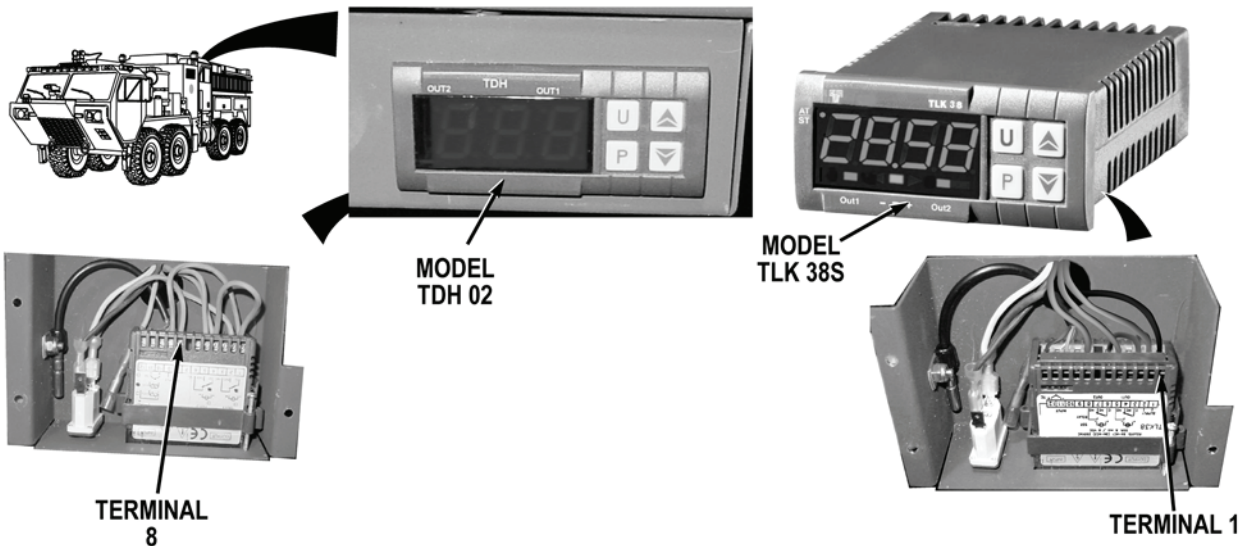
**MALFUNCTION****TEST OR INSPECTION****CORRECTIVE ACTION****NOTE**

Determine which crew cab air conditioner/heater control panel is installed on vehicle for this Step. If model TDH 02 is installed on vehicle, ground terminal is terminal 8. If model TLK 38S is installed on vehicle, ground terminal is terminal 1.

- Step 52. Turn battery disconnect switch to OFF position (WP 0007). Disconnect crew cab air conditioner controller wire harness white wire from control switch. Check for continuity across jumperwire from crew cab air conditioner/heater control panel, terminal to crew cab air conditioner controller wire harness white wire from control switch connector.

If continuity is not present, repair or replace jumperwire (TM 9-2320-325-14&P).

- Step 53. Disconnect crew cab air conditioner controller wire harness black wire from control switch. Check for continuity across black wire from crew cab air conditioner controller wire harness connector to a known good ground.
- a. If continuity is present, replace crew cab air conditioner/heater control panel control switch (WP 0202).
  - b. If continuity is not present, replace air conditioner/heater controller wire harness (WP 0433).

**END OF TASK**

**FOLLOW-ON MAINTENANCE**

1. Install crew cab bench seat if removed (WP 0501)
2. Install skid plate grille if removed (WP 0550)
3. Remove wheel chocks (TM 9-2320-347-10)

**END OF TASK****END OF WORK PACKAGE**





---

**FIELD LEVEL MAINTENANCE**
**CREW CAB AIR CONDITIONER COMPRESSOR EXCESSIVELY NOISY**

---

**INITIAL SETUP:****Tools and Special Tools**

Tool Kit, General Mechanic's: Automotive  
(WP 0622, Item 27)

**Equipment Conditions**

Water pump engine OFF (WP 0022)  
Engine OFF (TM 9-2320-347-10)  
Wheels chocked (TM 9-2320-347-10)

**References**

WP 0210  
WP 0217

---

**MALFUNCTION****TEST OR INSPECTION****CORRECTIVE ACTION**

---

**CREW CAB AIR CONDITIONER COMPRESSOR EXCESSIVELY NOISY****NOTE**

- Technician must be certified in mobile air conditioning system (MOS 52C) to work on refrigerant system of the air conditioner.
- The R134a refrigerant must be recovered before removing any air conditioner refrigerant system components.
- Flushing procedure should be performed any time a compressor is replaced or when expansion valve or dryer becomes clogged. Do not flush through compressor. Flushing removes all refrigerant oil. Do not flush expansion valve; bench check only. Only flush components after refrigerant has been recovered.
- Install a new air conditioner dryer after replacing any air conditioner refrigerant system component. Install dryer only after all air conditioner system flushing is complete.
- Always evacuate air conditioner system before charging.

---

**MALFUNCTION****TEST OR INSPECTION****CORRECTIVE ACTION**

---

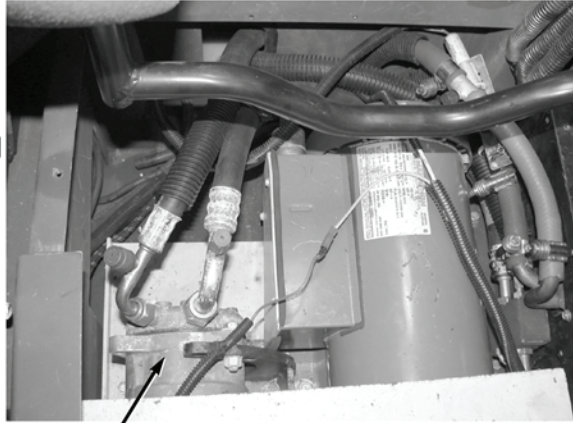

**AIR CONDITIONER  
COMPRESSOR**

Check if air conditioner compressor is installed correctly and free from loose and missing hardware.

- a. If air conditioner compressor is installed correctly, replace compressor (WP 0210) and service air conditioner system (WP 0217).
- b. If air compressor is not installed correctly, or hardware is missing or loose, reinstall air compressor or replace and tighten hardware as required (WP 0210).

**END OF TASK****FOLLOW-ON MAINTENANCE**

Remove wheel chocks (TM 9-2320-347-10)

**END OF TASK****END OF WORK PACKAGE**

**FIELD LEVEL MAINTENANCE**

**CREW CAB AIR CONDITIONER DOES NOT COOL OR COOLS INADEQUATELY**

**INITIAL SETUP:**

**Tools and Special Tools**

- Lead Set, Test (WP 0622, Item 21)
- Leak Test Kit (WP 0622, Item 23)
- Reclaimer, Refrigerant (WP 0622, Item 24)
- Tool Kit, General Mechanic's: Automotive (WP 0622, Item 27)

**Personnel Required**

- MOS 52C Utilities Equipment Repairer

**References**

- WP 0008
- WP 0009
- WP 0070
- WP 0197
- WP 0198
- WP 0200

**References (continued)**

- WP 0206
- WP 0210
- WP 0211
- WP 0213
- WP 0214
- WP 0216
- WP 0217
- WP 0501

**Equipment Conditions**

- Water pump engine OFF (WP 0022)
- Engine OFF (TM 9-2320-347-10)
- Wheels chocked (TM 9-2320-347-10)

**MALFUNCTION**

**TEST OR INSPECTION**

**CORRECTIVE ACTION**

**CREW CAB AIR CONDITIONER DOES NOT COOL OR COOLS INADEQUATELY**

**NOTE**

- The R134a refrigerant must be recovered before removing any air conditioner refrigerant system components.
- Flushing procedure should be performed anytime a compressor is replaced or if expansion valve or dryer becomes clogged. Do not flush through compressor, flushing removes all refrigerant oil. Do not flush expansion valve; bench check only. Only flush components, after refrigerant has been recovered.
- Install a new air conditioner dryer after replacing any air conditioner refrigerant system component. Install dryer only after all air conditioner system flushing is complete.
- Always evacuate air conditioner system before charging.

---

**MALFUNCTION****TEST OR INSPECTION****CORRECTIVE ACTION**

---

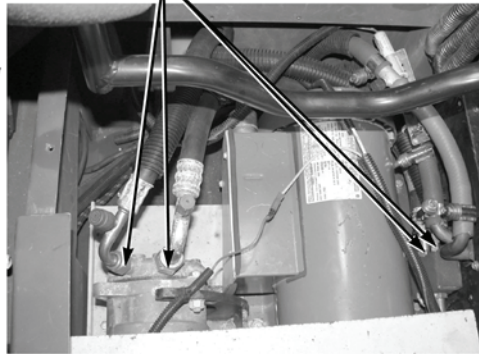
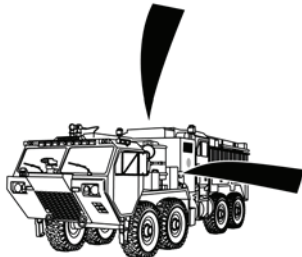

**CREW CAB AIR CONDITIONER  
HOSE CONNECTIONS**

**NOTE**

Refrigerant oil leaks out with refrigerant and leaves an oily film that collects dust leaving a buildup of dirt.

- Step 1. Remove crew cab bench seat and access panel (WP 0501). Visually inspect crew cab air conditioner hose connections for oil and/or dirt buildup.

If any crew cab air conditioner hose connections have oil and/or dirt buildup, replace leaking crew cab air conditioner hoses (WP 0216).

---

**MALFUNCTION****TEST OR INSPECTION****CORRECTIVE ACTION**

---

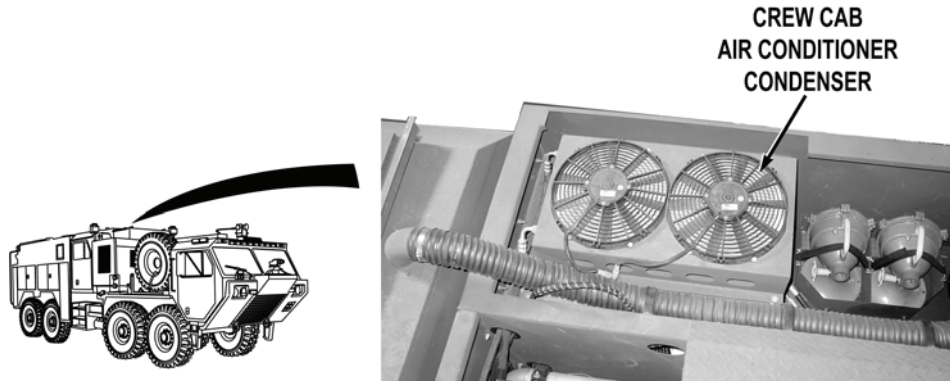

Step 2. Check if crew cab air conditioner condenser is free from damage and blockage.

If crew cab air conditioner condenser is not free from damage or blockage, replace damaged crew cab air conditioner condenser (WP 0211) or clean crew cab air conditioner condenser.

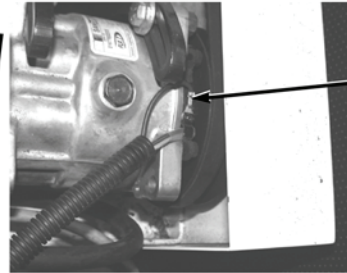
**MALFUNCTION****TEST OR INSPECTION****CORRECTIVE ACTION**

CREW CAB  
AIR CONDITIONER  
COMPRESSOR CLUTCH

CREW CAB  
AIR CONDITIONER  
COMPRESSOR DRIVE BELT

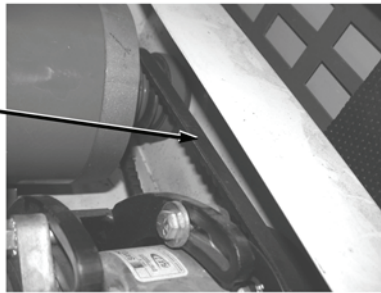
**WARNING**

**Moving compressor components can cause severe injury. Keep away from compressor belts and pulleys while compressor motor is running. Failure to comply may cause serious injury to personnel.**

Step 3. Check if crew cab air conditioner compressor belt is tight and free from damage.

If crew cab air conditioner compressor drive belt is not tight or free from damage, replace crew cab compressor drive belt (WP 0198).

Step 4. Visually inspect if crew cab air conditioner compressor clutch for oil and/or dirt buildup.

If crew cab air conditioner compressor clutch is not free from oil and/or dirt buildup, replace crew cab air conditioner compressor (WP 0210).

**MALFUNCTION****TEST OR INSPECTION****CORRECTIVE ACTION**

**CREW CAB  
AIR CONDITIONER  
EVAPORATOR**

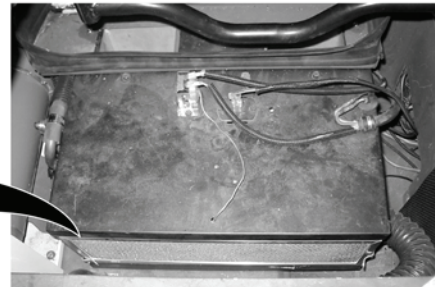
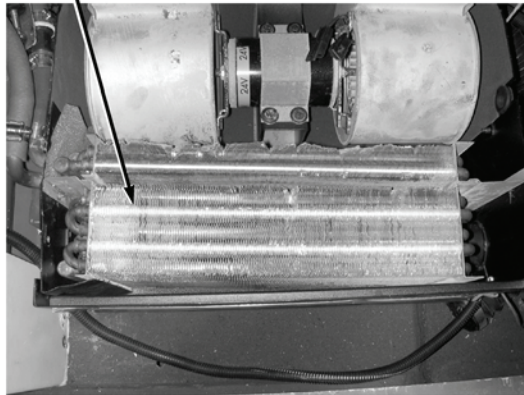

Step 5. Remove air conditioner/heater assembly cover (WP 0200). Check if crew cab air conditioner evaporator is free from damage and blockage.

If crew cab air conditioner evaporator is not free from damage or blockage, replace damaged crew cab air conditioner evaporator (WP 0214) or clean crew cab air conditioner evaporator.

**MALFUNCTION**

**TEST OR INSPECTION**

**CORRECTIVE ACTION**

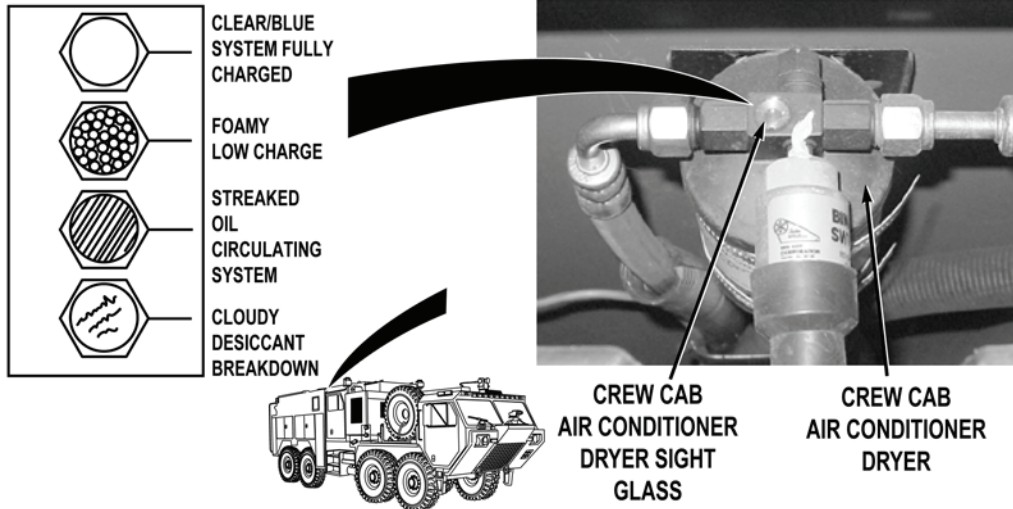

Step 6. Check if crew cab air conditioner dryer sight glass on crew cab air conditioner dryer is blue.

If sight glass is not blue, perform leak test, repair any leaks and service crew cab air conditioner (WP 0217).



**WARNING**



**Moving compressor components can cause severe injury. Keep away from compressor belts and pulleys while compressor motor is running. Failure to comply may cause serious injury to personnel.**

Step 7. Start crew cab air conditioner (WP 0008). Set air conditioner/heater control panel set point to 45° (7°C) (WP 0009). Check if crew cab air conditioner compressor clutch engages.

If crew cab air conditioner compressor clutch engages, go to Step 10.



---

**MALFUNCTION****TEST OR INSPECTION****CORRECTIVE ACTION**

---

**WARNING**

- Use care to prevent refrigerant from touching skin or eyes. Liquid refrigerant, when exposed to air, quickly evaporates and will freeze skin or eye tissues. Serious injury or blindness may result if you come in contact with liquid refrigerant.
- Refrigerant R-134a air conditioning systems should not be pressure-tested or leak-tested with compressed air. Combustible mixture of air and R-134a may form, resulting in a fire or explosion, which could cause personal injury or death.
- Wear protective goggles and non-leather gloves when servicing air conditioning or injury could result.

Step 8. Stop crew cab air conditioner (WP 0008). Connect service/recycling station (WP 0217). Check if crew cab air conditioning system pressure is above 34 PSI (234 kPa) on service/recycling station low-side pressure gauge (WP 0217).

If there is less than 34 PSI (234 kPa), perform leak test, repair leaks, and service crew cab air conditioner (WP 0217).

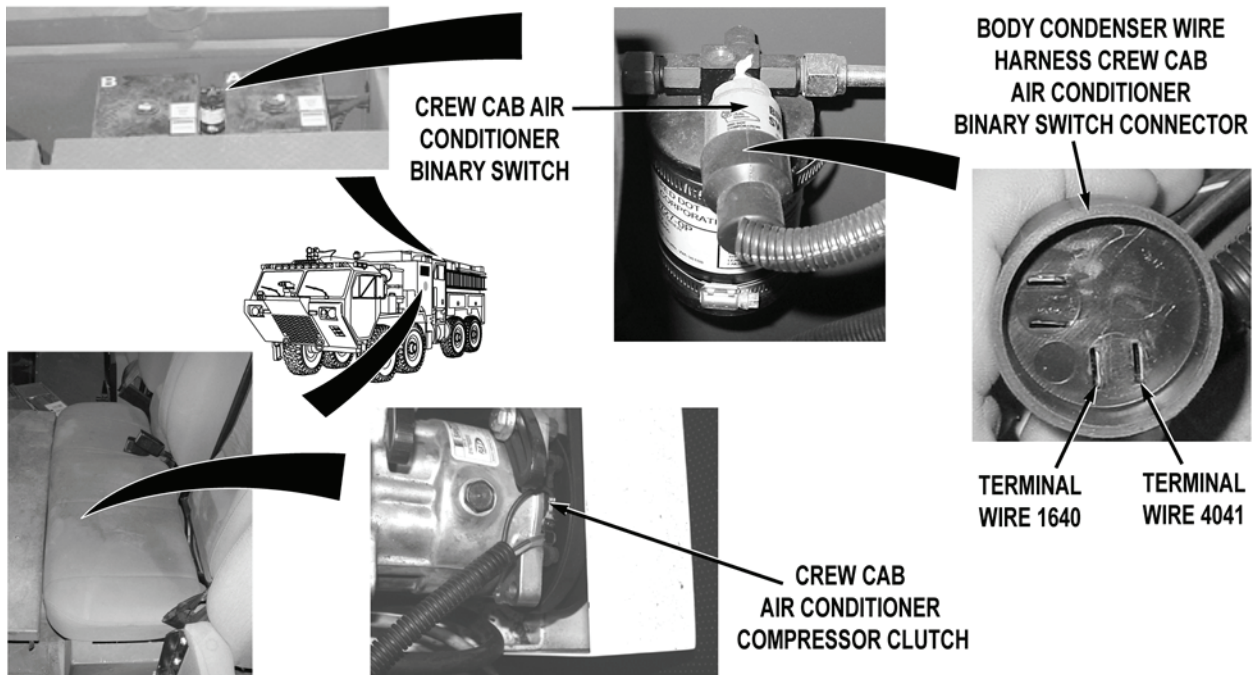
**MALFUNCTION****TEST OR INSPECTION****CORRECTIVE ACTION**

- Step 9. Disconnect body condenser wire harness crew cab air conditioner binary switch connector from crew cab air conditioner binary switch. Install a jumperwire into body condenser wire harness crew cab air conditioner binary switch connector, wire 4041 terminal to wire 1640 terminal. Start crew cab air conditioner (WP 0008). Change crew cab air conditioner control panel set point to 45°F (7°C) (WP 0009). Check if crew cab air conditioner compressor clutch engages.
- a. If crew cab air conditioner compressor clutch does not engage, troubleshoot Crew Cab Air Conditioner/Heater Does Not Operate Properly (WP 0070).
  - b. If crew cab air conditioner compressor clutch engages, replace crew cab air conditioner binary switch (WP 0197).

**MALFUNCTION**

**TEST OR INSPECTION**

**CORRECTIVE ACTION**

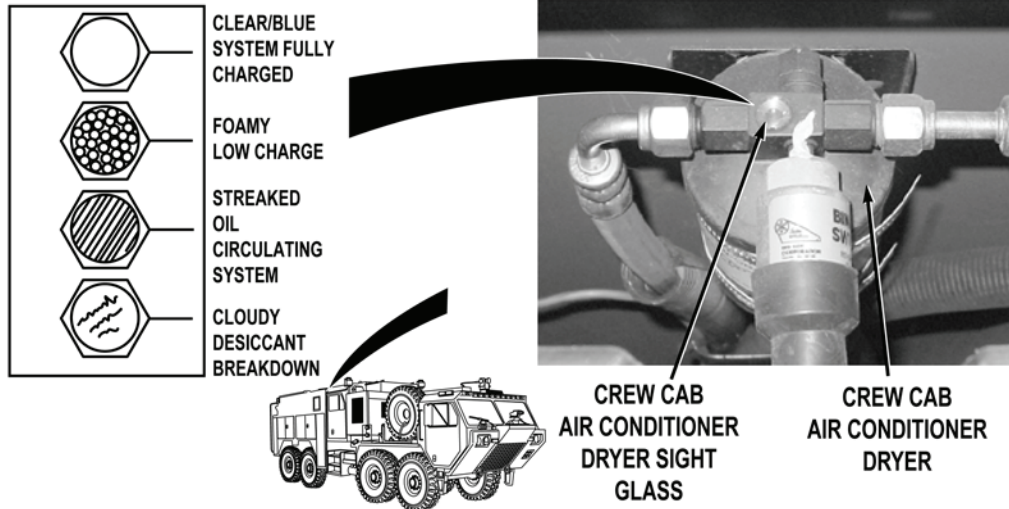

Step 10. Start crew cab air conditioner (WP 0008). Run crew cab air conditioner for five to ten minutes. Check crew cab air conditioner dryer sight glass on crew cab air conditioner dryer for streaks or cloudy appearance.

If crew cab air conditioner dryer sight glass has streaks or cloudy appearance, purge and service crew cab air conditioner (WP 0217).

Step 11. Check crew cab air conditioner dryer sight glass for foam or air bubbles.

If crew cab air conditioner dryer sight glass has foam or bubbles, perform leak test and service crew cab air conditioner (WP 0217).

Step 12. Check if crew cab air conditioner compressor makes noise during operation.

If crew cab air conditioner compressor makes noise during operation, replace crew cab air conditioner compressor (WP 0210).

**MALFUNCTION**

**TEST OR INSPECTION**

**CORRECTIVE ACTION**

**PRESSURE TEMPERATURE CHART**

°F	°C	HFC-134A (PSI)	°F	°C	HFC-134A (PSI)
0	-17.8	6.5	85	29.4	94.9
5	-15.0	9.0	90	32.2	103.9
10	-12.2	12.0	95	35.0	113.5
15	-9.4	15.0	100	37.8	123.6
20	-6.7	18.4	105	40.6	134.3
25	-3.9	22.1	110	43.3	145.3
30	-1.1	26.1	115	46.1	157.6
35	1.7	30.4	120	48.9	170.3
40	4.4	35.0	125	51.7	183.6
45	7.2	40.0	130	54.4	197.6
50	10.0	45.3	135	57.2	212.4
55	12.8	51.1	140	60.0	227.9
60	15.6	57.3	145	62.8	244.3
65	18.3	63.9	150	65.6	261.4
70	21.1	70.9	155	68.3	279.5
75	23.8	78.4	160	71.1	298.4
80	26.7	88.4	165	73.9	318.3

**WARNING**



- Use care to prevent refrigerant from touching skin or eyes. Liquid refrigerant, when exposed to air, quickly evaporates and will freeze skin or eye tissues. Serious injury or blindness may result if you come in contact with liquid refrigerant.
- Refrigerant R-134a air conditioning systems should not be pressure-tested or leak-tested with compressed air. Combustible mixture of air and R-134a may form, resulting in a fire or explosion, which could cause personal injury or death.
- Wear protective goggles and non-leather gloves when servicing air conditioning or injury could result.

**NOTE**

- Temperature of R-134a refrigerant at low-side service value determines system high-side pressure as indicated in chart shown above.
- Ambient temperature of air surrounding air conditioner condenser determines system high-side pressure as indicated in chart shown above. Ambient temperature is determined by measuring temperature 2 inches in front of air conditioner condenser.

Step 13. Stop crew cab air conditioner (WP 0008). Connect service/recycling station (WP 0217). Start crew cab air conditioner (WP 0008). Check if service/recycling station pressure gauges cycle between 15 PSI and 40 PSI (103-276 kPa) low-side pressure, and between 120 and 330 PSI (827-2275 kPa) high-side pressure and air is only slightly cool (WP 0217).

If service/recycle station pressure gauges do not cycle at 15 PSI and 40 PSI (103-276 kPa) low-side pressure and 120 and 330 PSI (827-2275 kPa) high-side pressure and air is not slightly cool, go to Step 15.

---

**MALFUNCTION****TEST OR INSPECTION****CORRECTIVE ACTION**

---

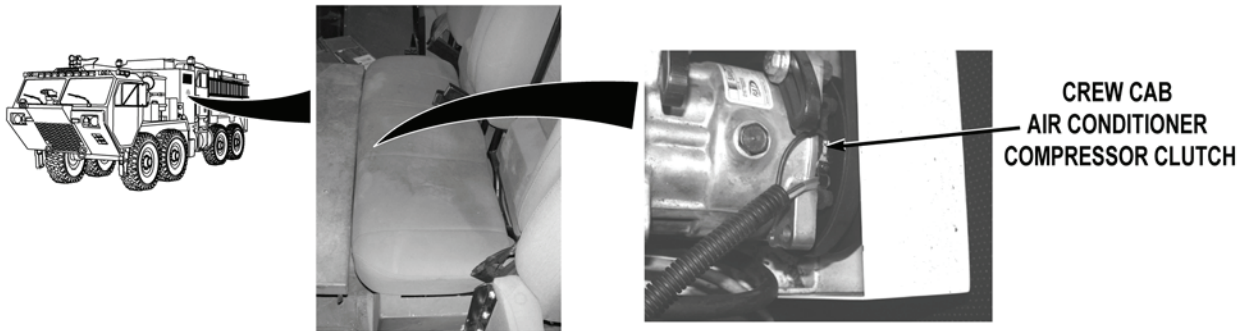

Step 14. Check if air conditioner compressor clutch engages and disengages quickly.

- a. If air conditioner compressor clutch engages and disengages quickly, perform leak test and service crew cab air conditioner (WP 0217).
- b. If air conditioner compressor clutch does not disengage, replace crew cab air conditioner thermostatic switch (WP 0206).

Step 15. Check if service/recycling station pressure gauges are below 15 PSI and 40 PSI (103-276 kPa) low-side pressure and below 120 and 330 PSI (827-2275 kPa) high-side pressure and air only slightly cool.

If service/recycling station pressure gauges pressure are not below 15 PSI and 40 PSI (103-276 kPa) low-side pressure and below 120 and 330 (827-2275 kPa) high-side pressure and air is not slightly cool, go to Step 17.

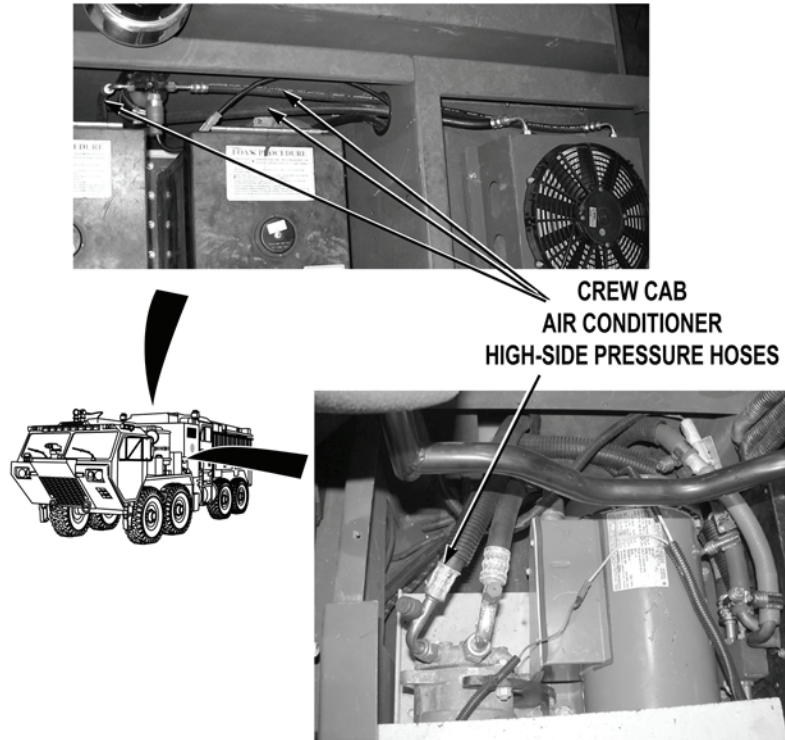
**MALFUNCTION****TEST OR INSPECTION****CORRECTIVE ACTION**

- Step 16. Check crew cab air conditioner high-side pressure hoses for sign of frost buildup.
- a. If crew cab air conditioner high-side pressure hoses have sign of frost buildup, replace frosted crew cab air conditioner hose (WP 0216).
  - b. If crew cab air conditioner high-side pressure hoses do not have sign of frost buildup, replace crew cab air conditioner expansion valve (WP 0213).
- Step 17. Check if service/recycling station pressure gauges pressure is above 15 PSI and 40 PSI (103-276 kPa) low-side pressure and above 120 and 330 PSI (827-2275 kPa) high-side pressure and if air is warm.

If service/recycling station pressure gauges are not above 15 PSI and 40 PSI (103-276 kPa) low-side pressure and above 120 and 330 PSI (827-2275 kPa) high-side pressure and air is warm, go to Step 19.

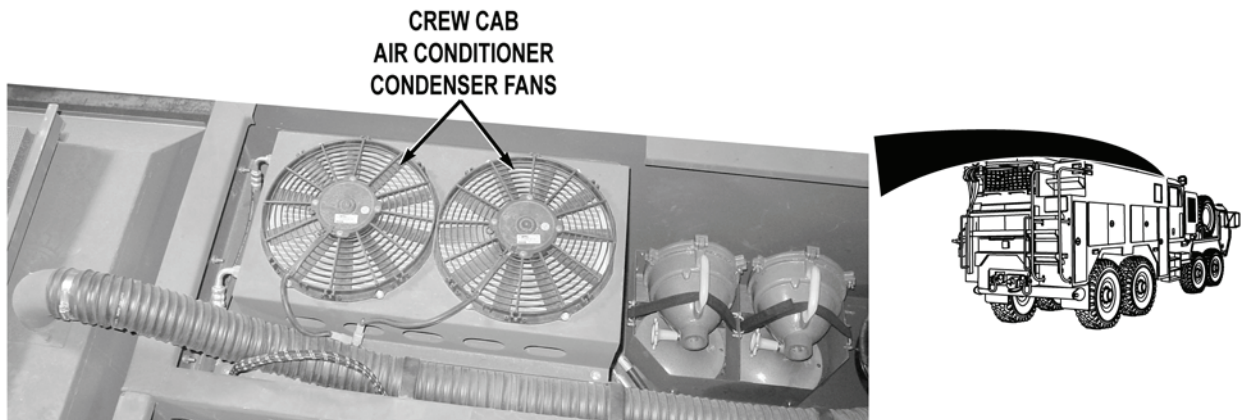
**MALFUNCTION****TEST OR INSPECTION****CORRECTIVE ACTION**

Step 18. Check if crew cab air conditioner condenser fans operate.

- a. If crew cab air conditioner condenser fans operate, replace crew cab air conditioner expansion valve (WP 0213).
- b. If crew cab air conditioner condenser fans do not operate, troubleshoot Crew Cab Air Conditioner/Heater Does Not Operate Properly (WP 0070).

Step 19. Check if service/recycling station pressure gauges are above 15 PSI and 40 PSI (103-276 kPa) low-side pressure and below 120 and 330 PSI (828-2275 kPa) high-side pressure if air is warm.

- a. If service/recycling station pressure gauges are above 15 PSI and 40 PSI (103-276 kPa) low-side pressure and below 120 and 330 PSI (828-2275 kPa) high-side pressure and air is warm, replace crew cab air conditioner compressor (WP 0210).
- b. If service/recycling station pressure gauges are not above 15 PSI and 40 PSI (103-276 kPa) low-side pressure and below 120 and 330 PSI (828-2275 kPa) high-side pressure and air is not warm, fault corrected.

**END OF TASK****FOLLOW-ON MAINTENANCE**

1. Install crew cab bench seat if removed (WP 0501)
2. Remove wheel chocks (TM 9-2320-347-10)

**END OF TASK****END OF WORK PACKAGE**





---

**FIELD LEVEL MAINTENANCE**
**WATER PUMP ENGINE CRANKS BUT WILL NOT START OR HARD TO START FROM PERSONNEL CAB  
AND PUMP OPERATOR'S PANEL**

---

**INITIAL SETUP:****Tools and Special Tools**

Lead Set, Test (WP 0622, Item 21)  
 Tool Kit, General Mechanic's: Automotive  
 (WP 0622, Item 27)

**References**

(TM 9-2320-325-14&P)  
 WP 0007  
 WP 0022  
 WP 0235  
 WP 0237

**References (continued)**

WP 0394  
 WP 0413  
 WP 0457  
 WP 0459

**Equipment Conditions**

Water pump engine OFF (WP 0022)  
 Engine OFF (TM 9-2320-347-10)  
 Wheels chocked (TM 9-2320-347-10)

---

**MALFUNCTION****TEST OR INSPECTION****CORRECTIVE ACTION**

---

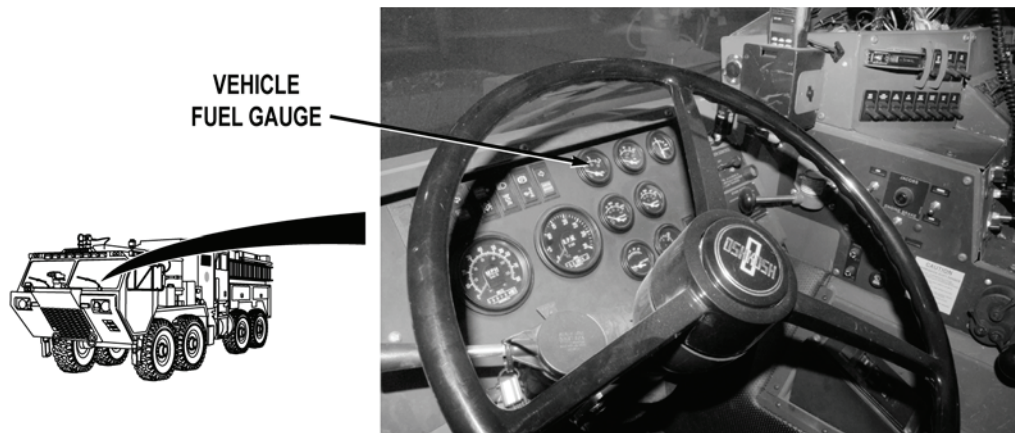
**WATER PUMP ENGINE CRANKS BUT WILL NOT START OR HARD TO START FROM PERSONNEL CAB  
AND PUMP OPERATOR'S PANEL**

Step 1. Turn vehicle ENGINE START switch to ON position (TM 9-2320-347-10). Check vehicle fuel gauge for fuel level.

If fuel level is low, fill fuel tank (TM 9-2320-347-10).

Step 2. Start water pump engine (WP 0022). Check if water pump engine starts.

- a. If water pump engine starts, fault corrected.
- b. If water pump engine starts then stops, go to Step 13.
- c. If water pump engine does not start go to Step 3.

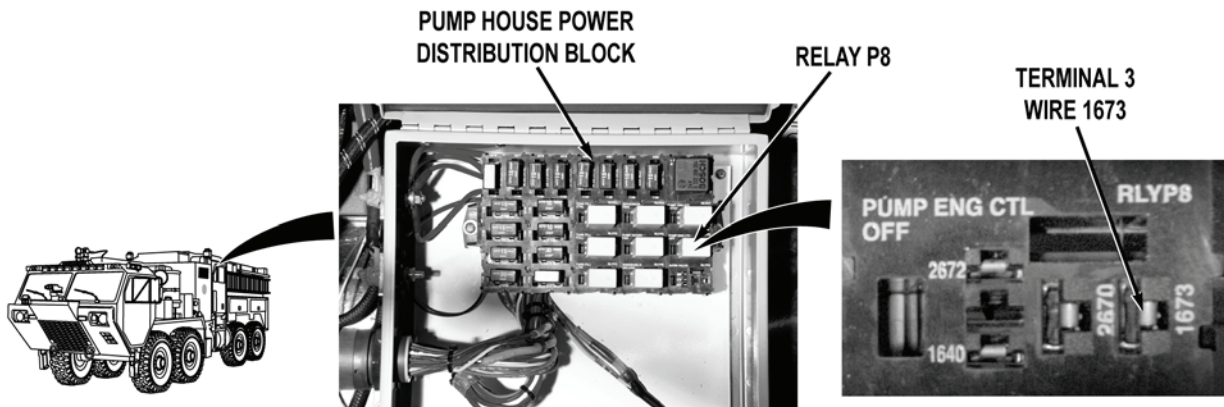
**MALFUNCTION****TEST OR INSPECTION****CORRECTIVE ACTION****WARNING**

**Remove rings, wristwatches, neck chains, and any other jewelry before working around vehicle. Jewelry can catch on equipment and cause serious injury. Jewelry and tools may short across electrical circuits and cause damage to equipment, or severe burns or electrical shock to personnel.**

- Step 3. Turn battery disconnect switch to OFF position (WP 0007). Remove relay P8 from pump house power distribution block. Turn battery disconnect switch to ON position (WP 0007). Check for 22 to 28 VDC at pump house distribution block wire 1673 (brown), terminal 3 to a known good ground.

If 22 to 28 VDC are present, go to Step 6.

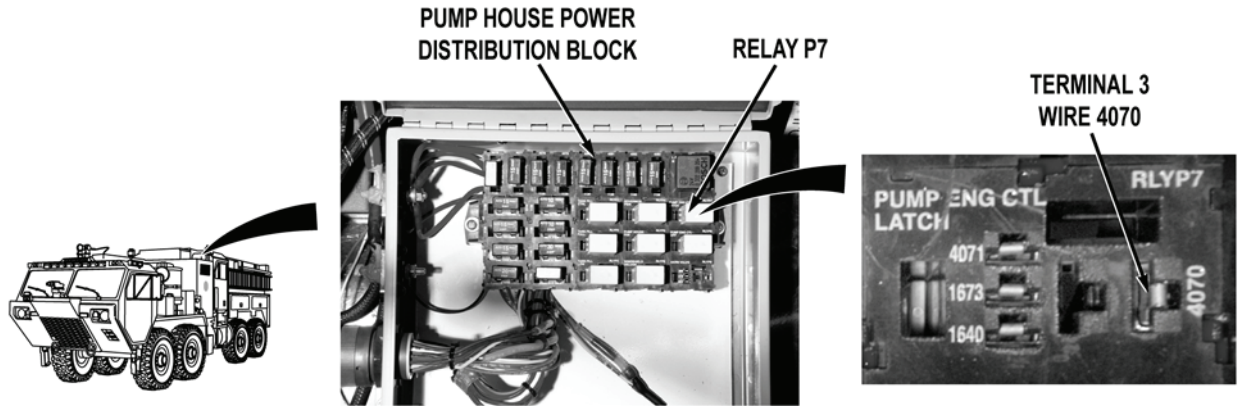
**MALFUNCTION****TEST OR INSPECTION****CORRECTIVE ACTION**

- Step 4. Turn battery disconnect switch to OFF position (WP 0007). Remove relay P7 from pump house power distribution block. Turn battery disconnect switch to ON position (WP 0007). Check for 22 to 28 VDC at pump house distribution block wire 4070 (white), terminal 3 to a known good ground.

If 22 to 28 VDC are not present, repair wire 4070 in pump house power distribution wire harness if repairable (TM 9-2320-325-14&P), or replace pump house power distribution wire harness and block (WP 0457).

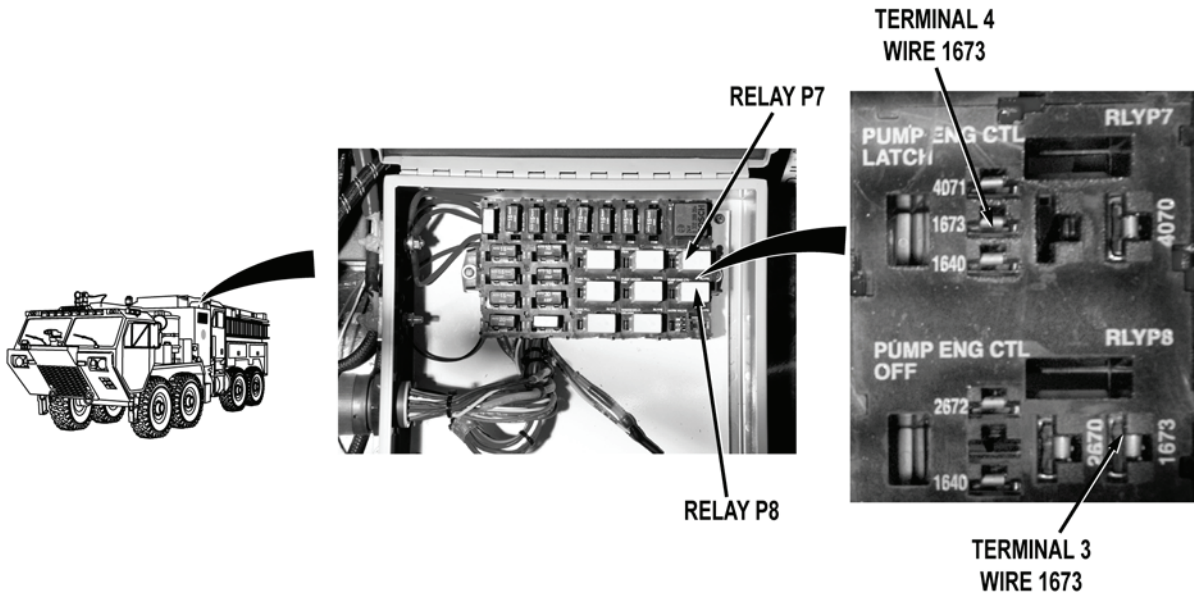
**MALFUNCTION****TEST OR INSPECTION****CORRECTIVE ACTION**

- Step 5. Check for continuity across wire 1673 (brown) from relay P7, terminal 4 to relay P8, terminal 3.
- a. If continuity is present, replace relay P7 (WP 0413).
  - b. If continuity is not present, repair wire 1673 in pump house power distribution wire harness if repairable (TM 9-2320-325-14&P), or replace pump house power distribution wire harness and block (WP 0457).

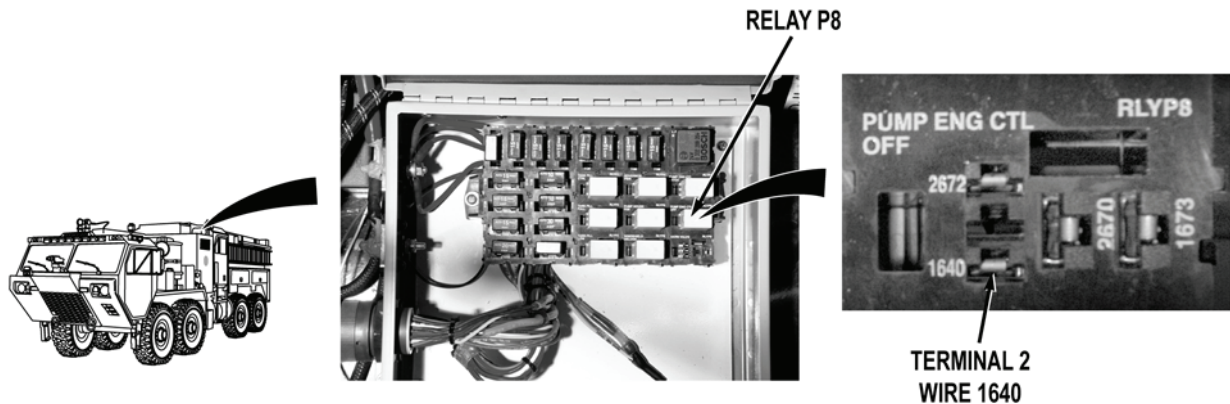
**MALFUNCTION****TEST OR INSPECTION****CORRECTIVE ACTION****WARNING**

**Remove rings, wristwatches, neck chains, and any other jewelry before working around vehicle. Jewelry can catch on equipment and cause serious injury. Jewelry and tools may short across electrical circuits and cause damage to equipment, or severe burns or electrical shock to personnel.**

- Step 6. Turn battery disconnect switch to OFF position (WP 0007). Check for continuity across wire 1640 (black) terminal 2 at relay P8 to a known good ground.

If continuity is not present, repair wire 1640 in pump house power distribution wire harness if repairable (TM 9-2320-325-14&P), or replace pump house power distribution wire harness and block (WP 0457).

---

**MALFUNCTION****TEST OR INSPECTION****CORRECTIVE ACTION**

---

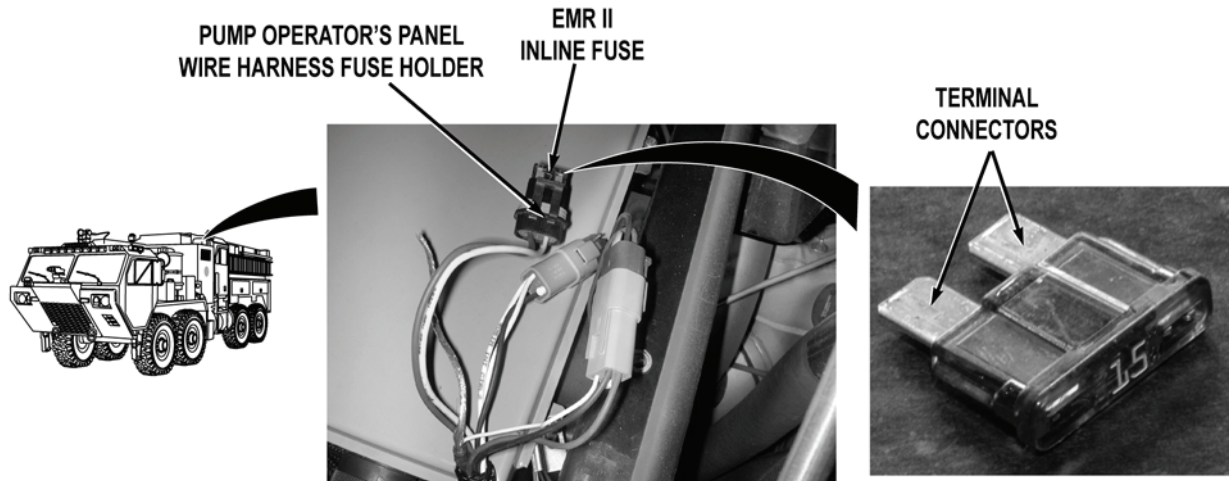

Step 7. Remove EMR II inline fuse from pump operator's panel wire harness fuse holder (WP 0394). Check for continuity across EMR II inline fuse terminal connectors.

If continuity is not present, replace EMR II inline fuse (WP 0394).

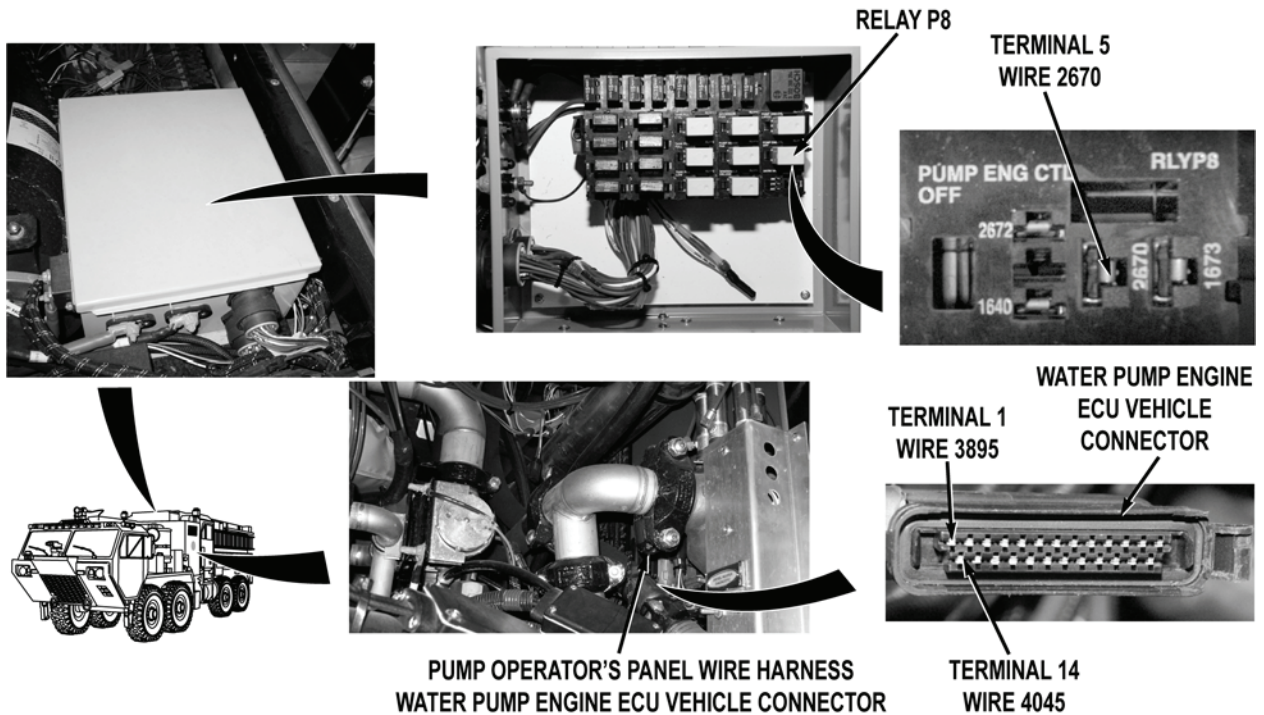
**MALFUNCTION****TEST OR INSPECTION****CORRECTIVE ACTION**

- Step 8. Install EMR II inline fuse (WP 0394). Disconnect pump operator's panel wire harness water pump engine ECU vehicle connector. Check for continuity across wire 2670 (yellow) from relay P8, terminal 5 to water pump engine ECU vehicle connector wire 4045 (red), terminal 14.

If continuity is not present, go to Step 11.

- Step 9. Check for continuity across wire 3895 (black) from water pump engine ECU vehicle connector, terminal 1 to a known good ground.

If continuity is not present, repair wire 3895 in pump operator's panel wire harness if repairable (TM 9-2320-325-14&P), or replace pump operator's panel wire harness (WP 0459).

---

**MALFUNCTION****TEST OR INSPECTION****CORRECTIVE ACTION**

---

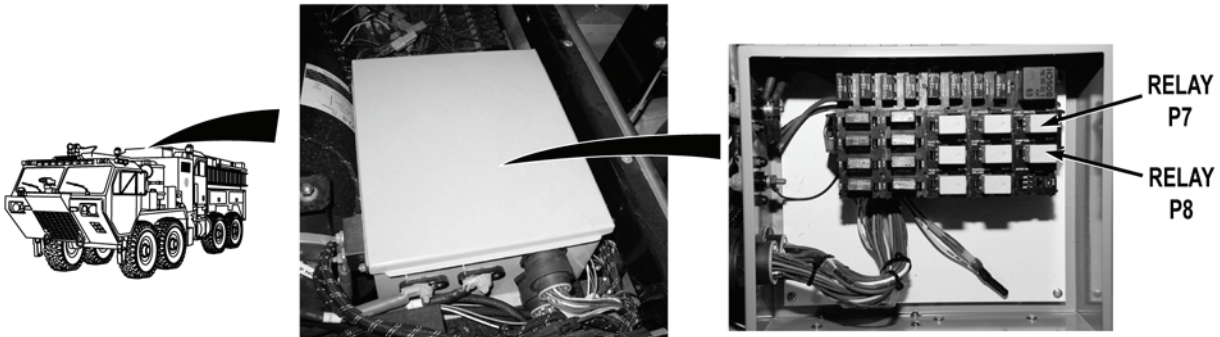

- Step 10. Swap relays P7 and P8. Start water pump engine (WP 0022). Check if water pump engine starts.
- a. If water pump engine starts and stays running, replace relay P8 (WP 0413).
  - b. If water pump engine starts and stops, replace pump house power distribution wire harness and block (WP 0457).
  - c. If water pump engine does not start, notify Supervisor.



**MALFUNCTION**

**TEST OR INSPECTION**

**CORRECTIVE ACTION**



PUMP OPERATOR'S PANEL  
WIRE HARNESS EMR II  
INLINE FUSE HOLDER



TERMINAL  
WIRE 4045

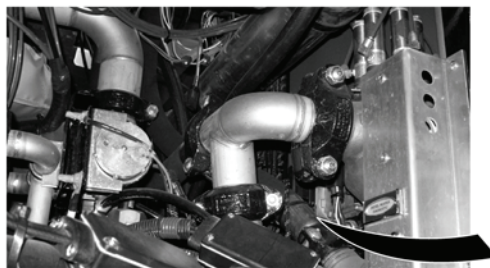
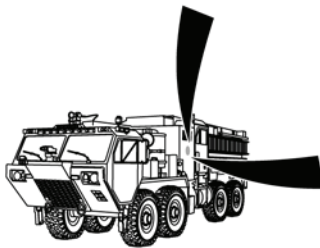

WATER PUMP ENGINE  
ECU VEHICLE  
CONNECTOR

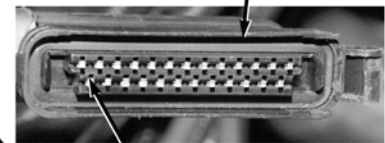

TERMINAL 14  
WIRE 4045

**WARNING**



**Remove rings, wristwatches, neck chains, and any other jewelry before working around vehicle. Jewelry can catch on equipment and cause serious injury. Jewelry and tools may short across electrical circuits and cause damage to equipment, or severe burns or electrical shock to personnel.**

- Step 11. Remove EMR II inline fuse from pump operator's panel wire harness EMR II inline fuse holder. With a test lead set, check for continuity across wire 4045 (red) from EMR II inline fuse holder terminal to water pump engine ECU vehicle connector, terminal 14.

If continuity is not present, repair wire 4045 in pump operator's panel wire harness if repairable (TM 9-2320-325-14&P), or replace pump operator's panel wire harness (WP 0459).

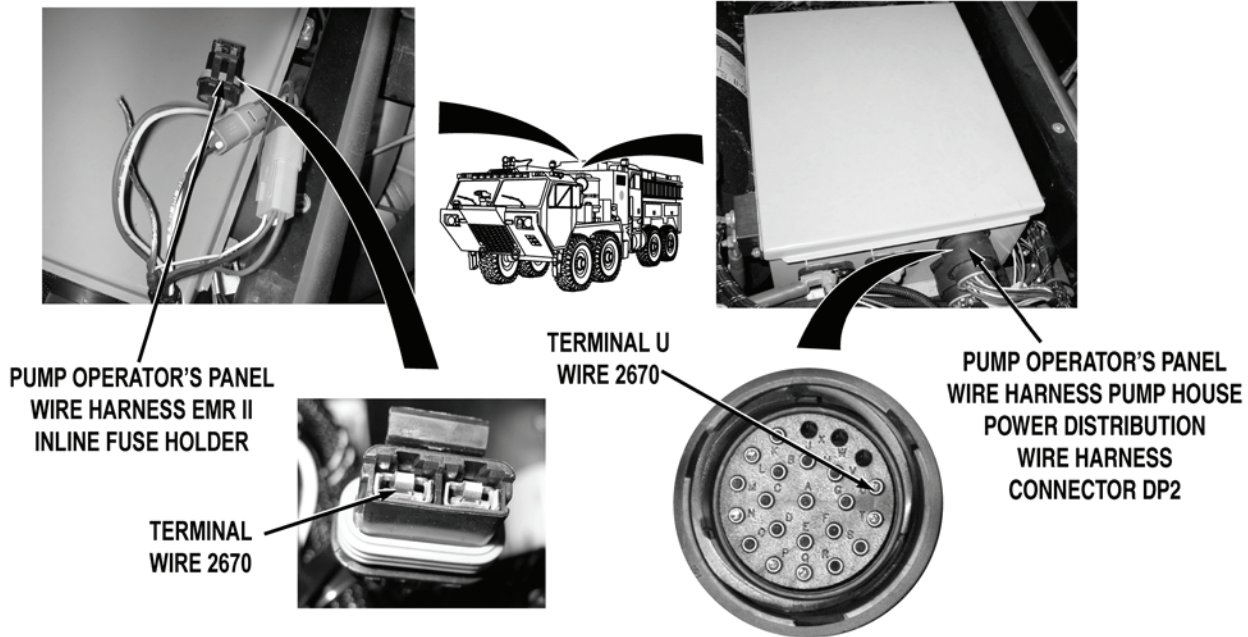
**MALFUNCTION****TEST OR INSPECTION****CORRECTIVE ACTION**

- Step 12. Disconnect pump operator's panel wire harness pump house power distribution wire harness connector DP2. With a test lead set, check for continuity across wire 2670 (yellow) from pump operator's panel wire harness pump house power distribution connector DP2, terminal U to pump operator's panel wire harness EMR II inline fuse holder terminal.
- a. If continuity is present, repair wire 2670 in pump house power distribution wire harness if repairable (TM 9-2320-325-14&P), or replace pump house power distribution wire harness and block (WP 0457).
  - b. If continuity is not present, repair wire 2670 in pump operator's panel wire harness if repairable (TM 9-2320-325-14&P), or replace pump operator's panel wire harness (WP 0459).
- Step 13. Bleed water pump engine primary fuel filter (WP 0237). Check for presence of air.
- If air is present, replace water pump fuel system supply line check valve (WP 0235).
- Step 14. Bleed water pump engine fuel system at return line (WP 0237). Check for presence of air.
- If air is present, replace water pump engine fuel system return line check valve (WP 0235).

---

**MALFUNCTION****TEST OR INSPECTION****CORRECTIVE ACTION**

---

- Step 15. Swap relays P7 and P8 (WP 0413). Start water pump engine (WP 0022). Check if water pump engine starts.
- a. If water pump engine starts and stays running, replace relay P8 (WP 0413).
  - b. If water pump engine starts and stops, replace pump house power distribution wire harness and block (WP 0457).
  - c. If water pump engine does not start, notify Supervisor.

**END OF TASK****FOLLOW-ON MAINTENANCE**

Remove wheel chocks (TM 9-2320-347-10)

**END OF TASK****END OF WORK PACKAGE**



**FIELD LEVEL MAINTENANCE**

**WATER PUMP ENGINE FAILS TO CRANK FROM PERSONNEL CAB AND PUMP OPERATOR'S PANEL**

**INITIAL SETUP:**

**Tools and Special Tools**

- Lead Set, Test (WP 0622, Item 21)
- Tool Kit, General Mechanic's: Automotive (WP 0622, Item 27)

**References**

- TM 9-2320-325-14&P
- WP 0007
- WP 0019
- WP 0022
- WP 0075
- WP 0076
- WP 0248
- WP 0325
- WP 0368

**References (continued)**

- WP 0412
- WP 0455
- WP 0457
- WP 0458
- WP 0459
- WP 0464
- WP 0499
- WP 0540

**Equipment Conditions**

- Water pump engine OFF (WP 0022)
- Engine OFF (TM 9-2320-347-10)
- Wheels chocked (TM 9-2320-347-10)

**MALFUNCTION**

**TEST OR INSPECTION**

**CORRECTIVE ACTION**

**WATER PUMP ENGINE FAILS TO CRANK FROM PERSONNEL CAB AND PUMP OPERATOR'S PANEL**

**MALFUNCTION****TEST OR INSPECTION****CORRECTIVE ACTION**

**START PUMP  
STOP SWITCH**



**START PUMP ENGINE  
STOP SWITCH**



- Step 1. Turn battery disconnect switch to ON position (WP 0007). Put cab START PUMP STOP switch to START position (WP 0022). Check if pump engine cranks from cab position.

If pump engine cranks from cab position, troubleshoot Water Pump Engine Fails To Crank From Pump Operator's Panel (WP 0076).

- Step 2. Open pump operator's panel (WP 0019). Put pump operator's panel START PUMP ENGINE STOP switch to START position (WP 0022). Check if pump engine cranks from pump operator's panel position.

If pump engine cranks from pump operator's panel position, troubleshoot Water Pump Engine Fails To Crank From Personnel Cab (WP 0075).

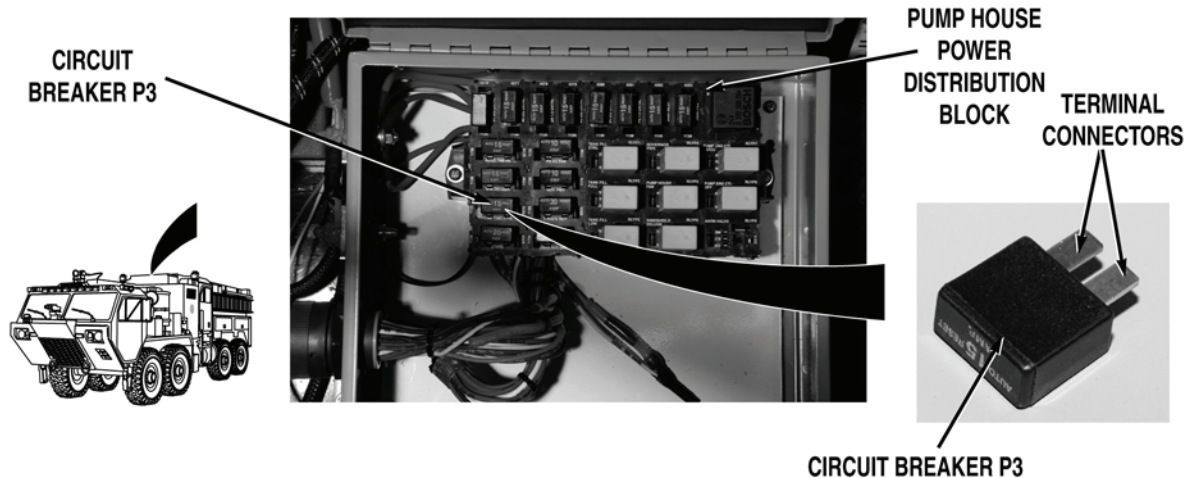
**MALFUNCTION****TEST OR INSPECTION****CORRECTIVE ACTION****WARNING**

**Remove rings, wristwatches, neck chains, and any other jewelry before working around vehicle. Jewelry can catch on equipment and cause serious injury. Jewelry and tools may short across electrical circuits and cause damage to equipment, or severe burns or electrical shock to personnel.**

- Step 3. Turn battery disconnect switch to OFF position (WP 0007). Remove pump house panel S (WP 0540). Open pump house power distribution (WP 0412). Remove circuit breaker P3 (WP 0412). Check for continuity across circuit breaker.

If there is no continuity, replace circuit breaker P3 (WP 0412).

**MALFUNCTION****TEST OR INSPECTION****CORRECTIVE ACTION**

**START PUMP  
ENGINE STOP  
SWITCH**

**TERMINAL  
WIRE 4070**

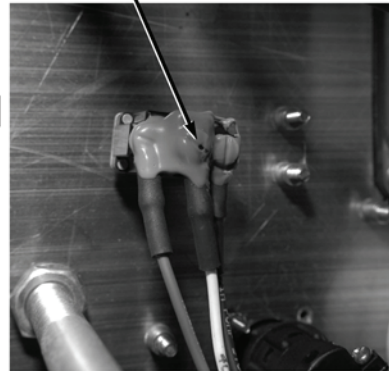
**WARNING**

**Remove rings, wristwatches, neck chains, and any other jewelry before working around vehicle. Jewelry can catch on equipment and cause serious injury. Jewelry and tools may short across electrical circuits and cause damage to equipment, or severe burns or electrical shock to personnel.**

- Step 4. Open pump operator's panel housing (WP 0325). Turn battery disconnect switch to ON position (WP 0007). Check for 22 to 28 VDC between pump operator's panel wire harness wire 4070 (white) at pump operator's panel wire harness START PUMP ENGINE STOP switch, terminal and a known good ground.

If 22 to 28 VDC are not present, go to Step 12.

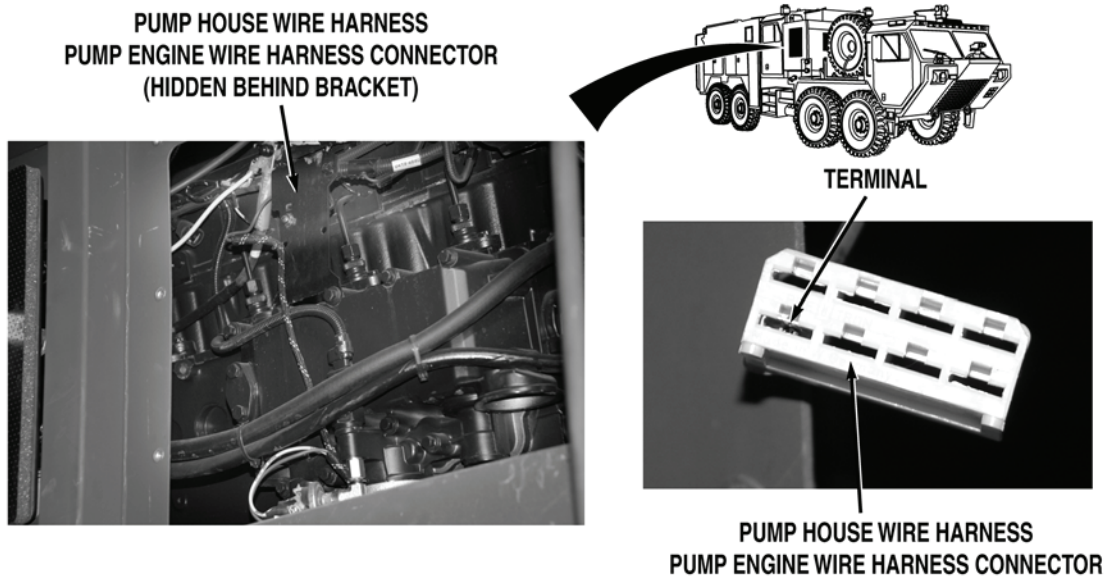

**MALFUNCTION****TEST OR INSPECTION****CORRECTIVE ACTION****WARNING**

**Remove rings, wristwatches, neck chains, and any other jewelry before working around vehicle. Jewelry can catch on equipment and cause serious injury. Jewelry and tools may short across electrical circuits and cause damage to equipment, or severe burns or electrical shock to personnel.**

- Step 5. Turn battery disconnect switch to OFF position (WP 0007). Remove passenger side crew cab access panel (WP 0499). Remove pump house panel P (WP 0540). Disconnect pump house wire harness pump engine wire harness connector. Turn battery disconnect switch to ON position (WP 0007). While an assistant puts cab or pump operator's panel START PUMP ENGINE STOP switch to START position (WP 0022), check for 22 to 28 VDC between pump house wire harness wire 4072 (green) at pump house wire harness pump engine wire harness connector, terminal and a known good ground.

If 22 to 28 VDC are present, go to Step 7.

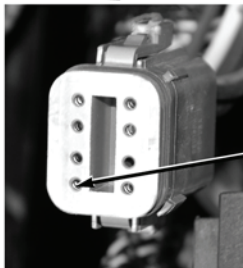
**MALFUNCTION****TEST OR INSPECTION****CORRECTIVE ACTION**

TERMINAL 4  
WIRE 4072

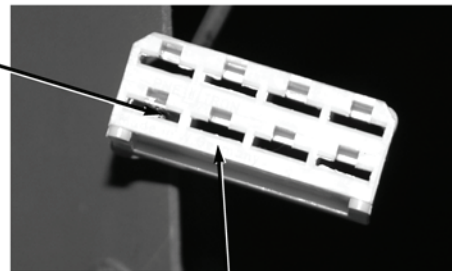
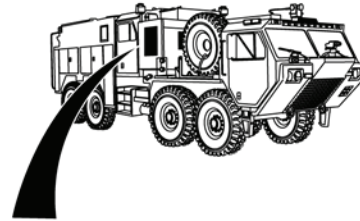

PUMP HOUSE WIRE HARNESS  
PUMP ENGINE WIRE HARNESS CONNECTOR

- Step 6. Turn battery disconnect switch to OFF position (WP 0007). Remove pump house panel S (WP 0540). Disconnect main wire harness pump house wire harness connector. With a test lead set, check for continuity across pump house wire harness wire 4072 (green) from main wire harness pump house wire harness connector, terminal 4 to pump house wire harness pump engine wire harness, terminal.
- a. If there is continuity, repair wire 4072 (green) in main wire harness if repairable (TM 9-2320-325-14&P), or replace main wire harness (WP 0455).
  - b. If there is no continuity, repair wire 4072 (green) in pump house wire harness if repairable (TM 9-2320-325-14&P), or replace pump house wire harness (WP 0458).

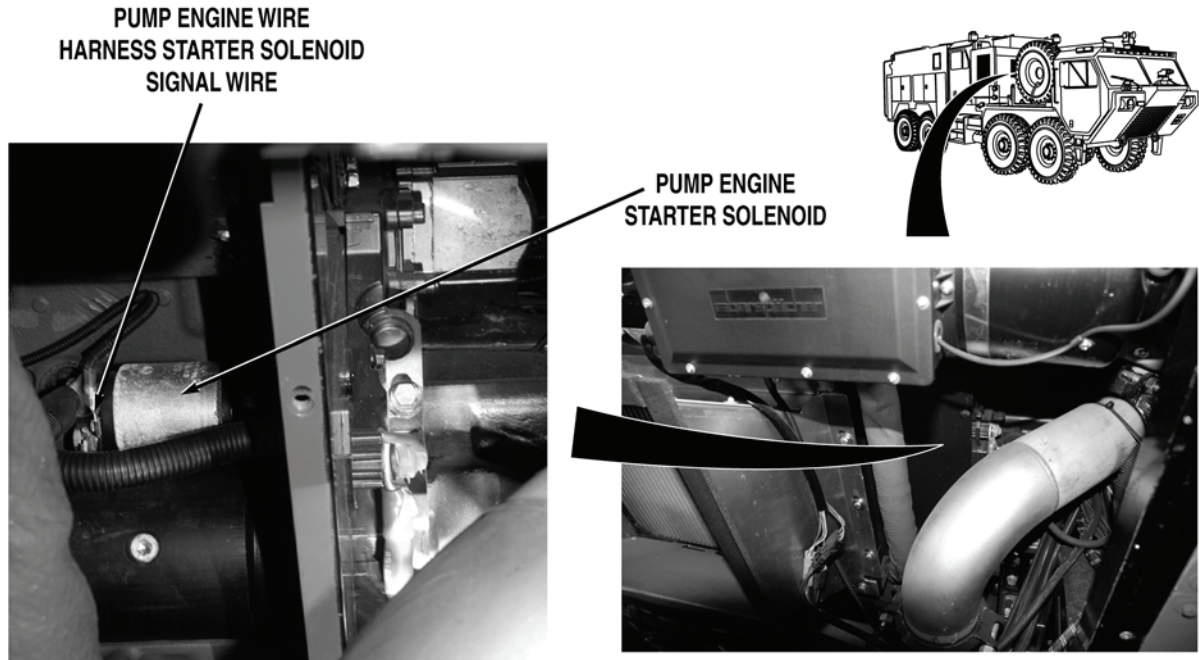
**MALFUNCTION****TEST OR INSPECTION****CORRECTIVE ACTION****WARNING**

**Remove rings, wristwatches, neck chains, and any other jewelry before working around vehicle. Jewelry can catch on equipment and cause serious injury. Jewelry and tools may short across electrical circuits and cause damage to equipment, or severe burns or electrical shock to personnel.**

- Step 7. Turn battery disconnect switch to OFF position (WP 0007). Connect pump hose wire harness pump engine wire harness connector. Remove pump house panel G (WP 0540). Remove pump engine cooling shroud (WP 0248). Turn battery disconnect switch to ON position (WP 0007). While an assistant puts cab or pump operator's panel START PUMP ENGINE STOP switch to START position (WP 0022), check for 22 to 28 VDC between pump engine wire harness starter solenoid signal wire at pump engine starter solenoid, terminal to a known good ground.

If 22 to 28 VDC are not present, repair wire 4072 in pump engine wire harness if repairable (TM 9-2320-325-14&P), or replace pump engine wire harness (WP 0464).

---

**MALFUNCTION****TEST OR INSPECTION****CORRECTIVE ACTION**

---

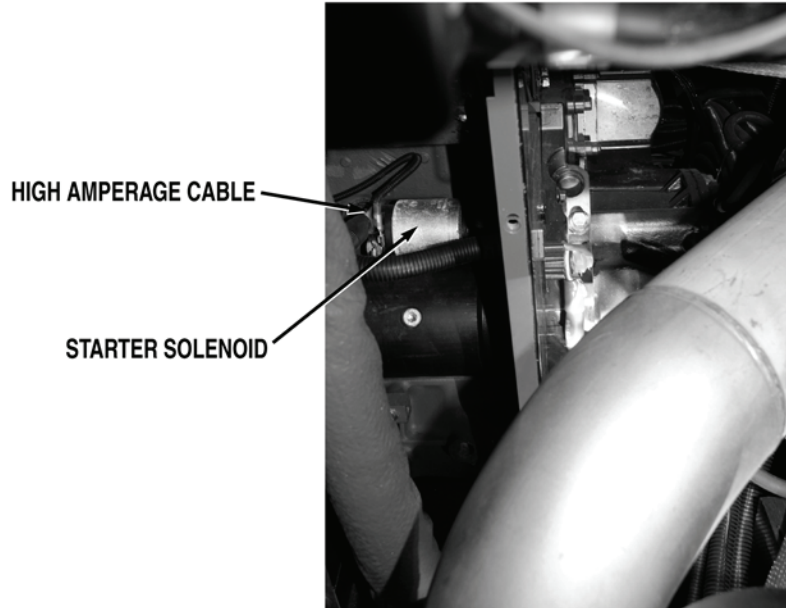
**WARNING**

**Remove rings, wristwatches, neck chains, and any other jewelry before working around vehicle. Jewelry can catch on equipment and cause serious injury. Jewelry and tools may short across electrical circuits and cause damage to equipment, or severe burns or electrical shock to personnel.**

- Step 8. Check for 22 to 28 VDC between high amperage cable at pump engine starter solenoid to a known good ground.

If 22 to 28 VDC are not present, go to Step 11.

---

**MALFUNCTION****TEST OR INSPECTION****CORRECTIVE ACTION**

---

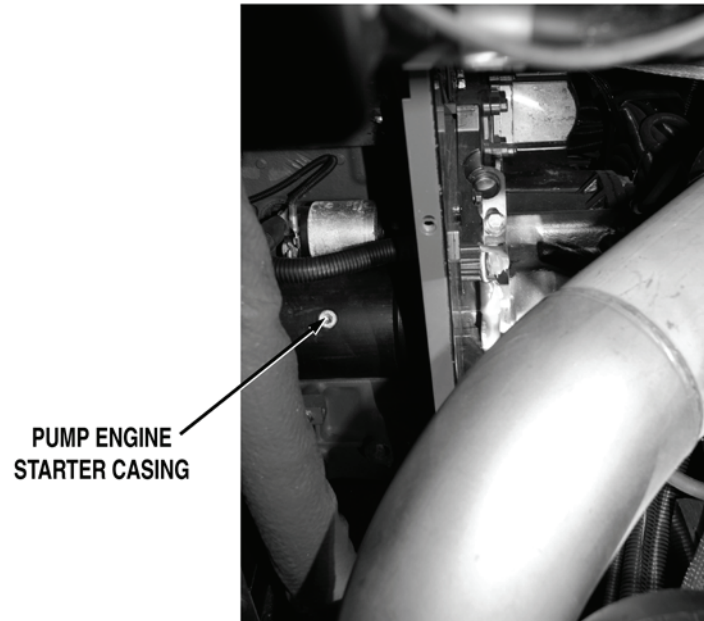
**NOTE**

It is mandatory to choose a ground on vehicle chassis for checking continuity in Step 9. Using a ground on pump engine may give a false continuity reading and will not ensure that pump engine is properly grounded.

- Step 9. Turn battery disconnect switch to OFF position (WP 0007). Check for continuity across pump engine ground from pump engine starter casing to a known good ground.

If there is continuity, replace pump engine starter (WP 0248).

- Step 10. With a torque wrench, tighten starter bolts to 35 lb-ft (48 N•m). Check for continuity across pump engine ground from pump engine starter casing to a known good ground.

- a. If there is continuity, fault corrected.
- b. If there is no continuity, replace pump engine ground cable (WP 0368).

---

**MALFUNCTION****TEST OR INSPECTION****CORRECTIVE ACTION**

---

PASS THROUGH  
TERMINAL BLOCK

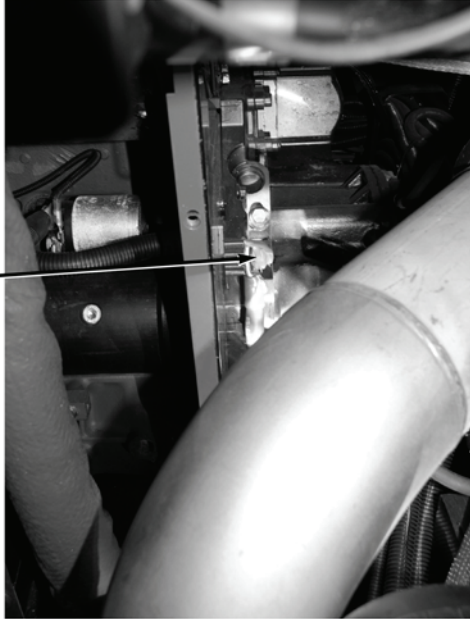
**WARNING**

**Remove rings, wristwatches, neck chains, and any other jewelry before working around vehicle. Jewelry can catch on equipment and cause serious injury. Jewelry and tools may short across electrical circuits and cause damage to equipment, or severe burns or electrical shock to personnel.**

- Step 11. Check for 22 to 28 VDC between high amperage cable at pass-through terminal block to a known good ground.
- a. If 22 to 28 VDC are present, replace pump engine starter high amperage cable and pass-through terminal block (WP 0368).
  - b. If 22 to 28 VDC are not present, replace high amperage cable from pass-through terminal block to chassis terminal block (WP 0368).

## MALFUNCTION

## TEST OR INSPECTION

## CORRECTIVE ACTION

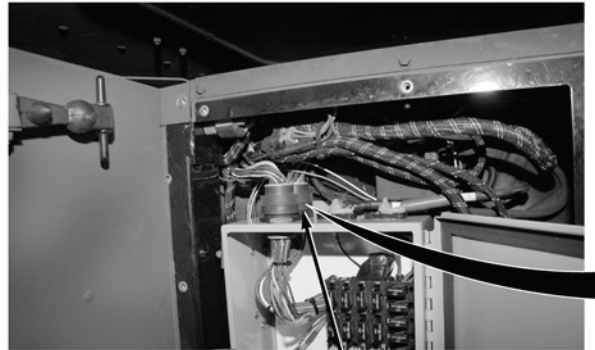

PUMP OPERATOR'S PANEL WIRE  
HARNESS PUMP HOUSE POWER  
DISTRIBUTION WIRE HARNESS  
CONNECTOR DP2

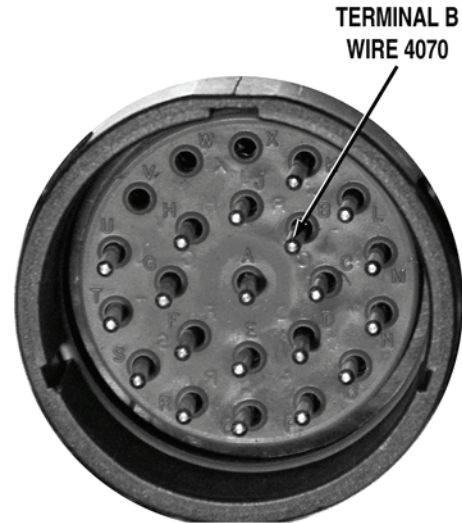
**WARNING**

Remove rings, wristwatches, neck chains, and any other jewelry before working around vehicle. Jewelry can catch on equipment and cause serious injury. Jewelry and tools may short across electrical circuits and cause damage to equipment, or severe burns or electrical shock to personnel.

- Step 12. Turn battery disconnect switch to OFF position (WP 0007). Disconnect pump operator's panel wire harness pump house power distribution wire harness connector DP2. Turn battery disconnect switch to ON position (WP 0007). With a test lead set, check for 22 to 28 VDC between pump house power distribution wire harness wire 4070 (white) from pump operator's panel wire harness pump house power distribution wire harness connector DP2, terminal B to a known good ground.
- a. If 22 to 28 VDC are present, repair wire 4070 in pump operator's panel wire harness if repairable (TM 9-2320-325-14&P), or replace pump operator's panel wire harness (WP 0459).
  - b. If 22 to 28 VDC are not present, repair wire 4070 in pump house power distribution wire harness if repairable (TM 9-2320-325-14&P), or replace pump house distribution wire harness and block (WP 0457).

END OF TASK

**FOLLOW-ON MAINTENANCE**

Remove wheel chocks (TM 9-2320-347-10)

**END OF TASK**

**END OF WORK PACKAGE**



**FIELD LEVEL MAINTENANCE**

**WATER PUMP ENGINE FAILS TO CRANK FROM PERSONNEL CAB**

**INITIAL SETUP:**

**Tools and Special Tools**

Lead Set, Test (WP 0622, Item 21)  
 Tool Kit, General Mechanic's: Automotive  
 (WP 0622, Item 27)

**Personnel Required**

MOS 63B Wheeled vehicle mechanic (2)

**References**

TM 9-2320-325-14&P  
 WP 0004  
 WP 0007  
 WP 0019  
 WP 0074  
 WP 0311

**References (continued)**

WP 0315  
 WP 0443  
 WP 0455  
 WP 0459  
 WP 0499  
 WP 0540  
 WP 0550

**Equipment Conditions**

Water pump engine OFF (WP 0022)  
 Engine OFF (TM 9-2320-347-10)  
 Wheels chocked (TM 9-2320-347-10)

**MALFUNCTION**

**TEST OR INSPECTION**

**CORRECTIVE ACTION**

**WATER PUMP ENGINE FAILS TO CRANK FROM PERSONNEL CAB**

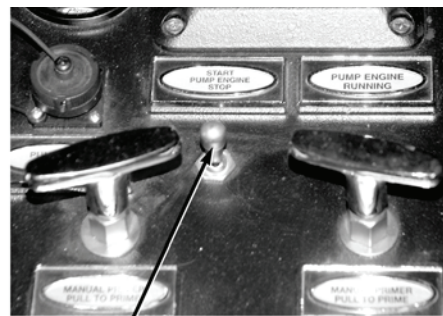
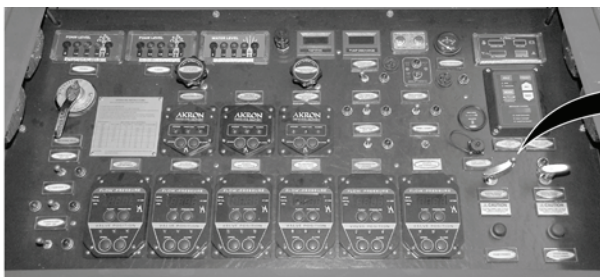

**START PUMP ENGINE STOP SWITCH**

Step 1. Turn battery disconnect switch to ON position (WP 0004). Open pump operator's panel (WP 0019). Put pump operator's panel START PUMP ENGINE STOP switch to START position (WP 0004). Check if water pump engine cranks from pump operator's panel.

If water pump engine does not crank from pump operator's panel, troubleshoot Water Pump Engine Fails To Crank From Personnel Cab and Pump Operator's Panel (WP 0074).

**MALFUNCTION**

**TEST OR INSPECTION**

**CORRECTIVE ACTION**

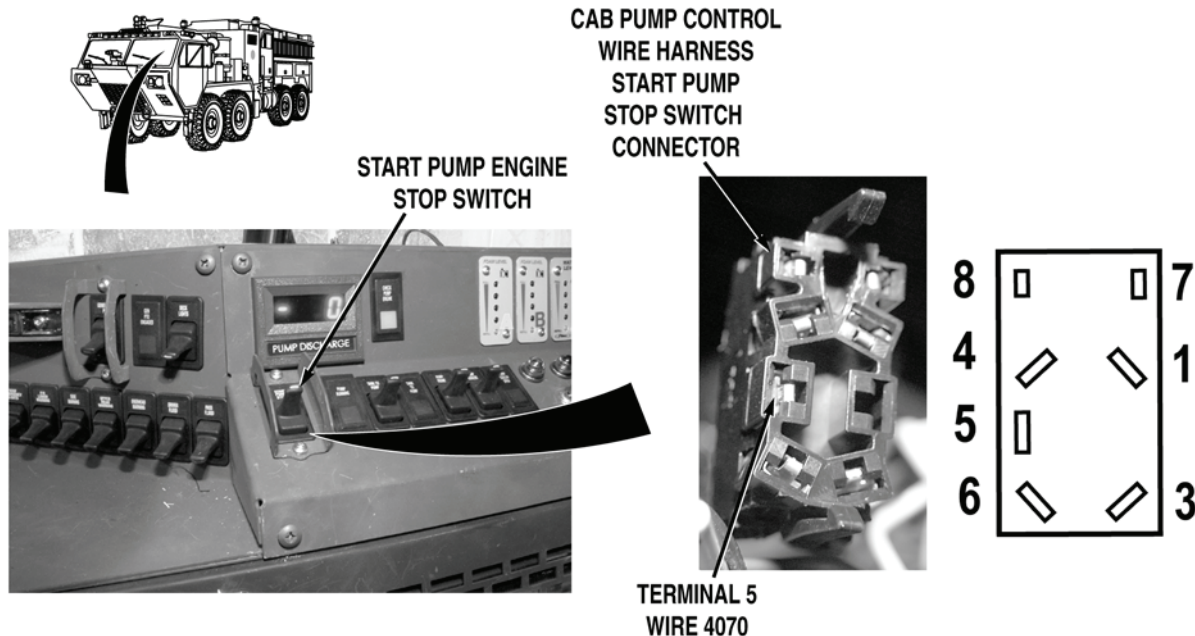

**WARNING**



Remove rings, wristwatches, neck chains, and any other jewelry before working around vehicle. Jewelry can catch on equipment and cause serious injury. Jewelry and tools may short across electrical circuits and cause damage to equipment, or severe burns or electrical shock to personnel.

Step 2. Turn battery disconnect switch to OFF position (WP 0007). Remove cab instrument panel B (WP 0311). Disconnect cab pump control wire harness START PUMP STOP switch connector. Turn battery disconnect switch to ON position (WP 0007). Check for 22 to 28 VDC between wire 4070 (white) from cab pump control wire harness START PUMP STOP switch connector, terminal 5 to a known good ground.

If 22 to 28 VDC are not present, go to Step 5.

**MALFUNCTION**

**TEST OR INSPECTION**

**CORRECTIVE ACTION**

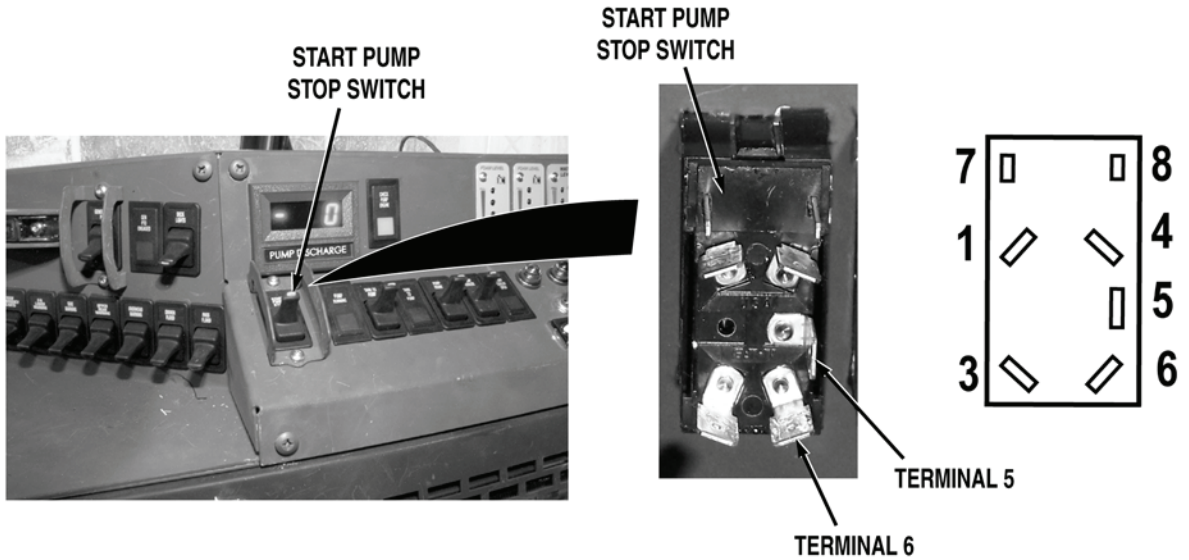

Step 3. Turn battery disconnect switch to OFF position (WP 0004). While an assistant holds START PUMP STOP switch in START position (WP 0022), check for continuity across START PUMP STOP switch, from terminal 5 to terminal 6.

If there is no continuity, replace cab START PUMP STOP switch (WP 0315).

## MALFUNCTION

## TEST OR INSPECTION

## CORRECTIVE ACTION

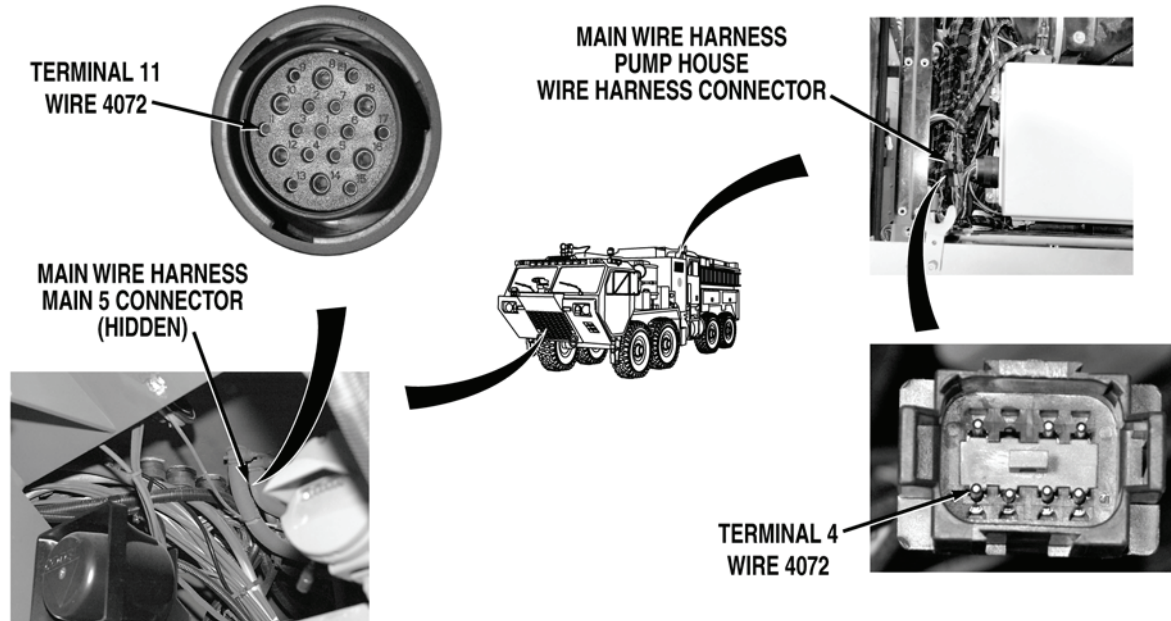

- Step 4. Remove skid plate grille (WP 0550). Disconnect main wire harness main 5 connector. Disconnect main wire harness pump house wire harness connector. With a test lead set, check for continuity across main wire harness wire 4072 (green) from main wire harness main 5 connector, terminal 11 to main wire harness pump house wire harness connector, terminal 4.
- a. If there is continuity, repair wire 4072 in cab pump control wire harness if repairable (TM 9-2320-325-14&P), or replace cab pump control wire harness (WP 0443).
  - b. If there is no continuity, repair wire 4072 in main wire harness if repairable (TM 9-2320-325-14&P), or replace main wire harness (WP 0455).

---

<b>MALFUNCTION</b>		
<b>TEST OR INSPECTION</b>		
	<b>CORRECTIVE ACTION</b>	

---

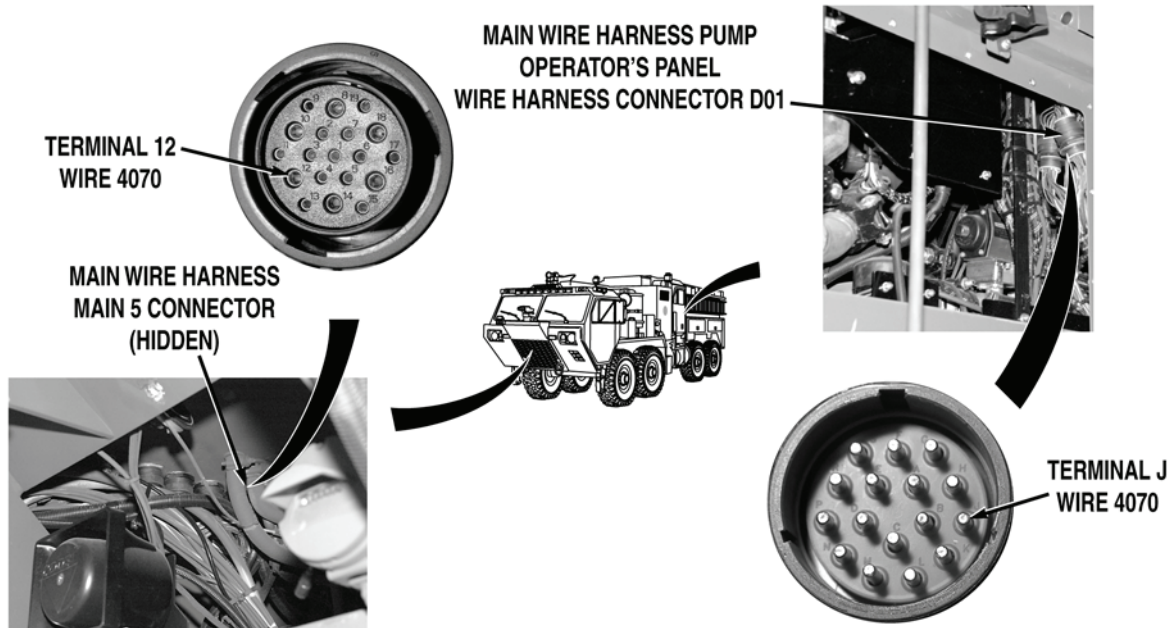

- Step 5. Turn battery disconnect switch to OFF position (WP 0007). Remove skid plate grille (WP 0550). Disconnect main wire harness main 5 connector. Remove driver side crew cab access panel (WP 0499). Remove pump house panel Q (WP 0540). Disconnect main wire harness pump operator's panel wire harness connector DO1. With a test lead set, check for continuity across main wire harness wire 4070 (white) from main wire harness main 5 connector, terminal 12 to main wire harness pump operator's panel wire harness connector DO1, terminal J.

If there is no continuity, repair wire 4070 in main wire harness if repairable (TM 9-2320-325-14&P), or replace main wire harness (WP 0455).

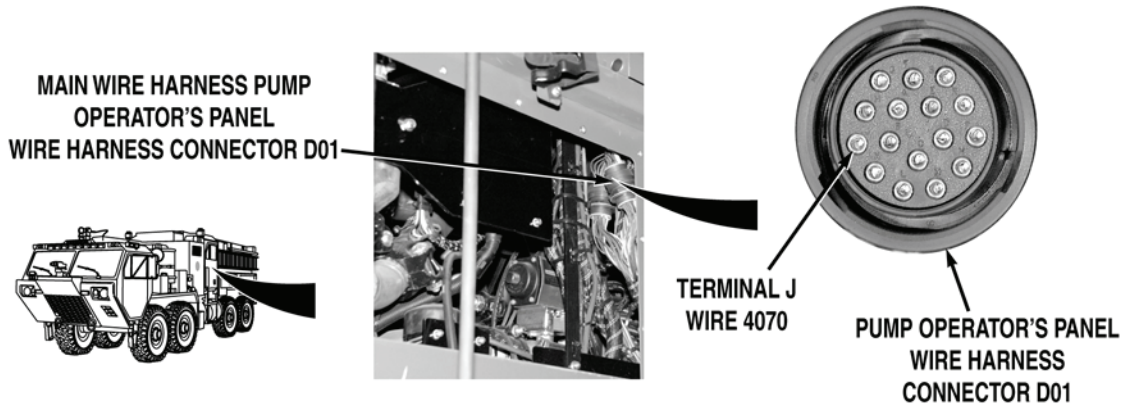
**MALFUNCTION****TEST OR INSPECTION****CORRECTIVE ACTION****WARNING**

**Remove rings, wristwatches, neck chains, and any other jewelry before working around vehicle. Jewelry can catch on equipment and cause serious injury. Jewelry and tools may short across electrical circuits and cause damage to equipment, or severe burns or electrical shock to personnel.**

- Step 6. Turn battery disconnect switch to ON position (WP 0007). With a test lead set, check for 22 to 28 VDC between pump operator's panel wire harness wire 4070 (white) from pump operator's panel wire harness connector DO1, terminal J to a known good ground.
- a. If 22 to 28 VDC are present, repair wire 4070 in cab pump control wire harness if repairable (TM 9-2320-325-14&P), or replace cab pump control wire harness (WP 0443).
  - b. If 22 to 28 VDC are not present, repair wire 4070 in pump operator's panel wire harness if repairable (TM 9-2320-325-14&P), or replace pump operator's panel wire harness (WP 0459).

**END OF TASK**

**FOLLOW-ON MAINTENANCE**

1. Install cab instrument panel B (WP 0311)
2. Install skid plate grille (WP 0550)
3. Remove wheel chocks (TM 9-2320-347-10)

**END OF TASK****END OF WORK PACKAGE**





**FIELD LEVEL MAINTENANCE**

**WATER PUMP ENGINE FAILS TO CRANK FROM PUMP OPERATOR'S PANEL**

**INITIAL SETUP:**

**Tools and Special Tools**

Lead Set, Test (WP 0622, Item 21)  
 Tool Kit, General Mechanic's: Automotive  
 (WP 0622, Item 27)

**References**

TM 9-2320-325-14&P  
 WP 0004  
 WP 0007  
 WP 0019  
 WP 0074  
 WP 0325

**References (continued)**

WP 0330  
 WP 0455  
 WP 0459  
 WP 0499  
 WP 0540

**Equipment Conditions**

Water pump engine OFF (WP 0022)  
 Engine OFF (TM 9-2320-347-10)  
 Wheels chocked (TM 9-2320-347-10)

**MALFUNCTION**

**TEST OR INSPECTION**

**CORRECTIVE ACTION**

**WATER PUMP ENGINE FAILS TO CRANK FROM PUMP OPERATOR'S PANEL**

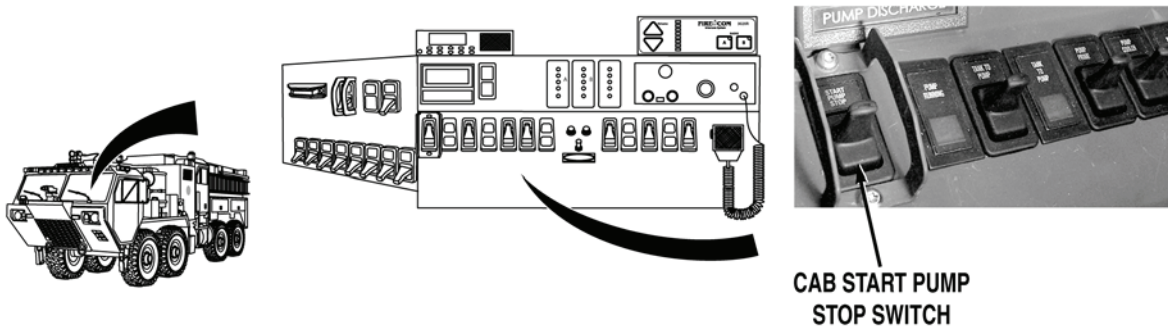

** CAUTION**

**Water pump must be primed when operating water pump engine. Failure to prime water pump when operating water pump engine will cause damage to equipment.**

- Step 1. Turn battery disconnect switch to ON position (WP 0007). Put cab START PUMP STOP switch to START POSITION (WP 0004). Check if pump engine cranks from cab position.

If pump engine does not start from cab position, troubleshoot Water Pump Engine Fails To Crank From Personnel Cab and Pump Operator's Panel (WP 0074).

## MALFUNCTION

## TEST OR INSPECTION

## CORRECTIVE ACTION



START PUMP  
ENGINE STOP  
SWITCH

**WARNING**

Remove rings, wristwatches, neck chains, and any other jewelry before working around vehicle. Jewelry can catch on equipment and cause serious injury. Jewelry and tools may short across electrical circuits and cause damage to equipment, or severe burns or electrical shock to personnel.

- Step 2. Turn battery disconnect switch to OFF position (WP 0007). Open pump operator's panel housing (WP 0325). Turn battery disconnect switch to ON position (WP 0007). Check for 22 to 28 VDC across pump operator's panel wire harness wire 4070 (white) from pump operator's panel wire harness START PUMP ENGINE STOP switch, terminal to a known good ground.

If 22 to 28 VDC are not present, repair wire 4070 in pump operator's panel wire harness if repairable (TM 9-2320-325-14&P), or replace pump operator's panel wire harness (WP 0459).

---

**MALFUNCTION**  
**TEST OR INSPECTION**  
**CORRECTIVE ACTION**

---

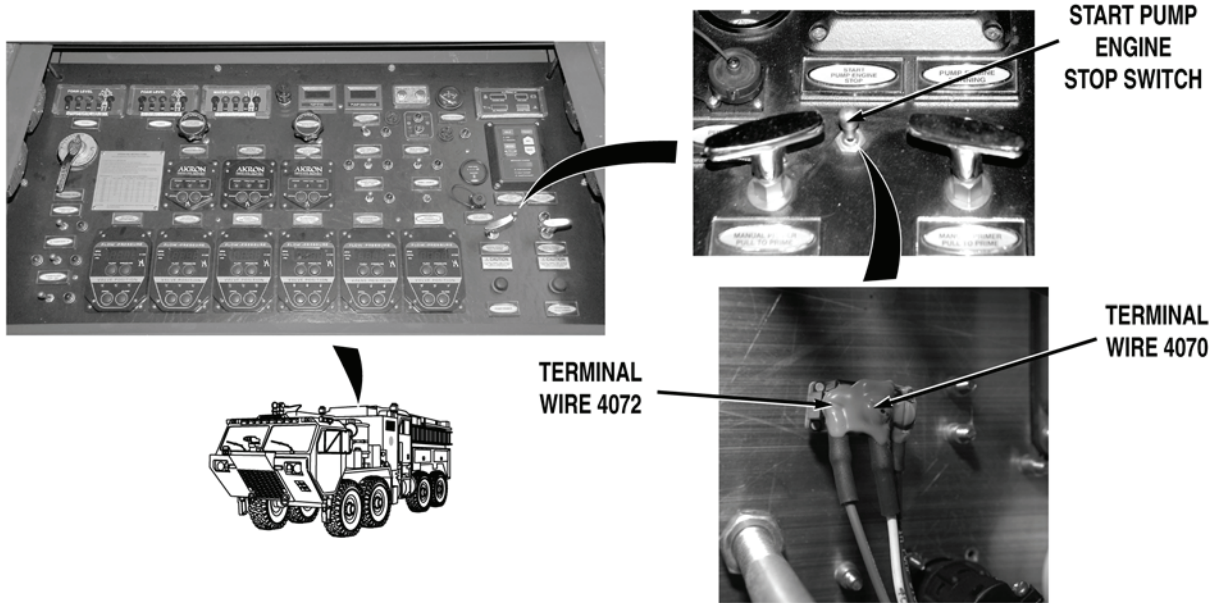

- Step 3. Turn battery disconnect switch to OFF position (WP 0007). Open pump operator's panel (WP 0019). While an assistant puts pump operator's panel START PUMP ENGINE STOP switch to START position (WP 0004), check for continuity across pump operator's panel START PUMP ENGINE STOP switch from terminal wire 4072 (green) to terminal wire 4070 (white).

If there is no continuity, replace pump operator's panel START PUMP ENGINE STOP switch (WP 0330).

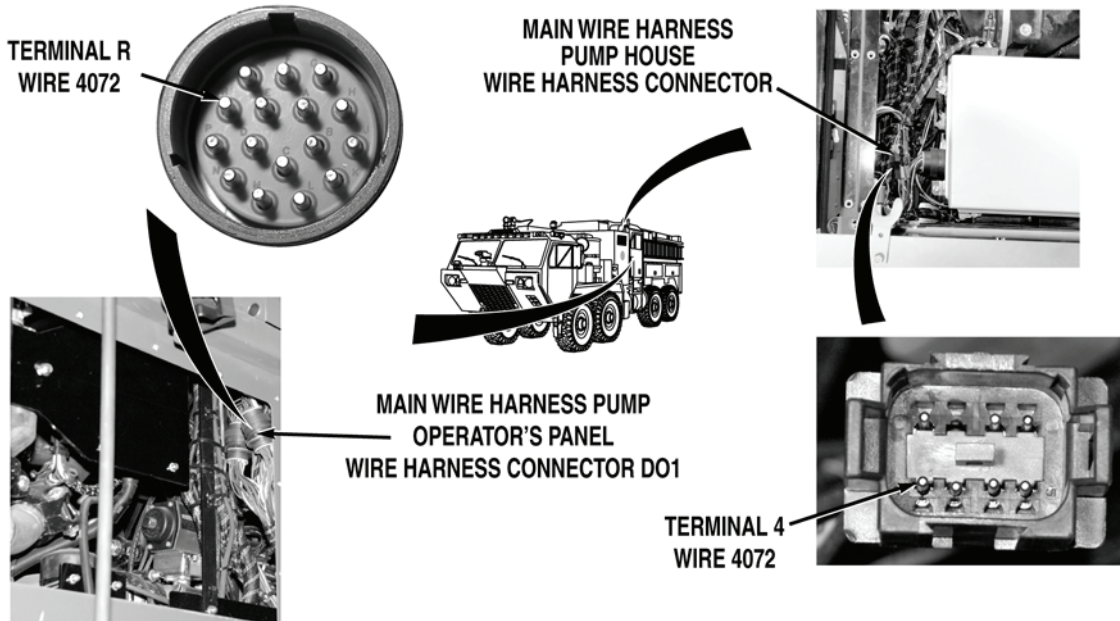
**MALFUNCTION****TEST OR INSPECTION****CORRECTIVE ACTION**

- Step 4. Remove driver side crew cab access panel (WP 0499). Remove pump house panel Q (WP 0540). Disconnect main wire harness pump operator's panel wire harness connector DO1. Remove pump house panel S (WP 0540). Disconnect main wire harness pump house wire harness connector. With a test lead set, check for continuity across main wire harness wire 4072 (green) from main wire harness pump operator's panel wire harness, connector DO1, terminal R to main wire harness pump house wire harness connector, terminal 4.
- a. If there is continuity, repair wire 4072 (green) in pump operator's panel wire harness if repairable (TM 9-2320-325-14&P), or replace pump operator's panel wire harness (WP 0459).
  - b. If there is no continuity, repair wire 4072 (green) in main wire harness if repairable (TM 9-2320-325-14&P), or replace main wire harness (WP 0455).

**END OF TASK****FOLLOW-ON MAINTENANCE**

Remove wheel chocks (TM 9-2320-347-10)

**END OF TASK****END OF WORK PACKAGE**

**FIELD LEVEL MAINTENANCE**

**WATER PUMP ENGINE PRESSURE GOVERNOR CONTROL PANEL DOES NOT CHANGE ENGINE SPEED**

**INITIAL SETUP:**

**Tools and Special Tools**

- Lead Set, Test (WP 0622, Item 21)
- Tool Kit, General Mechanic's: Automotive (WP 0622, Item 27)

**Personnel Required**

- MOS 63B Wheeled vehicle mechanic (2)

**References**

- TM 9-2320-325-14&P
- WP 0004
- WP 0007
- WP 0022
- WP 0024
- WP 0147

**References (continued)**

- WP 0226
- WP 0309
- WP 0311
- WP 0325
- WP 0332
- WP 0386
- WP 0455
- WP 0459
- WP 0539

**Equipment Conditions**

- Water pump engine OFF (WP 0022)
- Engine OFF (TM 9-2320-347-10)
- Wheels chocked (TM 9-2320-347-10)

**MALFUNCTION**

**TEST OR INSPECTION**

**CORRECTIVE ACTION**

**WATER PUMP ENGINE PRESSURE GOVERNOR CONTROL PANEL DOES NOT CHANGE ENGINE SPEED**

- Step 1. Start water pump engine (WP 0022). Check if THROTTLE READY and PUMP ENGAGED LEDs illuminate on both personnel cab and pump operator's panel pressure governors (WP 0004).
  - If THROTTLE READY and PUMP ENGAGED LEDs do not illuminate (WP 0004), troubleshoot Water Pump Engine Pressure Governor Control Panel Throttle Ready and/or Pump Engage LEDs Do Not Illuminate (WP 0147).
- Step 2. Operate personnel cab pressure governor in RPM mode (WP 0024). Check if personnel cab pressure governor changes water pump engine speed when operated (WP 0024).
  - If personnel cab pressure governor does not operate in RPM mode (WP 0024), go to Step 6.
- Step 3. Operate pump operator's panel governor in RPM mode (WP 0024). Check if pump operator's panel pressure governor changes water pump engine speed when operated (WP 0024).
  - If pump operator's panel governor operates in RPM mode (WP 0024), fault corrected.

**MALFUNCTION**

**TEST OR INSPECTION**

**CORRECTIVE ACTION**

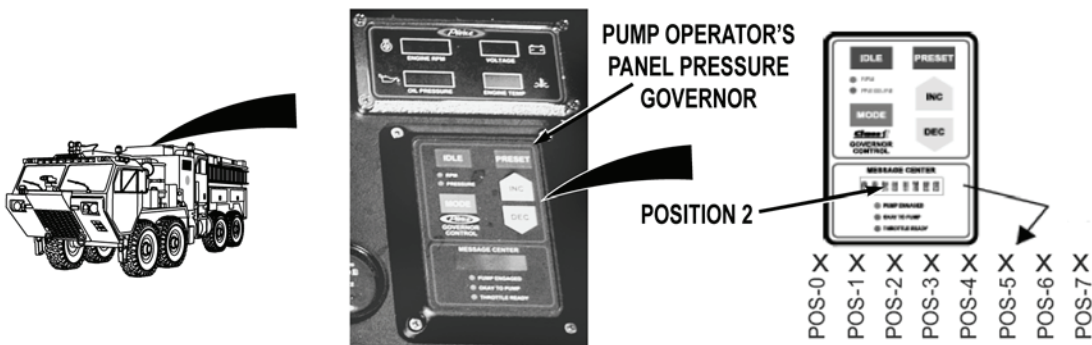

**NOTE**

The message center must display MODE on pump operator's panel governor control panel, before entering the password. Message center will display xxx3-5xx after entering self-test password.

- Step 4. Perform pressure governor self-test on pump operator's panel pressure governor by entering self-test password IDLE INC IDLE INC IDLE INC IDLE INC. Press each key on pressure governor, watch message display for a letter indicating which switch is being pressed. Once all switches, on pump operator's panel pressure governor are pressed, a "2" will be displayed in position 2.

If a letter is displayed constantly, letter is not displayed when pressed, or "2" is not displayed in position 2, replace pump operator's panel pressure governor panel (WP 0332).

## MALFUNCTION

## TEST OR INSPECTION

## CORRECTIVE ACTION

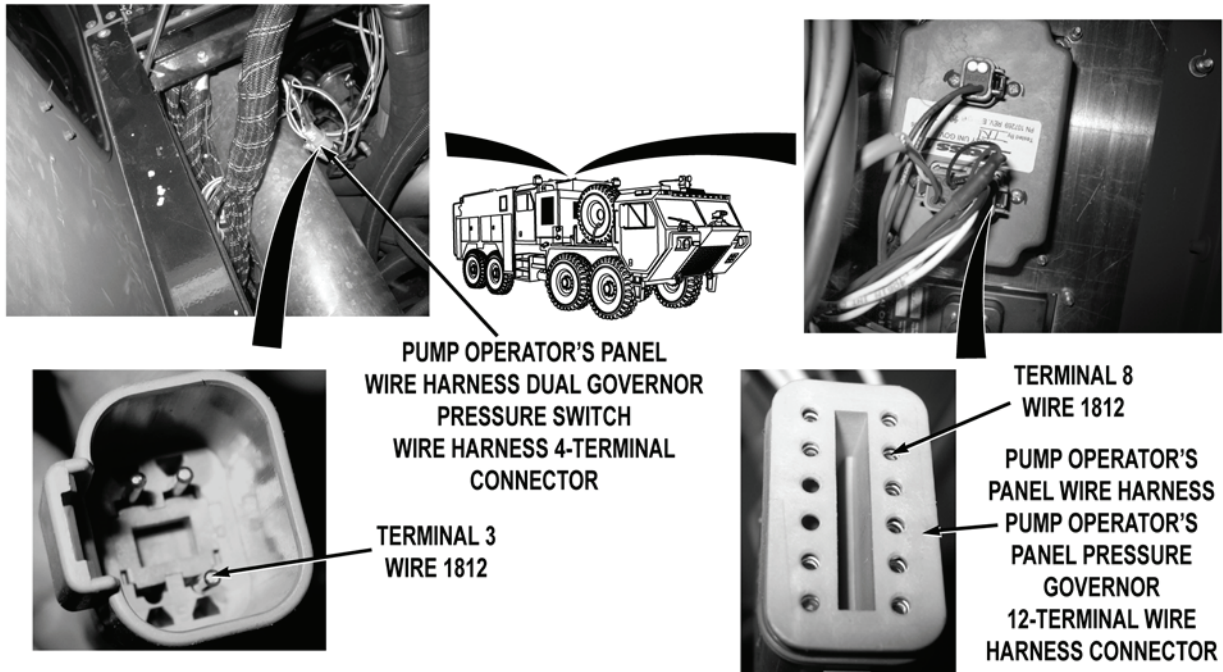
**WARNING**

Remove rings, wristwatches, neck chains, and any other jewelry before working around vehicle. Jewelry can catch on equipment and cause serious injury. Jewelry and tools may short across electrical circuits and cause damage to equipment, or severe burns or electrical shock to personnel.

- Step 5. Turn water pump engine to off (WP 0022). Turn battery disconnect switch to OFF position (WP 0007). Open pump operator's panel housing (WP 0325). Disconnect pump operator's panel wire harness pump operator's panel pressure governor 12-terminal wire harness connector. Disconnect pump operator's panel wire harness dual governor pressure switch wire harness 4-terminal connector. With a test lead set, check for continuity across wire 1812 in pump operator's panel wire harness from pump operator's panel pressure governor wire harness 12-terminal connector, terminal 8 to dual governor pressure switch wire harness 4-terminal connector, terminal 3.
- a. If continuity is present, replace dual governor pressure switch (WP 0386).
  - b. If continuity is not present, repair wire 1812 in pump operator's panel wire harness if repairable (TM 9-2320-325-14&P), or replace pump operator's panel wire harness (WP 0459).

**MALFUNCTION**

**TEST OR INSPECTION**

**CORRECTIVE ACTION**

Step 6. Operate personnel cab pressure governor in RPM mode (WP 0024). Check if pump operator's panel pressure governor changes water pump engine speed when operated (WP 0024).

If personnel cab pressure governor does not operate (WP 0024), go to Step 9

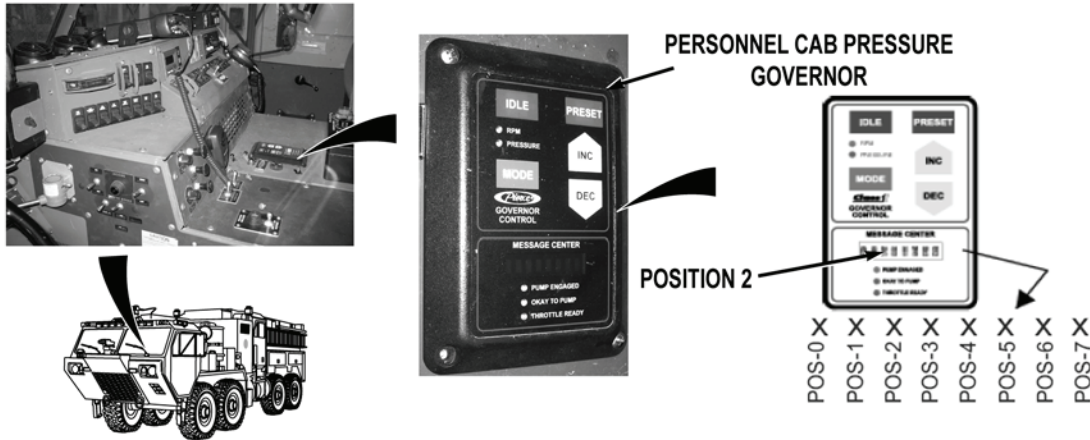

**NOTE**

The message center must display MODE on personnel cab governor control panel, before entering the password. Message center will display xxx3-5xx after entering self-test password.

Step 7. Perform pressure governor self-test on personnel cab pressure governor by entering self-test password IDLE INC IDLE INC IDLE INC IDLE INC. Press each key on personnel cab pressure governor, watch message display for a letter indicating which switch is being pressed. Once all switches, on personnel cab pressure governor are pressed, a "2" will be displayed in position 2.

If a letter is displayed constantly, letter is not displayed when pressed, or "2" is not displayed in position 2, replace personnel cab governor control panel (WP 0309).

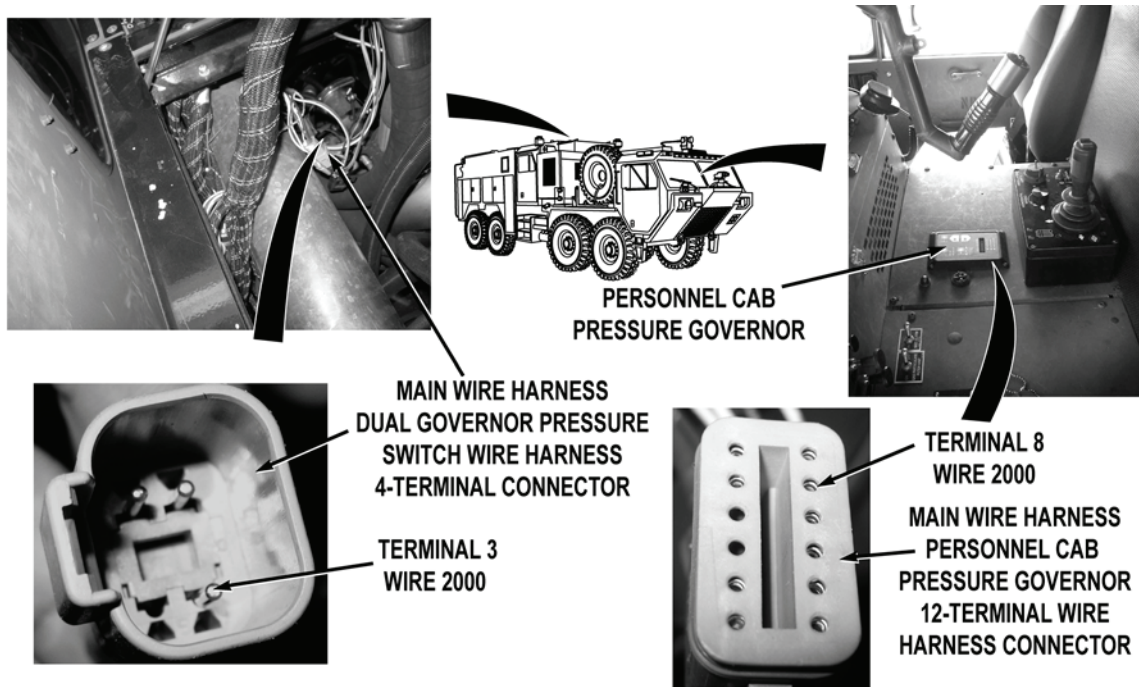

**MALFUNCTION****TEST OR INSPECTION****CORRECTIVE ACTION****WARNING**

**Remove rings, wristwatches, neck chains, and any other jewelry before working around vehicle. Jewelry can catch on equipment and cause serious injury. Jewelry and tools may short across electrical circuits and cause damage to equipment, or severe burns or electrical shock to personnel.**

- Step 8. Turn water pump engine to off (WP 0022). Turn battery disconnect switch to OFF position (WP 0007). Remove cab instrument panel E (WP 0311). Disconnect main wire harness personnel cab pressure governor 12-terminal wire harness connector from personnel cab pressure governor. Open pump operator's panel housing (WP 0325). Disconnect main wire harness dual governor pressure switch wire harness 4-terminal connector. With a test lead set, check for continuity across wire 2000 in main wire harness from personnel cab pressure governor 12-terminal wire harness connector, terminal 8 to dual governor pressure switch wire harness 4-terminal connector, terminal 3.
- a. If continuity is present, replace dual governor pressure switch (WP 0386).
  - b. If continuity is not present, repair wire 2000 in main wire harness if repairable (TM 9-2320-325-14&P), or replace main wire harness (WP 0455).

**MALFUNCTION**

**TEST OR INSPECTION**

**CORRECTIVE ACTION**

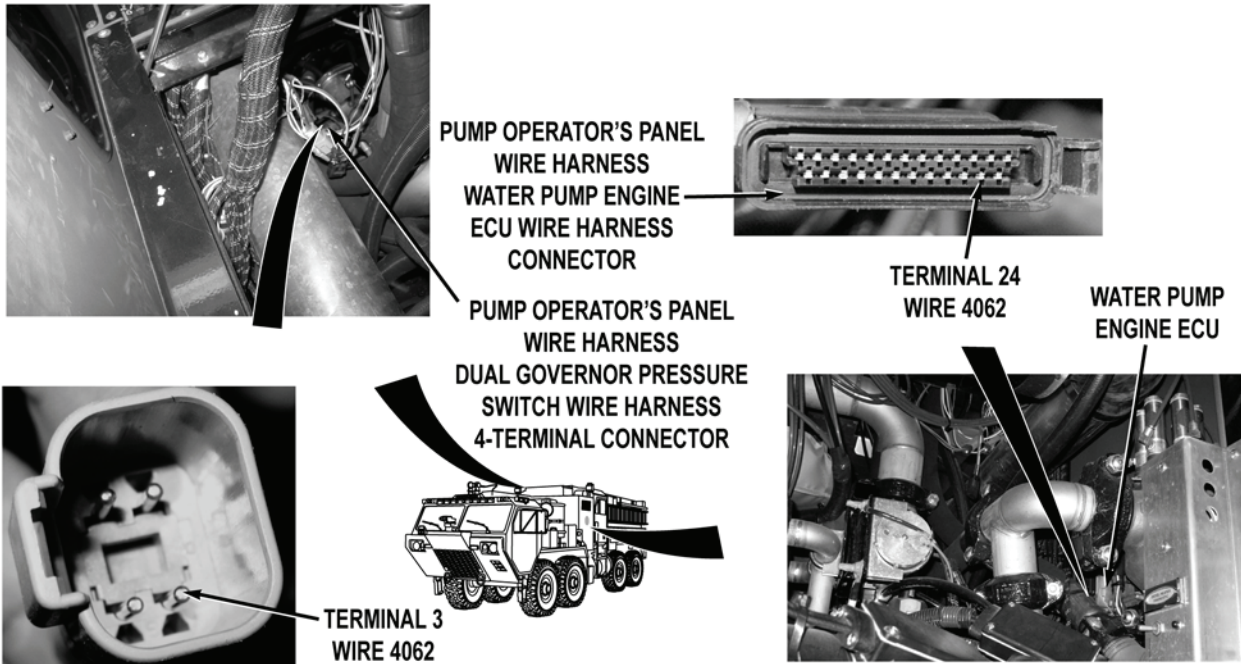

Step 9. Turn water pump engine off (WP 0022). Turn battery disconnect switch to OFF position (WP 0007). Open pump house panel A (WP 0539). Open pump operator's panel housing (WP 0325). Disconnect pump operator's panel wire harness water pump engine ECU wire harness connector from water pump engine ECU. Open pump operator's panel housing (WP 0325). Disconnect pump operator's panel wire harness dual governor pressure switch wire harness 4-terminal connector. With a test lead set, check for continuity across wire 4062 in pump operator's panel wire harness from water pump engine ECU wire harness connector, terminal 24 to dual governor pressure switch wire harness 4-terminal connector, terminal 3.

If continuity is not present, repair wire 4062 in pump operator's panel wire harness if repairable (TM 9-2320-325-14&P), or replace pump operator's panel wire harness (WP 0459).

---

**MALFUNCTION**  
**TEST OR INSPECTION**  
**CORRECTIVE ACTION**

---

PUMP OPERATOR'S  
 PANEL PRESSURE  
 GOVERNOR  
 12-TERMINAL  
 WIRE HARNESS  
 CONNECTOR

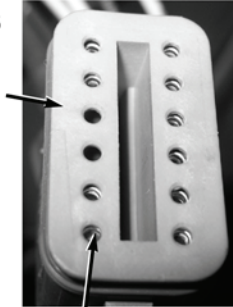

TERMINAL 1  
 WIRE 1966



WATER PUMP  
 ENGINE ECU

PUMP OPERATOR'S PANEL  
 WIRE HARNESS  
 WATER PUMP ENGINE  
 ECU WIRE HARNESS  
 CONNECTOR

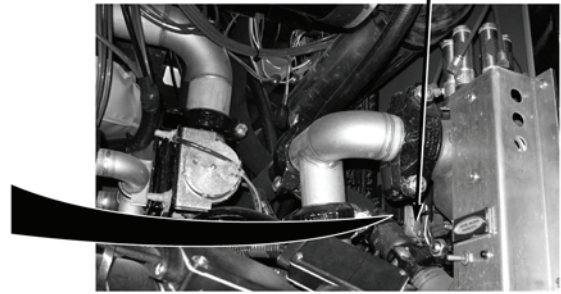

- Step 10. Reconnect pump operator's panel wire harness water pump engine ECU wire harness connector to water pump engine ECU. Disconnect pump operator's panel wire harness pressure governor 12-terminal wire harness connector. Turn battery disconnect switch to ON position (WP 0007). Start water pump engine (WP 0022). With a test lead set, check for 5 VDC at wire 1966 from pressure governor 12-terminal wire harness connector, terminal 1 to a known good ground.

If 5 VDC are not present, replace water pump engine electronic control unit (WP 0226).

---

**MALFUNCTION****TEST OR INSPECTION****CORRECTIVE ACTION**

---

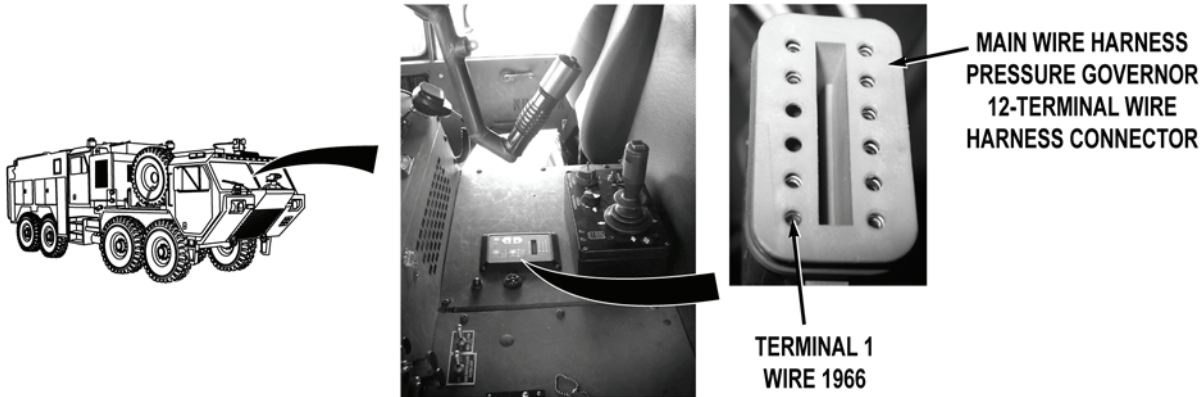

- Step 11. Remove personnel cab instrument panel E (WP 0311). Disconnect main wire harness pressure governor 12-terminal wire harness connector. Turn battery disconnect switch to ON position (WP 0007). Start water pump engine (WP 0022). With a test lead set, check for 5 VDC at wire 1966 from pressure governor wire harness 12-terminal connector, terminal 1 to a known good ground.

If 5 VDC are not present, replace water pump engine electronic control unit (WP 0226).

---

<b>MALFUNCTION</b>	
<b>TEST OR INSPECTION</b>	
	<b>CORRECTIVE ACTION</b>

---

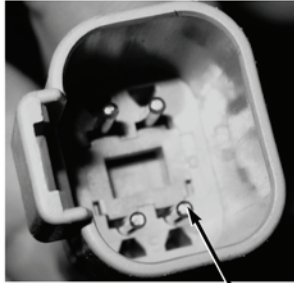

**TERMINAL 3  
WIRE 4062**

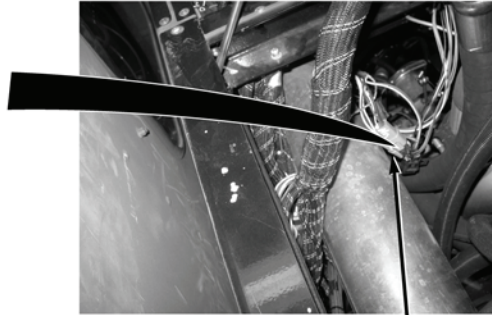

**PUMP OPERATOR'S PANEL WIRE HARNESS  
DUAL GOVERNOR PRESSURE SWITCH  
WIRE HARNESS 4-TERMINAL CONNECTOR**

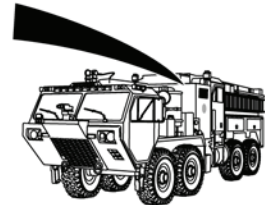

### NOTE

When INC switch is pressed voltage should increase. By pressing DEC switch, voltage should decrease.

- Step 12. Operate pump operator's panel pressure governor in RPM mode (WP 0024). Push INC or DEC switches to adjust engine speed (WP 0004). With a test lead set, check for 0.7 to 4.5 VDC on wire 4062 at pump operator's panel wire harness dual governor pressure switch wire harness 4-terminal connector, terminal 3.

If 0.7 to 4.5 VDC are not present, replace dual governor pressure switch (WP 0386).

- Step 13. Operate personnel cab pressure governor in RPM mode (WP 0024). Push INC or DEC switches to adjust engine speed (WP 0004). With a test lead set, check for 0.7 to 4.5 VDC on wire 4062 at pump operator's panel wire harness dual governor pressure switch wire harness 4-terminal connector, terminal 3.

If 0.7 to 4.5 VDC are present, replace water pump engine electronic control unit (WP 0226).

If 0.7 to 4.5 VDC are not present, replace dual governor pressure switch (WP 0386).

### END OF TASK

### FOLLOW-ON MAINTENANCE

Remove wheel chocks (TM 9-2320-347-10)

### END OF TASK

### END OF WORK PACKAGE



**FIELD LEVEL MAINTENANCE**

**WATER PUMP ENGINE PRESSURE GOVERNOR CONTROL PANEL DOES NOT CHANGE PUMP PRESSURE**

**INITIAL SETUP:**

**Tools and Special Tools**

Lead Set, Test (WP 0622, Item 21)  
 Tool Kit, General Mechanic's: Automotive  
 (WP 0622, Item 27)

**Personnel Required**

MOS 63B Wheeled vehicle mechanic (2)

**References**

WP 0004  
 WP 0007  
 WP 0022  
 WP 0024  
 WP 0077

**References (continued)**

WP 0147  
 WP 0309  
 WP 0311  
 WP 0325  
 WP 0332  
 WP 0411  
 WP 0460

**Equipment Conditions**

Water pump engine OFF (WP 0022)  
 Engine OFF (TM 9-2320-347-10)  
 Wheels chocked (TM 9-2320-347-10)

**MALFUNCTION**

**TEST OR INSPECTION**

**CORRECTIVE ACTION**

**WATER PUMP ENGINE PRESSURE GOVERNOR CONTROL PANEL DOES NOT CHANGE PUMP PRESSURE**

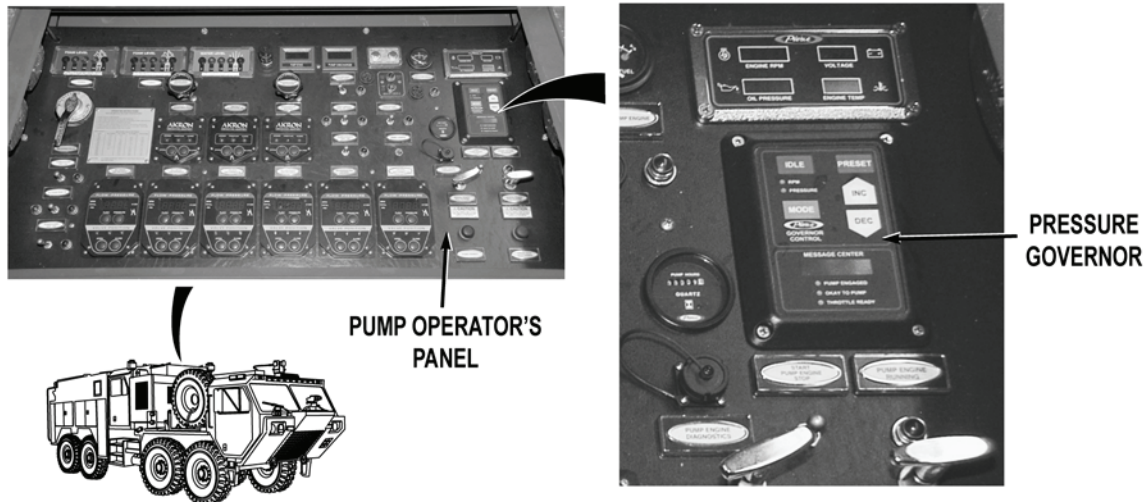

- Step 1. Start water pump engine (WP 0022). Operate pump operator's panel pressure governor (WP 0024). Check if pump pressure increases when pump operator's panel pressure governor is operated.

If pump pressure does not increase when pump operator's panel pressure governor is operated, go to Step 8.

- Step 2. Push IDLE switch on pump operator's panel pressure governor (WP 0004). Check if PUMP ENGAGED LED illuminates (WP 0004).

If PUMP ENGAGED LED does not illuminate, troubleshoot water pump engine governor control panel THROTTLE READY and /or PUMP ENGAGED LEDs do not illuminate (WP 0147).

- Step 3. Put pump operator's panel pressure governor in RPM mode (WP 0024). Check if pump operator's panel pressure governor changes water pump engine RPM.

If pump operator's panel pressure governor does not change water pump engine RPM, troubleshoot water pump engine governor control does not change engine speed (WP 0077).

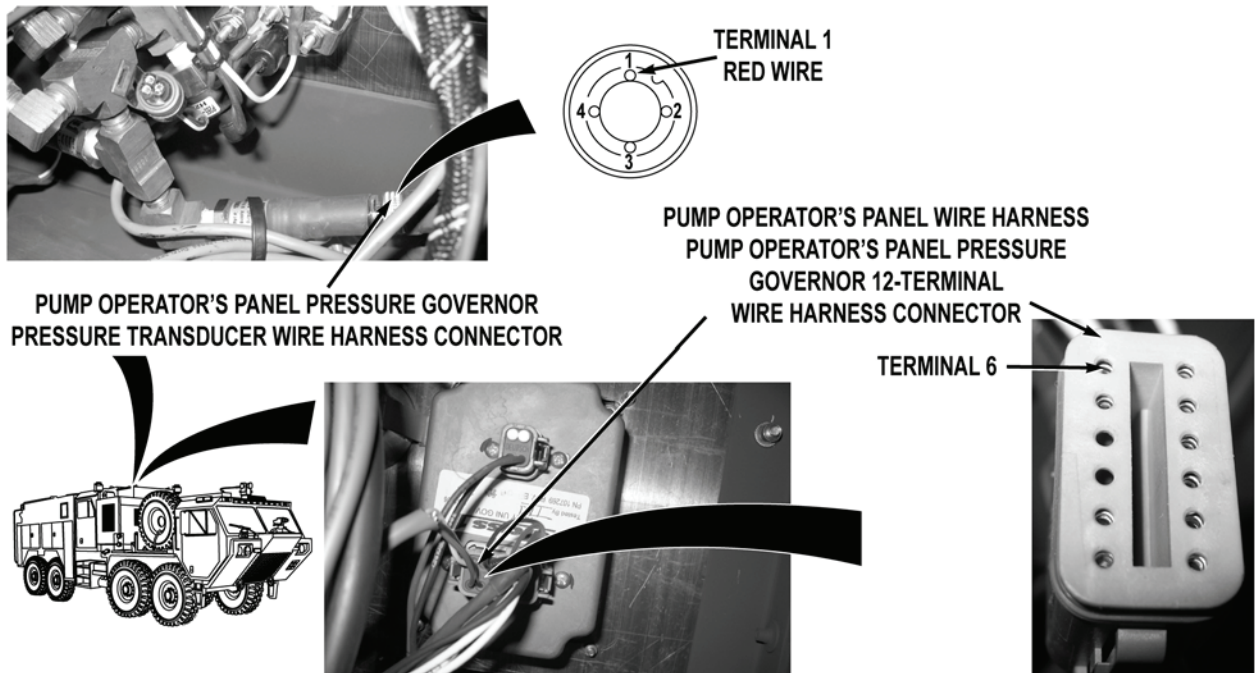

**WARNING**

Remove rings, wristwatches, neck chains, and any other jewelry before working around vehicle. Jewelry can catch on equipment and cause serious injury. Jewelry and tools may short across electrical circuits and cause damage to equipment, or severe burns or electrical shock to personnel.

**NOTE**

Sensor failure or problems due to moisture and corrosion may occur. Inspect pressure transducer and connector for damaged terminals, loose water seal wedge-lock connections, moisture, corrosion, and other foreign objects, using a bright light.

- Step 4. Turn water pump engine off (WP 0022). Turn battery disconnect switch to OFF position (WP 0007). Open pump operator's panel housing (WP 0325). Disconnect pump operator's panel wire harness pump operator's panel pressure governor 12-terminal wire harness connector. Disconnect pump operator's panel pressure governor pressure transducer wire harness connector. With a test lead set, check for continuity across red wire from pressure transducer connector, terminal 1 to pressure governor 12-terminal connector, terminal 6.

If continuity is not present, replace pressure transducer wire harness (WP 0460).

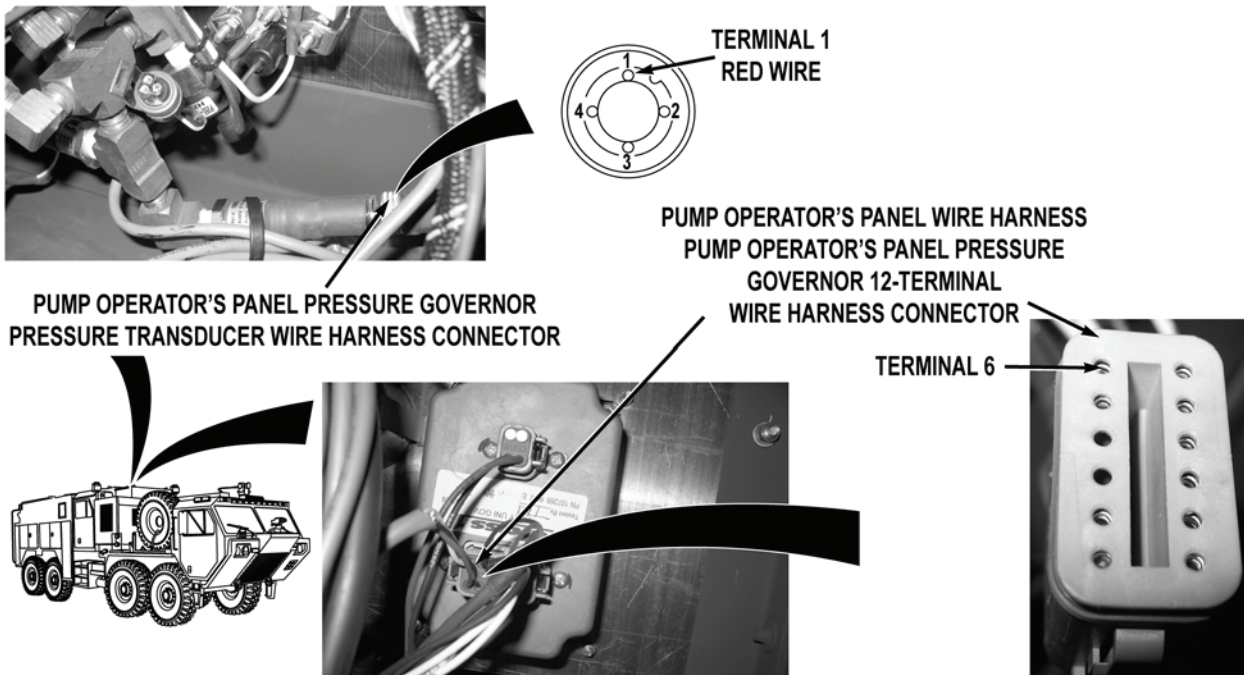

Step 5. With a test lead set, check for continuity across white wire from pressure transducer connector, terminal 3 to pressure governor 12-terminal connector, terminal 7.

If continuity is not present, replace pressure transducer wire harness (WP 0460).

Step 6. With a test lead set, check for continuity across black wire from pressure transducer connector, terminal 2 to pressure governor 12-terminal connector, terminal 5.

If continuity is not present, replace pressure transducer wire harness (WP 0460).

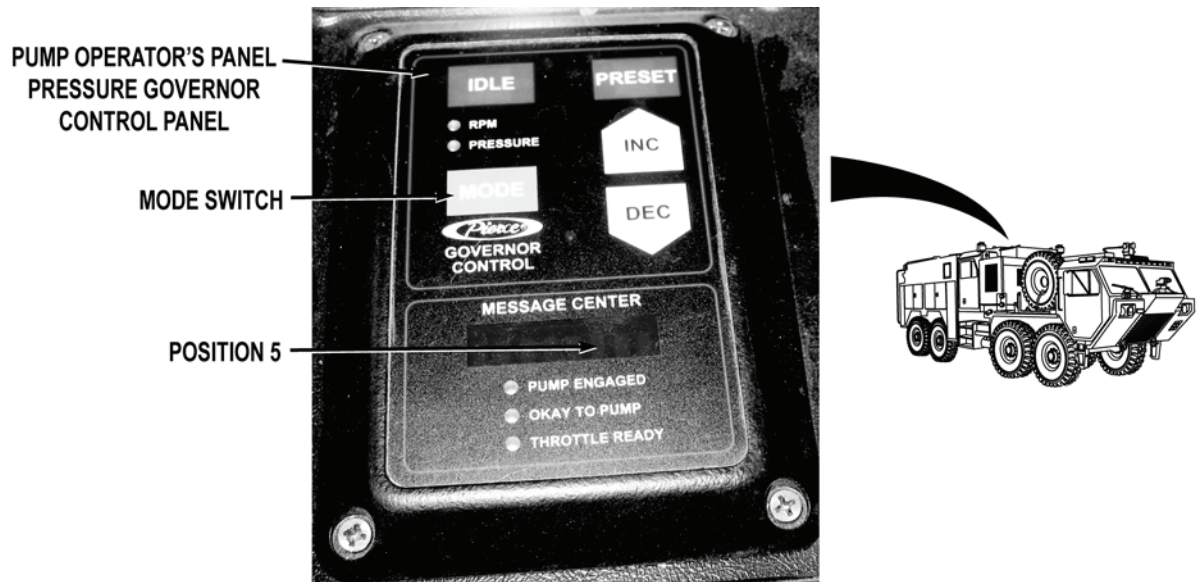

### NOTE

The message center must display MODE on pump operator's panel governor control panels, before entering the password. Message center will display xxx3-5xx after entering self-test password.

- Step 7. Reconnect pump operator's panel wire harness pump operator's panel pressure governor 12-terminal wire harness connector. Reconnect pump operator's panel pressure governor pressure transducer wire harness connector. Turn battery disconnect switch to ON position (WP 0007). Start water pump engine (WP 0022). Push MODE switch on pump operator's panel pressure governor control panel. Perform governor control panel self test on pump operator's panel governor control by entering self-test password IDLE INC IDLE INC IDLE INC IDLE INC. Check for "5", H or F in position 5 when display enters self-test mode.
- a. If pump operator's panel pressure governor displays "5" or H in position 5, replace pump operator's panel pressure governor panel (WP 0332).
  - b. If pump operator's panel governor displays F in position 5, replace pump operator's panel pressure governor pressure transducer (WP 0411).

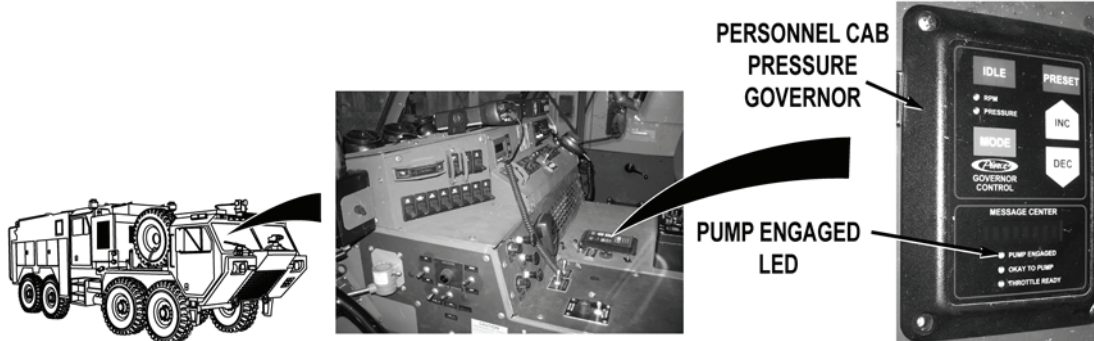

- Step 8. Operate personnel cab pressure governor (WP 0024). Check if pump pressure increases when personnel cab pressure governor is operated.

If pump pressure does not increase when personnel cab pressure governor is operated, troubleshoot water pump engine governor control panel does not change engine speed (WP 0077).

- Step 9. Push IDLE switch on personnel cab pressure governor (WP 0004). Check if PUMP ENGAGED LED illuminates (WP 0004).

If PUMP ENGAGED LED does not illuminate, troubleshoot water pump engine governor THROTTLE READY and /or PUMP ENGAGED LEDs do not illuminate (WP 0147).

- Step 10. Put personnel cab pressure governor in RPM mode (WP 0024). Check if personnel cab pressure governor changes water pump engine RPM.

If personnel cab pressure governor does not change water pump engine RPM, troubleshoot water pump engine governor control does not change engine speed (WP 0077).

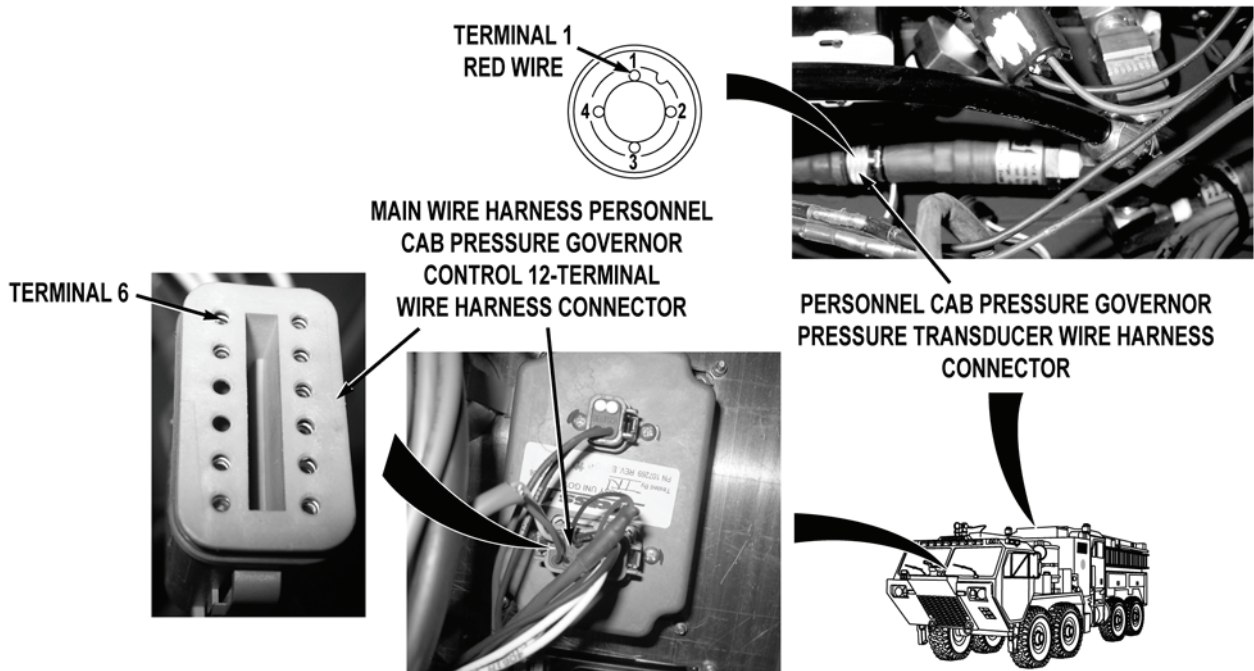
**WARNING**

Remove rings, wristwatches, neck chains, and any other jewelry before working around vehicle. Jewelry can catch on equipment and cause serious injury. Jewelry and tools may short across electrical circuits and cause damage to equipment, or severe burns or electrical shock to personnel.

**NOTE**

Sensor failure or problems due to moisture and corrosion may occur. Inspect pressure transducer and connector for damaged terminals, loose water seal wedge-lock connections, moisture, corrosion, and other foreign objects, using a bright light.

- Step 11. Turn water pump engine off (WP 0022). Open pump operator's panel housing (WP 0325). Remove cab instrument panel E (WP 0311). Turn battery disconnect switch to OFF position (WP 0007). Disconnect main wire harness personnel cab pressure governor control 12-terminal wire harness connector. Disconnect personnel cab pressure governor pressure transducer wire harness connector. With a test lead set, check for continuity across red wire from pressure transducer connector, terminal 1 to pressure governor 12-terminal connector, terminal 6.

If continuity is not present, replace pressure transducer wire harness (WP 0460).

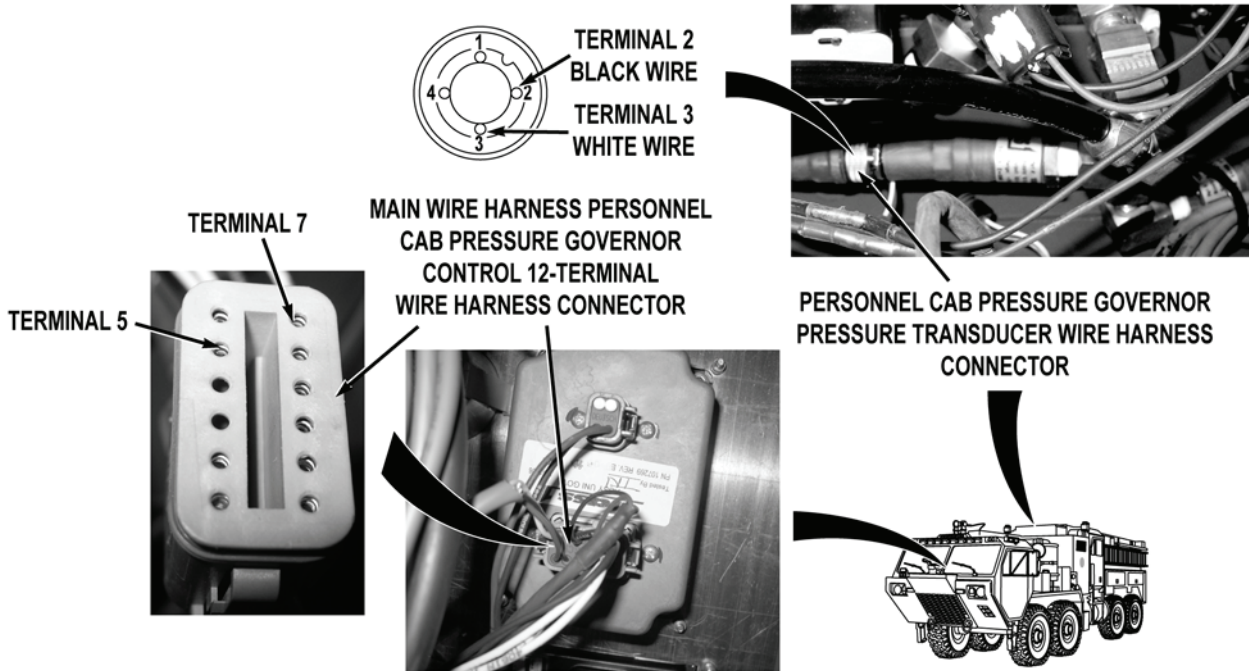

Step 12. With a test lead set, check for continuity across white wire from pressure transducer connector, terminal 3 to pressure governor 12-terminal connector, terminal 7.

If continuity is not present, replace pressure transducer wire harness (WP 0460).

Step 13. With a test lead set, check for continuity across black wire from pressure transducer connector, terminal 2 to pressure governor 12-terminal connector, terminal 5.

If continuity is not present, replace pressure transducer wire harness (WP 0460).

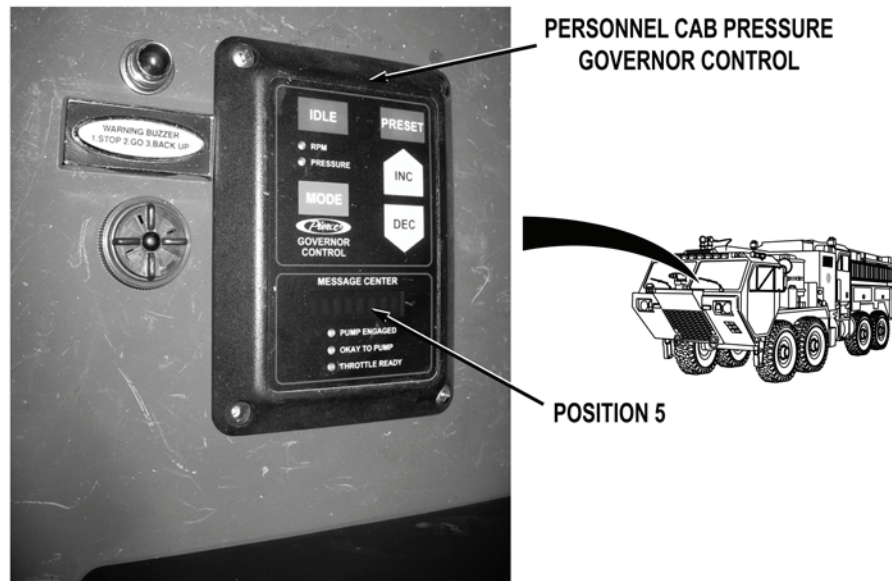

### NOTE

The message center must display MODE on pump operator's panel pressure governor MESSAGE CENTER before entering the password. Message center will display xxx3-5xx after entering self-test password.

- Step 14. Connect main wire harness personnel cab pressure governor 12-terminal wire harness connector. Connect personnel cab pressure governor pressure transducer wire harness connector. Turn battery disconnect switch to ON position (WP 0007). Start water pump engine (WP 0022). Push MODE switch on personnel cab pressure governor (WP 0004). Perform governor control panel self test on personnel cab pressure governor control by entering self-test password IDLE INC IDLE INC IDLE INC IDLE INC. Check for "5", H or F in position 5 when display enters self-test mode.
- a. If personnel cab pressure governor displays "5" or H in position 5, replace personnel cab pressure governor control panel (WP 0309).
  - b. If personnel cab pressure governor displays F in position 5, replace personnel cab pressure governor pressure transducer (WP 0411).

**END OF TASK**

### FOLLOW-ON MAINTENANCE

Remove wheel chocks (TM 9-2320-347-10)

**END OF TASK**

**END OF WORK PACKAGE**





**FIELD LEVEL MAINTENANCE**

**WATER PUMP ENGINE PRESSURE GOVERNOR CONTROL PANEL MESSAGE CENTER DISPLAYS SENSOR OR CAVITATE**

**INITIAL SETUP:**

**Tools and Special Tools**

Tool Kit, General Mechanic's: Automotive  
(WP 0622, Item 27)

**References**

WP 0007  
WP 0022  
WP 0024  
WP 0309  
WP 0311  
WP 0325

**References (continued)**

WP 0332  
WP 0411  
WP 0460

**Equipment Conditions**

Water pump engine OFF (WP 0022)  
Engine OFF (TM 9-2320-347-10)  
Wheels chocked (TM 9-2320-347-10)

**MALFUNCTION**

**TEST OR INSPECTION**

**CORRECTIVE ACTION**

**WATER PUMP ENGINE PRESSURE GOVERNOR CONTROL PANEL MESSAGE CENTER DISPLAYS SENSOR OR CAVITATE**



**PUMP OPERATOR'S PANEL**



**PRESSURE GOVERNOR CONTROL MESSAGE CENTER**



Step 1. Start water pump engine (WP 0022). Operate pump operator's panel pressure governor in PRESSURE mode (WP 0024). Check if pump operator's panel pressure governor control MESSAGE CENTER displays sensor or cavitate.

If pump operator's panel pressure governor does not display sensor or cavitate, go to Step 7.

**MALFUNCTION**

**TEST OR INSPECTION**

**CORRECTIVE ACTION**

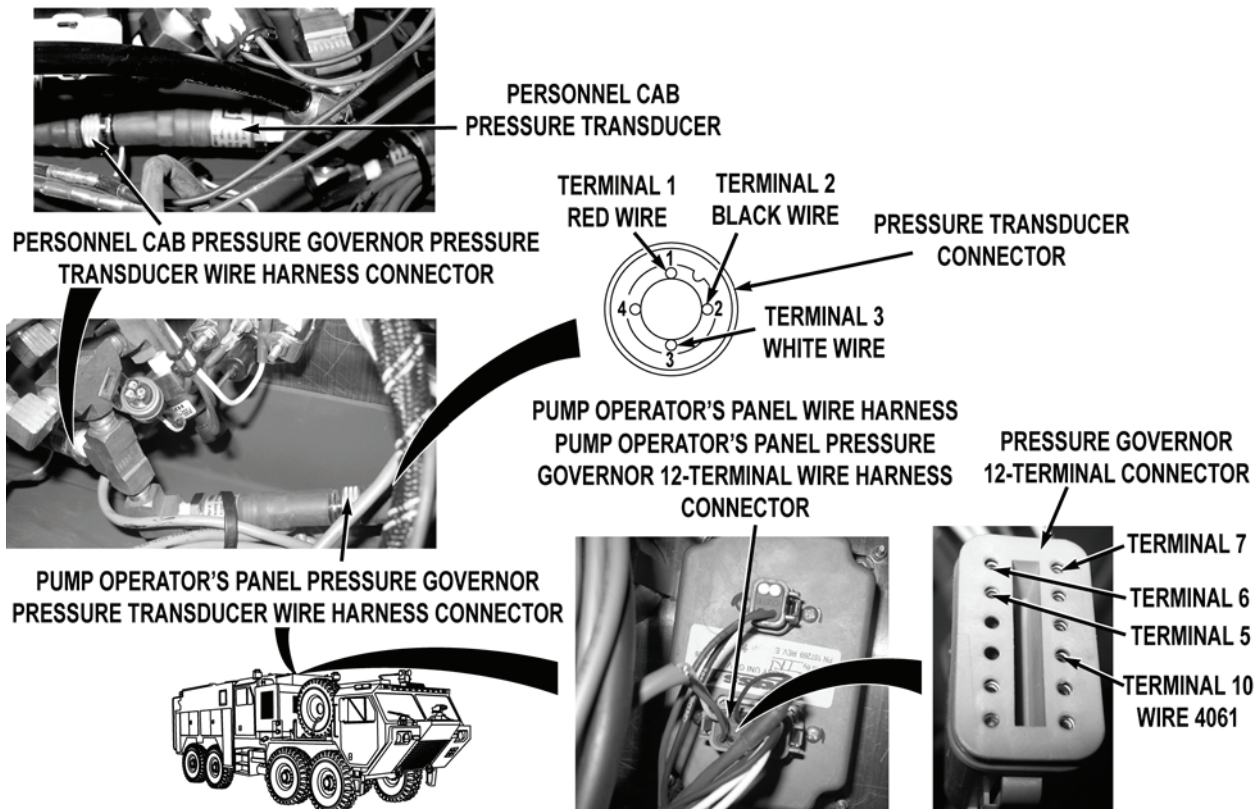

**WARNING**



Remove rings, wristwatches, neck chains, and any other jewelry before working around vehicle. Jewelry can catch on equipment and cause serious injury. Jewelry and tools may short across electrical circuits and cause damage to equipment, or severe burns or electrical shock to personnel.

**NOTE**

Sensor failure or problems may occur due to moisture and corrosion. Inspect pressure transducer and connector for damaged terminals, loose water seal wedge lock connections, moisture, corrosion, and other foreign objects, using a bright light.

**MALFUNCTION****TEST OR INSPECTION****CORRECTIVE ACTION**

- 
- Step 2. Turn water pump engine off (WP 0022). Turn battery disconnect switch to OFF position (WP 0007). Open pump operator's panel housing (WP 0325). Disconnect pump operator's panel wire harness pump operator's panel pressure governor 12-terminal wire harness connector. Disconnect pump operator's panel pressure governor pressure transducer wire harness connector. With a test lead set, check for continuity across red wire from pressure transducer connector, terminal 1 to pressure governor 12-terminal connector, terminal 6.
- If continuity is not present, replace pressure transducer wire harness (WP 0460).
- Step 3. With a test lead set, check for continuity across white wire from pressure transducer connector, terminal 3 to pressure governor 12-terminal connector, terminal 7.
- If continuity is not present, replace pressure transducer wire harness (WP 0460).
- Step 4. With a test lead set, check for continuity across black wire from pressure transducer connector, terminal 2 to pressure governor 12-terminal connector, terminal 5.
- If continuity is not present, replace pressure transducer wire harness (WP 0460).
- Step 5. Start water pump engine (WP 0022). With a test lead set, check for 22 to 28 VDC on wire 4061 from pressure governor 12-terminal connector, terminal 10 to a known good ground.
- If 22 to 28 VDC are present, replace personnel cab pressure governor control panel (WP 0309).
- Step 6. Turn water pump engine off (WP 0022). Disconnect personnel cab pressure governor pressure transducer wire harness connector. Connect pump operator's panel pressure governor pressure transducer wire harness connector to personnel cab pressure transducer. Start water pump engine (WP 0022). Operate pump operator's panel in PRESSURE mode (WP 0024). Check if sensor or cavitate is displayed on pump operator's panel pressure governor MESSAGE CENTER (WP 0004).
- a. If sensor or cavitate is displayed on pump operator's panel pressure governor MESSAGE CENTER, replace pump operator's panel governor control panel (WP 0332).
  - b. If sensor or cavitate is not displayed on pump operator's panel pressure governor MESSAGE CENTER, replace pressure transducer (WP 0411).

**MALFUNCTION**

**TEST OR INSPECTION**

**CORRECTIVE ACTION**

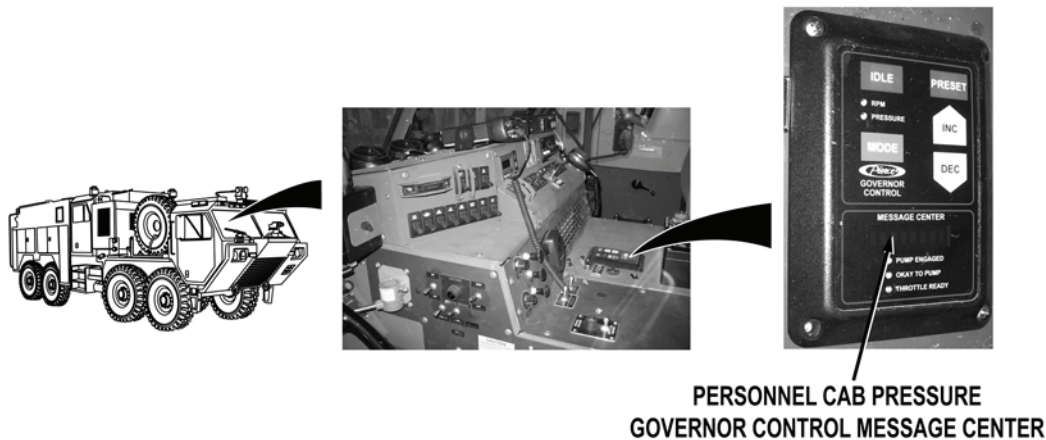

Step 7. Operate personnel cab pressure governor in PRESSURE mode (WP 0024). Check if personnel cab pressure governor control MESSAGE CENTER displays sensor or cavitate.

If personnel cab pressure governor does not display sensor or cavitate, fault corrected.

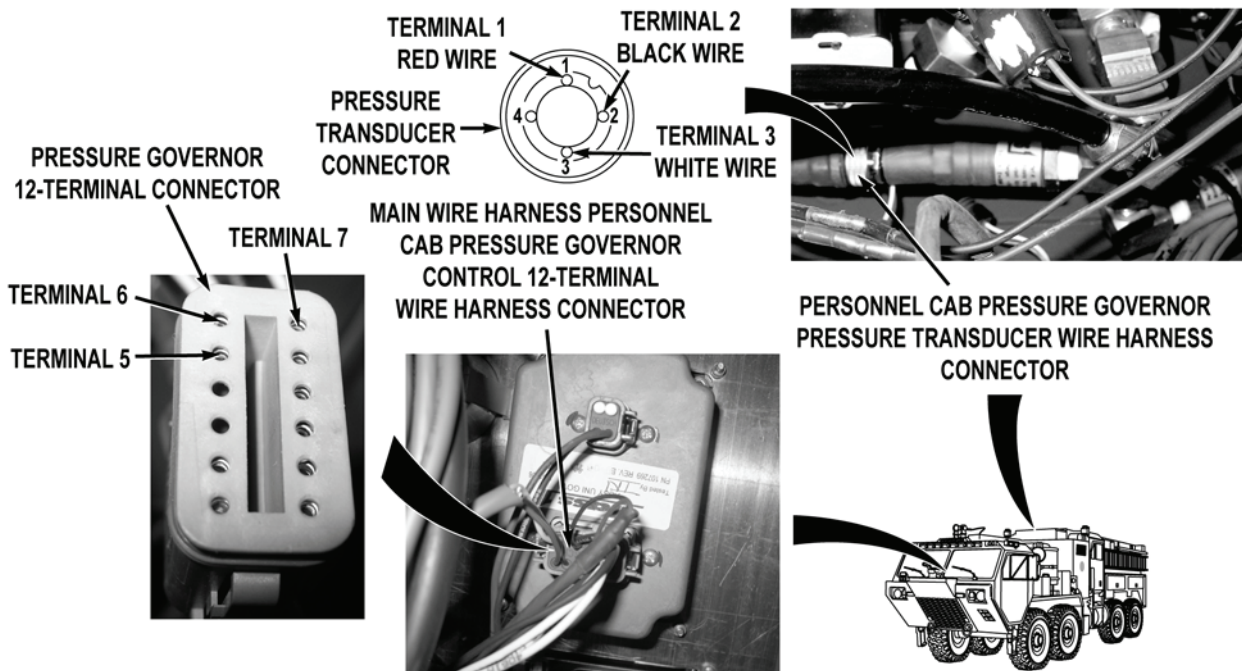

**MALFUNCTION****TEST OR INSPECTION****CORRECTIVE ACTION****WARNING**

**Remove rings, wristwatches, neck chains, and any other jewelry before working around vehicle. Jewelry can catch on equipment and cause serious injury. Jewelry and tools may short across electrical circuits and cause damage to equipment, or severe burns or electrical shock to personnel.**

**NOTE**

Sensor failure or problems may occur due to moisture and corrosion. Inspect pressure transducer and connector for damaged terminals, loose water seal wedge lock connections, moisture, corrosion, and other foreign objects, using a bright light.

- Step 8. Turn water pump engine off (WP 0022). Open pump operator's panel housing (WP 0325). Remove cab instrument panel E (WP 0311). Turn battery disconnect switch to OFF position (WP 0007). Disconnect main wire harness personnel cab pressure governor control 12-terminal wire harness connector. Disconnect personnel cab pressure governor pressure transducer wire harness connector. With a test lead set, check for continuity across red wire from pressure transducer connector, terminal 1 to pressure governor 12-terminal connector, terminal 6.

If continuity is not present, replace pressure transducer wire harness (WP 0460).

- Step 9. With a test lead set, check for continuity across white wire from pressure transducer connector, terminal 3 to pressure governor 12-terminal connector, terminal 7.

If continuity is not present, replace pressure transducer wire harness (WP 0460).

- Step 10. With a test lead set, check for continuity across black wire from pressure transducer connector, terminal 2 to pressure governor 12-terminal connector, terminal 5.

If continuity is not present, replace pressure transducer wire harness (WP 0460).

**MALFUNCTION**

**TEST OR INSPECTION**

**CORRECTIVE ACTION**

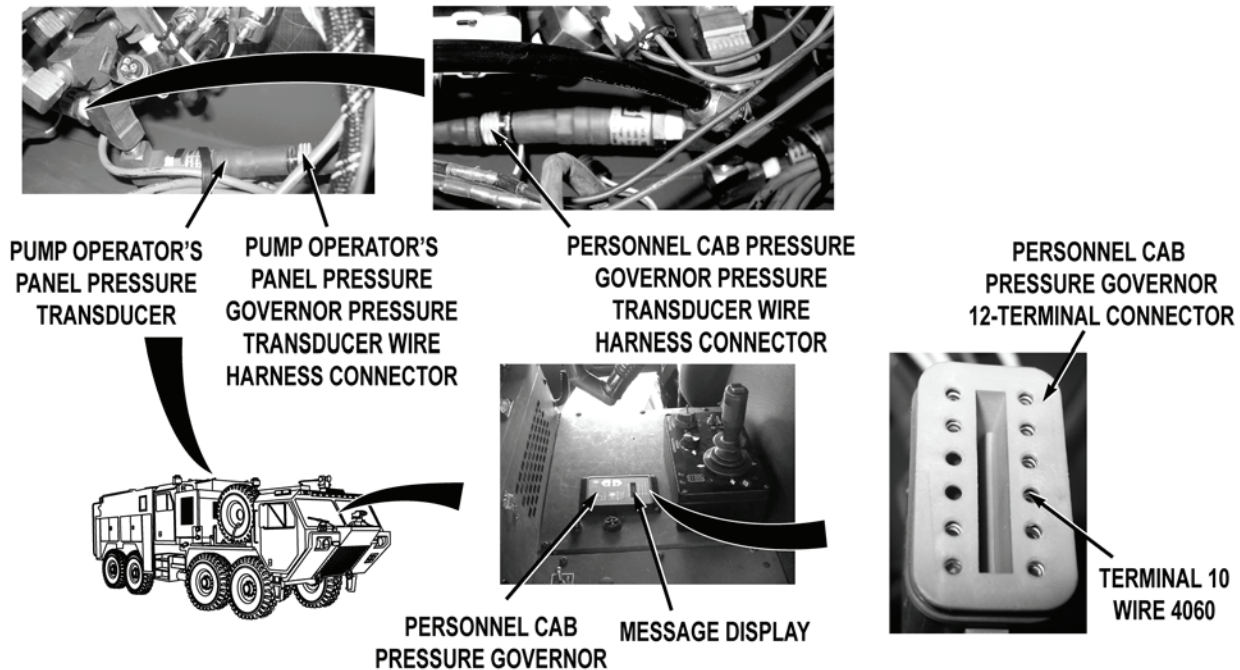

Step 11. Start water pump engine (WP 0022). With a test lead set, check for 22 to 28 VDC on wire 4060 from personnel cab pressure governor 12-terminal connector, terminal 10 to a known good ground.

If 22 to 28 VDC are present, replace personnel cab pressure governor control panel (WP 0309).

Step 12. Turn water pump engine off (WP 0022). Disconnect pump operator's panel pressure governor pressure transducer wire harness connector. Connect personnel cab pressure governor pressure transducer wire harness connector to pump operator's panel pressure transducer. Start water pump engine (WP 0022). Operate personnel cab pressure governor in PRESSURE mode (WP 0024). Check if sensor or cavitate is displayed on personnel cab pressure governor MESSAGE DISPLAY.

- a. If sensor or cavitate is displayed on personnel cab pressure governor MESSAGE CENTER, replace personnel cab governor control panel (WP 0309).
- b. If sensor or cavitate is not displayed on personnel cab pressure governor MESSAGE CENTER, replace pressure transducer (WP 0411).

**END OF TASK**

**FOLLOW-ON MAINTENANCE**

Remove wheel chocks (TM 9-2320-347-10)

**END OF TASK**

**END OF WORK PACKAGE**





**FIELD LEVEL MAINTENANCE**

**WATER PUMP ENGINE PRESSURE GOVERNOR CONTROL PANEL CHANGES ENGINE SPEED, BUT OSCILLATES WHILE IN RPM MODE**

**INITIAL SETUP:**

**Tools and Special Tools**

Lead Set, Test (WP 0622, Item 21)  
 Tool Kit, General Mechanic's: Automotive  
 (WP 0622, Item 27)

**Personnel Required**

MOS 63B Wheeled vehicle mechanic (2)

**References**

WP 0007  
 WP 0022  
 WP 0024  
 WP 0226  
 WP 0309

**References (continued)**

WP 0311  
 WP 0325  
 WP 0332  
 WP 0455  
 WP 0459  
 WP 0499  
 WP 0539  
 WP 0540

**Equipment Conditions**

Engine OFF (TM 9-2320-347-10)  
 Wheels chocked (TM 9-2320-347-10)

**MALFUNCTION**

**TEST OR INSPECTION**

**CORRECTIVE ACTION**

**WATER PUMP ENGINE PRESSURE GOVERNOR CONTROL PANEL CHANGES ENGINE SPEED, BUT OSCILLATES WHILE IN RPM MODE**

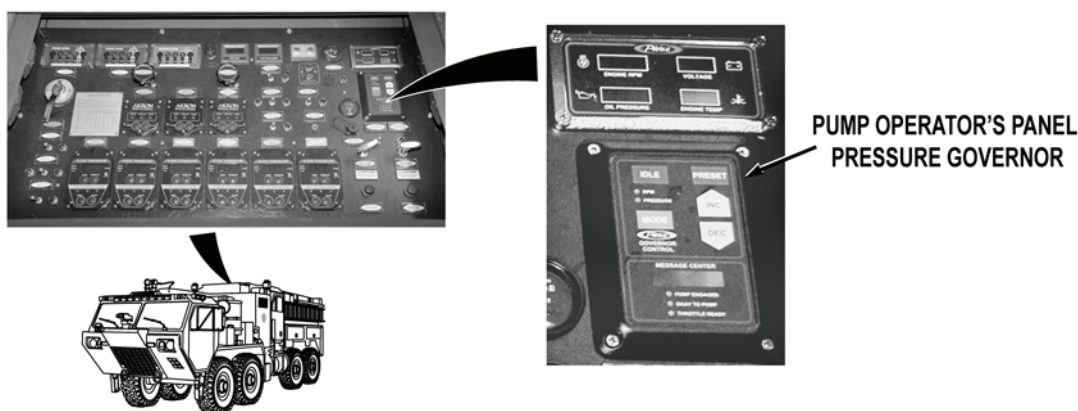

Step 1. Start water pump engine (WP 0022). Operate pump operator's panel pressure governor (WP 0024). Check if water pump engine RPM oscillates when pump operator's panel pressure governor is operated in RPM mode.

If water pump engine does not oscillate when pump operator's panel pressure governor is operated in RPM mode, go to Step 5.

**MALFUNCTION**

**TEST OR INSPECTION**

**CORRECTIVE ACTION**

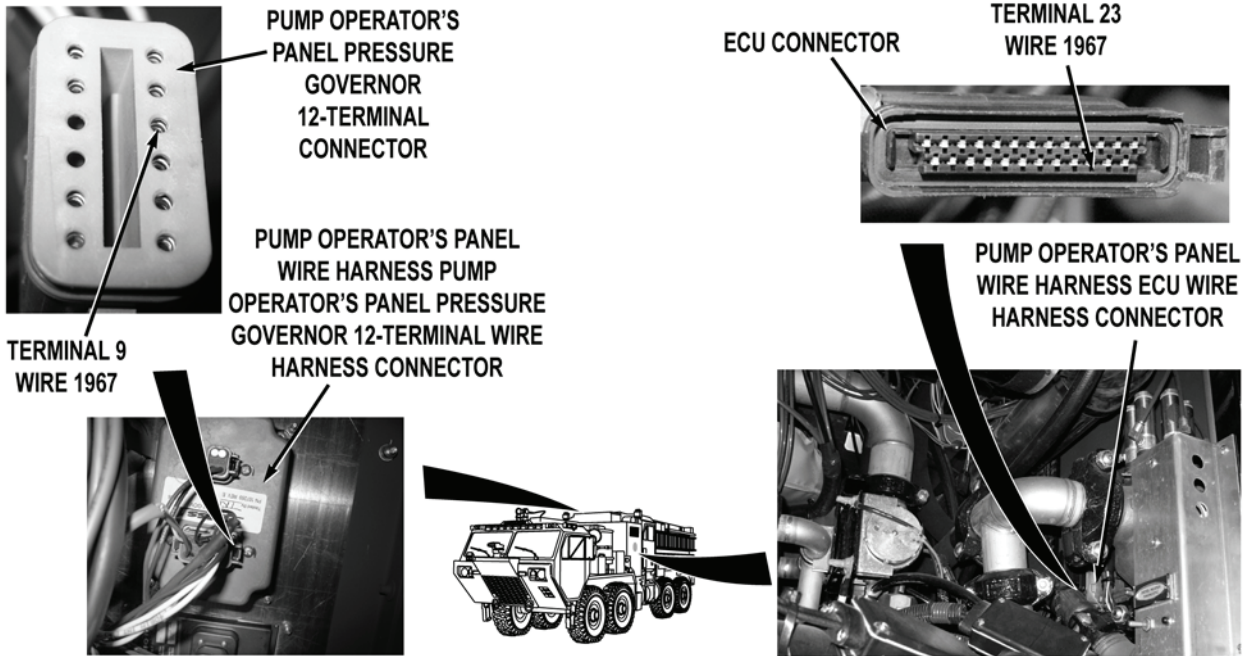

**WARNING**



**Remove rings, wristwatches, neck chains, and any other jewelry before working around vehicle. Jewelry can catch on equipment and cause serious injury. Jewelry and tools may short across electrical circuits and cause damage to equipment, or severe burns or electrical shock to personnel.**

Step 2. Turn water pump engine off (WP 0022). Turn battery disconnect switch to OFF position (WP 0007). Open pump house panel A (WP 0539). Disconnect pump operator's panel wire harness ECU wire harness connector. Open pump operator's panel housing (WP 0325). Disconnect pump operator's panel wire harness pump operator's panel pressure governor 12-terminal wire harness connector. With a test lead set, check for continuity across wire 1967 from pump operator's panel pressure governor 12-terminal connector, terminal 9 to ECU connector, terminal 23.

If continuity is not present, repair wire 1967 in pump operator's panel wire harness if repairable (TM 9-2320-325-14&P), or replace pump operator's panel wire harness (WP 0459).

## MALFUNCTION

## TEST OR INSPECTION

## CORRECTIVE ACTION

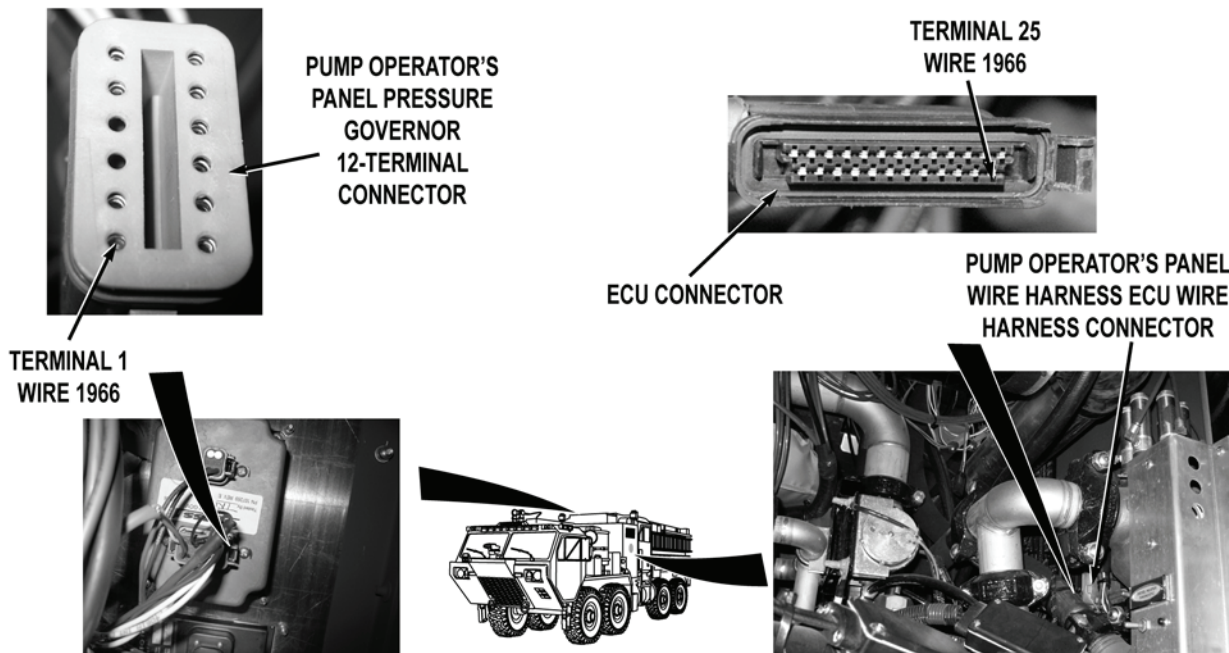

Step 3. With a test lead set, check for continuity across wire 1966 from pump operator's panel pressure governor 12-terminal connector, terminal 1 to ECU connector, terminal 25.

If continuity is not present, repair wire 1966 in pump operator's panel wire harness if repairable (TM 9-2320-325-14&P), or replace pump operator's panel wire harness (WP 0459).

Step 4. Reconnect pump operator's panel wire harness ECU wire harness connector. Turn battery disconnect switch to ON position (WP 0007). Start water pump engine (WP 0022). With a test lead set, check for voltage fluctuation of 0 to 5 VDC at wire 1966 from pump operator's panel pressure governor 12-terminal connector, terminal 1 to a known good ground.

- a. If steady 5 VDC are present, replace pump operator's panel pressure governor control panel (WP 0332).
- b. If steady 5 VDC are not present, replace water pump engine ECU (WP 0226).

**MALFUNCTION**

**TEST OR INSPECTION**

**CORRECTIVE ACTION**

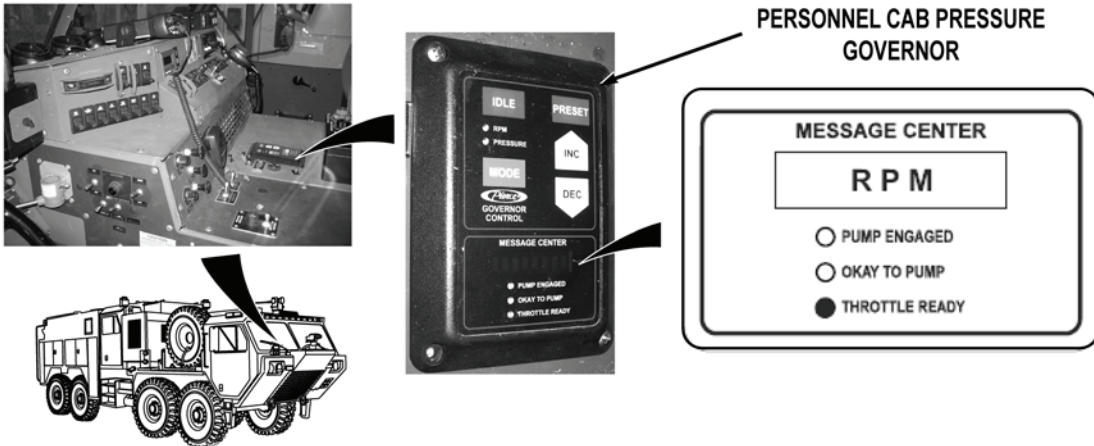

Step 5. Operate personnel cab pressure governor (WP 0024). Check if water pump engine RPM oscillates when personnel cab pressure governor is operated in RPM mode.

If water pump engine does not oscillate when personnel cab pressure governor is operated in RPM mode, fault corrected.

## MALFUNCTION

## TEST OR INSPECTION

## CORRECTIVE ACTION

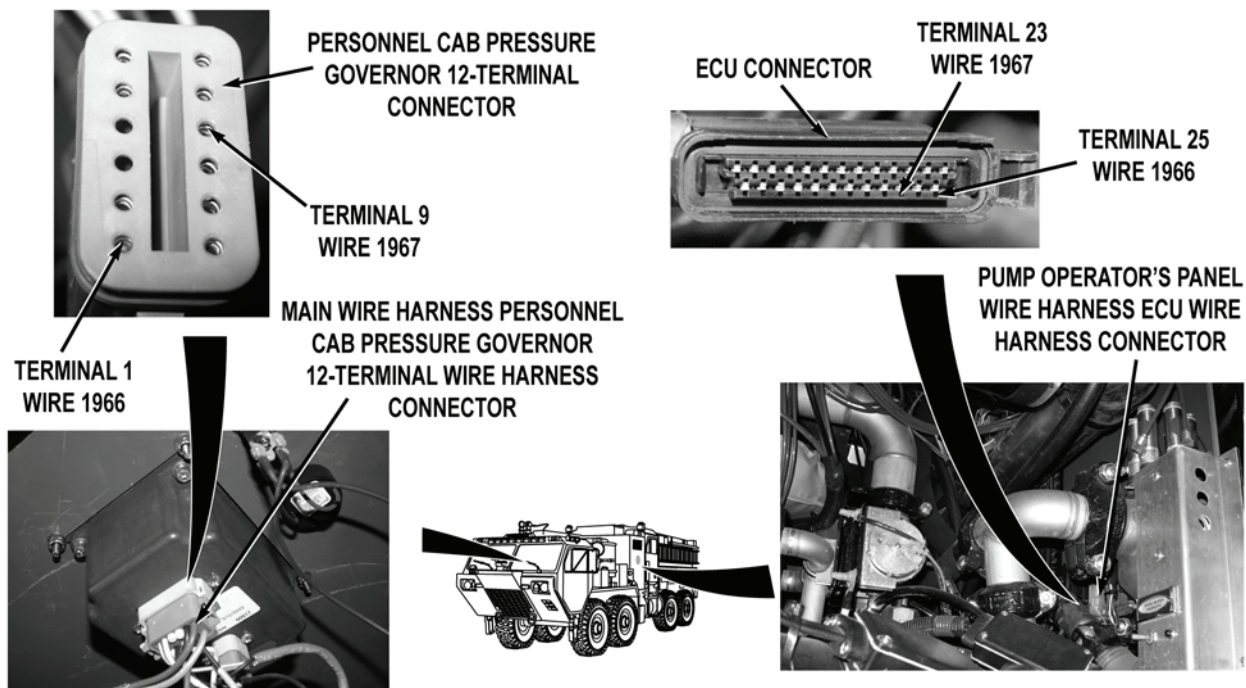
**WARNING**

Remove rings, wristwatches, neck chains, and any other jewelry before working around vehicle. Jewelry can catch on equipment and cause serious injury. Jewelry and tools may short across electrical circuits and cause damage to equipment, or severe burns or electrical shock to personnel.

- Step 6. Turn water pump engine off (WP 0022). Turn battery disconnect switch to OFF position (WP 0007). Remove cab instrument panel E (WP 0311). Disconnect main wire harness personnel cab pressure governor 12-terminal wire harness connector. Open pump house panel A (WP 0539). Disconnect pump operator's panel wire harness ECU wire harness connector. With a test lead set, check for continuity across wire 1967 from personnel cab pressure governor 12-terminal connector, terminal 9 to ECU connector, terminal 23.

If continuity is not present, go to Step 10.

- Step 7. With a test lead set, check for continuity across wire 1966 from personnel cab pressure governor 12-terminal connector, terminal 1 to ECU connector, terminal 25.

If continuity is not present, go to Step 9.

**MALFUNCTION****TEST OR INSPECTION****CORRECTIVE ACTION**

PUMP OPERATOR'S  
PANEL PRESSURE  
GOVERNOR  
12-TERMINAL  
WIRE HARNESS  
CONNECTOR

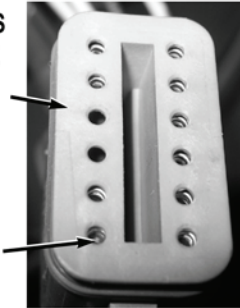

TERMINAL 1  
WIRE 1966

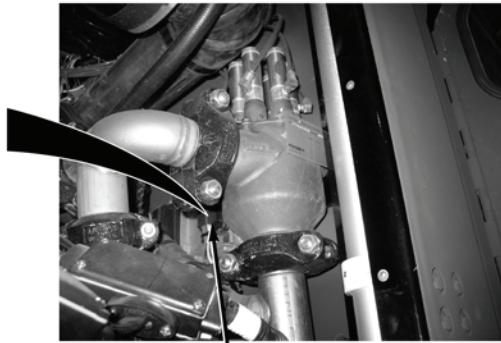

PUMP OPERATOR'S PANEL WIRE  
HARNESS ECU WIRE HARNESS CONNECTOR

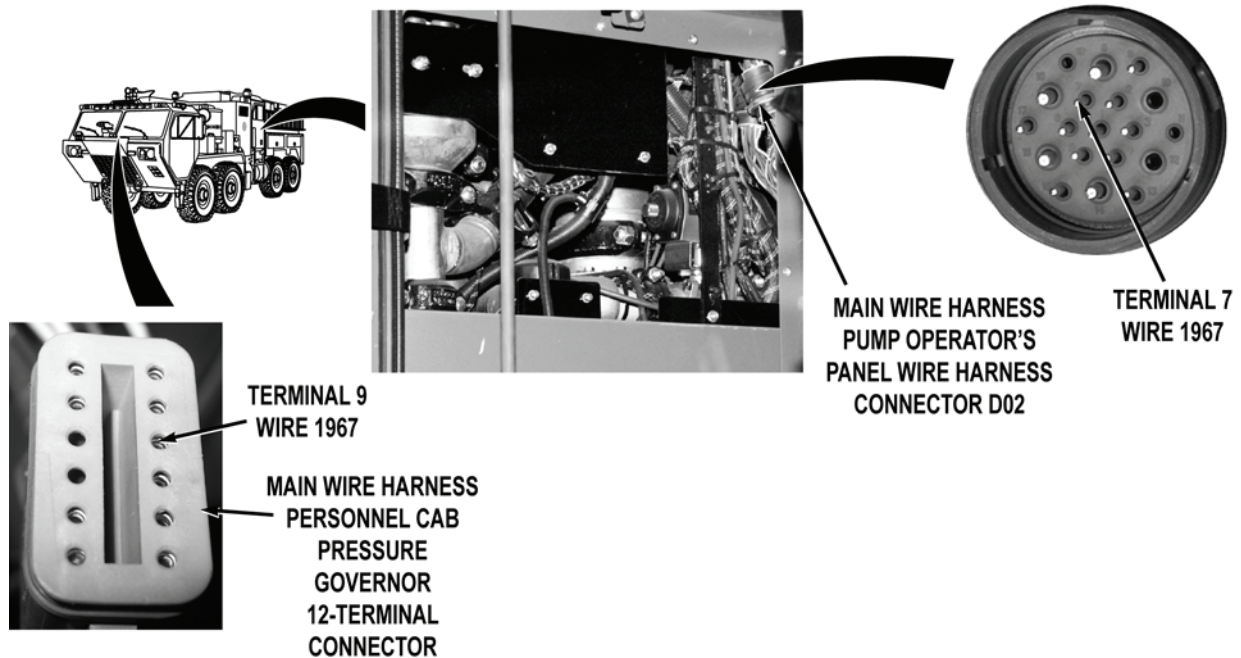

- Step 8. Reconnect pump operator's panel wire harness ECU wire harness connector. Turn battery disconnect switch to ON position (WP 0007). Start water pump engine (WP 0022). With a test lead set, check for voltage fluctuation of 0 to 5 VDC at wire 1966 from pump operator's panel pressure governor 12-terminal connector, terminal 1 to a known good ground.
- a. If steady 5 VDC are present, replace personnel cab governor control panel (WP 0309).
  - b. If steady 5 VDC are not present, replace water pump engine ECU (WP 0226).

**MALFUNCTION****TEST OR INSPECTION****CORRECTIVE ACTION****WARNING**

**Remove rings, wristwatches, neck chains, and any other jewelry before working around vehicle. Jewelry can catch on equipment and cause serious injury. Jewelry and tools may short across electrical circuits and cause damage to equipment, or severe burns or electrical shock to personnel.**

- Step 9. Remove driver side crew cab access panel (WP 0499). Remove pump house panel Q (WP 0540). Disconnect main wire harness pump operator's panel wire harness connector DO 2. With a test lead set, check for continuity across wire 1966 from main wire harness personnel cab pressure governor 12-terminal connector, terminal 1 to main wire harness pump operator's panel wire harness connector DO 2, terminal 6.
- a. If continuity is present, repair wire 1966 in pump operator's panel wire harness if repairable (TM 9-2320-325-14&P), or replace pump operator's panel wire harness (WP 0459).
  - b. If continuity is not present, repair wire 1966 in main wire harness if repairable (TM 9-2320-325-14&P), or replace main wire harness (WP 0455).

## MALFUNCTION

## TEST OR INSPECTION

## CORRECTIVE ACTION

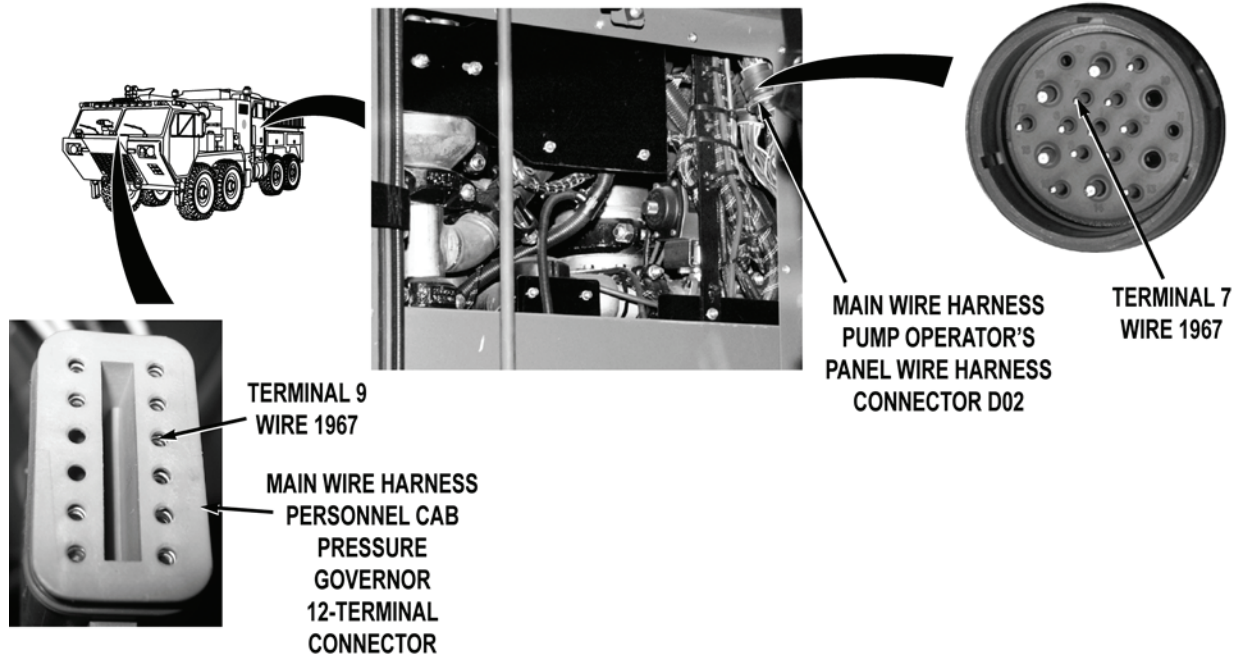
**WARNING**

Remove rings, wristwatches, neck chains, and any other jewelry before working around vehicle. Jewelry can catch on equipment and cause serious injury. Jewelry and tools may short across electrical circuits and cause damage to equipment, or severe burns or electrical shock to personnel.

- Step 10. Remove driver side crew cab access panel (WP 0499). Remove pump house panel Q (WP 0540). Disconnect main wire harness pump operator's panel wire harness connector DO2. With a test lead set, check for continuity across wire 1967 from main wire harness personnel cab pressure governor 12-terminal connector, terminal 9 to main wire harness pump operator's panel wire harness connector DO2, terminal 7.
- a. If continuity is present, repair wire 1967 in pump operator's panel wire harness if repairable (TM 9-2320-325-14&P), or replace pump operator's panel wire harness (WP 0459).
  - b. If continuity is not present, repair wire 1967 in main wire harness if repairable (TM 9-2320-325-14&P), or replace main wire harness (WP 0455).

END OF TASK



**FOLLOW-ON MAINTENANCE**

Remove wheel chocks (TM 9-2320-347-10)

**END OF TASK**

**END OF WORK PACKAGE**



---

**FIELD LEVEL MAINTENANCE**
**WATER PUMP ENGINE PRESSURE GOVERNOR CONTROL PANEL CHANGES ENGINE SPEED, BUT OSCILLATES WHILE IN PSI MODE**

---

**INITIAL SETUP:****Tools and Special Tools**

Tool Kit, General Mechanic's: Automotive  
(WP 0622, Item 27)

**Equipment Conditions**

Water pump engine OFF (WP 0022)  
Engine OFF (TM 9-2320-347-10)  
Wheels chocked (TM 9-2320-347-10)

**References**

WP 0022  
WP 0024  
WP 0080  
WP 0193

---

**MALFUNCTION****TEST OR INSPECTION****CORRECTIVE ACTION**

---

**WATER PUMP ENGINE PRESSURE GOVERNOR CONTROL PANEL CHANGES ENGINE SPEED, BUT OSCILLATES WHILE IN PSI MODE**

- Step 1. Start water pump engine (WP 0022). Operate pump operator's panel pressure governor in PRESSURE mode (WP 0024). Check if pump operator's panel pressure governor oscillates when in PRESSURE mode.
- If pump operator's panel pressure governor oscillates when in PRESSURE mode, go to Step 4.
- Step 2. Operate personnel cab pressure governor in PRESSURE mode (WP 0024). Check if personnel cab pressure governor oscillates when in PRESSURE mode.
- If personnel cab pressure governor does not oscillate when in PRESSURE mode, fault corrected.
- Step 3. Operate personnel cab pressure governor in RPM mode (WP 0024). Check if personnel cab pressure governor oscillates when in RPM mode.
- a. If personnel cab pressure governor oscillates in RPM mode, troubleshoot Water Pump Engine Pressure Governor Control Panel Changes Engine Speed, But Oscillates While In RPM Mode (WP 0080).
  - b. If personnel cab pressure governor does not oscillate in RPM mode, adjust pressure governor parameters (WP 0193).

- Step 4. Operate pump operator's panel pressure governor in RPM mode (WP 0024). Check if pump operator's panel pressure governor oscillates when in RPM mode.
- a. If pump operator's panel pressure governor oscillates in RPM mode, troubleshoot Water Pump Engine Pressure Governor Control Panel Changes Engine Speed, But Oscillates While In RPM Mode (WP 0080).
  - b. If pump operator's panel pressure governor does not oscillate in RPM mode, adjust pressure governor parameters (WP 0193).

**END OF TASK**

**FOLLOW-ON MAINTENANCE**

Remove wheel chocks (TM 9-2320-347-10)

**END OF TASK**

**END OF WORK PACKAGE**

---

**FIELD LEVEL MAINTENANCE**
**WATER PUMP ENGINE PRESSURE GOVERNOR CONTROLS DO NOT MAINTAIN SYSTEM PRESSURE  
WHEN DISCHARGE VALVE IS BEING OPENED OR CLOSED**

---

**INITIAL SETUP:****Tools and Special Tools**

Tool Kit, General Mechanic's: Automotive  
(WP 0622, Item 27)

**Equipment Conditions**

Engine OFF (TM 9-2320-347-10)  
Wheels chocked (TM 9-2320-347-10)

**References**

WP 0004  
WP 0022  
WP 0024  
WP 0193

---

**MALFUNCTION****TEST OR INSPECTION****CORRECTIVE ACTION**

---

**WATER PUMP ENGINE PRESSURE GOVERNOR CONTROLS DO NOT MAINTAIN SYSTEM PRESSURE  
WHEN DISCHARGE VALVE IS BEING OPENED OR CLOSED**

- Step 1. Start water pump engine (WP 0022). Operate pump operator's panel pressure governor and bring system to operating conditions (WP 0024). While observing system discharge pressure, open and close discharge valves (WP 0004).
- If system does not maintain discharge pressure, adjust pressure governor values (WP 0193).
- Step 2. Return system to idle (WP 0024). Operate personnel cab pressure governor and bring system to operating conditions (WP 0024). While observing system discharge pressure, open and close discharge valves (WP 0004).
- a. If system maintains discharge pressure, discharge valves are being operated too fast by operators.
  - b. If system does not maintain discharge pressure, adjust pressure governor values (WP 0193).

**END OF TASK****FOLLOW-ON MAINTENANCE**

Remove wheel chocks (TM 9-2320-347-10)

**END OF TASK****END OF WORK PACKAGE**



---

**FIELD LEVEL MAINTENANCE**
**WATER PUMP ENGINE PRESSURE GOVERNOR CONTROL PANEL PSI  
PRESET CONTROL DOES NOT OPERATE**

---

**INITIAL SETUP:****Tools and Special Tools**

Tool Kit, General Mechanic's: Automotive  
(WP 0622, Item 27)

**Equipment Conditions**

Water pump engine OFF (WP 0022)  
Engine OFF (TM 9-2320-347-10)  
Wheels chocked (TM 9-2320-347-10)

**References**

WP 0004  
WP 0022  
WP 0024  
WP 0078  
WP 0193

---

**MALFUNCTION****TEST OR INSPECTION****CORRECTIVE ACTION**

---

**WATER PUMP ENGINE PRESSURE GOVERNOR CONTROL PANEL PSI PRESET CONTROL DOES NOT  
OPERATE**
**NOTE**

Preset value for the pump operator's panel pressure governor control is set by manufacturer to 125 psi (862 kPa).

- Step 1. Start water pump engine (WP 0022). Operate pump operator's panel pressure governor in PSI mode (WP 0024). Press PRESET switch (WP 0004). Check if water pump pressure increases to preset value.

If water pump pressure does not increase to preset value, go to Step 4.

**NOTE**

Preset value for the pump operator's panel pressure governor control is set by manufacturer to 225 psi (1,551 kPa).

- Step 2. Operate personnel cab pressure governor in PSI mode (WP 0024). Press PRESET switch (WP 0004). Check if water pump pressure increases to preset value.

If water pump pressure increases to preset parameter, fault corrected.

**NOTE**

Message center will flash parameter settings. To determine pressure preset, watch for P225 for personnel cab pressure governor pressure preset value.

- Step 3. Check personnel cab pressure governor PSI preset by entering password INC IDLE IDLE INC IDLE INC IDLE INC. Record pressure preset value.
- a. If personnel cab pressure governor pressure preset is at proper value, troubleshoot water pump engine governor control panel does not change pump pressure (WP 0078).
  - b. If personnel cab pressure governor pressure preset is not at proper value, adjust pressure governor pressure preset (WP 0193).

**NOTE**

Message center will flash parameter settings. To determine pressure preset, watch for P125 for pump operator's panel pressure governor pressure preset value.

- Step 4. Check pump operator's panel pressure governor PSI preset by entering password INC IDLE IDLE INC IDLE INC IDLE INC. Record pressure preset value.
- a. If pump operator's panel pressure governor pressure preset is at proper value, troubleshoot water pump engine governor control panel does not change pump pressure (WP 0078).
  - b. If pump operator's panel pressure governor pressure preset is not at proper value, adjust pressure governor pressure preset (WP 0193).

**END OF TASK**

**FOLLOW-ON MAINTENANCE**

Remove wheel chocks (TM 9-2320-347-10)

**END OF TASK**

**END OF WORK PACKAGE**



**FIELD LEVEL MAINTENANCE**

**WATER PUMP ENGINE HOURMETER DOES NOT OPERATE**

**INITIAL SETUP:**

**Tools and Special Tools**

Tool Kit, General Mechanic's: Automotive  
(WP 0622, Item 27)

**References (continued)**

WP 0325  
WP 0459

**References**

TM 9-2320-325-14&P  
WP 0004  
WP 0007  
WP 0137  
WP 0324

**Equipment Conditions**

Water pump engine off (WP 0022)  
Engine OFF (TM 9-2320-347-10)  
Wheels chocked (TM 9-2320-347-10)

**MALFUNCTION**

**TEST OR INSPECTION**

**CORRECTIVE ACTION**

**WATER PUMP ENGINE HOURMETER DOES NOT OPERATE**

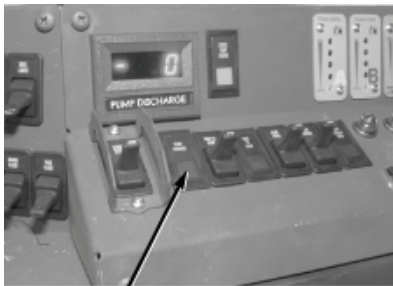

**PERSONNEL CAB  
PUMP RUNNING  
INDICATOR**



**PUMP OPERATOR'S PANEL  
PUMP ENGINE RUNNING  
INDICATOR**

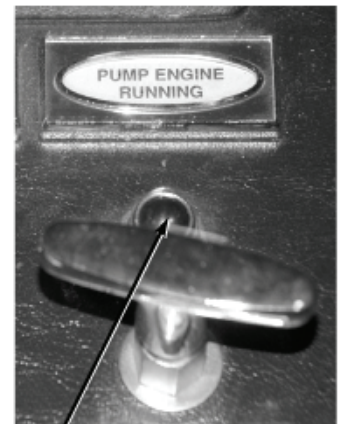

Step 1. Start water pump engine (WP 0022). Check if personnel cab PUMP RUNNING or pump operator's panel PUMP ENGINE RUNNING indicators illuminate (WP 0004).

If personnel cab PUMP RUNNING or pump operator's panel PUMP ENGINE RUNNING indicators do not illuminate, troubleshoot PUMP ENGINE RUNNING Indicator Not Illuminated When Water Pump Engine is Running (WP 0137).

## MALFUNCTION

## TEST OR INSPECTION

## CORRECTIVE ACTION

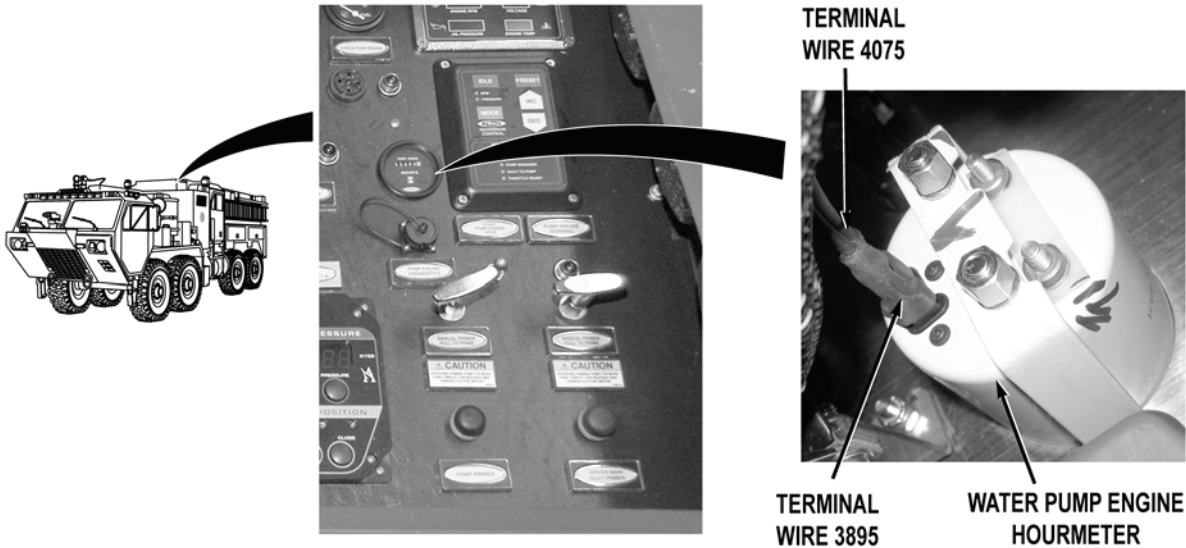
**WARNING**

Remove rings, wristwatches, neck chains, and any other jewelry before working around vehicle. Jewelry can catch on equipment and cause serious injury. Jewelry and tools may short across electrical circuits and cause damage to equipment, or severe burns or electrical shock to personnel.

- Step 2. Shut water pump engine off (WP 0022). Turn battery disconnect switch to OFF position (WP 0007). Open pump operator's panel housing (WP 0325). Disconnect wire 4075 (red) from water pump engine hourmeter. Turn battery disconnect switch to ON position (WP 0007). Start water pump engine (WP 0022). Check for 22 to 28 VDC at wire 4075 (red) at water pump engine hourmeter connector to a known good ground.

If 22 to 28 VDC are not present, repair wire 4075 in pump operator's panel wire harness (TM 9-2320-325-14&P), or replace pump operator's panel wire harness (WP 0459).

---

**MALFUNCTION****TEST OR INSPECTION****CORRECTIVE ACTION**

---

- Step 3. Disconnect wire 3895 (black) from water pump engine hourmeter. Check for continuity across wire 3895 (black) from water pump engine hourmeter connector to a known good ground.
- a. If continuity is present, replace pump operator's panel hourmeter (WP 0324).
  - b. If continuity is not present repair wire 3895 in pump operator's panel wire harness (TM 9-2320-325-14&P), or replace pump operator's panel wire harness (WP 0459).

**END OF TASK****FOLLOW-ON MAINTENANCE**

Remove wheel chocks (TM 9-2320-347-10)

**END OF TASK****END OF WORK PACKAGE**



---

**FIELD LEVEL MAINTENANCE**
**WATER PUMP ENGINE IS HARD TO START WHEN COLD, BELOW 32°F (0°C)**

---

**INITIAL SETUP:****Tools and Special Tools**

Lead Set, Test (WP 0622, Item 21)  
 Tool Kit, General Mechanic's: Automotive  
 (WP 0622, Item 27)

**References**

TM 9-2320-325-14&P  
 WP 0004  
 WP 0007  
 WP 0019  
 WP 0073  
 WP 0196  
 WP 0239

**References (continued)**

WP 0255  
 WP 0391  
 WP 0392  
 WP 0393  
 WP 0458  
 WP 0499  
 WP 0540

**Equipment Conditions**

Water pump engine OFF (WP 0022)  
 Engine OFF (TM 9-2320-347-10)  
 Wheels chocked (TM 9-2320-347-10)

---

**MALFUNCTION****TEST OR INSPECTION****CORRECTIVE ACTION**

---

**WATER PUMP ENGINE IS HARD TO START WHEN COLD, BELOW 32°F (0°C)**

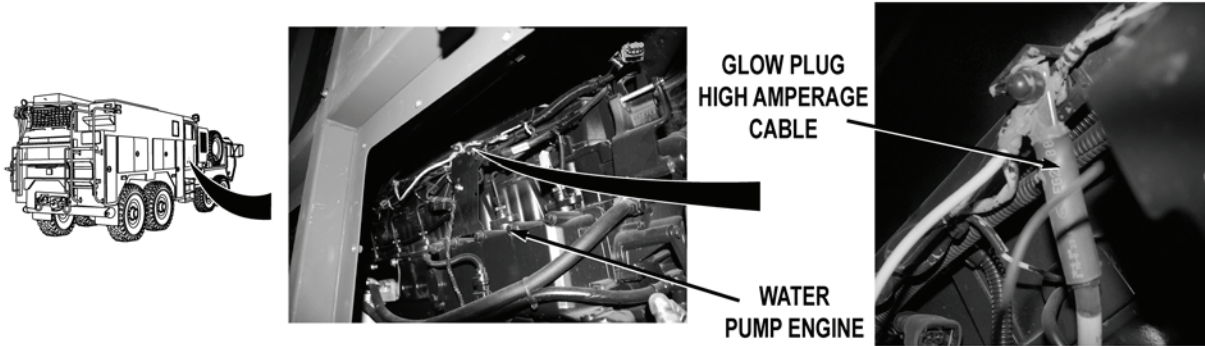
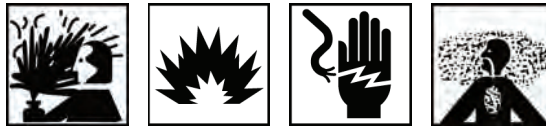
**MALFUNCTION****TEST OR INSPECTION****CORRECTIVE ACTION****WARNING**

- Do not use starting fluid as a starting aid. Glow plugs can ignite starting fluids. Failure to comply may result in death or serious injury to personnel and/or damage to equipment.
- Remove rings, wristwatches, neck chains, and any other jewelry before working around vehicle. Jewelry can catch on equipment and cause serious injury. Jewelry and tools may short across electrical circuits and cause damage to equipment, or severe burns or electrical shock to personnel.

**CAUTION**

Water pump engine must not be started during this procedure. Failure to comply may cause damage to equipment.

**NOTE**

Water pump engine preheat system is enabled when START PUMP ENGINE STOP switch is put to START position.

- Step 1. Remove passenger side crew cab access panel (WP 0499). Remove pump house panel O (WP 0540). Turn battery disconnect switch to ON position (WP 0007). Open pump operator's panel (WP 0019). Put START PUMP ENGINE STOP switch to START position (WP 0004), check for 22 to 28 VDC between glow plug high amperage cable and a known good ground.

If 22 to 28 VDC are not present, go to Step 3.

---

**MALFUNCTION****TEST OR INSPECTION****CORRECTIVE ACTION**

---

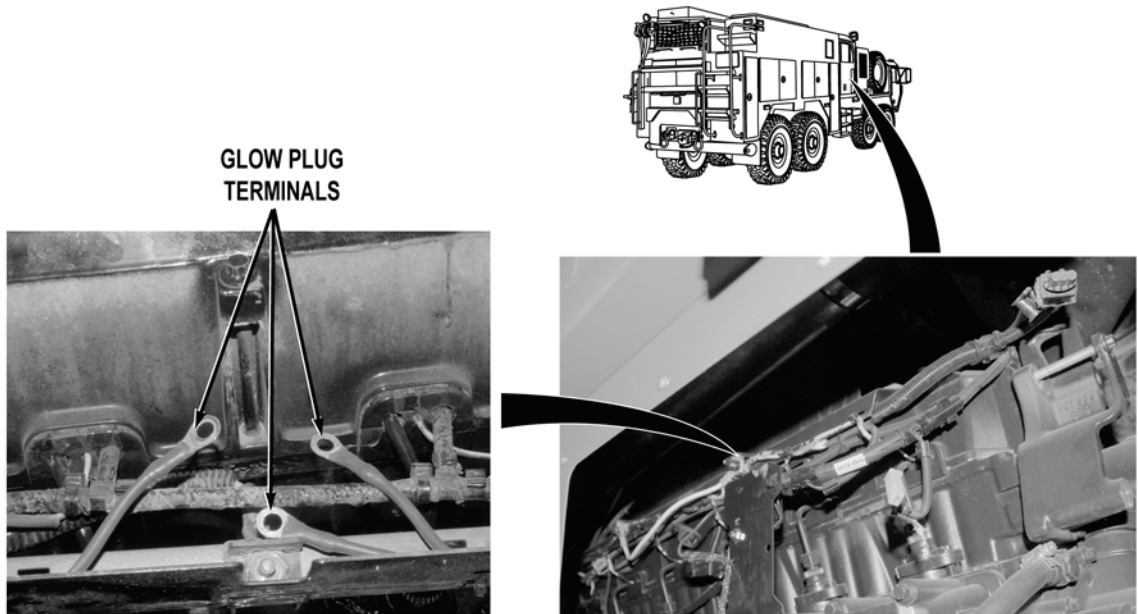
**NOTE**

Make sure that glow plug terminal does not come in contact with other glow plug terminals while performing resistance checks. Resistance of two or more glow plugs in a parallel circuit will change value of resistance measured.

- Step 2. Turn battery disconnect switch to OFF position (WP 0007). Checking individually, check for 1.5 to 2.5 ohms resistance across all six glow plugs from glow plug terminal to a known good ground.
- a. If there is 1.5 to 2.5 ohms resistance across all six glow plugs from glow plug terminal(s) to a known good ground, go to Step 8.
  - b. If there is greater than or less than 1.5 to 2.5 ohms resistance across any one or all glow plugs from glow plug terminal(s) to a known good ground, replace water pump engine glow plug(s) as needed (WP 0239).

**MALFUNCTION**

**TEST OR INSPECTION**

**CORRECTIVE ACTION**

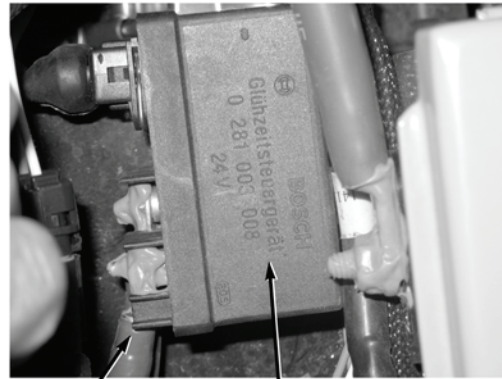

**HIGH AMPERAGE  
CABLE 1138**

**GLOW PLUG  
CONTROL RELAY**

Step 3. Remove pump house panel S (WP 0540). Check for 22 to 28 VDC between high amperage cable 1413766 (red) from glow plug control relay, terminal to a known good ground.

If 22 to 28 VDC are present, go to Step 6.

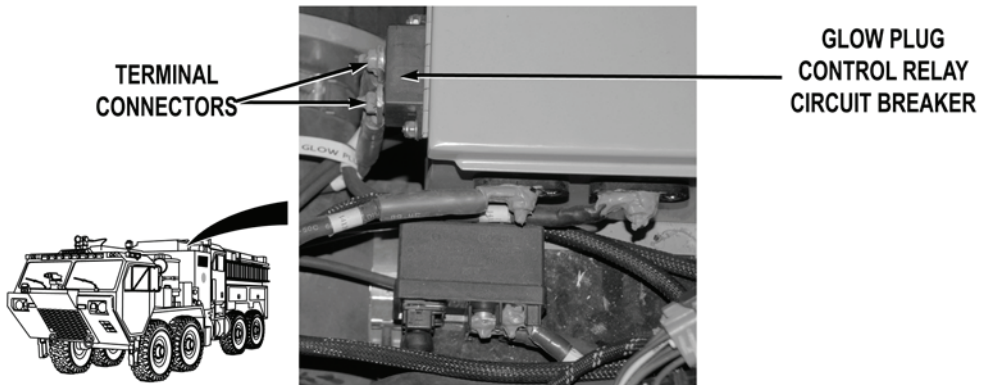

**TERMINAL  
CONNECTORS**

**GLOW PLUG  
CONTROL RELAY  
CIRCUIT BREAKER**

Step 4. Turn battery disconnect switch to OFF position (WP 0007). Check for continuity across glow plug control relay circuit breaker from terminal to terminal.

If there is no continuity across circuit breaker, replace glow plug control relay circuit breaker (WP 0391).



---

**MALFUNCTION****TEST OR INSPECTION****CORRECTIVE ACTION**

---

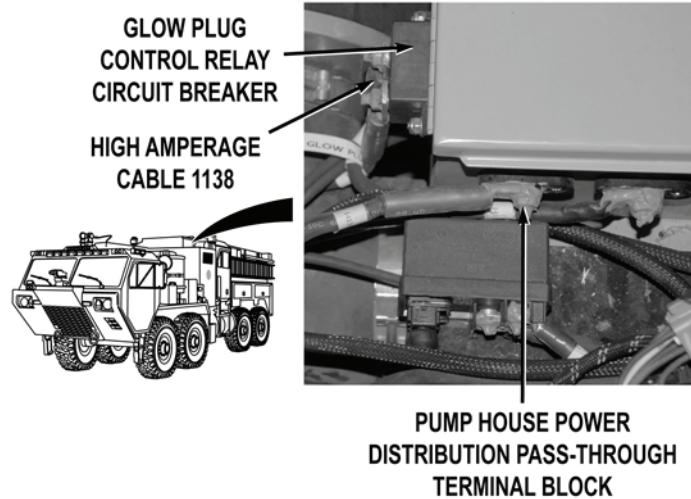

- Step 5. Check for continuity across high amperage cable 1138 (red) from glow plug control relay circuit breaker, terminal to pump house power distribution pass-through terminal block.
- a. If there is continuity, replace high amperage cable between glow plug control relay and glow plug control relay circuit breaker (WP 0393).
  - b. If there is no continuity, replace high amperage cable between pump house power distribution pass-through terminal block and glow plug control relay circuit breaker (WP 0393).

## MALFUNCTION

## TEST OR INSPECTION

## CORRECTIVE ACTION

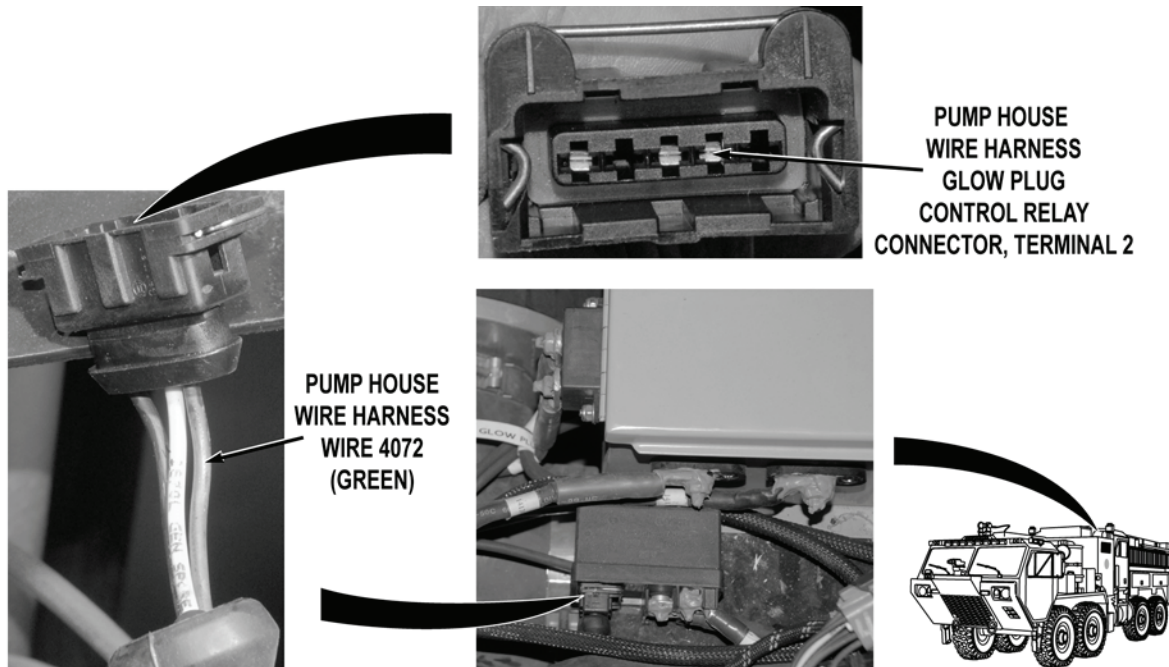
**WARNING**

Remove rings, wristwatches, neck chains, and any other jewelry before working around vehicle. Jewelry can catch on equipment and cause serious injury. Jewelry and tools may short across electrical circuits and cause damage to equipment, or severe burns or electrical shock to personnel.

- Step 6. Disconnect pump house wire harness glow plug control relay connector. While an assistant puts START PUMP ENGINE START switch to START position (WP 0004), check for 22 to 28 VDC across pump house wire harness wire 4072 (green) from pump house wire harness glow plug control relay connector, terminal 2 to a known good ground.

If 22 to 28 VDC are not present, repair wire 4072 in pump house wire harness if repairable (TM 9-2320-325-14&P), or replace pump house wire harness (WP 0458).

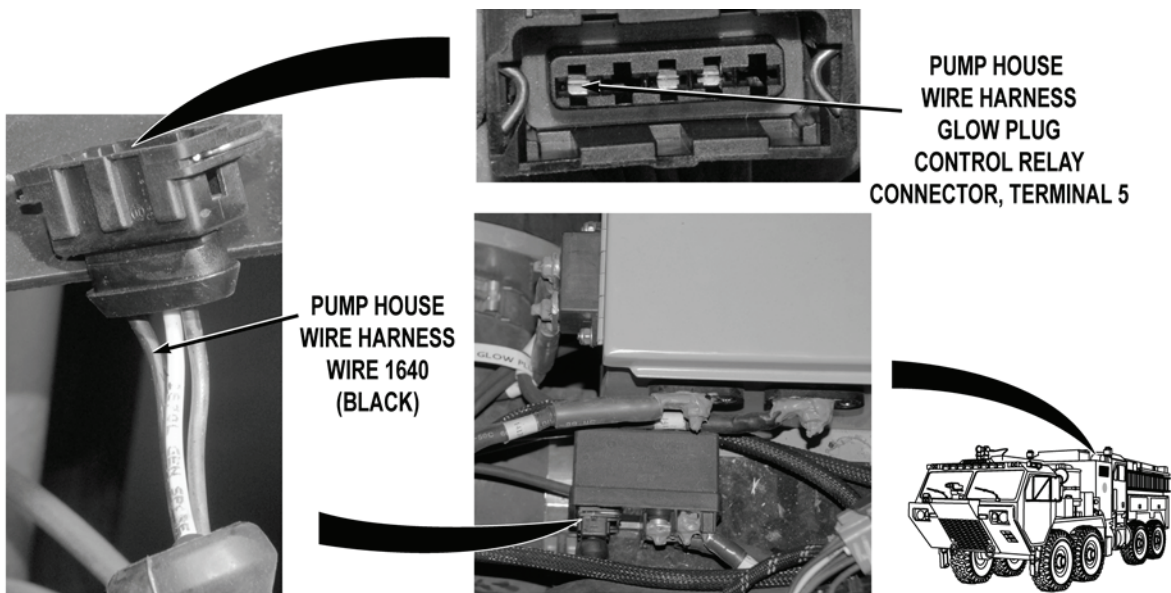
**MALFUNCTION****TEST OR INSPECTION****CORRECTIVE ACTION**

- Step 7. Turn battery disconnect switch to OFF position (WP 0007). Check for continuity across pump house wire harness wire 1640 (black) from pump house wire harness glow plug control relay connector, terminal 5 to a known good ground.
- a. If there is continuity, replace engine glow plug control relay (WP 0392).
  - b. If there is no continuity, repair wire 1640 in pump house wire harness if repairable (TM 9-2320-325-14&P), or replace pump house wire harness (WP 0458).
- Step 8. Perform water pump engine compression test (WP 0194). Check if water pump engine passes compression test.
- a. If water pump engine passes compression test, go to Water Pump Engine Cranks But Will Not Start or Hard to Start From Personnel Cab and Pump Operator's Panel (WP 0073).
  - b. If water pump engine does not pass compression test, replace water pump engine (WP 0255).

**END OF TASK****FOLLOW-ON MAINTENANCE**

Remove wheel chocks (TM 9-2320-347-10)

**END OF TASK****END OF WORK PACKAGE**



---

**FIELD LEVEL MAINTENANCE**
**WATER PUMP ENGINE IS PRODUCING BLUE EXHAUST SMOKE, WATER TEMP READS OVER 180°F (82°C)**

---

**INITIAL SETUP:****Tools and Special Tools**

Tool Kit, General Mechanic's: Automotive  
(WP 0622, Item 27)

**Equipment Conditions**

Water pump engine OFF (WP 0022)  
Engine OFF (TM 9-2320-347-10)  
Wheels chocked (TM 9-2320-347-10)

**References**

TM 9-2320-325-14&P  
WP 0022  
WP 0186  
WP 0219  
WP 0220  
WP 0243

---

**MALFUNCTION****TEST OR INSPECTION****CORRECTIVE ACTION**

---

**WATER PUMP ENGINE IS PRODUCING BLUE EXHAUST SMOKE, WATER TEMP READS OVER 180°F (82°C)**

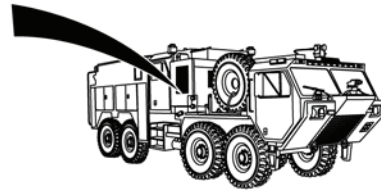
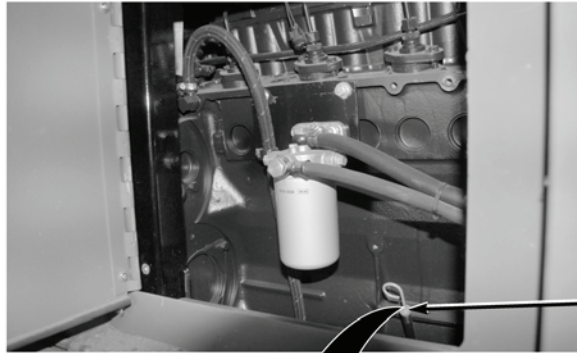
**MALFUNCTION****TEST OR INSPECTION****CORRECTIVE ACTION**

**WATER PUMP ENGINE  
OIL LEVEL DIPSTICK**



**FULL MARK**

**ADD MARK**

** CAUTION**

**Water pump engine oil is at proper level when oil is between full and add marks on oil level dipstick. Failure to comply may cause damage to equipment.**

**NOTE**

Water pump engine must be stopped for at least five minutes before oil level can be checked accurately.

- Step 1. Open crew cab water pump engine access door. Check if water pump engine oil level is above full mark (WP 0186).

If water pump engine oil level is above full mark, drain engine oil to achieve proper level (WP 0243).

- Step 2. Replace water pump engine pressure regulator (WP 0220). Start water pump engine (WP 0022). Check if water pump engine is producing blue exhaust smoke when water temperature reaches 180°F (82°C) or greater.

- a. If water pump engine is producing blue exhaust smoke with water temperature over 180°F (82°C), go to Step 3.
- b. If water pump engine is not producing blue exhaust smoke with water temperature over 180°F (82°C), fault corrected.

---

**MALFUNCTION****TEST OR INSPECTION****CORRECTIVE ACTION**

---

- Step 3. Change water pump engine oil (WP 0243). Start water pump engine (WP 0022). Check if water pump engine is producing blue exhaust smoke when water temperature reaches 180°F (82°C) or greater.
- a. If water pump engine is producing blue exhaust smoke when water temperature is over 180°F (82°C), replace water pump engine (WP 0219).
  - b. If water pump engine is not producing blue exhaust smoke when water temperature is over 180°F (82°C), fault corrected.

**END OF TASK****FOLLOW-ON MAINTENANCE**

1. Stop water pump engine (WP 0022)
2. Remove wheel chocks (TM 9-2320-347-10)

**END OF TASK****END OF WORK PACKAGE**





**FIELD LEVEL MAINTENANCE**

**WATER PUMP ENGINE IS PRODUCING EXCESSIVE BLACK OR GRAY EXHAUST SMOKE, WATER TEMP READS OVER 180°F (82°C)**

**INITIAL SETUP:**

**Tools and Special Tools**

Tool Kit, General Mechanic's: Automotive  
(WP 0622, Item 27)

**Personnel Required**

MOS 63B Wheeled vehicle mechanic (2)

**References**

WP 0196  
WP 0220  
WP 0221

**References (continued)**

WP 0222  
WP 0233  
WP 0240  
WP 0540

**Equipment Conditions**

Water pump engine OFF (WP 0022)  
Engine OFF (TM 9-2320-347-10)  
Wheels chocked (TM 9-2320-347-10)

**MALFUNCTION**

**TEST OR INSPECTION**

**CORRECTIVE ACTION**

**WATER PUMP ENGINE IS PRODUCING EXCESSIVE BLACK OR GRAY EXHAUST SMOKE, WATER TEMP READS OVER 180°F (82°C)**

- Step 1. Remove water pump engine air intake pre-filter (WP 0222). Check if pre-filter is free from dirt and damage.  
  
If pre-filter is not free from dirt or damage, replace water pump engine pre-filter (WP 0222).
- Step 2. Remove water pump engine air cleaner (WP 0220). Check if air cleaner is free from blockage or damage.  
  
If air cleaner is not free from blockage or damage, remove blockage or replace water pump engine air cleaner (WP 0220).
- Step 3. Remove water pump engine air filter ductwork (WP 0221). Check water pump engine air filter ductwork for blockage or damage.  
  
If water pump engine air filter ductwork is not free from blockage or damage, remove blockage or replace water pump engine air filter ductwork (WP 0221).
- Step 4. Remove pump house panel J (WP 0540). Check if water pump engine heat exchanger is free from damage.  
  
If water pump engine heat exchange is damaged, replace water pump engine heat exchanger (WP 0240).

---

**MALFUNCTION****TEST OR INSPECTION****CORRECTIVE ACTION**

---

- Step 5. Remove water pump engine fuel injectors (WP 0233). Perform injector nozzle pressure check (WP 0196).
- a. If fuel injectors do not pass pressure test, replace fuel injectors (WP 0233).
  - b. If fuel injectors pass pressure test, notify Supervisor.

**END OF TASK****FOLLOW-ON MAINTENANCE**

1. Install pump house panel J if removed (WP 0540)
2. Remove wheel chocks (TM 9-2320-347-10)

**END OF TASK****END OF WORK PACKAGE**

---

**FIELD LEVEL MAINTENANCE**
**WATER PUMP ENGINE IS PRODUCING WHITE EXHAUST SMOKE, WATER  
TEMP READS OVER 180°F (82°C)**

---

**INITIAL SETUP:****Tools and Special Tools**

Tool Kit, General Mechanic's: Automotive  
(WP 0622, Item 27)

**Personnel Required**

MOS 63B Wheeled vehicle mechanic (2)

**References**

WP 0022  
WP 0089

**References (continued)**

WP 0196  
WP 0219  
WP 0233  
WP 0478

**Equipment Conditions**

Engine OFF (TM 9-2320-347-10)  
Wheels chocked (TM 9-2320-347-10)

---

**MALFUNCTION****TEST OR INSPECTION****CORRECTIVE ACTION**

---

**WATER PUMP ENGINE IS PRODUCING WHITE EXHAUST SMOKE, WATER TEMP READS OVER 180°F  
(82°C)**

Step 1. Start water pump engine (WP 0022). Check if water pump engine runs rough.

If water pump engine runs rough, troubleshoot Water Pump Engine Misfires, Runs Rough, or Lacks Power (WP 0089).

**WARNING**

**Allow engine to completely cool before handling any cooling system component or hose. Failure to comply may result in serious injury to personnel.**

**NOTE**

Step 2 will check for internal damage to water pump engine causing coolant to enter combustion chamber. Do not pressurize cooling system with pressure tester for this test.

Step 2. Stop water pump engine (WP 0022). Install coolant system pressure tester (WP 0478). While an assistant starts water pump engine (WP 0022), check if coolant pressure system tester shows pressure increase just after starting water pump engine.

If coolant pressure system tester shows pressure increase just after starting water pump engine, replace water pump engine (WP 0219).

Step 3. Stop water pump engine (WP 0022). Perform water pump engine compression test (WP 0194). Check if water pump engine passes compression test.

If water pump engine does not pass compression test, replace water pump engine (WP 0219).

---

**MALFUNCTION****TEST OR INSPECTION****CORRECTIVE ACTION**

---

- Step 4. Remove water pump engine fuel injector (WP 0233). Perform injector nozzle pressure check (WP 0196).
- a. If fuel injector nozzle(s) do not pass pressure test, replace fuel injector nozzle(s) (WP 0233).
  - b. If fuel injector nozzle(s) pass pressure test, notify Supervisor.

**END OF TASK****FOLLOW-ON MAINTENANCE**

1. Install pump house panel U (WP 0540)

**END OF TASK****END OF WORK PACKAGE**

**FIELD LEVEL MAINTENANCE**

**WATER PUMP ENGINE MISFIRES, RUNS ROUGH, OR LACKS POWER**

**INITIAL SETUP:**

**Tools and Special Tools**

Tool Kit, General Mechanic's: Automotive  
(WP 0622, Item 27)

**Personnel Required**

MOS 63B Wheeled vehicle mechanic (2)

**References**

TM 9-2320-325-14&P  
WP 0004  
WP 0007  
WP 0010  
WP 0022  
WP 0023  
WP 0194  
WP 0195  
WP 0196

**References (continued)**

WP 0219  
WP 0231  
WP 0233  
WP 0234  
WP 0236  
WP 0237  
WP 0243  
WP 0251  
WP 0325  
WP 0394  
WP 0499  
WP 0540

**Equipment Conditions**

Water pump engine OFF (WP 0022)  
Engine OFF (TM 9-2320-347-10)  
Wheels chocked (TM 9-2320-347-10)

**MALFUNCTION**

**TEST OR INSPECTION**

**CORRECTIVE ACTION**

**WATER PUMP ENGINE MISFIRES, RUNS ROUGH, OR LACKS POWER**

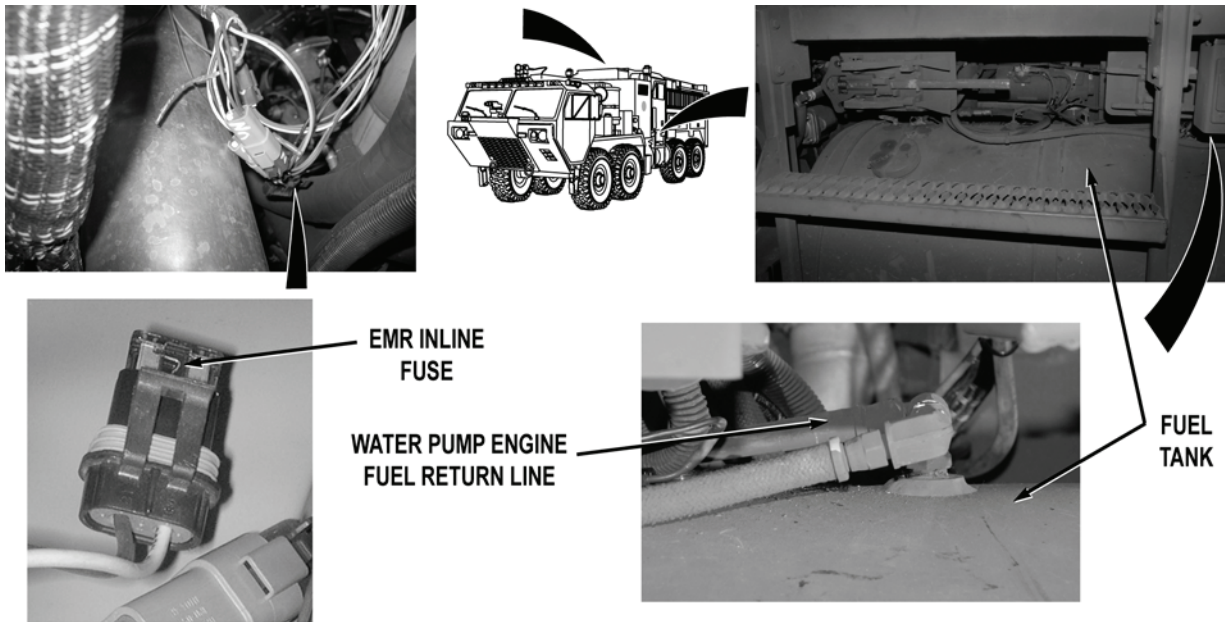

### NOTE

Water pump engine and vehicle engine share same fuel source. If fuel is contaminated or incorrect type, it will be necessary to drain fuel tank, lines, and replace all fuel filters for both water pump engine and vehicle engine.

- Step 1. Start vehicle engine (TM 9-2320-347-10). Check if vehicle engine misfires, runs rough, or lacks power.

If vehicle engine misfires, runs rough, or lacks power, drain vehicle fuel tank (TM 9-2320-347-10).

### NOTE

Water pump engine is disabled once water pump engine EMR inline fuse is removed.

- Step 2. Open pump operator's panel housing (WP 0325). Remove water pump engine EMR inline fuse (WP 0394). Disconnect water pump engine fuel return line from fuel tank and place fuel line in a suitable container. Turn battery disconnect switch to ON position (WP 0007). While an assistant puts pump operator's panel START PUMP ENGINE START switch to START position (WP 0004), check if fuel flow is weak or aerated. Connect water pump engine return fuel line on fuel tank (WP 0234).

If fuel flow is not weak or aerated, go to Step 7.

- Step 3. Open passenger side crew cab water pump engine compartment door (WP 0010). Remove pump house panel O (WP 0540). Remove passenger side crew cab access panel (WP 0499). Inspect supply fuel lines for loose fittings, kinks, and damage (WP 0234).

If fuel lines have loose fittings, are kinked or damaged, tighten loose fittings or replace kinked or damage fuel lines (WP 0234) and install water pump engine EMR inline fuse (WP 0394).

- Step 4. Inspect water pump engine coolant/fuel pump belt for serviceability and loose condition (WP 0195).

If water pump engine coolant/fuel pump belt is unserviceable or loose, replace or tighten belt (WP 0195).

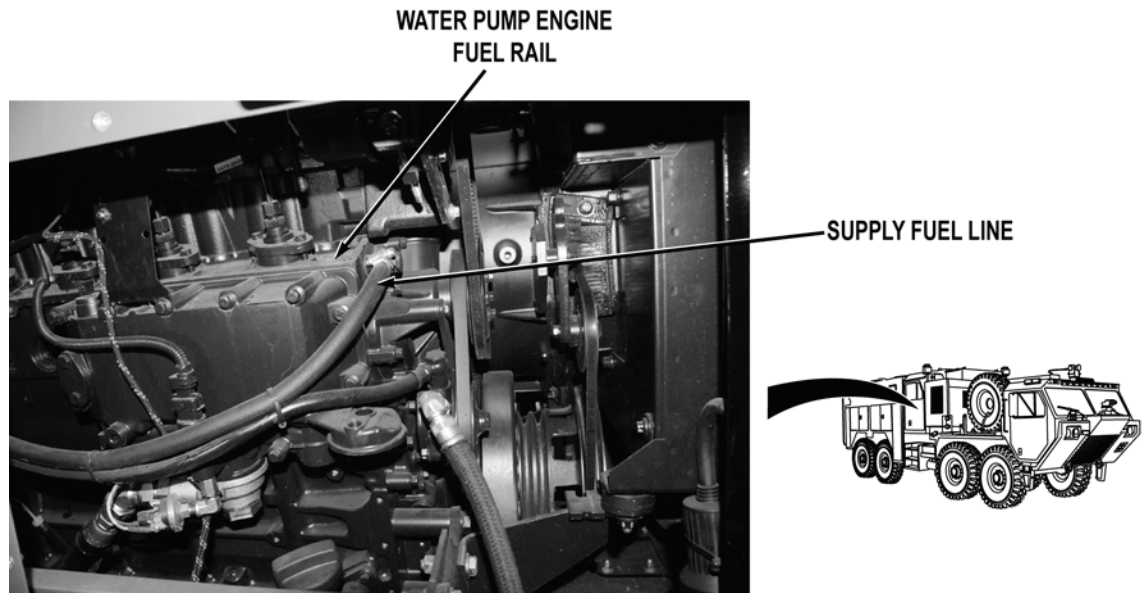

- Step 5. Disconnect supply fuel line at water pump engine fuel rail (WP 0234). With a pressure gauge, check for 16 psi (110 kPa) fuel pressure at supply fuel line which was disconnected from water pump engine fuel rail.

If 16 psi (110 kPa) fuel pressure is not present, replace secondary fuel filter (WP 0231) and go to Step 6.

- Step 6. Replace fuel/water separator filter (WP 0238). Replace secondary fuel filter (WP 0231). With a pressure gauge, check for 16 psi (110 kPa) fuel pressure at supply fuel line which was disconnected from water pump engine fuel rail.
- If 16 psi (110 kPa) is present, fault corrected.
  - If 16 psi (110 kPa) is not present, replace water pump engine fuel pump (WP 0236).

 **CAUTION**

- **Water pump is constantly engaged and operates whenever water pump engine is running. At least one water inlet valve must be opened whenever water pump engine is running. A pressure reading on PUMP DISCHARGE gauge (engine running) indicates adequate water supply to water pump for cooling. Failure to comply may result in water pump overheating and will cause damage to equipment.**
- **Water pump must be primed when operating water pump engine. Failure to prime water pump when operating water pump engine will cause damage to equipment.**

Step 7. Bleed water pump engine fuel system (WP 0237). Install water pump engine EMR inline fuse (WP 0394). Start water pump engine (WP 0022). Prime water pump (WP 0023). Allow water pump engine to operate to 180°F (82°C). Check if water pump engine misfires, runs rough, or lacks power.

If water pump engine does not misfire, run rough, or lack power, fault corrected.

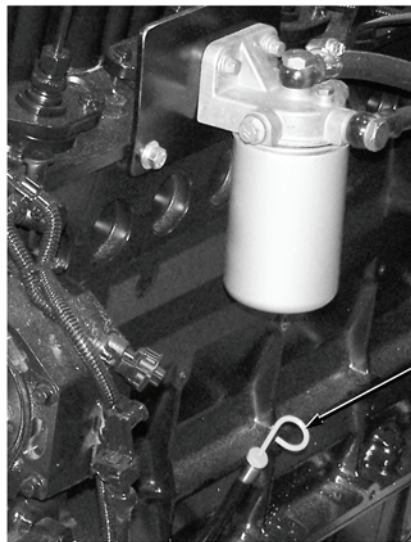

WATER PUMP  
ENGINE DIPSTICK

Step 8. Remove water pump engine dipstick (WP 0243). Inspect water pump engine dipstick for signs of raw fuel.

If water pump engine oil does not show signs of raw fuel, install water pump engine dipstick and go to Step 10.



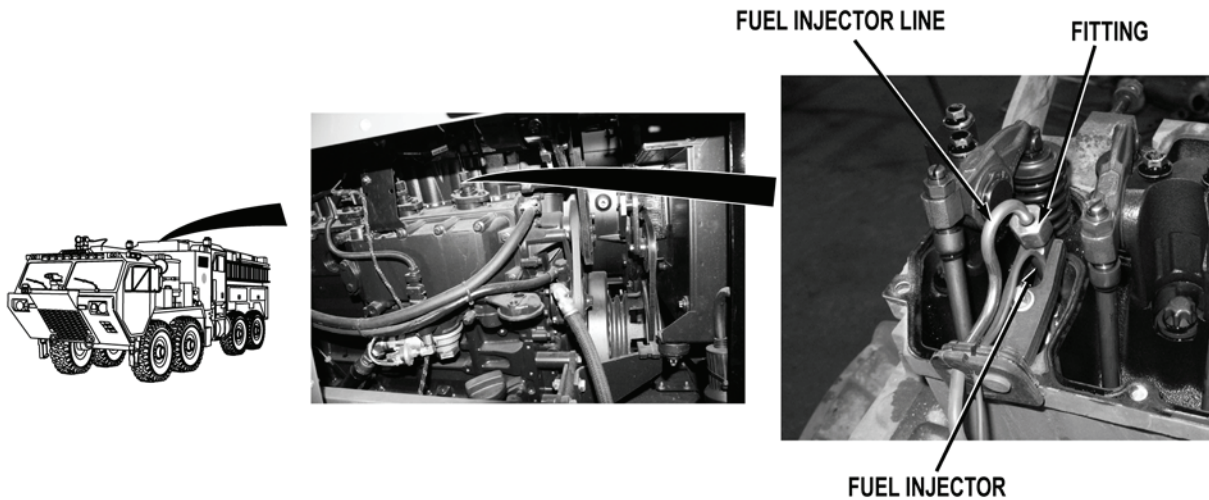

### NOTE

If water pump engine starts during Step 9, quickly turn START PUMP ENGINE STOP switch to STOP position and begin cranking engine again after engine is at a complete stop.

- Step 9. Remove water pump engine valve cover (WP 0251). While an assistant puts pump operator's panel START PUMP ENGINE STOP switch to START position (WP 0022), check for fuel leakage at each fuel injector line fitting.
- a. If there is fuel leakage at any fuel injector line, replace fuel injector line (WP 0233).
  - b. If there is no fuel leakage at any fuel injector, replace water pump engine (WP 0219).
- Step 10. Remove water pump engine fuel injectors (WP 0233). Perform injector nozzle pressure check (WP 0196).
- If fuel injector nozzle(s) do not pass pressure test, replace fuel injector(s) (WP 0233).
- Step 11. Perform water pump engine compression test (WP 0194). Check if water pump engine passes compression test.
- a. If water pump engine passes compression test, replace fuel injectors (WP 0233) and fuel injector lines (WP 0233).
  - b. If water pump engine does not pass compression test, replace water pump engine (WP 0219).

**END OF TASK**

**FOLLOW-ON MAINTENANCE**

Remove wheel chocks (TM 9-2320-347-10)

**END OF TASK**

**END OF WORK PACKAGE**

**FIELD LEVEL MAINTENANCE**

**WATER PUMP NOISY**

**INITIAL SETUP:**

**Tools and Special Tools**

Tool Kit, General Mechanic's: Automotive  
(WP 0622, Item 27)

**Equipment Conditions**

Water pump engine OFF (WP 0022)  
Engine OFF (TM 9-2320-347-10)  
Wheels chocked (TM 9-2320-347-10)

**References**

WP 0004  
WP 0023  
WP 0085  
WP 0186  
WP 0253  
WP 0255

**MALFUNCTION**

**TEST OR INSPECTION**

**CORRECTIVE ACTION**

**WATER PUMP NOISY**

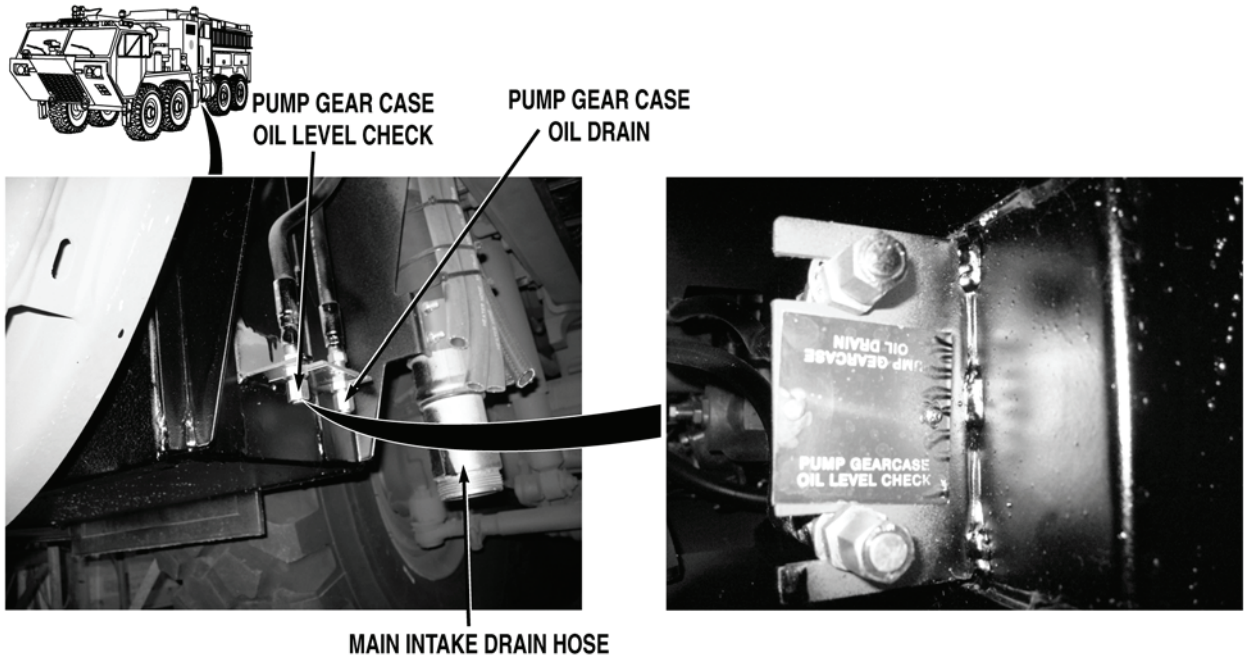

Step 1. Check water pump gear case oil level (WP 0253).

If oil level is low, fill to correct level (WP 0186) and go to Step 2.

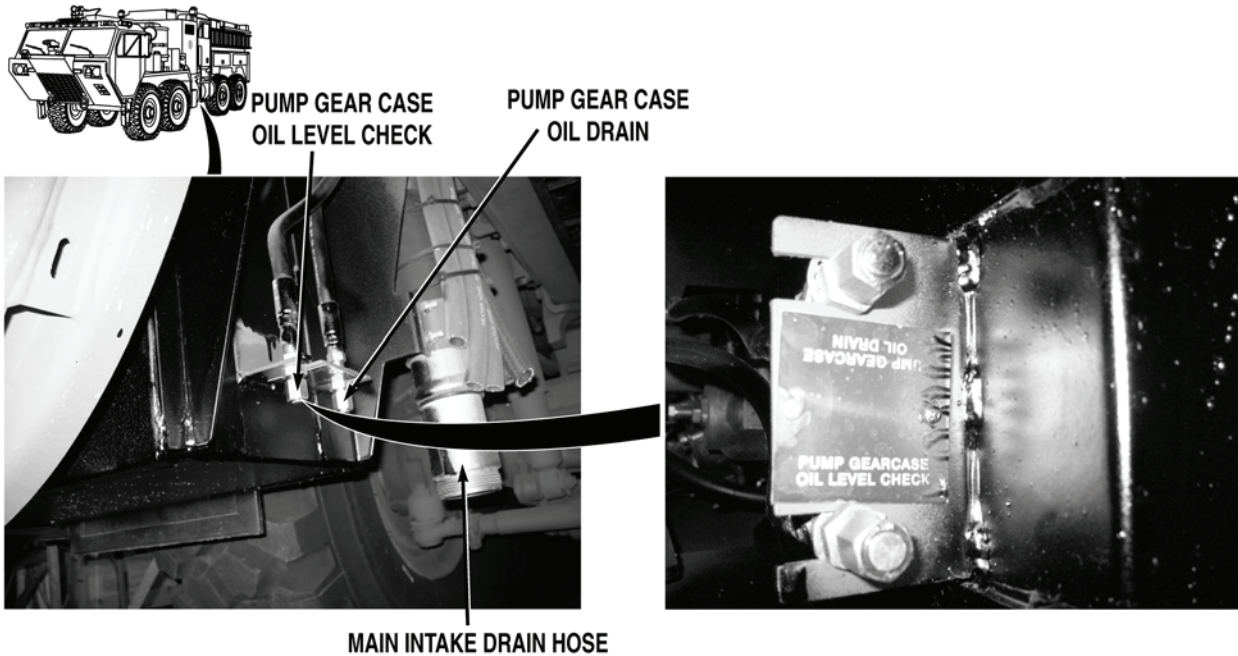
**MALFUNCTION****TEST OR INSPECTION****CORRECTIVE ACTION**

**⚠ CAUTION**

- Pump must be primed when operating water pump. Failure to prime pump before operating water pump may damage equipment.
- Tank fill & re-circulating line valve must be opened only slightly. If tank fill & re-circulating line valve is opened fully, water pump cavitation may occur causing damage to equipment.

- Step 2. Start engine (TM 9-2320-347-10). Perform setup for Pumping From Onboard Water Tank (WP 0085). Ensure pump is primed (WP 0023). Push pump operator's panel TANK FILL & RE-CIRCULATING LINE valve control OPEN button (WP 0004). Check if water pump is excessively noisy.
- If water pump is not excessively noisy, fault corrected.
  - If water pump is excessively noisy, replace water pump (WP 0255).

**END OF TASK****FOLLOW-ON MAINTENANCE**

Remove wheel chocks (TM 9-2320-347-10)

**END OF TASK****END OF WORK PACKAGE**

**FIELD LEVEL MAINTENANCE**

**WATER PUMP ENGINE OIL CONSUMPTION IS HIGH OR LEAKS OIL**

**Tools and Special Tools**

Tool Kit, General Mechanic's: Automotive  
(WP 0622, Item 27)

**References**

WP 0010  
WP 0244  
WP 0245  
WP 0246

**References (continued)**

WP 0247  
WP 0540  
WP 0479  
WP 0499

**Equipment Conditions**

Water pump engine OFF (WP 0022)  
Engine OFF (TM 9-2320-347-10)  
Wheels chocked (TM 9-2320-347-10)

**MALFUNCTION**

**TEST OR INSPECTION**

**CORRECTIVE ACTION**

**WATER PUMP ENGINE OIL CONSUMPTION IS HIGH OR LEAKS OIL**

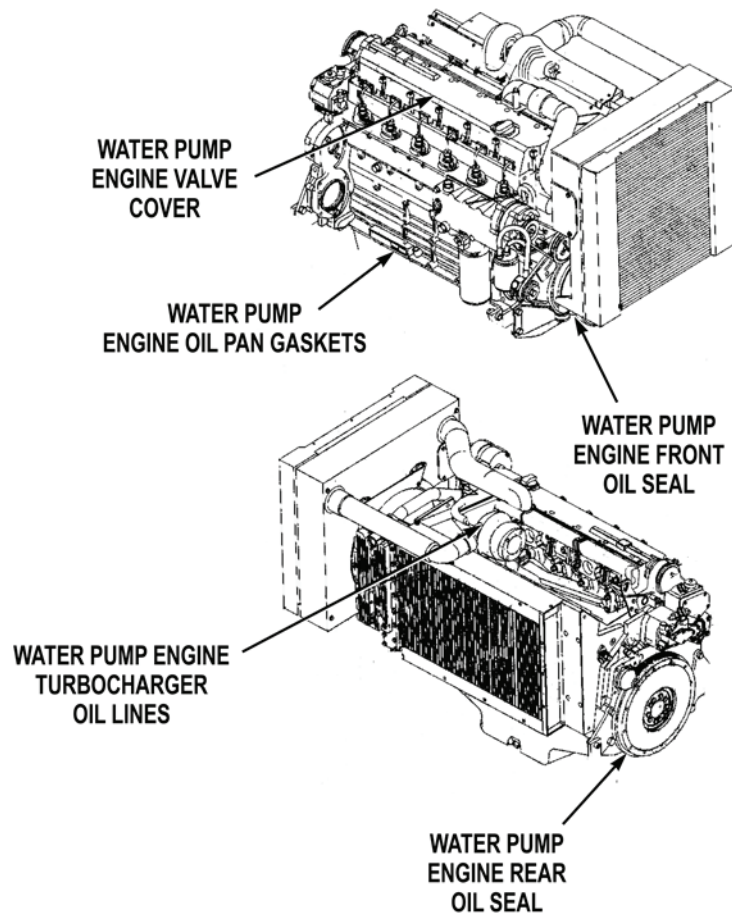
**MALFUNCTION****TEST OR INSPECTION****CORRECTIVE ACTION****NOTE**

If unable to determine where leak is, wash and run water pump engine to determine location of leak.

- Step 1. Check if water pump engine has visual oil leaks.
- a. If water pump engine shows signs of leaks, go to Step 2.
  - b. If water pump engine does not show signs of leaks, go to Step 6.
- Step 2. Remove passenger side crew cab access panel (WP 0499). Remove pump house panels G, O, T, and U (WP 0540). Check if water pump engine valve cover, front and rear oil seals, turbocharger oil lines, or oil pan gaskets leak.

If water pump engine valve cover, front and rear oil seals, turbocharger oil lines, or oil pan gaskets leak, notify Supervisor.

**MALFUNCTION**  
**TEST OR INSPECTION**  
**CORRECTIVE ACTION**

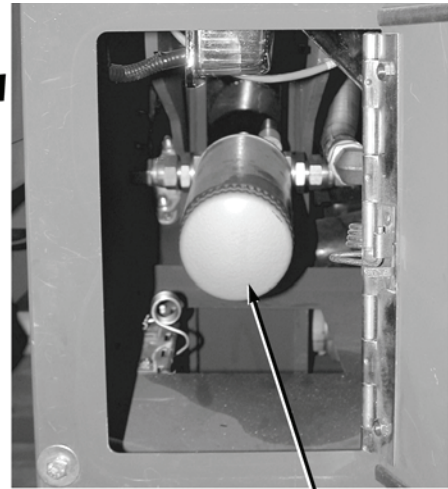
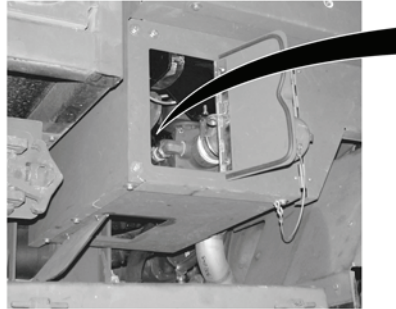
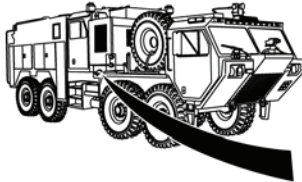

**WATER PUMP  
 ENGINE OIL  
 FILTER**

Step 3. Open pump house access panel on pump house panel M (WP 0010). Check if water pump engine oil filter is tight or damaged.

If water pump engine oil filter is not tight or is damaged, tighten or replace water pump engine oil filter (WP 0244).

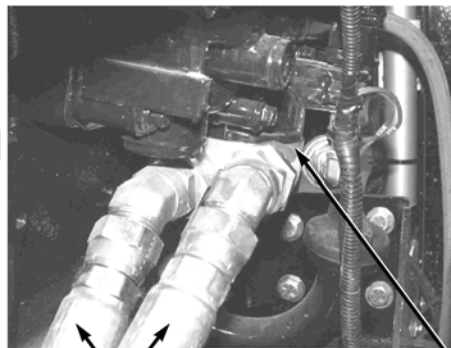

**WATER PUMP ENGINE  
 REMOTE OIL FILTER HOSES**

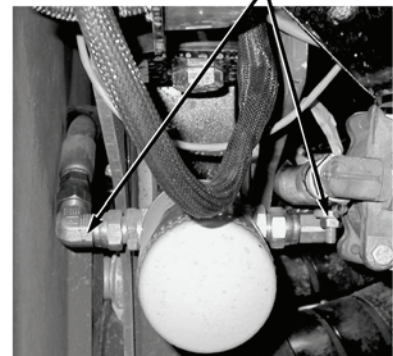

**WATER PUMP ENGINE  
 REMOTE OIL FILTER HEAD**

**WATER PUMP ENGINE  
 REMOTE OIL FILTER HOSES**

Step 4. Check if water pump engine remote oil filter head or water pump engine remote oil filter hoses are tight or are free from leaks or damage.

If water pump engine remote oil filter head or hoses are not tight or free from leaks or damage, tighten or replace oil filter head or hoses (WP 0247).

---

**MALFUNCTION****TEST OR INSPECTION****CORRECTIVE ACTION**

---

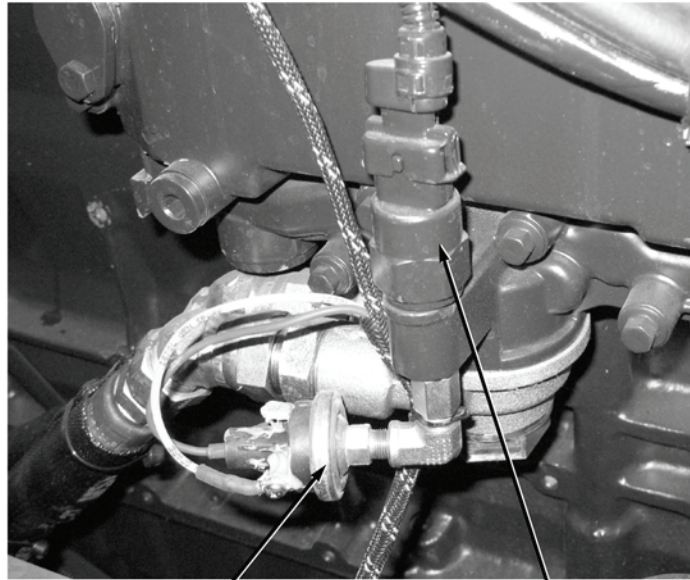
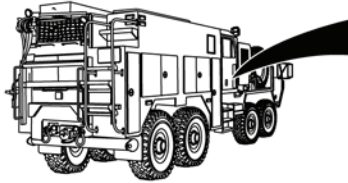

WATER PUMP ENGINE OIL  
PRESSURE SWITCH

WATER PUMP ENGINE OIL  
PRESSURE SENDING UNIT

- Step 5. Check if water pump engine oil pressure switch or water pump engine oil pressure sending unit leaks.
- a. If water pump engine oil pressure switch leaks, replace water pump engine oil pressure switch (WP 0246).
  - b. If water pump engine oil pressure sending unit leaks, replace water pump engine oil pressure sending unit (WP 0245).

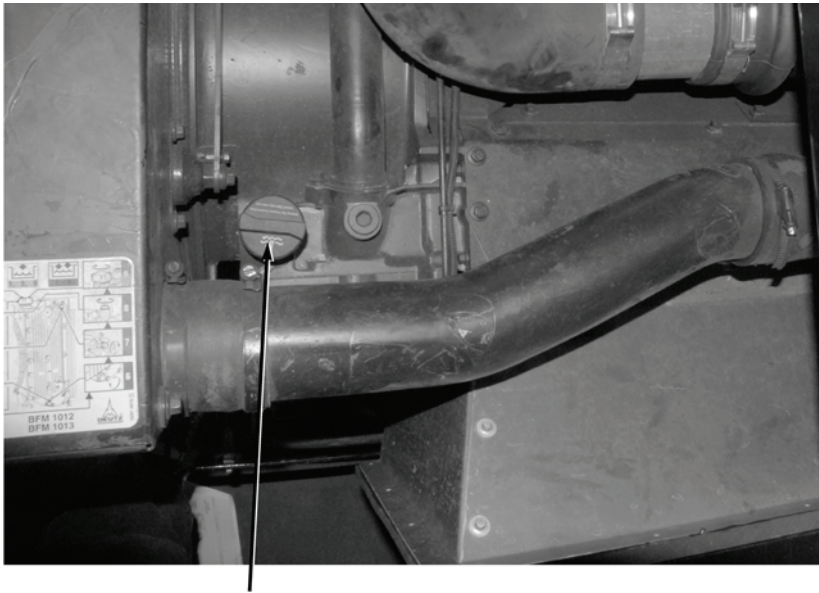
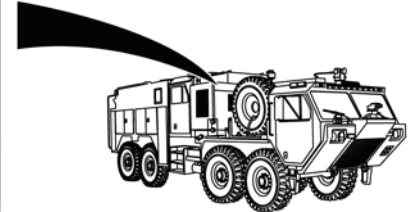

**MALFUNCTION****TEST OR INSPECTION****CORRECTIVE ACTION****RADIATOR CAP****WARNING**

**Allow engine to completely cool before handling any cooling system component or hose. Failure to comply can result in serious injury to personnel.**

- Step 6. Remove radiator cap (WP 0479). Check if water pump engine coolant shows signs of oil contamination.
- If water pump engine coolant show signs of contamination, notify Supervisor.
  - If water pump engine coolant does not show signs of contamination, notify Supervisor.

**END OF TASK****FOLLOW-ON MAINTENANCE**

- Install pump house panel G, O, T, and U if removed (WP 0540)
- Remove wheel chocks (TM 9-2320-347-10)

**END OF TASK****END OF WORK PACKAGE**



---

**FIELD LEVEL MAINTENANCE**
**WATER PUMP ENGINE OIL PRESSURE IS LOW**

---

**INITIAL SETUP:****Tools and Special Tools**

Lead Set, Test (WP 0622, Item 21)  
 Tool Kit, General Mechanic's: Automotive  
 (WP 0622, Item 27)

**References**

TM 9-2320-325-14&P  
 WP 0004  
 WP 0007  
 WP 0010  
 WP 0022  
 WP 0146  
 WP 0149  
 WP 0186

**References (continued)**

WP 0226  
 WP 0243  
 WP 0245  
 WP 0464  
 WP 0499  
 WP 0540

**Equipment Conditions**

Water pump engine OFF (WP 0022)  
 Engine OFF (TM 9-2320-347-10)  
 Wheels chocked (TM 9-2320-347-10)

---

**MALFUNCTION**
**TEST OR INSPECTION****CORRECTIVE ACTION**

---

**WATER PUMP ENGINE OIL PRESSURE IS LOW**

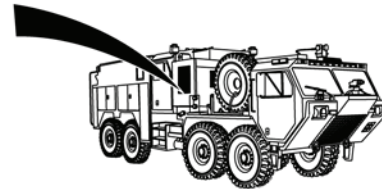
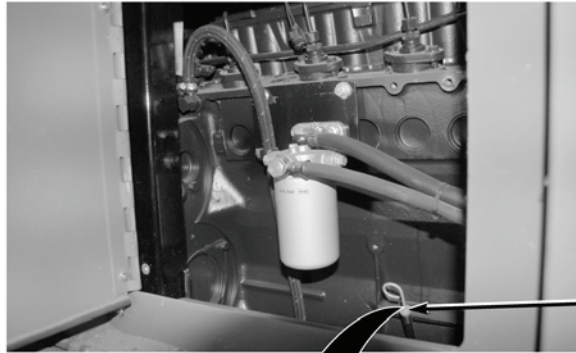
**MALFUNCTION****TEST OR INSPECTION****CORRECTIVE ACTION**

**WATER PUMP ENGINE  
OIL LEVEL DIPSTICK**



**FULL MARK**

**ADD MARK**

** CAUTION**

**Water pump engine oil is at proper level when oil is between full and add marks on oil level dipstick. Failure to comply may result in damage to equipment.**

**NOTE**

Water pump engine must be stopped for at least five minutes before oil level can be checked accurately.

- Step 1. Check if water pump engine oil level is between full and add marks (WP 0186) on water pump engine oil level dipstick.

If water pump engine oil level is not between full and add marks, drain or fill engine oil to achieve proper level as needed (WP 0243).

**MALFUNCTION**  
**TEST OR INSPECTION**  
**CORRECTIVE ACTION**

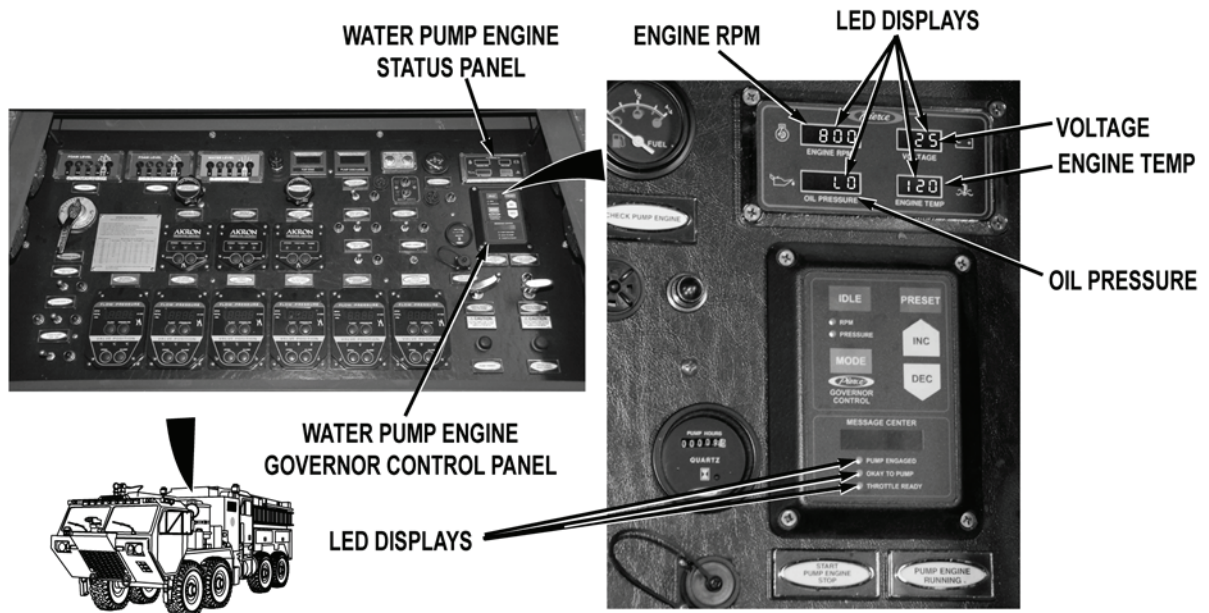

Step 2. Turn battery disconnect switch to ON position (WP 0007). Start water pump engine (WP 0022). Check if any water pump engine governor control panel or engine status panel display LED indicators illuminate (WP 0004).

If water pump governor control panel and engine status panel do not illuminate, troubleshoot Water Pump Engine Pressure Governor Control Panel Does Not Operate Properly (WP 0146).

Step 3. Check if water pump engine status panel displays ENGINE RPM, VOLTAGE, ENGINE TEMP, and OIL PRESSURE (WP 0004).

If water pump engine status panel does not display ENGINE RPM, VOLTAGE, ENGINE TEMP, and OIL PRESSURE troubleshoot Water Pump Engine Gauge Panel Does Not Operate Properly (WP 0149).

## MALFUNCTION

## TEST OR INSPECTION

## CORRECTIVE ACTION

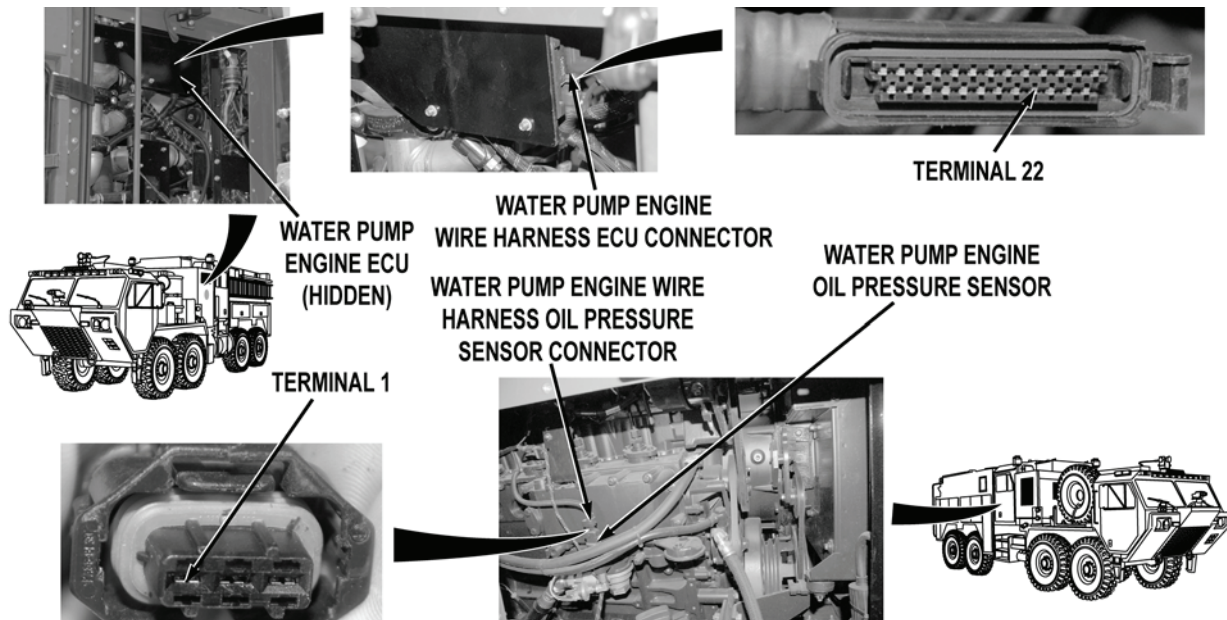
**WARNING**

Remove rings, wristwatches, neck chains, and any other jewelry before working around vehicle. Jewelry can catch on equipment and cause serious injury. Jewelry and tools may short across electrical circuits and cause damage to equipment, or severe burns or electrical shock to personnel.

**CAUTION**

- Wires contained in water pump engine wire harness are black and have no identifying numbers. It will be necessary to use connector terminal numbers described in text and pictures to identify correct wire. Failure to comply may cause damage to equipment.
- Do not force test probes into water pump engine wire harness connectors. Failure to comply will cause damage to equipment.

Step 4. Stop water pump engine (WP 0022). Turn battery disconnect switch to OFF position (WP 0007). Remove driver and passenger side crew cab access panel (WP 0499). Remove pump house panel O and Q (WP 0540). Disconnect water pump engine wire harness oil pressure sensor connector. Disconnect water pump engine wire harness ECU connector. With a test lead set, check for continuity across wire from water pump engine wire harness oil pressure sensor connector, terminal 1 to water pump engine wire harness ECU connector, terminal 22.

If there is no continuity, go to Step 10.

---

**MALFUNCTION**  
**TEST OR INSPECTION**  
**CORRECTIVE ACTION**

---

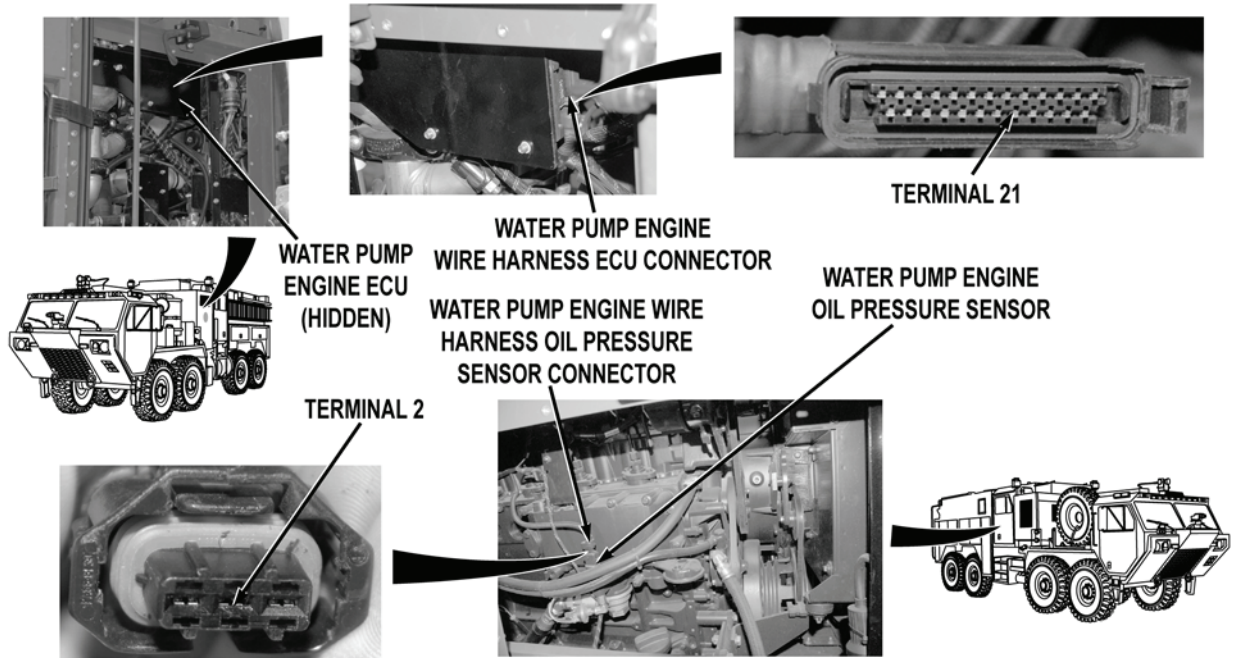

Step 5. Check for continuity across wire from water pump engine wire harness oil pressure sensor connector, terminal 2 to water pump engine wire harness ECU connector, terminal 21.

If there is no continuity, go to Step 9.

**MALFUNCTION**

**TEST OR INSPECTION**

**CORRECTIVE ACTION**

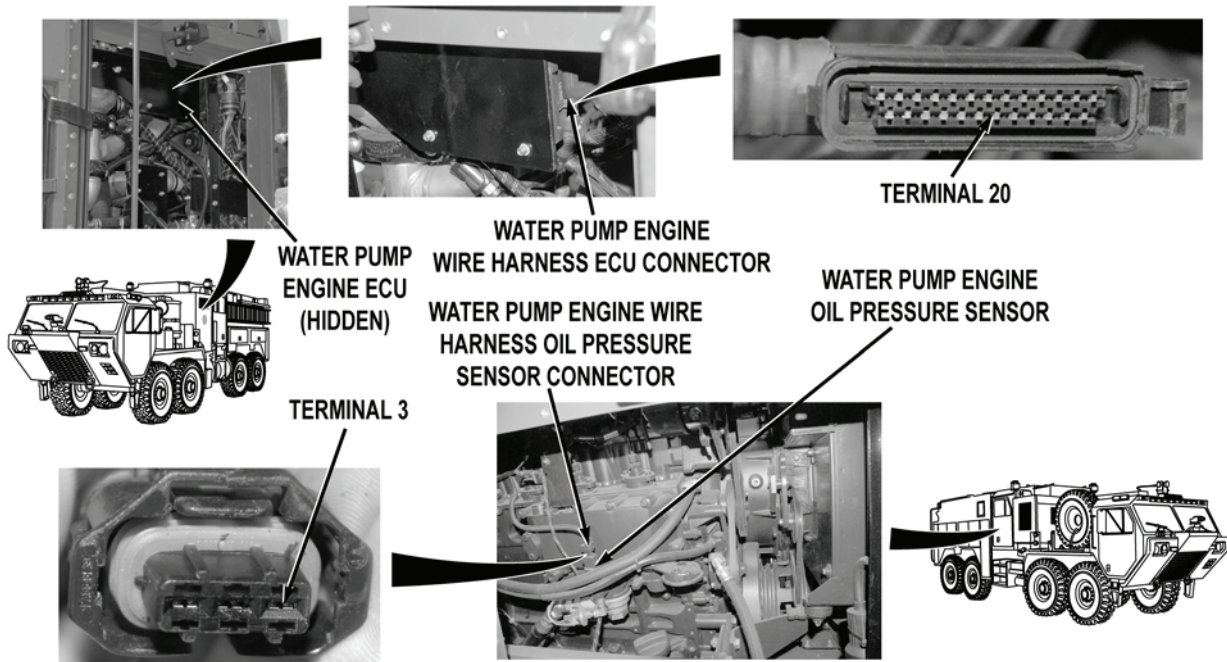

Step 6. Check for continuity across wire from water pump engine wire harness oil pressure sensor connector, terminal 3 to water pump engine wire harness ECU connector, terminal 20.

If there is continuity, go to Step 8.



---

**MALFUNCTION**  
**TEST OR INSPECTION**  
**CORRECTIVE ACTION**

---

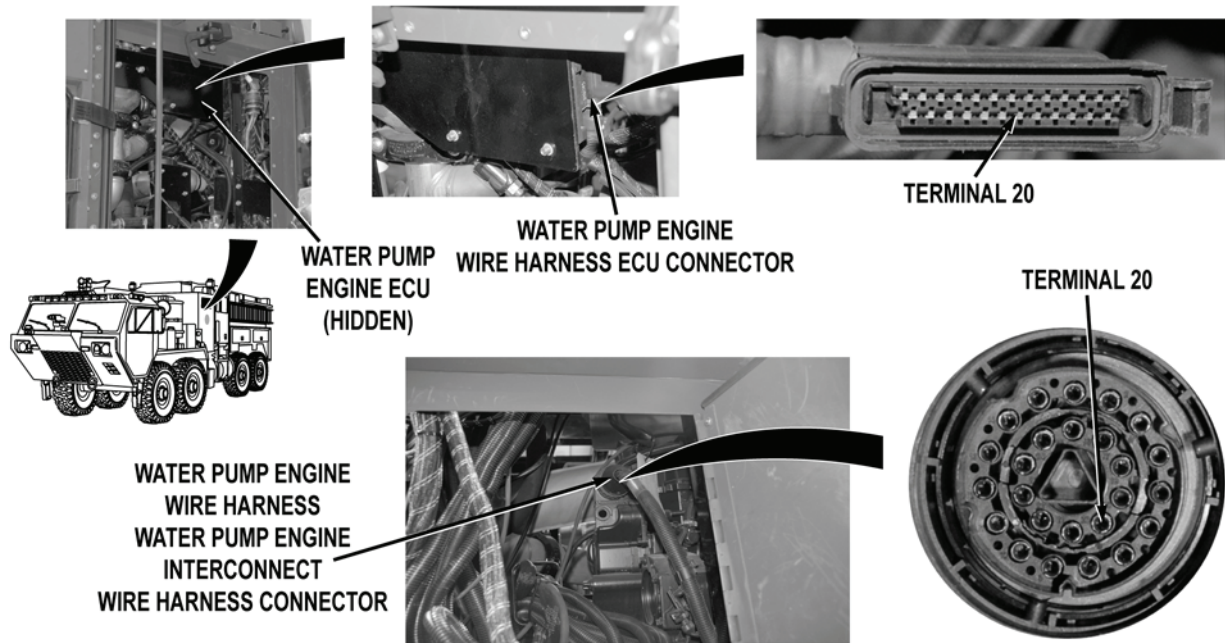

Step 7. Open driver side pump house access door (WP 0010). Disconnect water pump engine wire harness water pump engine interconnect wire harness connector. With a test lead set, check for continuity across water pump engine interconnect wire harness, wire from water pump engine wire harness ECU connector terminal 20, to water pump engine wire harness water pump engine interconnect wire harness connector, terminal 20.

- a. If there is continuity, replace water pump engine wire harness (WP 0464).
- b. If there is no continuity, replace water pump engine interconnect wire harness (WP 0464).

Step 8. Connect water pump engine wire harness oil pressure sensor connector. Connect water pump engine wire harness control unit connector. Remove water pump engine oil pressure switch (WP 0246). Install pressure transducer TK Item 17. Connect P1 of cable W4 to J2 or J3 connectors on VTM. Connect P2 of W4 cable to pressure transducer. Do STE/ICE oil pressure test 35 (TM 9-2320-325-14&P). Check if water pump engine oil pressure is above 10 psi (69 kPa).

- a. If water pump engine status panel oil pressure is above 10 psi (69 kPa), replace water pump engine oil pressure sensor (WP 0245).
- b. If water pump engine status panel does indicate oil pressure is below 10 psi (69 kPa), replace water pump engine (WP 0219).

**MALFUNCTION**

**TEST OR INSPECTION**

**CORRECTIVE ACTION**

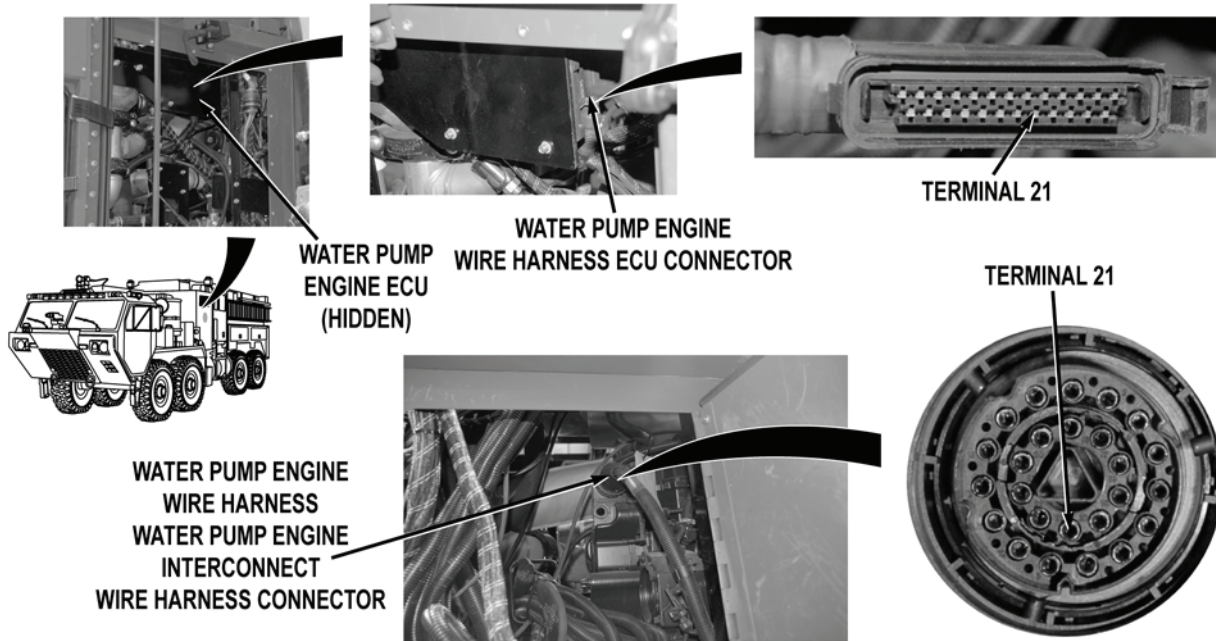

- Step 9. Open driver side pump house access door (WP 0010). Disconnect water pump engine wire harness water pump engine interconnect wire harness connector. With a test lead set, check for continuity across water pump engine interconnect wire harness, wire from water pump engine wire harness ECU connector, terminal 21 to water pump engine wire harness water pump engine interconnect wire harness connector, terminal 21.
- a. If there is continuity, replace water pump engine wire harness (WP 0464).
  - b. If there is no continuity, replace water pump engine interconnect wire harness (WP 0464).

**MALFUNCTION**  
**TEST OR INSPECTION**  
**CORRECTIVE ACTION**

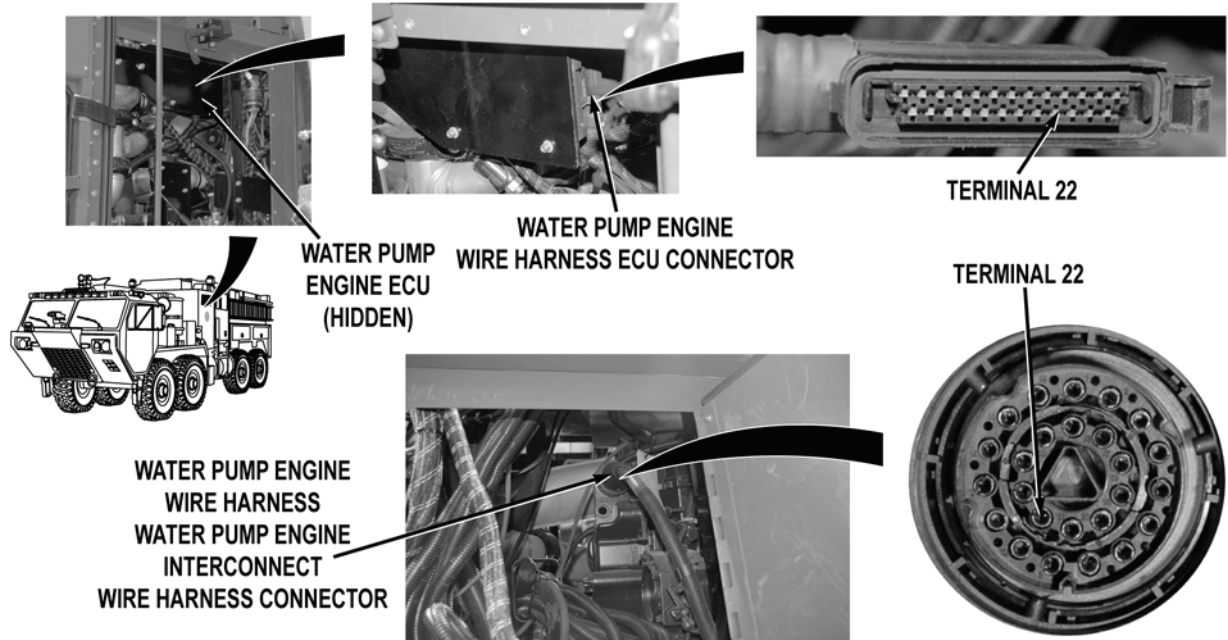

- Step 10. Open driver side pump house access door (WP 0010). Disconnect water pump engine wire harness water pump engine interconnect wire harness connector. With a test lead set, check for continuity across water pump engine interconnect wire harness, wire from water pump engine wire harness ECU connector, terminal 22 to water pump engine wire harness water pump engine interconnect wire harness connector, terminal 22.
- a. If there is continuity, replace water pump engine wire harness (WP 0464).
  - b. If there is no continuity, replace water pump engine interconnect wire harness (WP 0464).

**END OF TASK**

**FOLLOW-ON MAINTENANCE**

1. Install driver and passenger side crew cab access panel (WP 0499)
2. Install pump house panel O and Q (WP 0540)
3. Remove wheel chocks (TM 9-2320-347-10)

**END OF TASK**

**END OF WORK PACKAGE**



**FIELD LEVEL MAINTENANCE**

**WATER PUMP ENGINE OVERHEATS**

**INITIAL SETUP:**

**Tools and Special Tools**

Tool Kit, General Mechanic's: Automotive  
(WP 0622, Item 27)

**References**

WP 0219  
WP 0230  
WP 0243  
WP 0249  
WP 0476

**References (continued)**

WP 0478  
WP 0481  
WP 0499  
WP 0540

**Equipment Conditions**

Water pump engine OFF (WP 0022)  
Engine OFF (TM 9-2320-347-10)  
Wheels chocked (TM 9-2320-347-10)

**MALFUNCTION**

**TEST OR INSPECTION**

**CORRECTIVE ACTION**

**WATER PUMP ENGINE OVERHEATS**

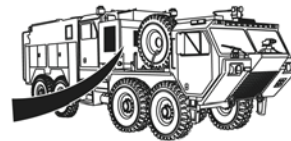
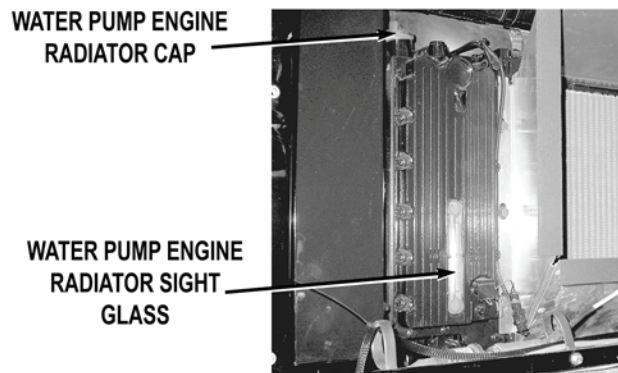

**WARNING**



**Allow engine to completely cool before handling any cooling system component or hose. Failure to comply can result in serious injury to personnel.**

- Step 1. Remove pump house panel G (WP 0540). Remove water pump engine radiator cap. Check coolant level in water pump engine radiator sight glass.

If water pump engine coolant level is at proper level, go to Step 7.

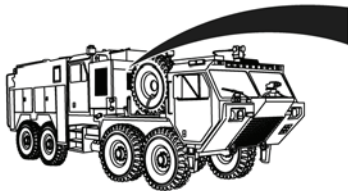
**MALFUNCTION****TEST OR INSPECTION****CORRECTIVE ACTION**UPPER COOLANT  
TUBETHERMOSTAT  
HOUSING

- Step 2. Remove passenger side crew cab access panel (WP 0499). Remove pump house panel O (WP 0540). Perform water pump engine cooling system pressure check (WP 0478). Check if thermostat housing and upper coolant tube are free from leaks or damage.

If thermostat housing and upper coolant tube are not free from leaks or damage, replace damaged thermostat housing or upper coolant tube (WP 0249).

- Step 3. Remove pump house panel U (WP 0540). With cooling system pressure tester still installed and pressurized (WP 0478), check coolant hose and tubes for leaks or damage.

If coolant hose or tubes are not free from leaks or damage, tighten or replace leaking or damaged hose or tubes (WP 0476).

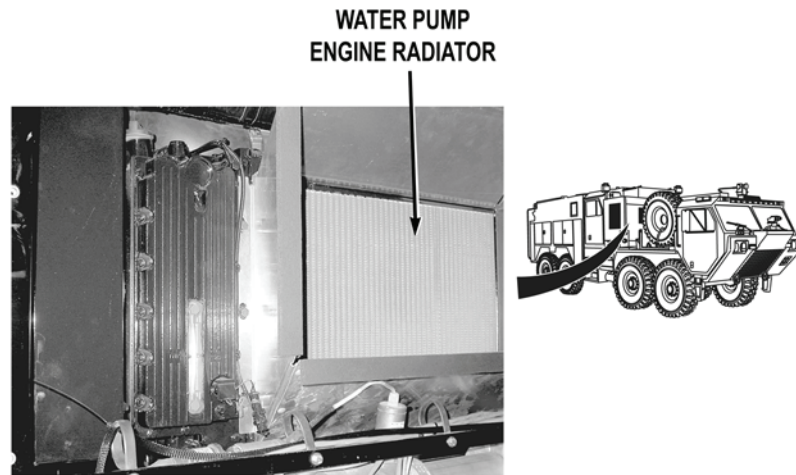
**MALFUNCTION****TEST OR INSPECTION****CORRECTIVE ACTION**

- Step 4. With cooling system pressure tester still installed and pressurized (WP 0478), check water pump engine radiator for leaks or damage.

If water pump engine radiator is not free from leaks or damage, replace water pump engine radiator (WP 0481).

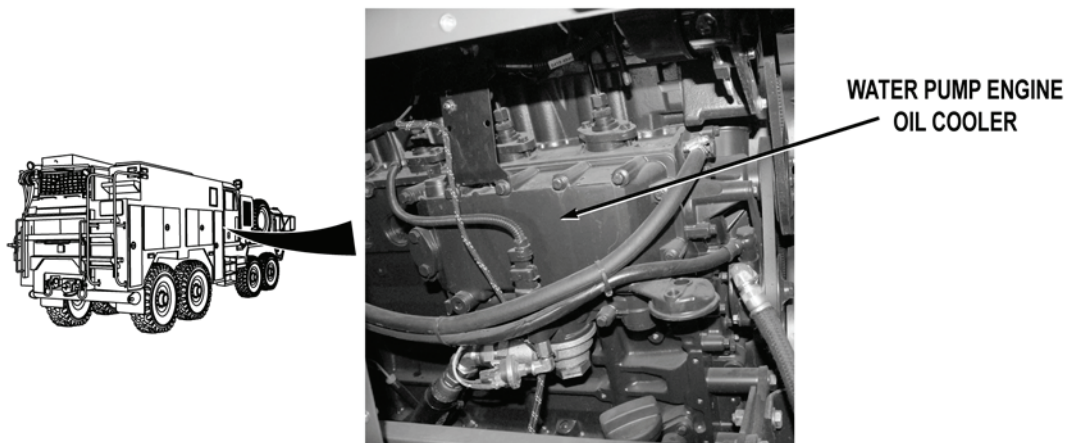

- Step 5. With cooling system pressure tester still installed and pressurized (WP 0478), check if water pump engine oil cooler leaks.

If water pump engine oil cooler leaks, notify Supervisor.

---

**MALFUNCTION****TEST OR INSPECTION****CORRECTIVE ACTION**

---



**WATER PUMP ENGINE  
OIL LEVEL DIPSTICK**



**FULL MARK**

**ADD MARK**

**NOTE**

Coolant in engine oil will sometimes give engine oil a milky appearance.

- Step 6. Remove water pump engine oil level dipstick (WP 0243). Inspect water pump engine oil level dipstick for signs of coolant or oil level above oil dipstick full mark.
- a. If oil shows signs of coolant or oil level is above oil dipstick full mark, replace water pump engine (WP 0219).
  - b. If oil does not show sign of coolant and oil level is below add mark, fill oil to proper level.

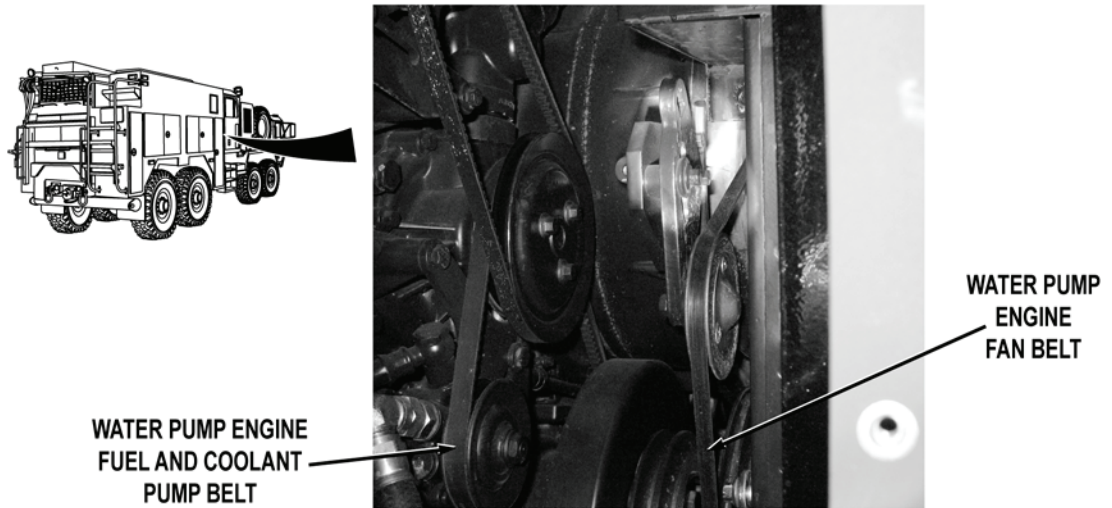

**MALFUNCTION****TEST OR INSPECTION****CORRECTIVE ACTION**

- Step 7. Remove passenger side crew cab access panel (WP 0499). Remove pump house panel O (WP 0540). Check if water pump engine fan belt is tight and free from damage.

If water pump engine fan belt is not tight or free from damage, tighten or replace water pump engine fan belt (WP 0230).

- Step 8. Check if water pump engine fuel and coolant pump belt is tight and free from damage.

If water pump engine fuel and coolant belt is not tight or free from damage, tighten or replace water pump engine fuel and coolant belt (WP 0230).

---

**MALFUNCTION****TEST OR INSPECTION****CORRECTIVE ACTION**

---

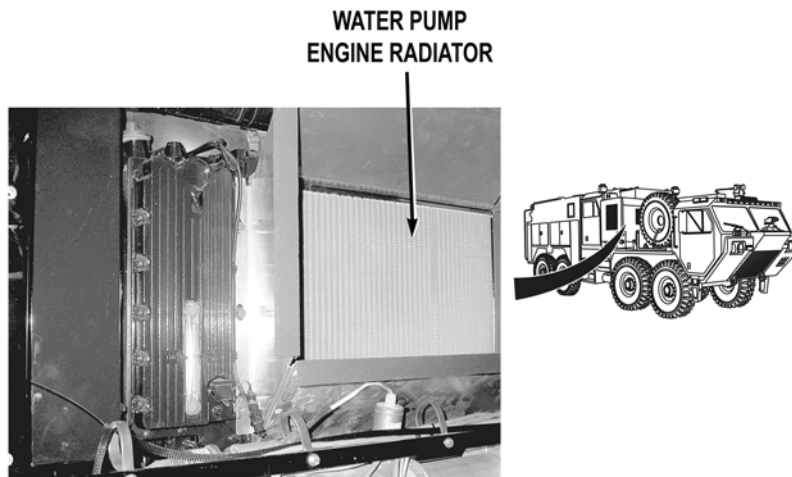

Step 9. Check if water pump engine radiator is free from blockage.

- a. If water pump engine radiator is free from blockage, replace water pump engine radiator (WP 0481).
- b. If water pump engine radiator is not free from blockage, clean water pump engine radiator fins.

**END OF TASK**

**FOLLOW-ON MAINTENANCE**

Install pump house panels G, O, U (WP 0540)

**END OF TASK**

**END OF WORK PACKAGE**

---

**FIELD LEVEL MAINTENANCE**

**FOAM NOT DELIVERED FROM ALL SYSTEMS (BUMPER TURRET, GROUND SWEEPS, AND MANUAL METERING CONTROLS) OR SYSTEM DOES NOT SHUT OFF**

---

**INITIAL SETUP:****Tools and Special Tools**

Drain Pan (WP 0622, Item 9)  
 Lead Set, Test (WP 0622, Item 21)  
 Tool Kit, General Mechanic's: Automotive  
 (WP 0622, Item 27)

**Personnel Required**

MOS 63B Wheeled vehicle mechanic (2)

**References**

TM 9-2320-325-14&P  
 WP 0004  
 WP 0007  
 WP 0019  
 WP 0287  
 WP 0290  
 WP 0311  
 WP 0315  
 WP 0325  
 WP 0330

**References (continued)**

WP 0401  
 WP 0402  
 WP 0426  
 WP 0427  
 WP 0441  
 WP 0443  
 WP 0455  
 WP 0459  
 WP 0499  
 WP 0463  
 WP 0539  
 WP 0540  
 WP 0550  
 WP 0567

**Equipment Conditions**

Water pump engine OFF (WP 0022)  
 Engine OFF (TM 9-2320-347-10)  
 Wheels chocked (TM 9-2320-347-10)

---

**MALFUNCTION****TEST OR INSPECTION****CORRECTIVE ACTION**

---

**FOAM NOT DELIVERED FROM ALL SYSTEMS (BUMPER TURRET, GROUND SWEEPS, AND MANUAL METERING CONTROLS) OR SYSTEM DOES NOT SHUT OFF**

**NOTE**

- Ensure system air pressure is at least 85 psi (586 kPa) during this procedure. System air pressure is required to activate valves.
- Do not engage water pump engine during this procedure, except when performing complete system checks. Valve operations can be checked without water pump operation.
- Valve operations can be checked by observing valve shaft rotation. Valves are open when tabs or yellow paint tabs are aligned with direction of fluid flow.

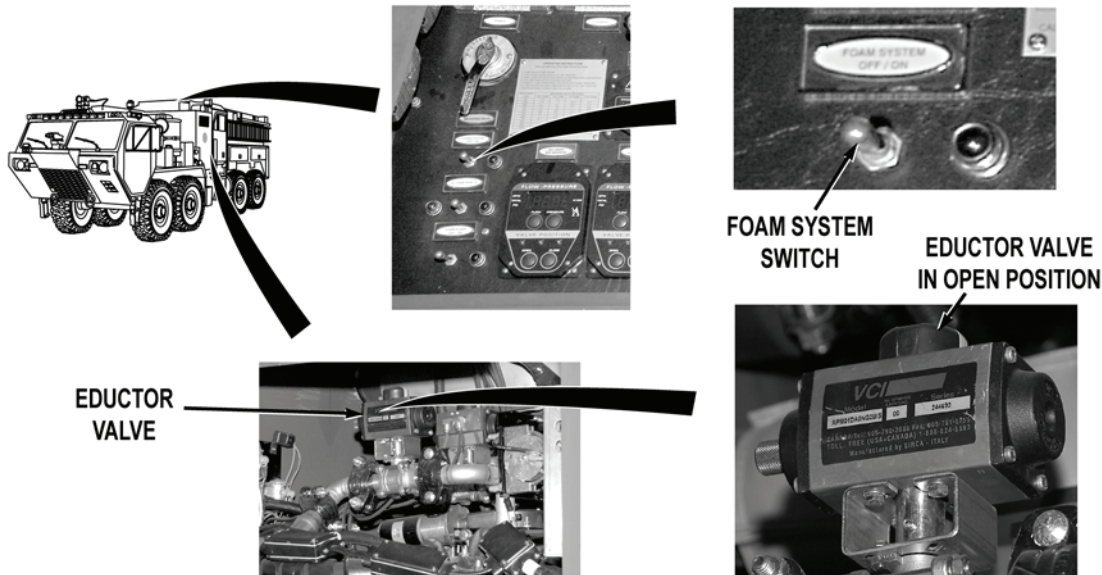
**MALFUNCTION****TEST OR INSPECTION****CORRECTIVE ACTION**

Step 1. Turn battery disconnect switch to ON position (WP 0007). If system air pressure is below 85 psi (586 kPa), start engine and allow system air pressure to build to at least 85 psi (586 kPa) (TM 9-2320-347-10). Shut off engine (TM 9-2320-347-10). Open pump house panel A (WP 0539). Open pump operator's panel (WP 0019). While an assistant puts and holds pump operator's panel FOAM SYSTEM switch to ON position (WP 0004), check if eductor valve operates to open position.

If eductor valve does not operate to open position, go to Step 22.

Step 2. Check if eductor valve remains in open position when assistant releases pump operator's panel FOAM SYSTEM switch (WP 0004).

If eductor valve does not remain in open position, go to Step 16.

Step 3. While an assistant puts pump operator's panel FOAM SYSTEM switch to OFF position (WP 0004), check if eductor valve operates to closed position.

If eductor valve does not operate to closed position, go to Step 10.

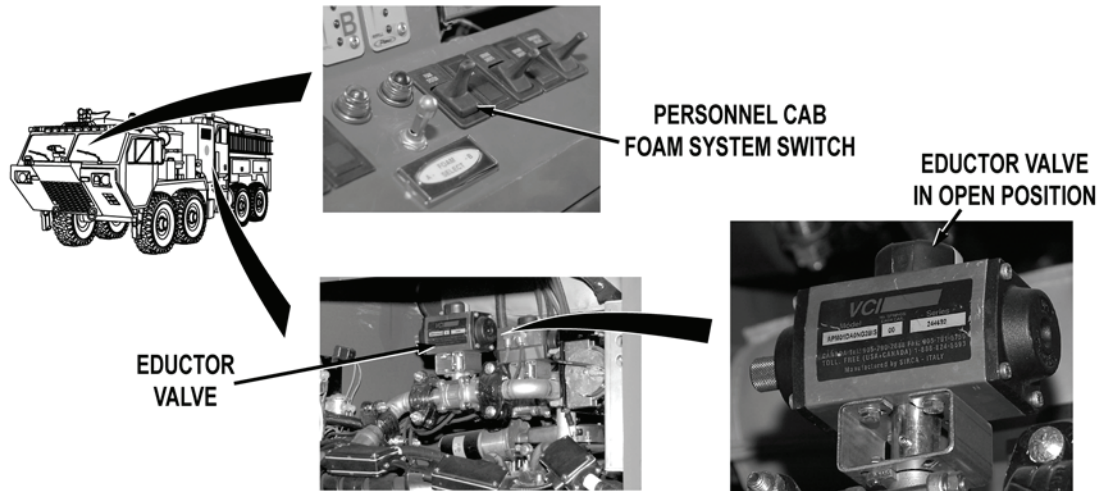
**MALFUNCTION****TEST OR INSPECTION****CORRECTIVE ACTION**

- Step 4. While an assistant puts personnel cab FOAM SYSTEM switch to on position (WP 0004), check if eductor valve operates to open position.

If eductor valve does not operate to open position, go to Step 8.

- Step 5. While an assistant puts personnel cab FOAM SYSTEM switch to off position (WP 0004), check if eductor valve operates to closed position.

If eductor valve does not operate to closed position, go to Step 7.

---

**MALFUNCTION****TEST OR INSPECTION****CORRECTIVE ACTION**

---

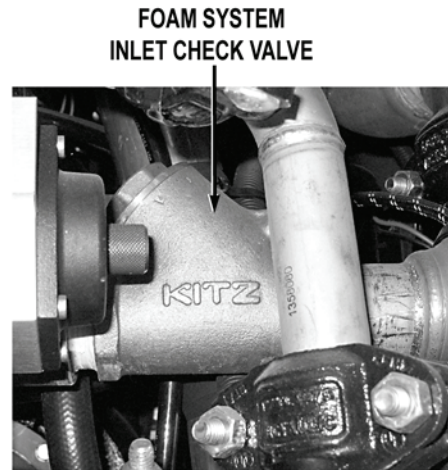
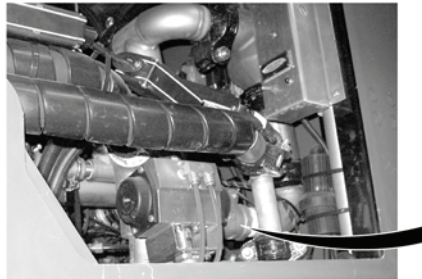
**NOTE**

Foam agent and water may leak from system when foam system inlet check valve is removed from vehicle. Place suitable container or drain pan under check valve and eductor before performing Step 6.

- Step 6. Turn battery disconnect switch to OFF position (WP 0007). Remove foam system inlet check valve (WP 0290). Check if foam system inlet check valve is free from blockage and damage.
- a. If foam system inlet check valve is blocked or damaged, remove blockage or replace damaged foam system inlet check valve (WP 0290).
  - b. If foam system inlet check valve is not blocked or damaged, replace eductor valve (WP 0287).

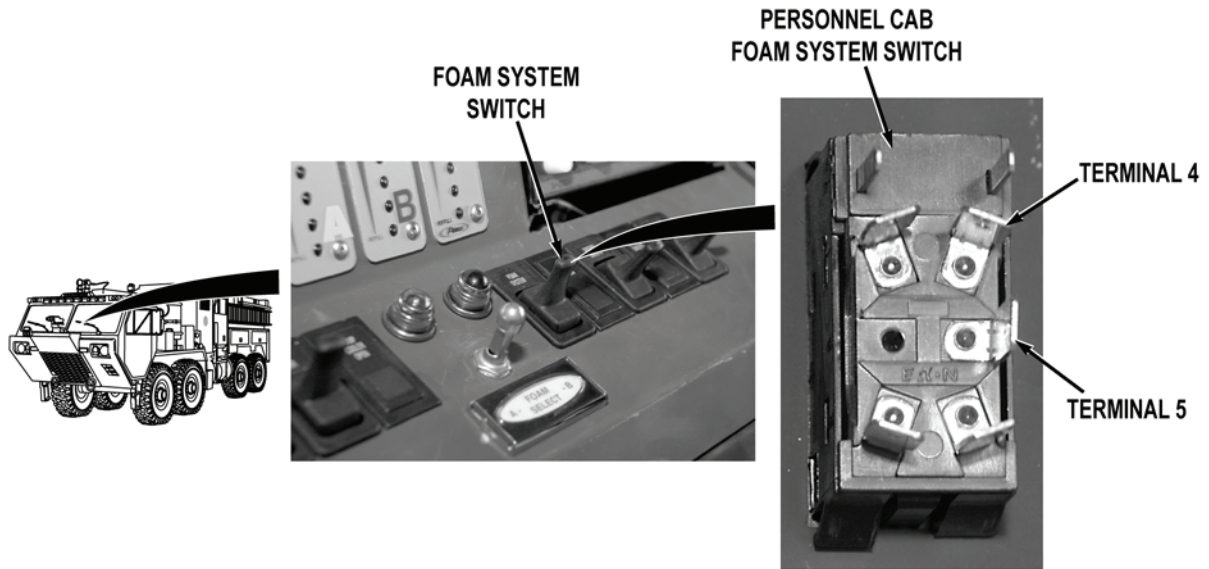
**MALFUNCTION****TEST OR INSPECTION****CORRECTIVE ACTION****WARNING**

**Remove rings, wristwatches, neck chains, and any other jewelry before working around vehicle. Jewelry can catch on equipment and cause serious injury. Jewelry and tools may short across electrical circuits and cause damage to equipment, or severe burns or electrical shock to personnel.**

- Step 7. Turn battery disconnect switch to OFF position (WP 0007). Remove personnel cab instrument panel B (WP 0311). Disconnect cab pump control wire harness FOAM SYSTEM switch connector. While an assistant holds personnel cab FOAM SYSTEM switch to off position (WP 0004), check for continuity across FOAM SYSTEM switch from terminal 4 to terminal 5.
- a. If there is continuity, repair wire 2831 (blue) in cab pump control wire harness if repairable (TM 9-2320-325-14&P), or replace cab pump control wire harness (WP 0443).
  - b. If there is no continuity, replace personnel cab FOAM SYSTEM switch (WP 0315).

## MALFUNCTION

## TEST OR INSPECTION

## CORRECTIVE ACTION

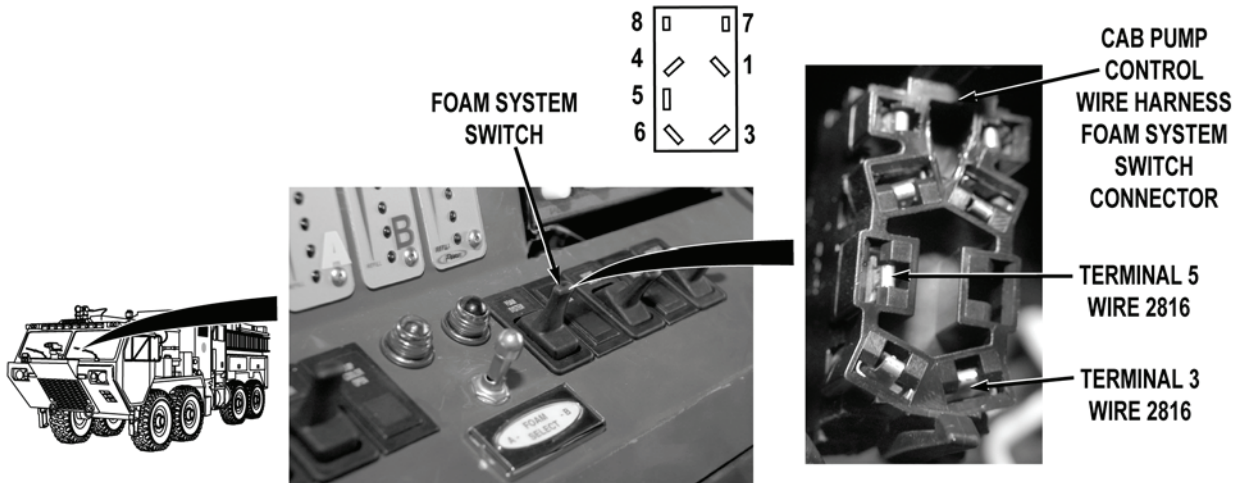
**WARNING**

**Remove rings, wristwatches, neck chains, and any other jewelry before working around vehicle. Jewelry can catch on equipment and cause serious injury. Jewelry and tools may short across electrical circuits and cause damage to equipment, or severe burns or electrical shock to personnel.**

- Step 8. Turn battery disconnect switch to OFF position (WP 0007). Remove personnel cab instrument panel B (WP 0311). Disconnect cab pump control wire harness FOAM SYSTEM switch connector. Turn battery disconnect switch to ON position (WP 0007). Check for 22 to 28 VDC between wire 2816 (red) from cab pump control wire harness FOAM SYSTEM switch connector, terminals 3 and 5 to a known good ground.

If 22 to 28 VDC are not present, repair wire 2816 in cab pump control wire harness if repairable (TM 9-2320-325-14&P), or replace cab pump control wire harness (WP 0443).



---

MALFUNCTION	TEST OR INSPECTION	CORRECTIVE ACTION
-------------	--------------------	-------------------

---

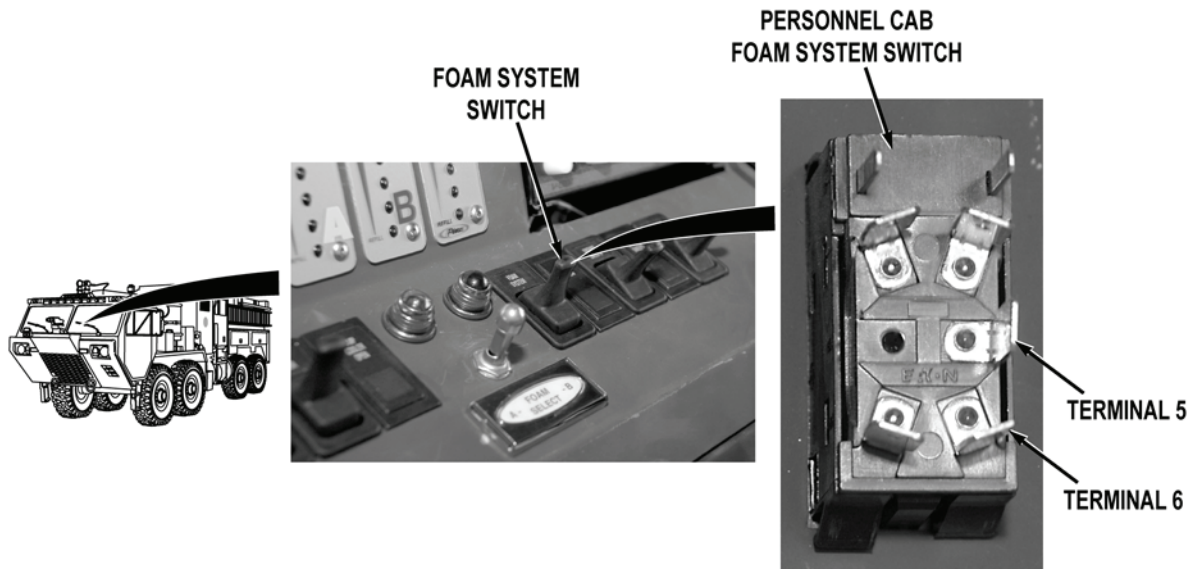

- Step 9. Turn battery disconnect switch to OFF position (WP 0007). While an assistant holds personnel cab FOAM SYSTEM switch to on position (WP 0007), check for continuity across FOAM SYSTEM switch from terminal 5 to terminal 6.
- If there is continuity, repair wire 2830 (red) in cab pump control wire harness if repairable (TM 9-2320-325-14&P), or replace cab pump control wire harness (WP 0443).
  - If there is no continuity, replace personnel cab FOAM SYSTEM switch (WP 0315).

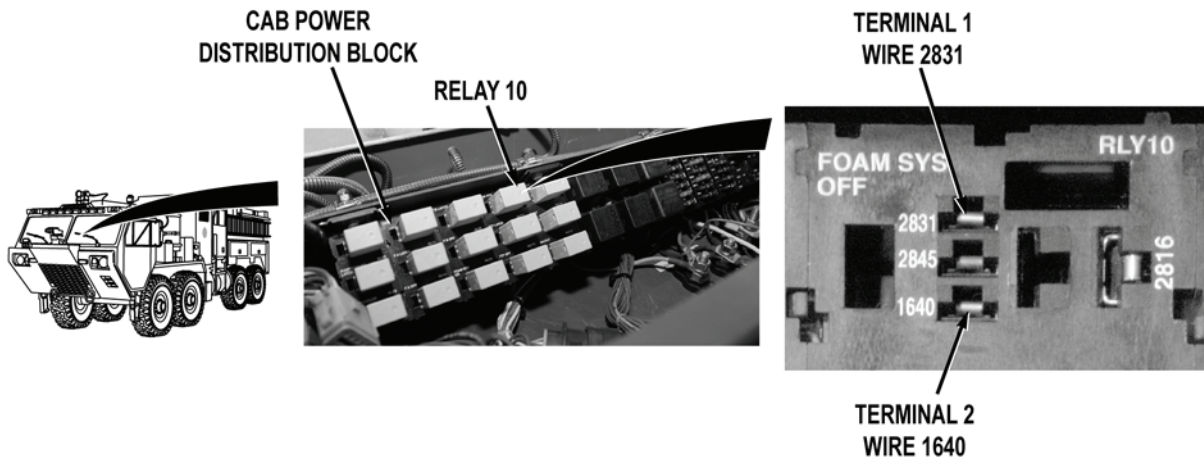
**MALFUNCTION****TEST OR INSPECTION****CORRECTIVE ACTION****WARNING**

**Remove rings, wristwatches, neck chains, and any other jewelry before working around vehicle. Jewelry can catch on equipment and cause serious injury. Jewelry and tools may short across electrical circuits and cause damage to equipment, or severe burns or electrical shock to personnel.**

- Step 10. Turn battery disconnect switch to OFF position (WP 0007). Remove personnel cab instrument panel A (WP 0311). Remove relay 10 from cab power distribution block (WP 0402). Turn battery disconnect switch to ON position (WP 0007). While an assistant holds pump operator's panel FOAM SYSTEM switch to OFF position (WP 0004), check for 22 to 28 VDC between wire 2831 (blue) from cab power distribution block relay 10, terminal 1 to a known good ground.

If 22 to 28 VDC are not present, go to Step 12.

- Step 11. Turn battery disconnect switch to OFF position (WP 0007). Check for continuity across cab power distribution wire harness wire 1640 (black) from cab power distribution block relay 10, terminal 2 to a known good ground.
- a. If there is continuity, replace relay 10 (WP 0402).
  - b. If there is no continuity, replace cab power distribution wire harness and block (WP 0441).

**MALFUNCTION**  
**TEST OR INSPECTION**  
**CORRECTIVE ACTION**

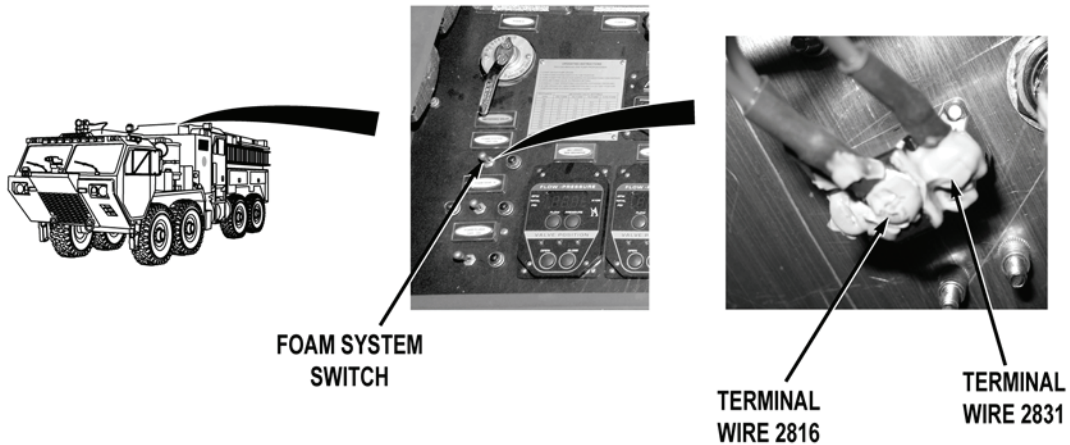

Step 12. Turn battery disconnect switch to OFF position (WP 0007). Open pump operator's panel housing (WP 0325). While an assistant holds pump operator's panel FOAM SYSTEM switch to OFF position (WP 0004), check for continuity across FOAM SYSTEM switch from, terminal wire 2816 (red) to terminal wire 2831 (blue).

If there is no continuity, replace pump operator's panel FOAM SYSTEM switch (WP 0330).

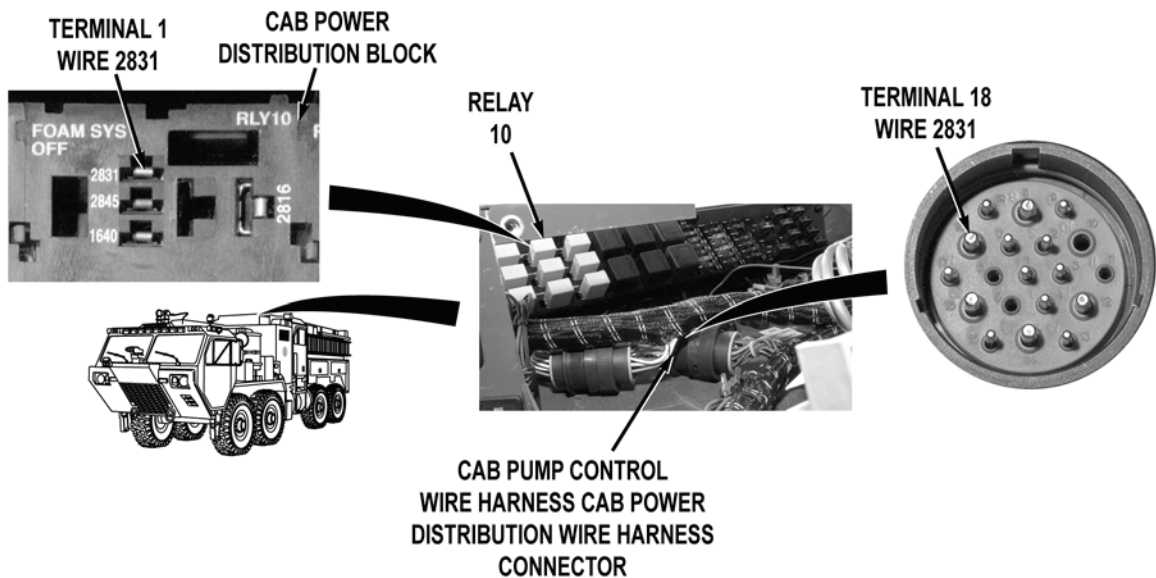

Step 13. Disconnect cab pump control wire harness cab power distribution wire harness connector. Check for continuity across cab power distribution wire harness wire 2831 (blue) from cab power distribution block relay 10, terminal 1 to cab pump control wire harness cab power distribution wire harness connector, terminal 18.

If there is no continuity, repair wire 2831 in cab power distribution wire harness if repairable (TM 9-2320-325-14&P), or replace cab power distribution wire harness and block (WP 0441).

**MALFUNCTION**

**TEST OR INSPECTION**

**CORRECTIVE ACTION**

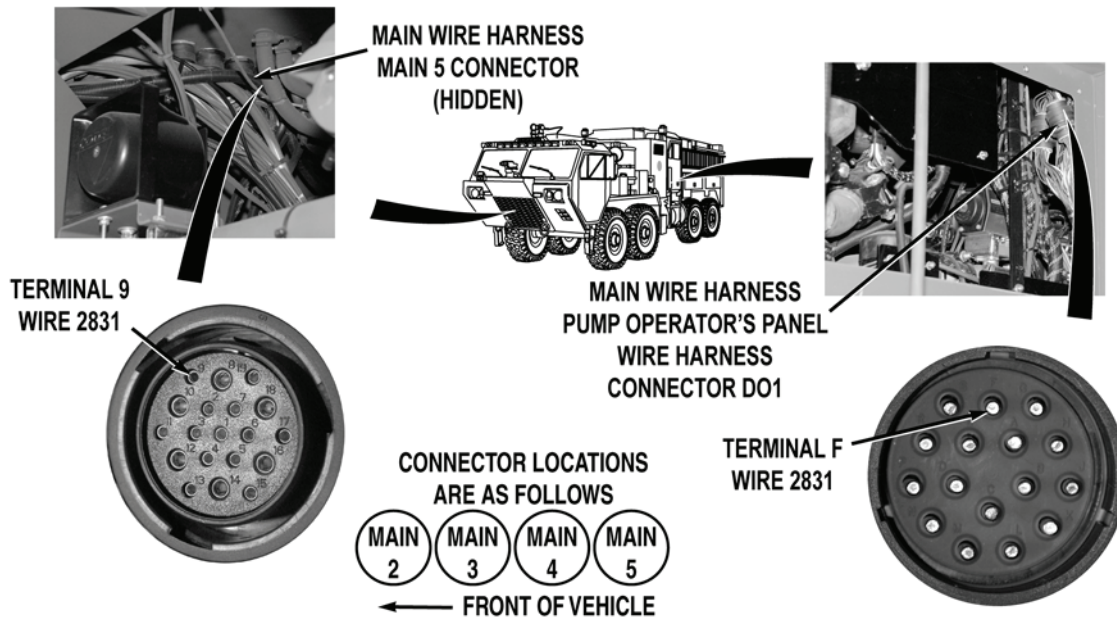

Step 14. Remove skid plate grille (WP 0550). Disconnect main wire harness main 5 connector. Remove driver side crew cab access panel (WP 0499). Remove pump house panel Q (WP 0540). Disconnect main wire harness pump operator's panel wire harness connector DO1. With a test lead set, check for continuity across wire 2831 (blue) from main wire harness main 5 connector, terminal 9 to main wire harness pump operator's panel wire harness connector DO1, terminal F.

If there is no continuity, repair wire 2831 in main wire harness if repairable (TM 9-2320-325-14&P), or replace main wire harness (WP 0455).

---

**MALFUNCTION**  
**TEST OR INSPECTION**  
**CORRECTIVE ACTION**

---

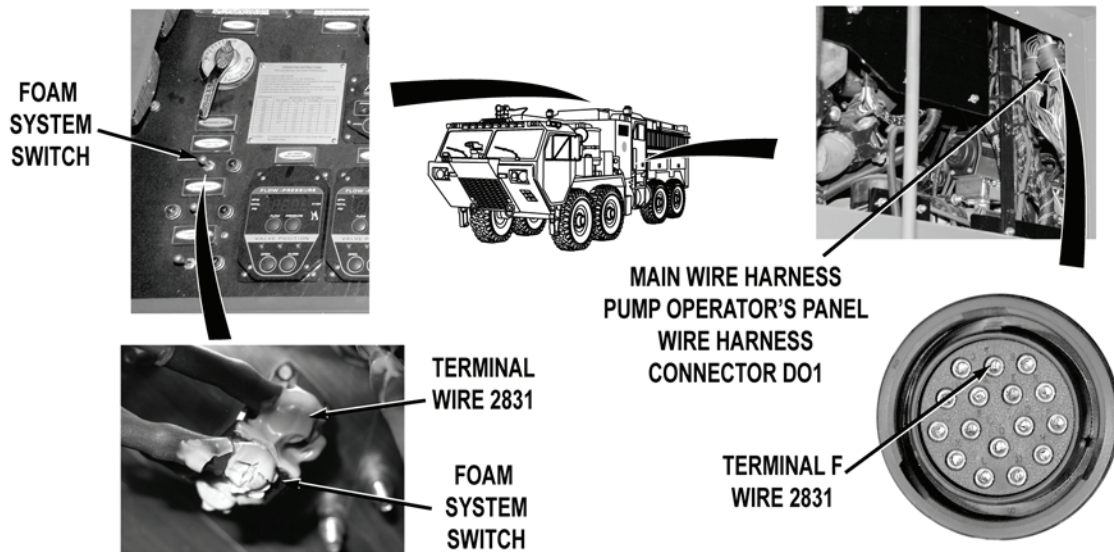

- Step 15. With a test lead set, check for continuity across pump operator's panel wire harness wire 2831 (blue) from main wire harness pump operator's panel wire harness connector DO1, terminal F to pump operator's panel FOAM SYSTEM switch, terminal.
- a. If there is continuity, repair wire 2831 in cab pump control wire harness if repairable (TM 9-2320-325-14&P), or replace cab pump control wire harness (WP 0443).
  - b. If there is no continuity, repair wire 2831 in pump operator's panel wire harness if repairable (TM 9-2320-325-14&P), or replace pump operator's panel wire harness (WP 0459).

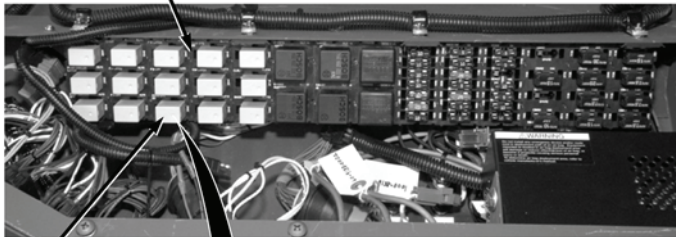
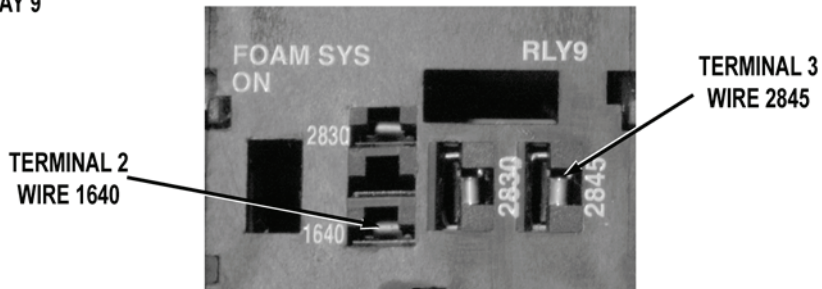
**MALFUNCTION****TEST OR INSPECTION****CORRECTIVE ACTION****CAB POWER DISTRIBUTION BLOCK****RELAY 9****WARNING**

**Remove rings, wristwatches, neck chains, and any other jewelry before working around vehicle. Jewelry can catch on equipment and cause serious injury. Jewelry and tools may short across electrical circuits and cause damage to equipment, or severe burns or electrical shock to personnel.**

- Step 16. Turn battery disconnect switch to OFF position (WP 0007). Remove personnel cab instrument panel A (WP 0311). Remove relay 9 from cab power distribution block (WP 0402). Turn battery disconnect switch to ON position (WP 0007). Check for 22 to 28 VDC between cab power distribution wire harness wire 2845 (white) from cab power distribution block relay 9, terminal 3 to a known good ground.

If 22 to 28 VDC are not present, go to Step 19.

- Step 17. Turn battery disconnect switch to OFF position (WP 0007). Check for continuity across cab power distribution wire harness wire 1640 (black) from cab power distribution block relay 9, terminal 2 to a known good ground.

If there is no continuity, replace cab power distribution wire harness and block (WP 0441).

---

<b>MALFUNCTION</b>	
<b>TEST OR INSPECTION</b>	
<b>CORRECTIVE ACTION</b>	

---

CAB POWER DISTRIBUTION BLOCK

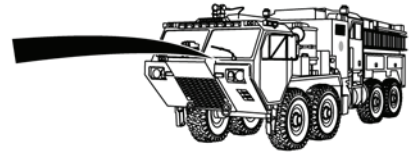
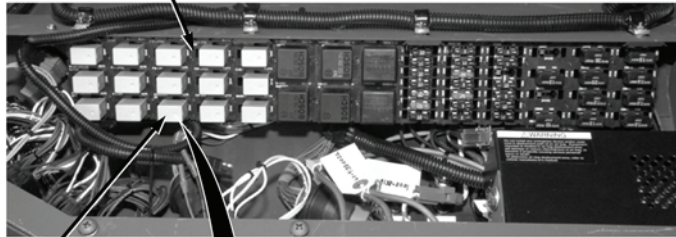

RELAY 9

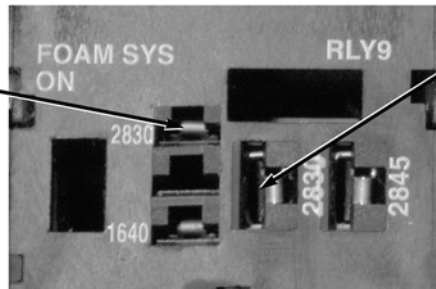
TERMINAL 1  
WIRE 2830TERMINAL 5  
WIRE 2830

- Step 18. Check for continuity across cab power distribution wire harness wire 2830 (red) from cab power distribution block relay 9, terminal 1 to terminal 5.
- a. If there is continuity, replace relay 9 (WP 0402).
  - b. If there is no continuity, replace cab power distribution wire harness and block (WP 0441).

## MALFUNCTION

## TEST OR INSPECTION

## CORRECTIVE ACTION

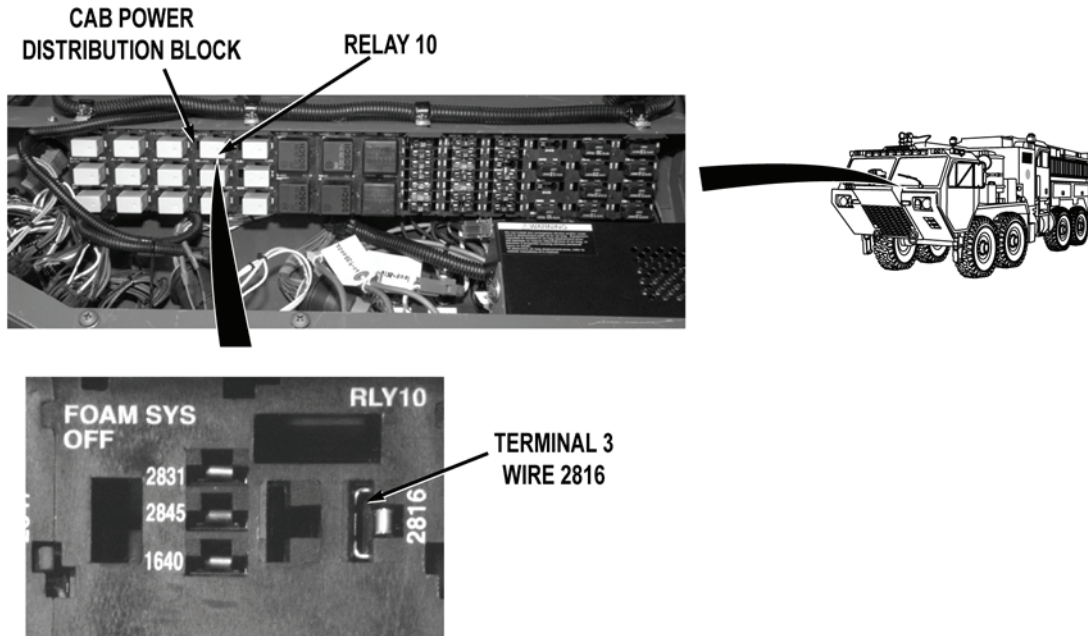
**WARNING**

Remove rings, wristwatches, neck chains, and any other jewelry before working around vehicle. Jewelry can catch on equipment and cause serious injury. Jewelry and tools may short across electrical circuits and cause damage to equipment, or severe burns or electrical shock to personnel.

- Step 19. Remove relay 10 from cab power distribution block (WP 0402). Check for 22 to 28 VDC between cab power distribution wire harness wire 2816 (red) from cab power distribution block relay 10, terminal 3 to a known good ground.

If 22 to 28 VDC are not present, replace cab power distribution wire harness and block (WP 0441).



## MALFUNCTION

## TEST OR INSPECTION

## CORRECTIVE ACTION

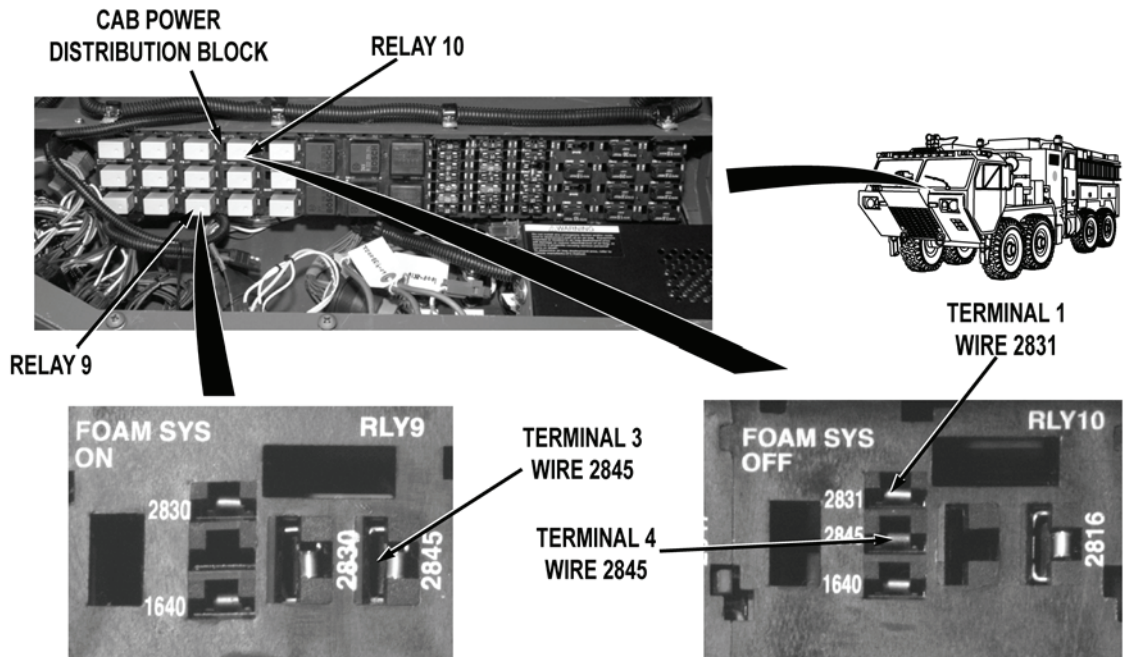

- Step 20. Turn battery disconnect switch to OFF position (WP 0007). Check for continuity across cab power distribution wire harness wire 2845 (white) from cab power distribution block relay 9, terminal 3 to cab power distribution block relay 10, terminal 4.

If there is no continuity, replace cab power distribution wire harness and block (WP 0441).

- Step 21. Turn battery disconnect switch to ON position (WP 0007). While an assistant holds cab FOAM SYSTEM switch to off position (WP 0004), check for 22 to 28 VDC between cab power distribution wire harness wire 2831 (blue) from cab power distribution block relay 10, terminal 1 to a known good ground.
- a. If 22 to 28 VDC are present, replace relay 10 (WP 0402).
  - b. If 22 to 28 VDC are not present, repair wire 2831 in cab pump control wire harness if repairable (TM 9-2320-325-14&P), or replace cab pump control wire harness (WP 0443).

**MALFUNCTION**

**TEST OR INSPECTION**

**CORRECTIVE ACTION**



Step 22. While an assistant puts personnel cab FOAM SYSTEM switch to on position (WP 0004), check if eductor valve operates to open position.

If eductor valve does not operate to open position, go to Step 29.

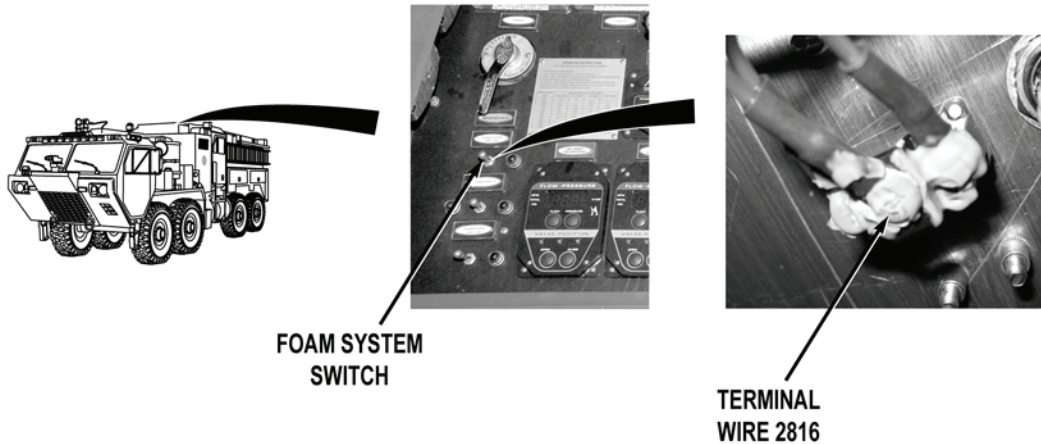
**MALFUNCTION****TEST OR INSPECTION****CORRECTIVE ACTION****WARNING**

**Remove rings, wristwatches, neck chains, and any other jewelry before working around vehicle. Jewelry can catch on equipment and cause serious injury. Jewelry and tools may short across electrical circuits and cause damage to equipment, or severe burns or electrical shock to personnel.**

- Step 23. Open pump operator's panel housing (WP 0325). Check for 22 to 28 VDC between wire 2816 (red) from pump operator's panel FOAM SYSTEM switch, terminal to a known good ground.

If 22 to 28 VDC are present, go to Step 26.

**MALFUNCTION**

**TEST OR INSPECTION**

**CORRECTIVE ACTION**

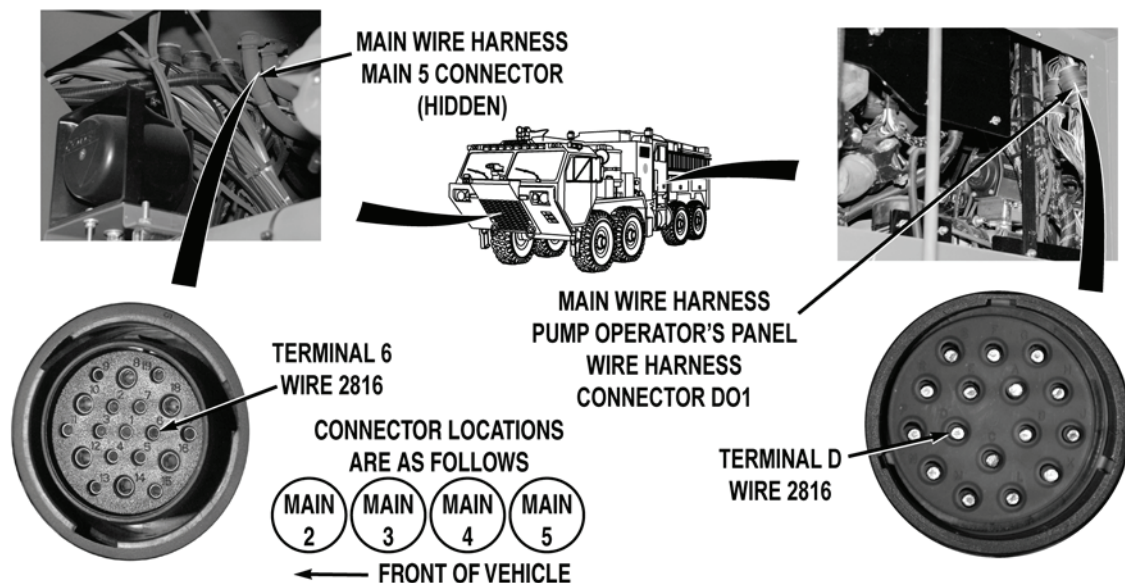

Step 24. Close pump operator's panel housing (WP 0325). Remove skid plate grille (WP 0550). Disconnect main wire harness main 5 connector. Remove driver side crew cab access panel (WP 0499). Remove pump house panel Q (WP 0540). Disconnect main wire harness pump operator's panel wire harness connector DO1. With a test lead set, check for continuity across wire 2816 (red) from main wire harness main 5 connector, terminal 6 to main wire harness pump operator's panel wire harness connector DO1, terminal D.

If there is no continuity, repair wire 2816 in main wire harness if repairable (TM 9-2320-325-14&P), or replace main wire harness (WP 0455).

---

<b>MALFUNCTION</b>		
	<b>TEST OR INSPECTION</b>	
		<b>CORRECTIVE ACTION</b>

---

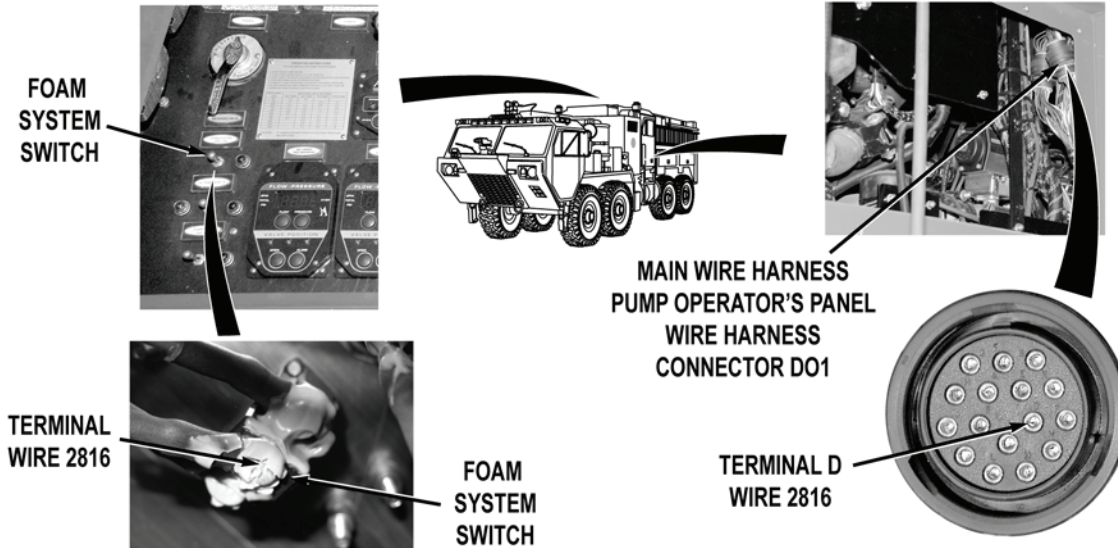

- Step 25. Open pump operator's panel housing (WP 0325). With a test lead set, check for continuity across pump operator's panel wire harness wire 2816 (red) from main wire harness pump operator's panel wire harness connector DO1, terminal D to pump operator's panel FOAM SYSTEM switch, terminal.
- a. If there is continuity, repair wire 2816 in cab pump control wire harness if repairable (TM 9-2320-325-14&P), or replace cab pump control wire harness (WP 0443).
  - b. If there is no continuity, repair wire 2816 in pump operator's panel wire harness if repairable (TM 9-2320-325-14&P), or replace pump operator's panel wire harness (WP 0459).

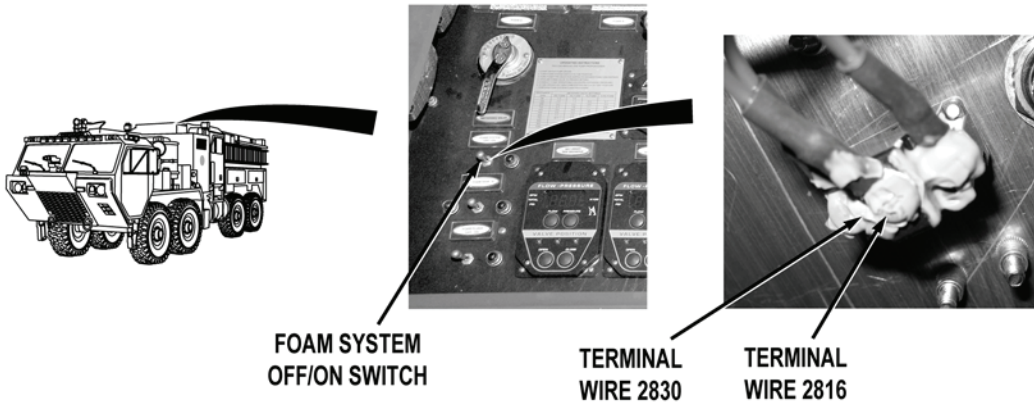
**MALFUNCTION****TEST OR INSPECTION****CORRECTIVE ACTION****WARNING**

**Remove rings, wristwatches, neck chains, and any other jewelry before working around vehicle. Jewelry can catch on equipment and cause serious injury. Jewelry and tools may short across electrical circuits and cause damage to equipment, or severe burns or electrical shock to personnel.**

- Step 26. Turn battery disconnect switch to OFF position (WP 0007). While an assistant holds pump operator's panel FOAM SYSTEM switch to ON position (WP 0004), check for continuity across FOAM SYSTEM switch from terminal wire 2816 (red) to terminal wire 2830 (red).

If there is no continuity, replace pump operator's panel FOAM SYSTEM switch (WP 0330).

---

**MALFUNCTION**  
**TEST OR INSPECTION**  
**CORRECTIVE ACTION**

---

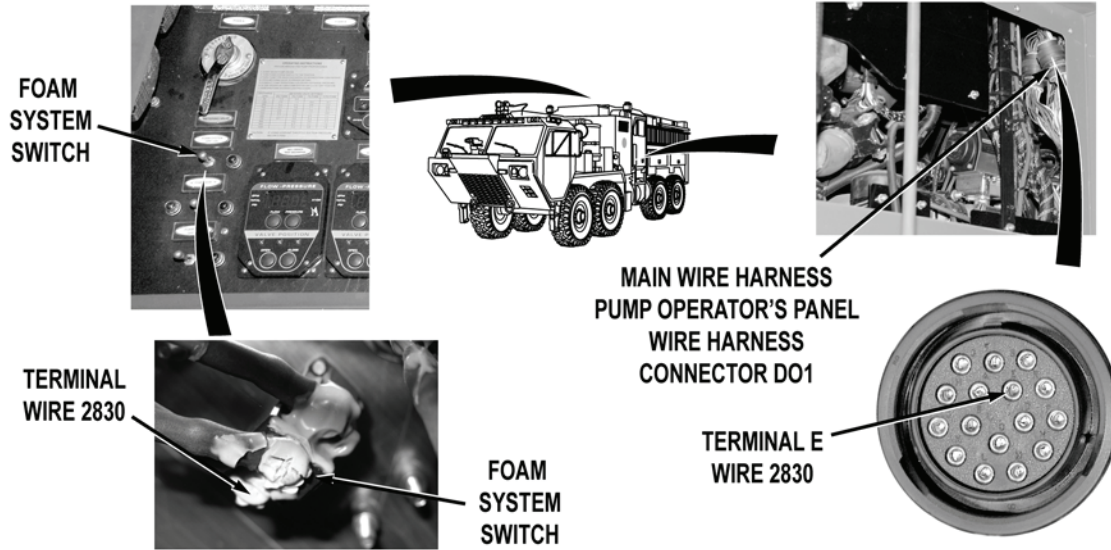

Step 27. Remove driver side crew cab access panel (WP 0499). Remove pump house panel Q (WP 0540). Disconnect main wire harness pump operator's panel wire harness connector DO1. With a test lead set, check for continuity across pump operator's panel wire harness wire 2830 (red) from main wire harness pump operator's panel wire harness connector DO1, terminal E to pump operator's panel FOAM SYSTEM switch, terminal.

If there is no continuity, repair wire 2830 in pump operator's panel wire harness if repairable (TM 9-2320-325-14&P), or replace pump operator's panel wire harness (WP 0459).

**MALFUNCTION**

**TEST OR INSPECTION**

**CORRECTIVE ACTION**

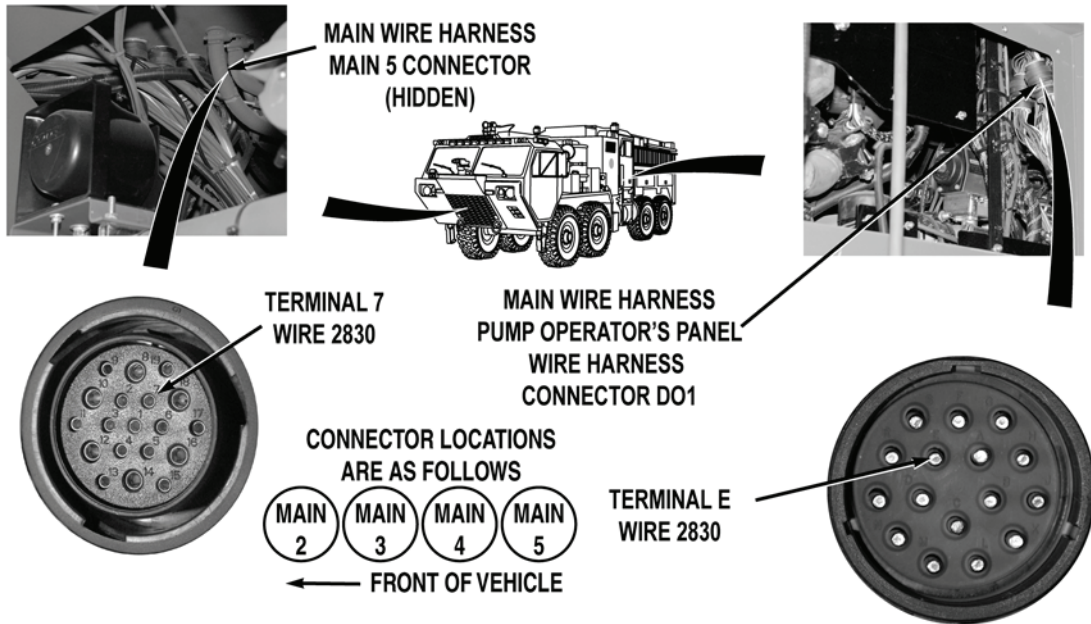

- Step 28. Remove skid plate grille (WP 0550). Disconnect main wire harness main 5 connector. With a test lead set, check for continuity across wire 2830 (red) from main wire harness main 5 connector, terminal 7 to main wire harness pump operator's panel wire harness connector DO1, terminal E.
- a. If there is continuity, repair wire 2830 in cab pump control wire harness if repairable (TM 9-2320-325-14&P), or replace cab pump control wire harness (WP 0443).
  - b. If there is no continuity, repair wire 2830 in main wire harness if repairable (TM 9-2320-325-14&P), or replace main wire harness (WP 0455).



---

**MALFUNCTION**  
**TEST OR INSPECTION**  
**CORRECTIVE ACTION**

---

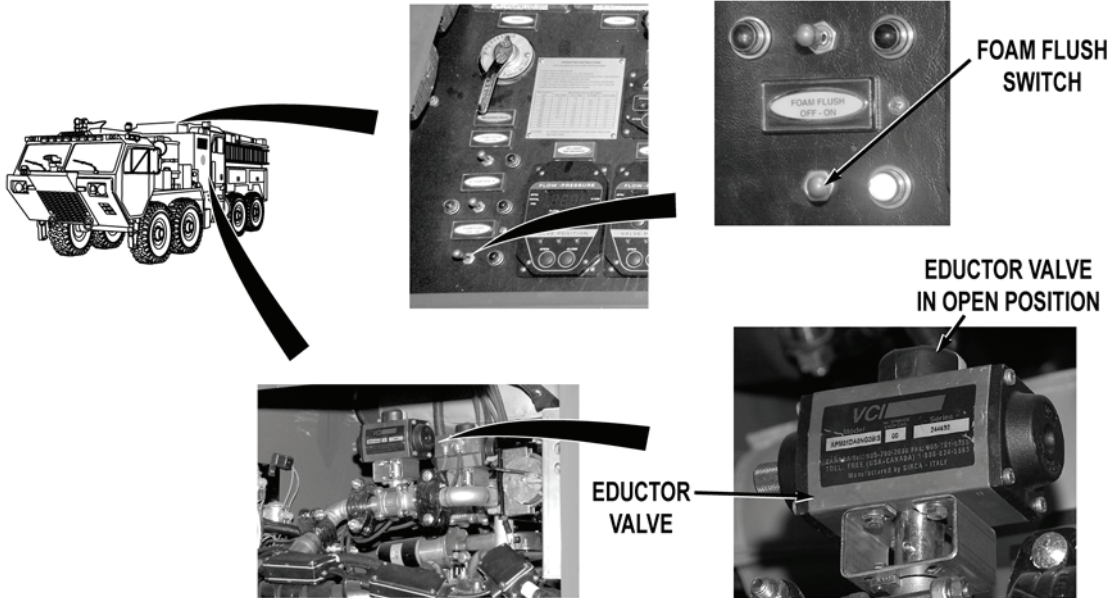

Step 29. While an assistant puts pump operator's panel FOAM FLUSH switch to ON position (WP 0004), check if eductor valve operates to open position.

If eductor valve does not operate to open position, go to Step 34.

**MALFUNCTION**

**TEST OR INSPECTION**

**CORRECTIVE ACTION**

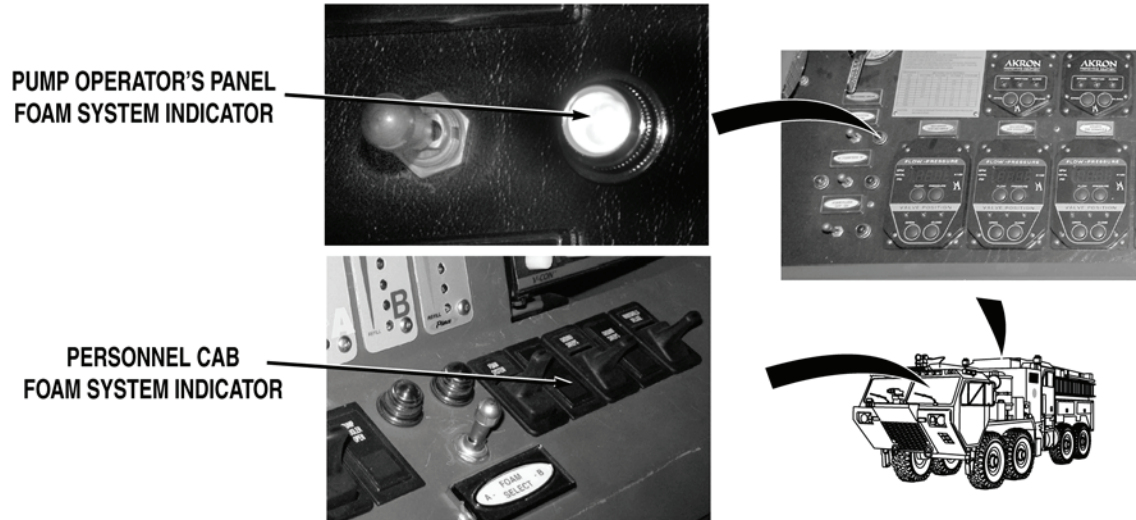

Step 30. Put pump operator's panel FOAM FLUSH switch to OFF position (WP 0004). Put personnel cab or pump operator's panel FOAM SYSTEM switch to ON position (WP 0004). Check if foam system indicator illuminates at pump operator's panel or personnel cab.

If foam system indicator does not illuminate, go to Step 32.

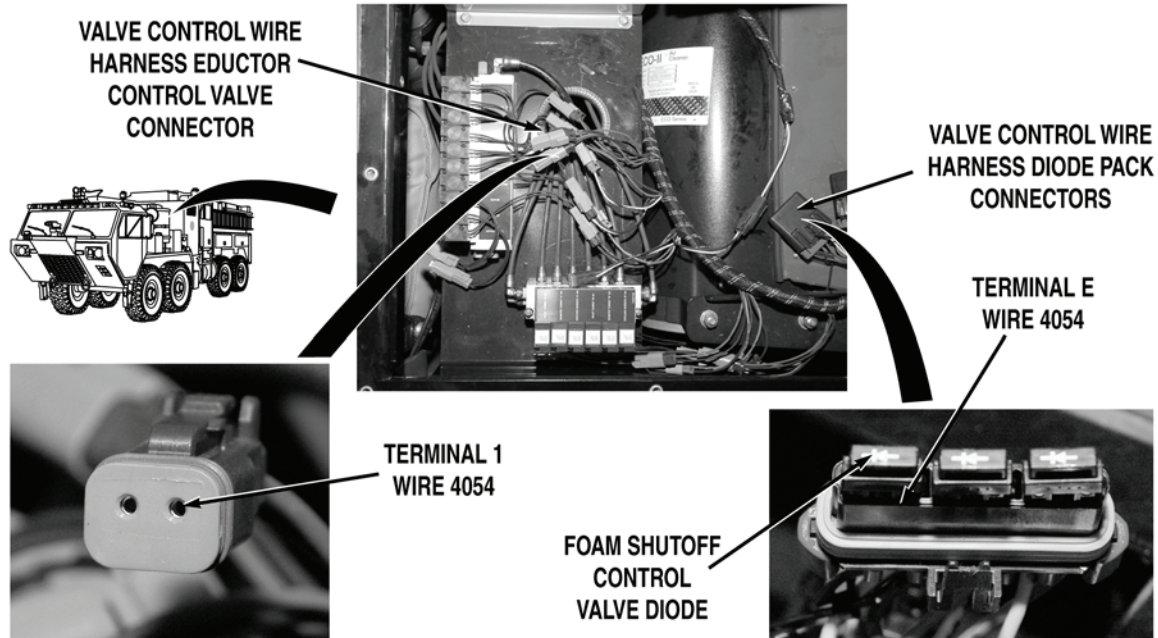
**MALFUNCTION****TEST OR INSPECTION****CORRECTIVE ACTION**

- Step 31. Remove pump house panel S (WP 0540). Remove foam shutoff control valve diode pack from valve control wire harness connector. Disconnect valve control wire harness eductor control valve connector. With a test lead set, check for continuity across valve control wire harness wire 4054 (yellow) from valve control wire harness eductor shutoff control valve connector, terminal E to valve control wire harness eductor control valve connector, terminal 1.
- a. If there is continuity, replace shutoff control valve diode pack (WP 0426).
  - b. If there is no continuity, repair wire 4054 in valve control wire harness if repairable (TM 9-2320-325-14&P), or replace valve control wire harness (WP 0463).

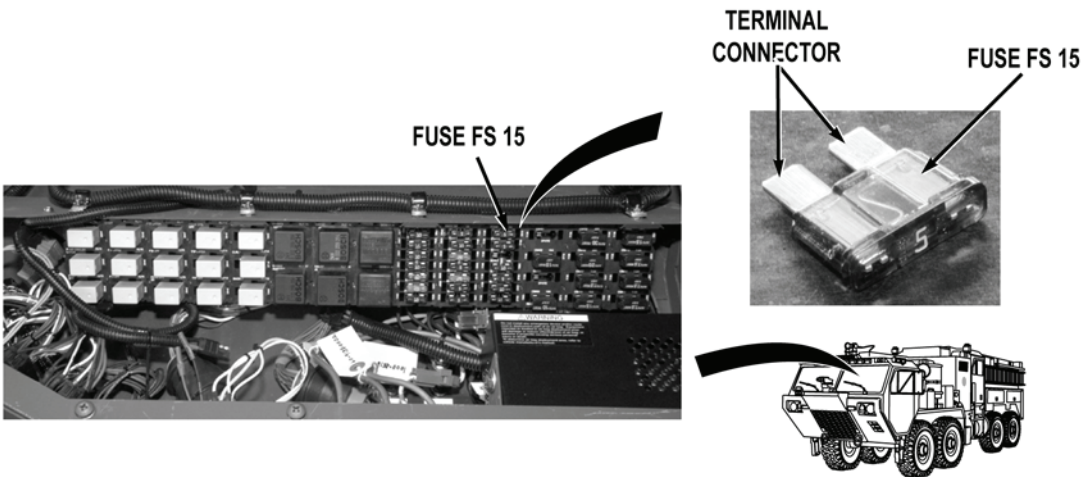
**MALFUNCTION****TEST OR INSPECTION****CORRECTIVE ACTION****WARNING**

**Remove rings, wristwatches, neck chains, and any other jewelry before working around vehicle. Jewelry can catch on equipment and cause serious injury. Jewelry and tools may short across electrical circuits and cause damage to equipment, or severe burns or electrical shock to personnel.**

- Step 32. Turn battery disconnect switch to OFF position (WP 0007). Remove personnel cab instrument panel A (WP 0311). Remove fuse FS 15 from cab power distribution block (WP 0401). Check for continuity across fuse.

If there is no continuity, replace fuse FS 15 (WP 0401).

---

**MALFUNCTION**  
**TEST OR INSPECTION**  
**CORRECTIVE ACTION**

---

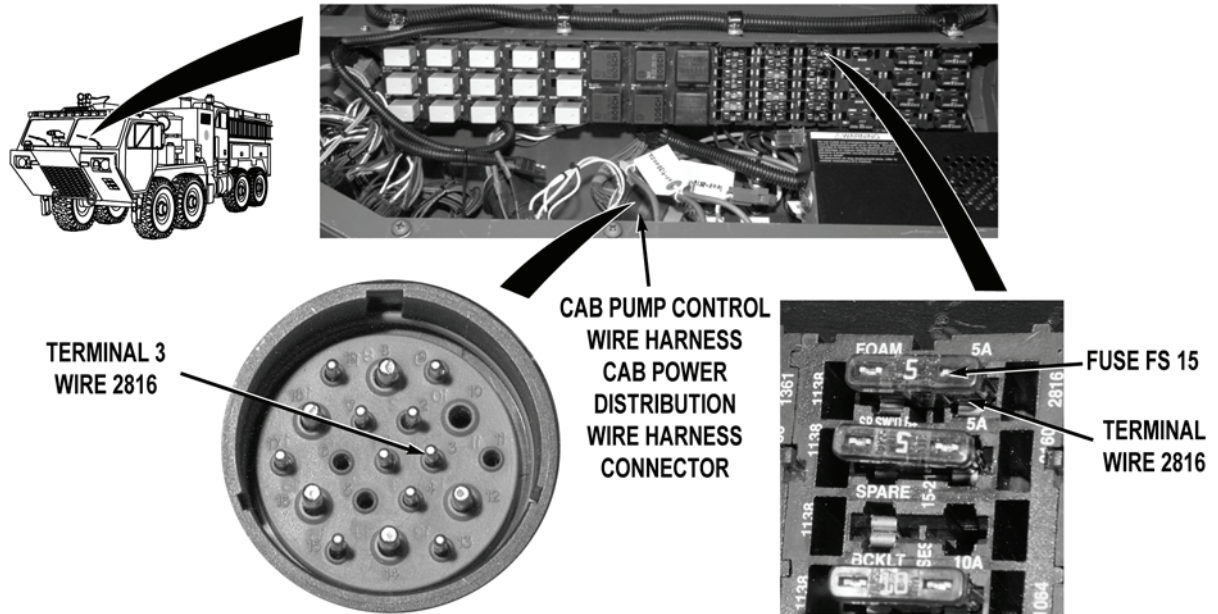

- Step 33. Disconnect cab pump control wire harness cab power distribution wire harness connector. Check for continuity across cab power distribution wire harness wire 2816 (red) from cab power distribution block fuse FS 15, terminal to cab pump control wire harness cab power distribution wire harness connector, terminal 3.
- a. If there is continuity, repair wire 2816 in cab pump control wire harness if repairable (TM 9-2320-325-14&P), or replace cab pump control wire harness (WP 0443).
  - b. If there is no continuity, repair wire 2816 in cab power distribution wire harness if repairable (TM 9-2320-325-14&P), or replace cab power distribution wire harness and block (WP 0441).

**MALFUNCTION**

**TEST OR INSPECTION**

**CORRECTIVE ACTION**

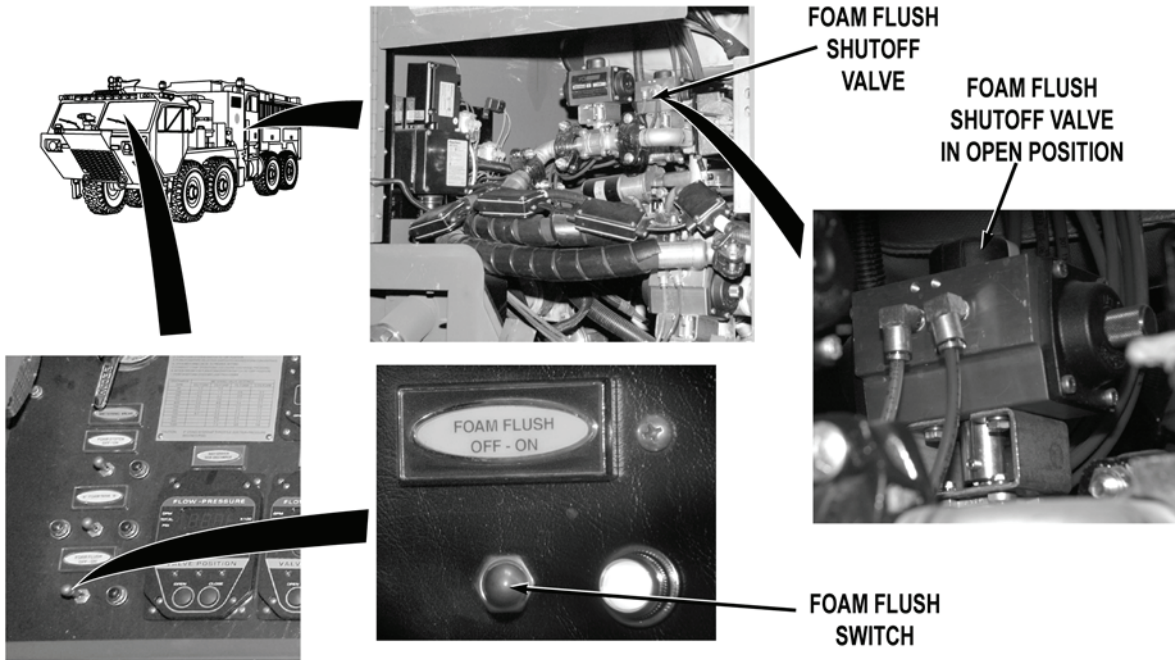

Step 34. While an assistant puts pump operator's panel FOAM FLUSH switch to ON and OFF positions (WP 0004), check if foam flush shutoff valve operates to open and closed position.

If foam flush shutoff valve does not operate to open and closed positions, replace air line from vehicle air reservoir to shutoff control valve manifold (WP 0567).

---

**MALFUNCTION**  
**TEST OR INSPECTION**  
**CORRECTIVE ACTION**

---

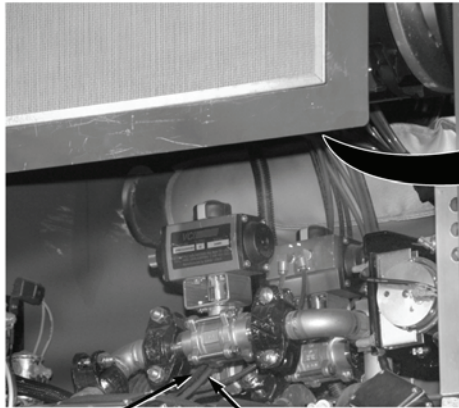

**BLUE AIR LINE**  
**RED AIR LINE**

**RED AIR LINE TO EDUCTOR CONTROL VALVE**  
**BLUE AIR LINE TO EDUCTOR CONTROL VALVE**  
**SHUTOFF CONTROL VALVE MANIFOLD**

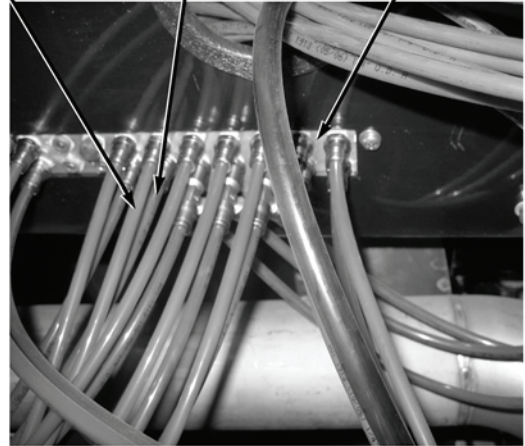

Step 35. Inspect air lines from shutoff control valve manifold to eductor valve for leaks, kinks, and/or damage.

If air lines leak, are kinked, or damaged, replace air lines (WP 0567).

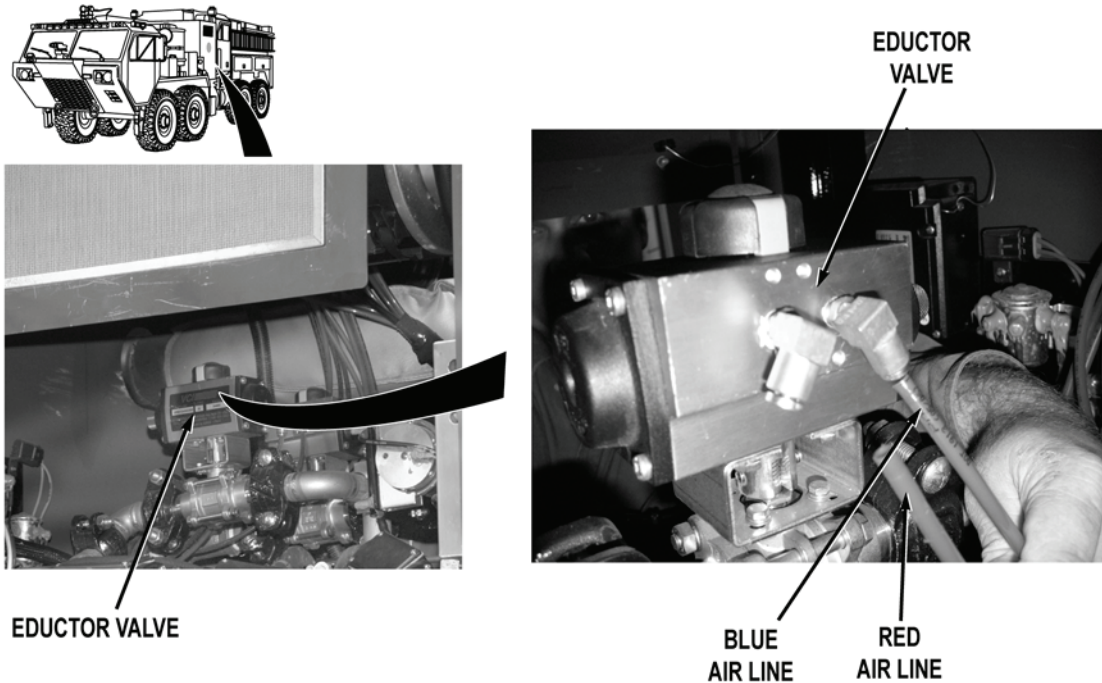
**MALFUNCTION****TEST OR INSPECTION****CORRECTIVE ACTION****NOTE**

Air pressure is checked by disconnecting air lines at eductor valve and observing air pressure escaping from air line, when eductor control valve is activated. Air will escape from the blue air line when FOAM SYSTEM switch is positioned to ON position and escape from red air line when FOAM SYSTEM switch is positioned to OFF position. System air pressure may drop below 85 psi (586 kPa) during this procedure.

- Step 36. Disconnect red and blue air lines from eductor valve. While an assistant puts cab or pump operator's panel FOAM SYSTEM switch to ON and OFF position (WP 0004), check if air pressure is present at eductor valve.

If there is air pressure, replace eductor valve (WP 0287).

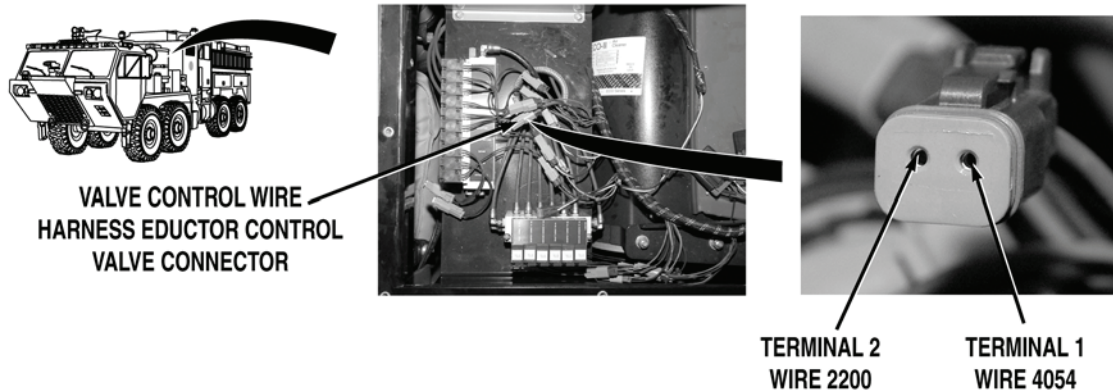

**MALFUNCTION****TEST OR INSPECTION****CORRECTIVE ACTION**

- Step 37. Connect air lines at eductor valve. Disconnect valve control wire harness eductor control valve connector. Put cab or pump operator's panel FOAM SYSTEM switch to on position (WP 0004) and release. With a test lead set, check for 22 to 28 VDC between valve control wire harness wire 4054 (yellow) at valve control wire harness eductor control valve connector, terminal 1 and a known good ground.

If 22 to 28 VDC are not present, repair wire 4054 in valve control wire harness if repairable (TM 9-2320-325-14&P), or replace valve control wire harness (WP 0463).

- Step 38. Turn battery disconnect switch to ON position (WP 0007). Check for continuity across valve control wire harness wire 2200 (black) from valve control wire harness eductor control valve connector, terminal 2 to a known good ground.

If there is continuity, replace shutoff control valve manifold (WP 0427).

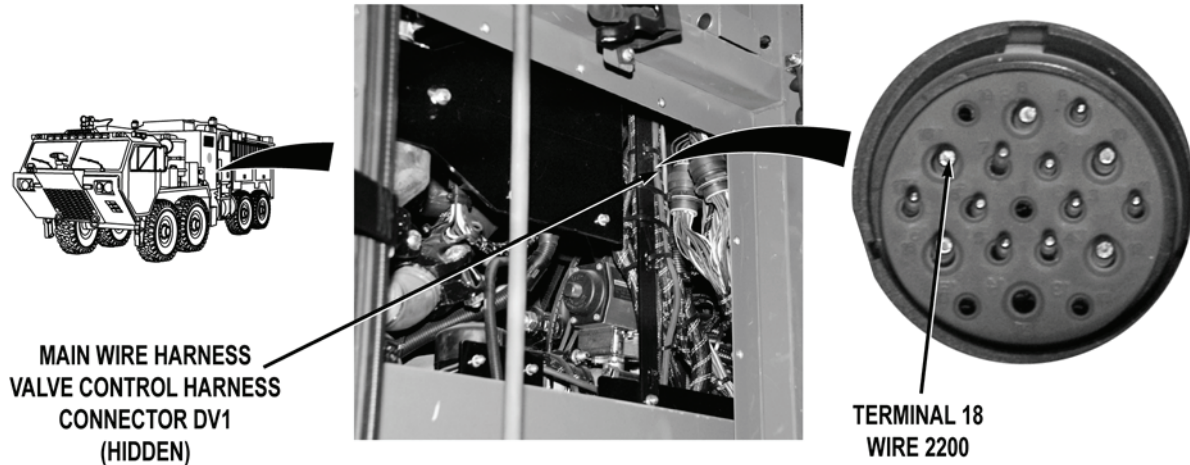
**MALFUNCTION****TEST OR INSPECTION****CORRECTIVE ACTION**

- Step 39. Remove driver side crew cab access panel (WP 0499). Remove pump house panel Q (WP 0540). Disconnect main wire harness valve control wire harness connector DV1. Check for continuity across wire 2200 (black) from main wire harness valve control wire harness connector DV1, terminal 18 to a known good ground.
- a. If there is continuity, repair wire 2200 in valve control wire harness if repairable (TM 9-2320-325-14&P), or replace valve control wire harness (WP 0463).
  - b. If there is no continuity, repair wire 2200 in main wire harness if repairable (TM 9-2320-325-14&P), or replace main wire harness (WP 0455).

**END OF TASK****FOLLOW-ON MAINTENANCE**

1. Install driver side crew cab access panel (WP 0499)
2. Install pump house panel Q (WP 0540)
3. Install skid plate grille (WP 0550)
4. Remove wheel chocks (TM 9-2320-347-10)

**END OF TASK****END OF WORK PACKAGE**

**FIELD LEVEL MAINTENANCE**

**FOAM NOT DELIVERED WHEN TANK A IS SELECTED (BUMPER TURRET, GROUND SWEEPS, AND MANUAL METERING CONTROLS)**

**INITIAL SETUP:**

**Tools and Special Tools**

- Lead Set, Test (WP 0622, Item 21)
- Tool Kit, General Mechanic's: Automotive (WP 0622, Item 27)

**Personnel Required**

- MOS 63B Wheeled vehicle mechanic (2)

**References**

- TM 9-2320-325-14&P
- WP 0004
- WP 0007
- WP 0019
- WP 0031
- WP 0094
- WP 0282
- WP 0284
- WP 0308
- WP 0311
- WP 0315

**References (continued)**

- WP 0325
- WP 0337
- WP 0402
- WP 0427
- WP 0441
- WP 0443
- WP 0455
- WP 0459
- WP 0463
- WP 0499
- WP 0539
- WP 0540
- WP 0550
- WP 0567

**Equipment Conditions**

- Water pump engine OFF (WP 0022)
- Engine OFF (TM 9-2320-347-10)
- Wheels chocked (TM 9-2320-347-10)

**MALFUNCTION**

**TEST OR INSPECTION**

**CORRECTIVE ACTION**

**FOAM NOT DELIVERED WHEN TANK A IS SELECTED (BUMPER TURRET, GROUND SWEEPS, AND MANUAL METERING CONTROLS)**

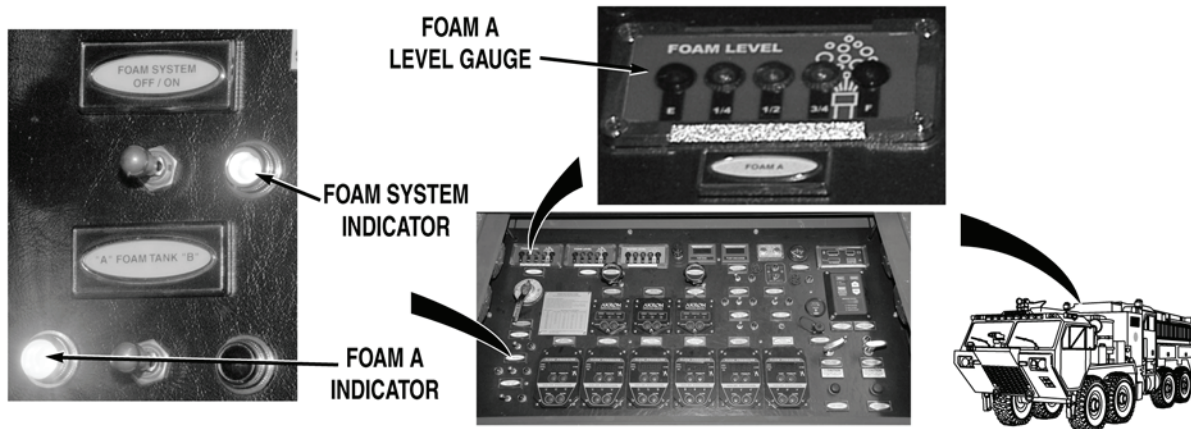
**MALFUNCTION****TEST OR INSPECTION****CORRECTIVE ACTION**

**⚠ CAUTION**

**Do not mix different types or brands of foam agent in foam tanks or piping. Mixing of different foam agents (either type or manufacturer) may cause deterioration of foam agent, improper proportioning and poor performance in a fire situation. Mixing of Class A and Class B foam agents may result in a chemical reaction which can create globules, which can clog orifices and cause system failure.**

- Step 1. Turn battery disconnect switch to ON position (WP 0007). Open pump operator's panel (WP 0019). Check level indicated at pump operator's panel FOAM A LEVEL gauge (WP 0004).
- If FOAM A LEVEL gauge indicated E (empty), fill foam A tank (WP 0031).
- Step 2. Put pump operator's panel FOAM SYSTEM switch to ON position (WP 0004). Check if FOAM SYSTEM indicator illuminates (WP 0004).
- If FOAM SYSTEM indicator does not illuminate, troubleshoot Foam Not Delivered From All Systems (Bumper Turret, Ground Sweeps, and Manual Metering Controls) or System Does Not Shut Off (WP 0094).
- Step 3. Put and hold pump operator's panel FOAM TANK switch to "A" position (WP 0004). Check if foam A indicator illuminates (WP 0004).
- If foam A indicator does not illuminate, go to Step 24.
- Step 4. Release pump operator's panel FOAM TANK switch (WP 0004). Check if foam A indicator remains illuminated.
- If foam A indicator remains illuminated, go to Step 13.

---

<b>MALFUNCTION</b>	<b>TEST OR INSPECTION</b>	<b>CORRECTIVE ACTION</b>
--------------------	---------------------------	--------------------------

---

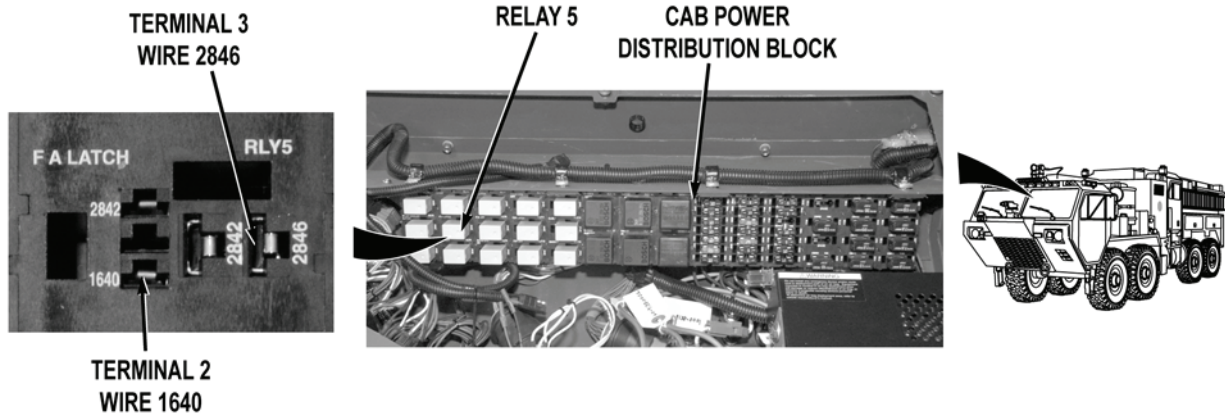
**WARNING**

**Remove rings, wristwatches, neck chains, and any other jewelry before working around vehicle. Jewelry can catch on equipment and cause serious injury. Jewelry and tools may short across electrical circuits and cause damage to equipment, or severe burns or electrical shock to personnel.**

- Step 5. Turn battery disconnect switch to OFF position (WP 0007). Remove personnel cab instrument panel A (WP 0311). Remove relay 5 from cab power distribution block (WP 0402). Turn battery disconnect switch to ON position (WP 0007). Put personnel cab FOAM SYSTEM switch to on position (WP 0004). Check for 22 to 28 VDC between wire 2846 (white) from cab power distribution block relay 5, terminal 3 to a known good ground.

If 22 to 28 VDC are not present, go to Step 12.

- Step 6. Turn battery disconnect switch to OFF position (WP 0007). Check for continuity across wire 1640 (black) from cab power distribution block relay 5, terminal 2 to a known good ground.

If there is no continuity, replace cab power distribution wire harness and block (WP 0441).

## MALFUNCTION

## TEST OR INSPECTION

## CORRECTIVE ACTION

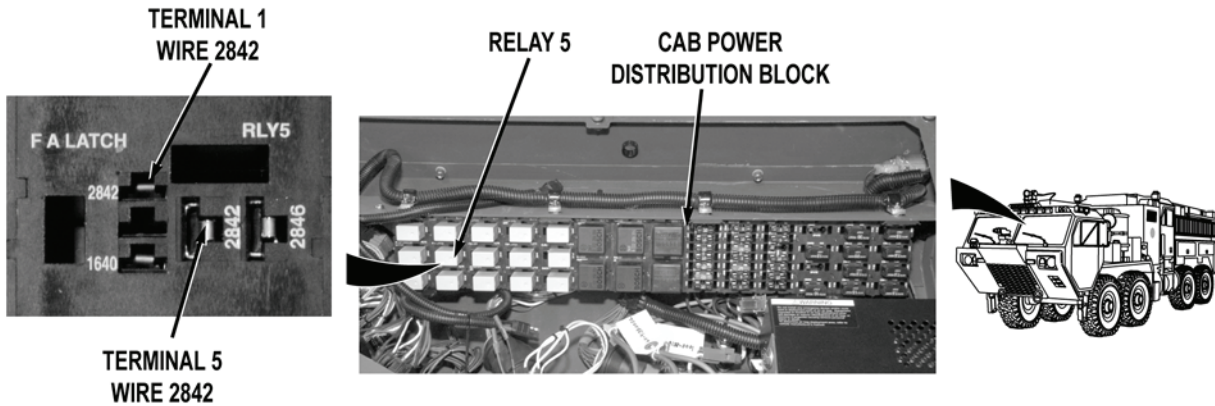

Step 7. Turn battery disconnect switch to ON position (WP 0007). Put pump operator's panel FOAM SYSTEM switch to ON position (WP 0004). While an assistant holds pump operator's panel FOAM TANK switch to "A" position (WP 0004), check for 22 to 28 VDC across wire 2842 (red) from cab power distribution block relay 5, terminals 1 and 5 to a known good ground.

- a. If 22 to 28 VDC are present at both terminals, replace relay 5 (WP 0402).
- b. If 22 to 28 VDC are present at one but not both terminals, replace cab power distribution wire harness and block (WP 0441).
- c. If 22 to 28 VDC are not present, go to Step 8.

**WARNING**

**Remove rings, wristwatches, neck chains, and any other jewelry before working around vehicle. Jewelry can catch on equipment and cause serious injury. Jewelry and tools may short across electrical circuits and cause damage to equipment, or severe burns or electrical shock to personnel.**

Step 8. While an assistant puts and holds personnel cab FOAM SELECT switch to "A" position (WP 0004), check for 22 to 28 VDC across wire 2842 (red) from cab power distribution block relay 5, terminals 1 or 5 to a known good ground.

If 22 to 28 VDC are present, go to Step 10.

---

**MALFUNCTION**  
**TEST OR INSPECTION**  
**CORRECTIVE ACTION**

---

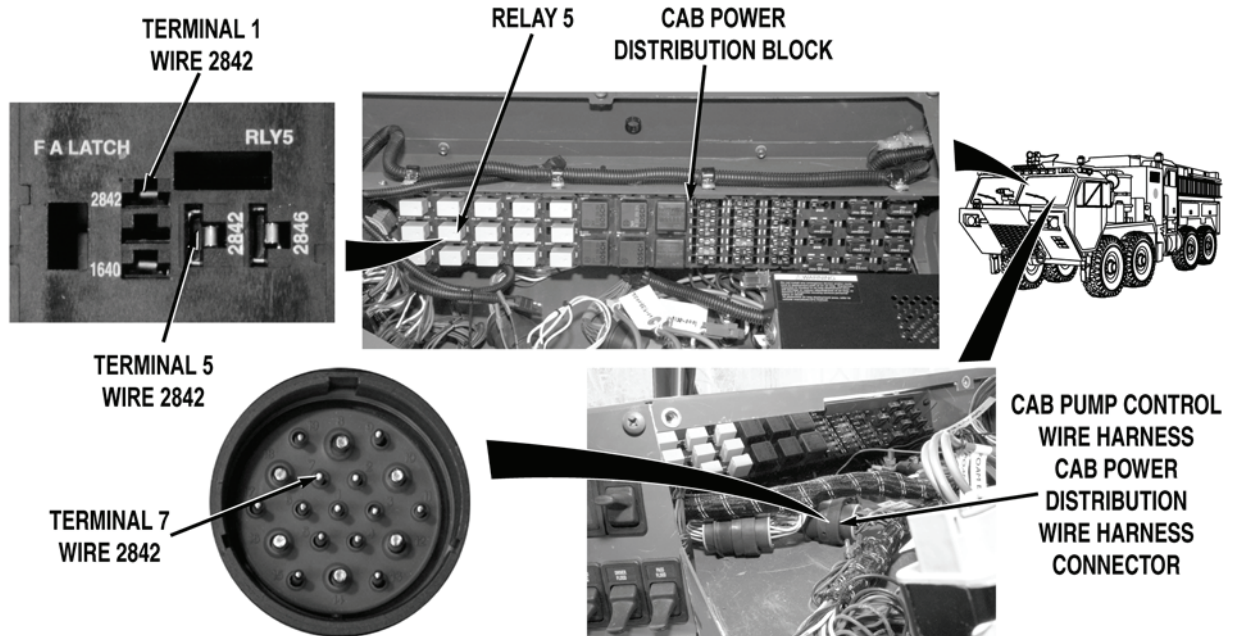

- Step 9. Turn battery disconnect switch to OFF position (WP 0007). Disconnect cab pump control wire harness cab power distribution wire harness connector. With a test lead set, check for continuity across cab power distribution wire harness wire 2842 (red) from cab pump control wire harness cab power distribution wire harness connector, terminal 7 to cab power distribution block relay 5, terminals 1 or 5.
- a. If there is continuity, repair wire 2842 in cab pump control wire harness if repairable (TM 9-2320-325-14&P), or replace cab pump control wire harness (WP 0443).
  - b. If there is no continuity, repair wire 2842 in cab power distribution wire harness if repairable (TM 9-2320-325-14&P), or replace cab power distribution wire harness and block (WP 0441).

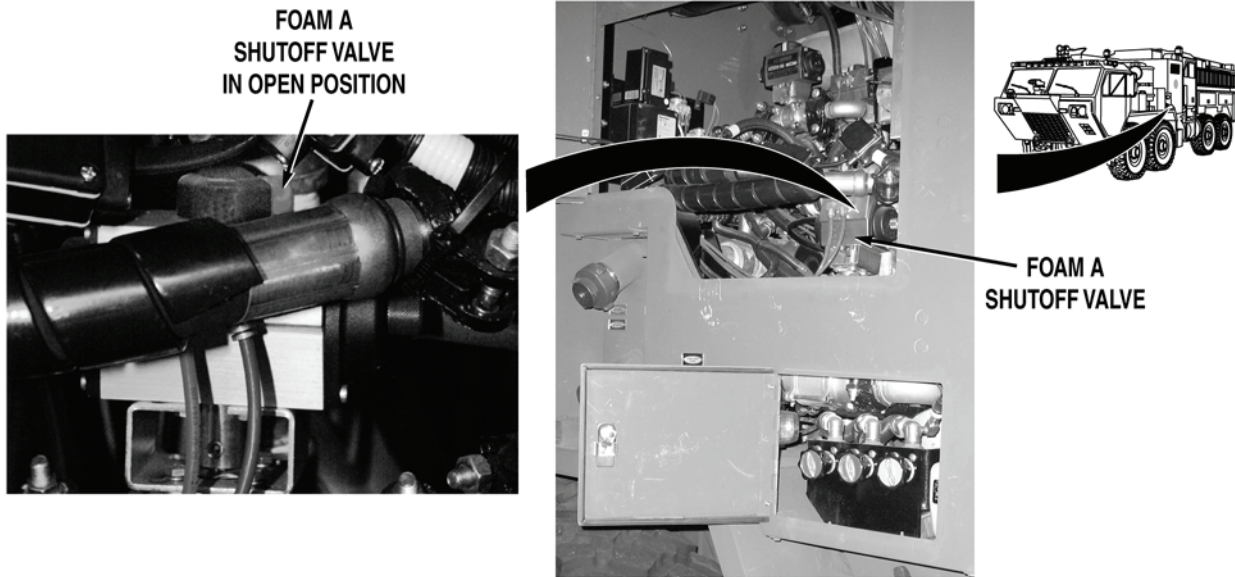
**MALFUNCTION****TEST OR INSPECTION****CORRECTIVE ACTION****NOTE**

- Ensure system air pressure is at least 85 psi (586 kPa) during this procedure. System air pressure is required to activate valves.
- Do not engage water pump engine during this procedure, except when performing complete system checks. Valve operations can be checked without water pump operation.
- Valve operations can be checked by observing valve shaft rotation. Valves are open when tabs or yellow paint tabs are aligned with direction of fluid flow.

Step 10. Open pump house panel A (WP 0539). While an assistant puts and holds pump operator's panel FOAM TANK switch to "A" position (WP 0004), check if foam A shutoff valve operates to open position.

If foam A shutoff valve operates to open position, repair wire 2842 (red) in main wire harness if repairable (TM 9-2320-325-14&P), or replace main wire harness (WP 0455).



## MALFUNCTION

## TEST OR INSPECTION

## CORRECTIVE ACTION

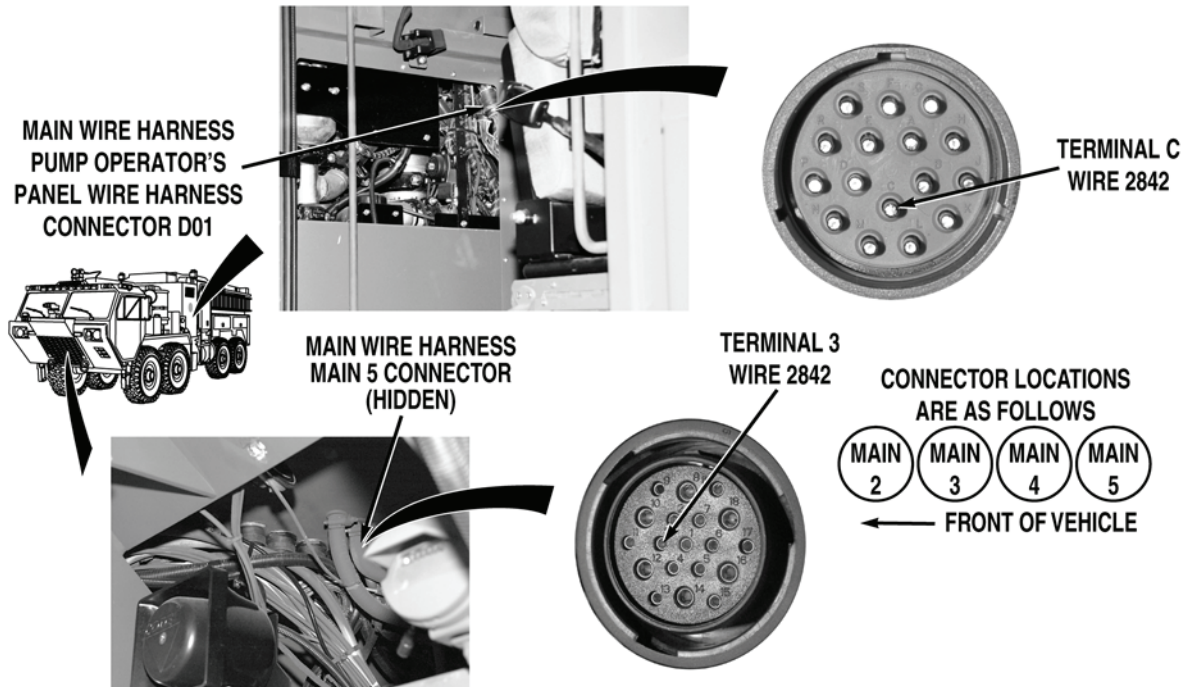

- Step 11. Remove skid plate grille (WP 0550). Disconnect main wire harness main 5 connector. Remove driver side crew cab access panel (WP 0499). Remove pump house panel Q (WP 0540). Disconnect main wire harness pump operator's panel wire harness connector DO1. With a test lead set, check for continuity across main wire harness wire 2842 (red) from main wire harness main 5 connector, terminal 3 to main wire harness pump operator's panel wire harness connector DO1, terminal C.
- If there is continuity, repair wire 2842 in pump operator's panel wire harness if repairable (TM 9-2320-325-14&P), or replace pump operator's panel wire harness (WP 0459).
  - If there is no continuity, repair wire 2842 in main wire harness if repairable (TM 9-2320-325-14&P), or replace main wire harness (WP 0455).

## MALFUNCTION

## TEST OR INSPECTION

## CORRECTIVE ACTION

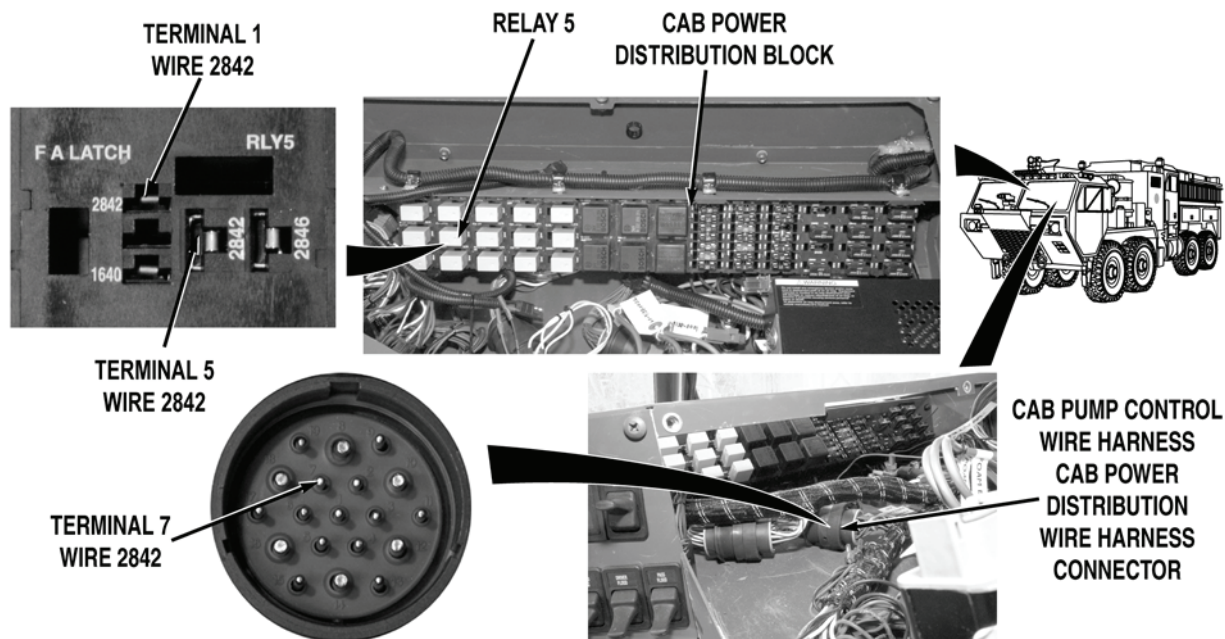
**WARNING**

Remove rings, wristwatches, neck chains, and any other jewelry before working around vehicle. Jewelry can catch on equipment and cause serious injury. Jewelry and tools may short across electrical circuits and cause damage to equipment, or severe burns or electrical shock to personnel.

- Step 12. Turn battery disconnect switch to OFF position (WP 0007). Disconnect cab pump control wire harness cab power distribution wire harness connector. With a test lead set, check for continuity across cab power distribution wire harness wire 2842 (red) from cab pump control wire harness cab power distribution wire harness connector, terminal 7 to cab power distribution block relay 5, terminals 1 or 5.
- a. If there is continuity, repair wire 2842 in cab pump control wire harness if repairable (TM 9-2320-325-14&P), or replace cab pump control wire harness (WP 0443).
  - b. If there is no continuity, repair wire 2842 in cab power distribution wire harness if repairable (TM 9-2320-325-14&P), or replace cab power distribution wire harness and block (WP 0441).

---

**MALFUNCTION**  
**TEST OR INSPECTION**  
**CORRECTIVE ACTION**

---

**PERSONNEL CAB FOAM A  
INDICATOR**

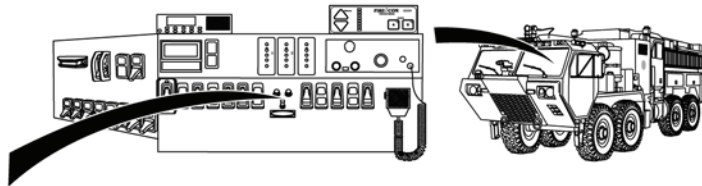

- Step 13. Put personnel cab FOAM SELECT switch to B position and back to A position (WP 0004). Check if personnel cab foam A indicator illuminates.

If personnel cab foam A indicator illuminates, go to Step 15.

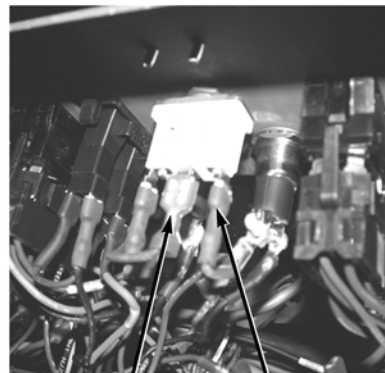
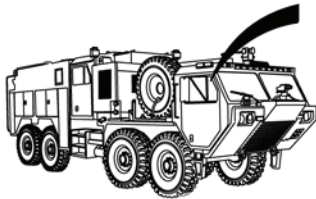

**TERMINAL  
WIRE 2830**

**TERMINAL  
WIRE 2842**

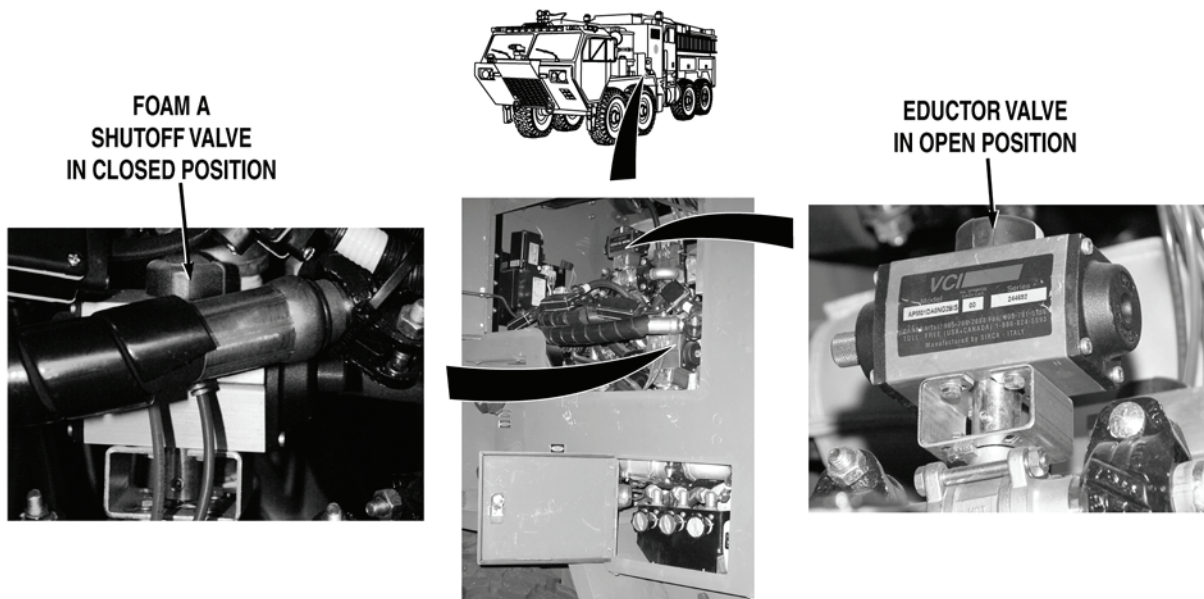

- Step 14. Turn battery disconnect switch to OFF position (WP 0007). Remove personnel cab instrument panel B (WP 0311). While an assistant holds personnel cab FOAM SELECT switch in A position (WP 0004), check for continuity across switch from terminal wire 2830 (red) to terminal wire 2842 (red).
- a. If there is continuity, repair wire 2830 in cab pump control wire harness if repairable (TM 9-2320-325-14&P), or replace cab pump control wire harness (WP 0443).
  - b. If there is no continuity, replace personnel cab FOAM SELECT switch (WP 0308).

**MALFUNCTION****TEST OR INSPECTION****CORRECTIVE ACTION****NOTE**

- Ensure system air pressure is at least 85 psi (586 kPa) during this procedure. System air pressure is required to activate valves.
- Do not engage water pump engine during this procedure, except when performing complete system checks. Valve operations can be checked without water pump operation.
- Valve operations can be checked by observing valve shaft rotation. Valves are open when tabs or yellow paint tabs are aligned with direction of fluid flow.

Step 15. Open pump house panel A (WP 0539). Check if eductor valve is in open position.

If eductor valve is not in open position, troubleshoot Foam Not Delivered From All Systems (Bumper Turret, Ground Sweeps, and Manual Metering Controls) or System Does Not Shut Off (WP 0094).

Step 16. While an assistant puts pump operator's panel FOAM TANK switch to "B" position and back to "A" position (WP 0004), check if foam A shutoff valve operates to closed and open position.

If foam A shutoff valve does not operate to closed and open positions, go to Step 18.

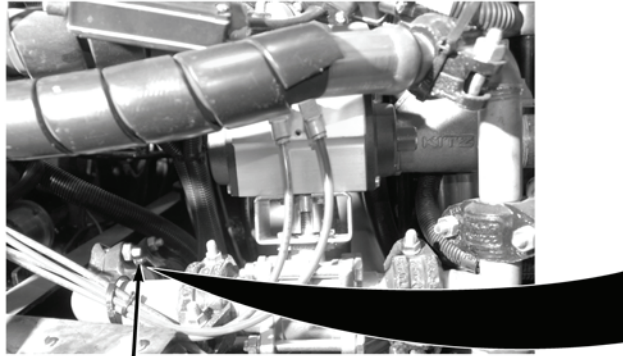
**MALFUNCTION****TEST OR INSPECTION****CORRECTIVE ACTION**

FOAM A  
CHECK VALVE

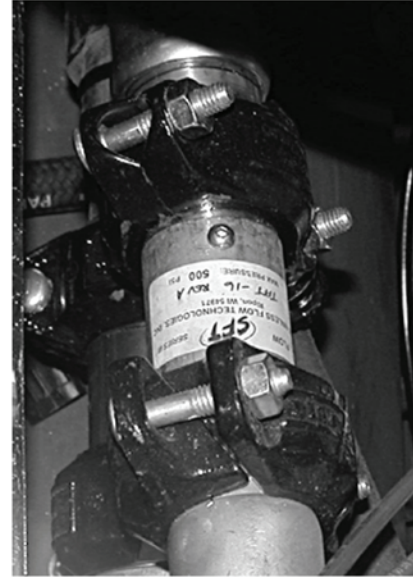
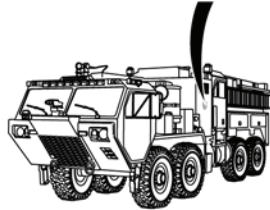

- Step 17. Turn battery disconnect switch to OFF position (WP 0007). Drain foam A tank (WP 0031). Remove foam system A check valve (WP 0282). Check foam A check valve for blockage and/or damage.
- a. If foam A check valve has blockage, remove blockage and reinstall foam A check valve (WP 0282). If foam check valve is damaged, replace foam A check valve (WP 0282).
  - b. If foam A check valve is not blocked or damaged, replace foam system A shutoff valve (WP 0284).

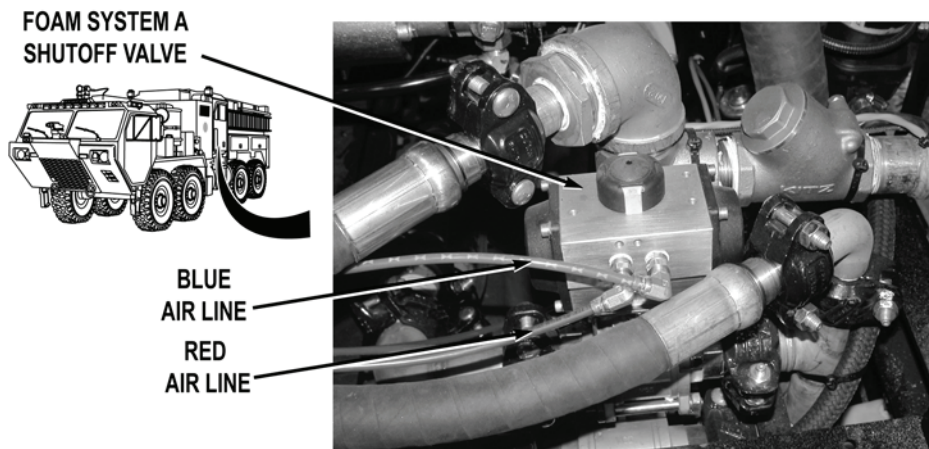
**MALFUNCTION****TEST OR INSPECTION****CORRECTIVE ACTION**

- Step 18. Check red and blue air lines from shutoff control valve manifold (WP 0567) to foam system A shutoff valve for leaks, kinks, or damage.

If air lines leak, are kinked, and/or damaged, replace air lines from shutoff control valve manifold to foam system A shutoff valve (WP 0567).

**WARNING**

**Air lines may be under pressure when control valve is operated. If under pressure and air lines are disconnected, air lines may whip around and cause injury to personnel. Caution should be exercised when operating control valve with air lines disconnected.**

**NOTE**

Air pressure is checked by disconnecting air lines at foam system A shutoff valve and observing air pressure escaping from air lines when foam system A shutoff valve is activated. Air will escape from blue air line when FOAM TANK switch is put to "A" position, and escape from red air line when FOAM SYSTEM switch is put to OFF position. System air pressure may drop below 85 psi (586 kPa) during this procedure.

- Step 19. Disconnect red air line from foam system A shutoff valve (WP 0567). Put pump operator's panel FOAM TANK switch to "B" position (WP 0004). Disconnect blue air line from foam system A shutoff valve (WP 0567). While an assistant puts FOAM TANK switch to "A" position (WP 0004), check for air pressure at foam system A shutoff valve.

If air pressure is present, replace foam system A shutoff valve (WP 0284).

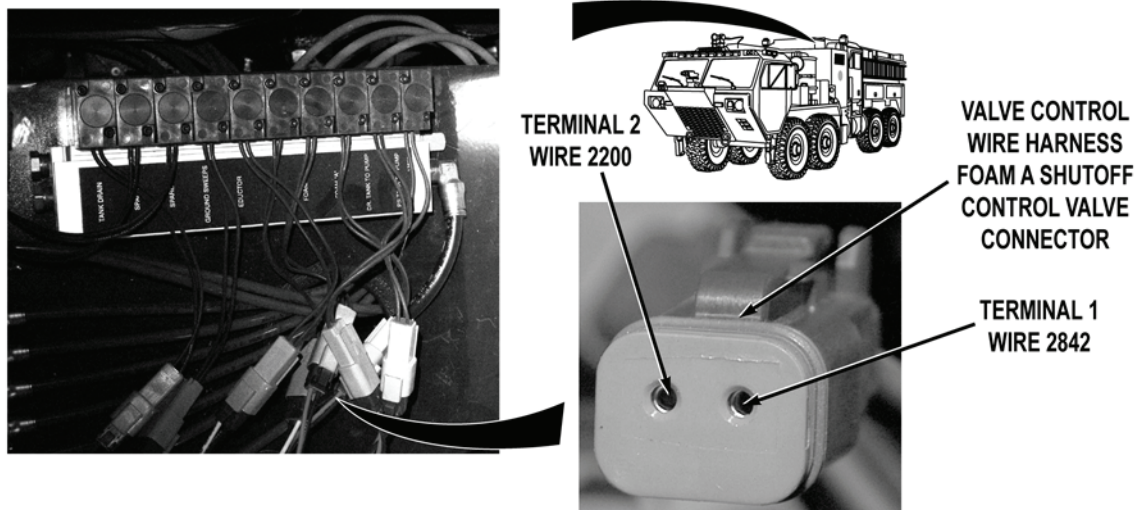
**MALFUNCTION****TEST OR INSPECTION****CORRECTIVE ACTION****WARNING**

Remove rings, wristwatches, neck chains, and any other jewelry before working around vehicle. Jewelry can catch on equipment and cause serious injury. Jewelry and tools may short across electrical circuits and cause damage to equipment, or severe burns or electrical shock to personnel.

- Step 20. Remove pump house panel S (WP 0540). Turn battery disconnect switch to OFF position (WP 0007). Disconnect valve control wire harness foam A shutoff control valve connector. Turn battery disconnect switch to ON position (WP 0007). Put pump operator's panel FOAM SYSTEM switch to ON position (WP 0004). Put pump operator's panel FOAM TANK switch to "A" position (WP 0004). With a test lead set, check for 22 to 28 VDC between wire 2842 (red) from valve control wire harness foam A shutoff control valve connector, terminal 1 to a known good ground.

If 22 to 28 VDC are not present, go to Step 23.

- Step 21. Turn battery disconnect switch to OFF position (WP 0007). With a test lead set, check for continuity across wire 2200 (black) from valve control wire harness foam A shutoff control valve connector, terminal 2 to a known good ground.

If there is continuity, replace shutoff control valve manifold (WP 0427).

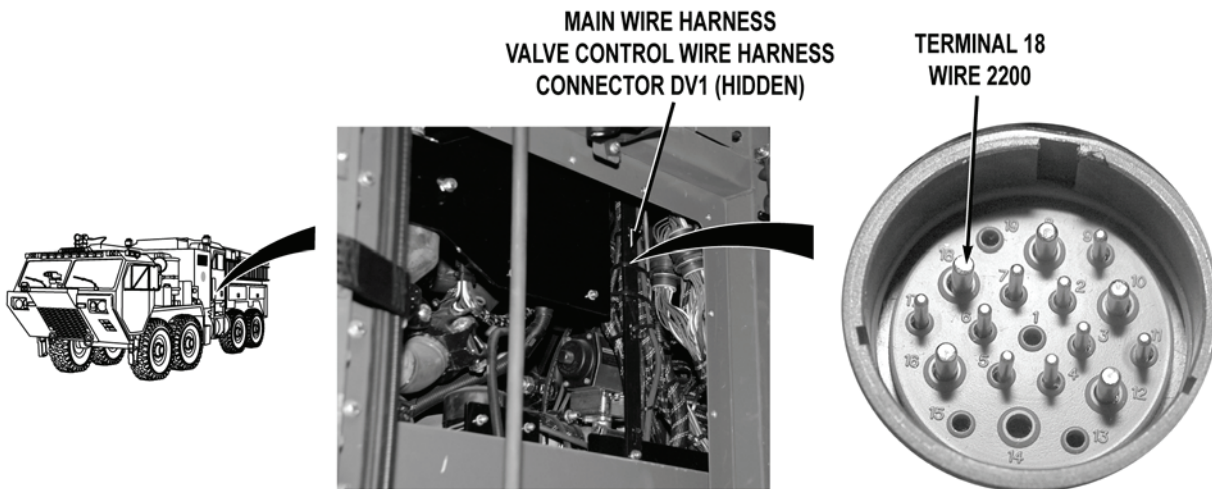
**MALFUNCTION****TEST OR INSPECTION****CORRECTIVE ACTION**

- Step 22. Remove pump house panel Q (WP 0540). Remove driver side crew cab access panel (WP 0499). Disconnect main wire harness valve control wire harness connector DV1. With a test lead set, check for continuity across main wire harness wire 2200 (black) from main wire harness valve control wire harness connector DV1, terminal 18 to a known good ground.
- a. If there is continuity, repair wire 2200 in valve control wire harness if repairable (TM 9-2320-325-14&P), or replace valve control wire harness (WP 0463).
  - b. If there is no continuity, repair wire 2200 in main wire harness if repairable (TM 9-2320-325-14&P), or replace main wire harness (WP 0455).



## MALFUNCTION

## TEST OR INSPECTION

## CORRECTIVE ACTION

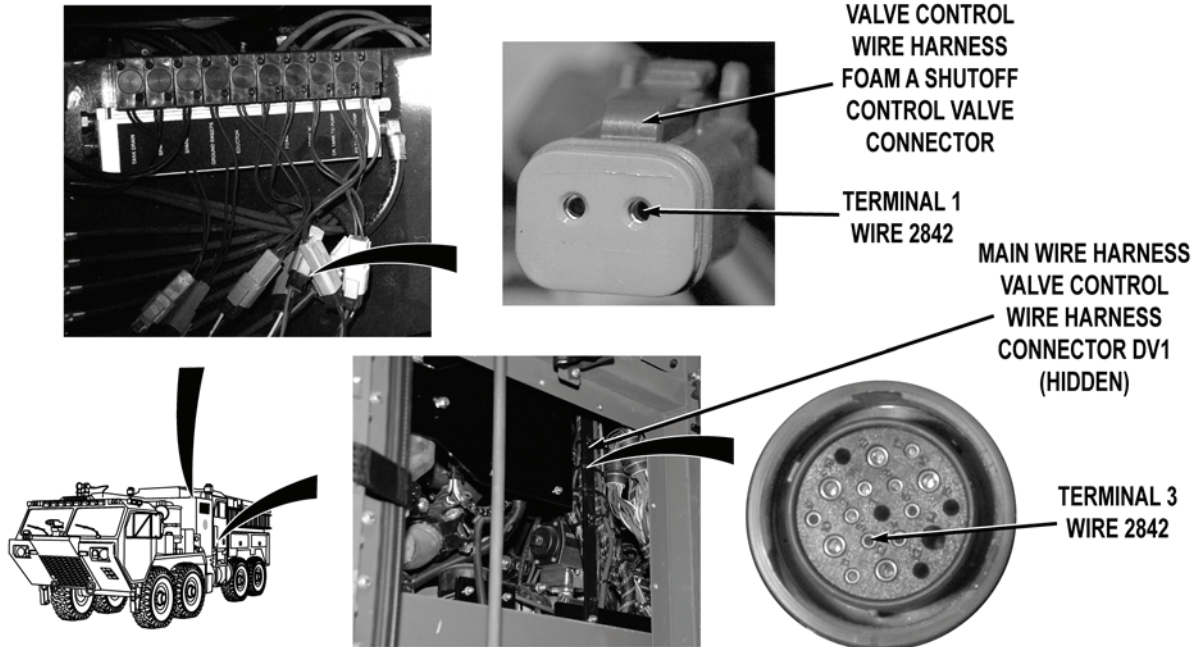
**WARNING**

Remove rings, wristwatches, neck chains, and any other jewelry before working around vehicle. Jewelry can catch on equipment and cause serious injury. Jewelry and tools may short across electrical circuits and cause damage to equipment, or severe burns or electrical shock to personnel.

- Step 23. Turn battery disconnect switch to OFF position (WP 0007). Remove driver side crew cab access panel (WP 0499). Remove pump house panel Q (WP 0540). Disconnect main wire harness valve control wire harness connector DV1. With a test lead set, check for continuity across valve control wire harness wire 2842 (red) from main wire harness valve control wire harness connector DV1, terminal 3 to valve control wire harness foam A shutoff control valve connector, terminal 1.
- a. If there is continuity, repair wire 2842 in main wire harness if repairable (TM 9-2320-325-14&P), or replace main wire harness (WP 0455).
  - b. If there is no continuity, repair wire 2842 in valve control wire harness if repairable (TM 9-2320-325-14&P), or replace valve control wire harness (WP 0463).

**MALFUNCTION**

**TEST OR INSPECTION**

**CORRECTIVE ACTION**



**FOAM B  
INDICATOR**

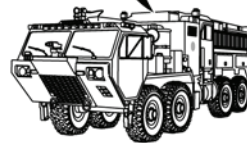

Step 24. Put pump operator's panel FOAM TANK switch to "B" position (WP 0004). Check if foam B indicator illuminates (WP 0004).

If foam B indicator illuminates, go to Step 26.



**TERMINAL  
WIRE 2830**



**FOAM TANK  
SWITCH**

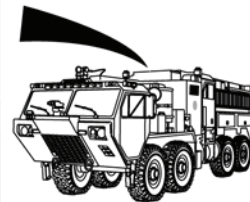

Step 25. Turn battery disconnect switch to OFF position (WP 0007). Open pump operator's panel housing (WP 0325). Turn battery disconnect switch to ON position (WP 0007). Put pump operator's panel FOAM SYSTEM switch to ON position (WP 0004). Check for 22 to 28 VDC between wire 2830 (red) at FOAM TANK switch, terminal to a known good ground.

- a. If 22 to 28 VDC are present, replace pump operator's panel FOAM TANK switch (WP 0337).
- b. If 22 to 28 VDC are not present, repair wire 2830 in pump operator's panel wire harness if repairable (TM 9-2320-325-14&P), or replace pump operator's panel wire harness (WP 0459).

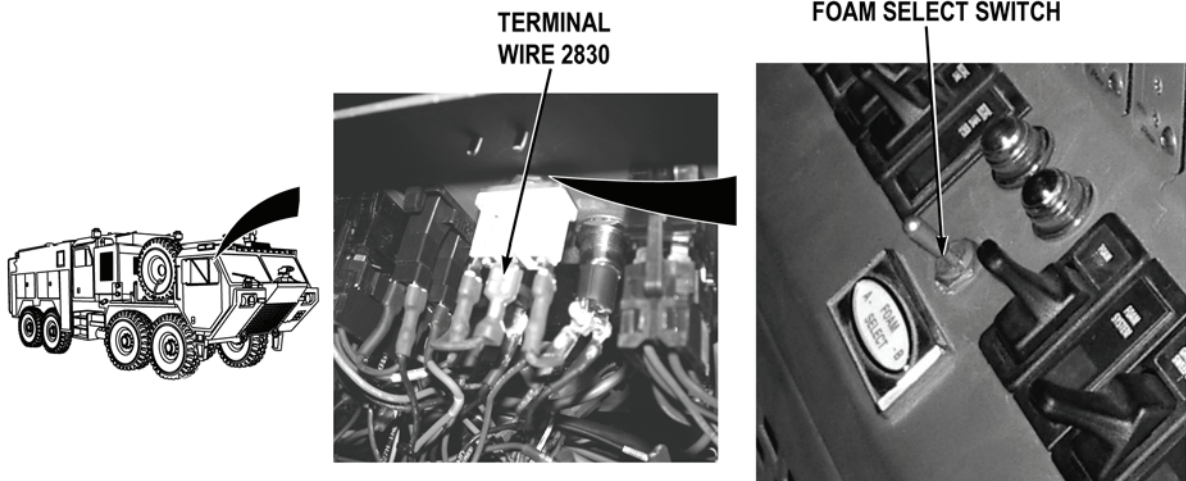
**MALFUNCTION****TEST OR INSPECTION****CORRECTIVE ACTION**

- Step 26. Turn battery disconnect switch to OFF position (WP 0007). Remove personnel cab instrument panel B (WP 0311). Turn battery disconnect switch to ON position (WP 0007). Put personnel cab FOAM SYSTEM switch to on position (WP 0004). Check for 22 to 28 VDC between wire 2830 (red) from personnel cab FOAM SELECT switch, terminal to a known good ground.
- a. If 22 to 28 VDC are present, replace personnel cab FOAM SYSTEM switch (WP 0315).
  - b. If 22 to 28 VDC are not present, repair wire 2830 in cab pump control wire harness if repairable (TM 9-2320-325-14&P), or replace cab pump control wire harness (WP 0443).

**END OF TASK****FOLLOW-ON MAINTENANCE**

1. Install skid plate grille if removed (WP 0550)
2. Remove wheel chocks (TM 9-2320-347-10)

**END OF TASK****END OF WORK PACKAGE**



**FIELD LEVEL MAINTENANCE**

**FOAM NOT DELIVERED WHEN TANK B IS SELECTED (BUMPER TURRET, UNDER TRUCK NOZZLES, AND MANUAL METERING CONTROLS)**

**INITIAL SETUP:**

**Tools and Special Tools**

- Lead Set, Test (WP 0622, Item 21)
- Tool Kit, General Mechanic's: Automotive (WP 0622, Item 27)

**Personnel Required**

- MOS 63B Wheeled vehicle mechanic (2)

**References**

- TM 9-2320-325-14&P
- WP 0004
- WP 0007
- WP 0019
- WP 0031
- WP 0094
- WP 0283
- WP 0285
- WP 0308
- WP 0311
- WP 0315

**References (continued)**

- WP 0325
- WP 0337
- WP 0402
- WP 0427
- WP 0441
- WP 0443
- WP 0455
- WP 0459
- WP 0463
- WP 0499
- WP 0539
- WP 0540
- WP 0550
- WP 0567

**Equipment Conditions**

- Water pump engine OFF (WP 0022)
- Engine OFF (TM 9-2320-347-10)
- Wheels chocked (TM 9-2320-347-10)

**MALFUNCTION**

**TEST OR INSPECTION**

**CORRECTIVE ACTION**

**FOAM NOT DELIVERED WHEN TANK B IS SELECTED (BUMPER TURRET, UNDER TRUCK NOZZLES, AND MANUAL METERING CONTROLS)**

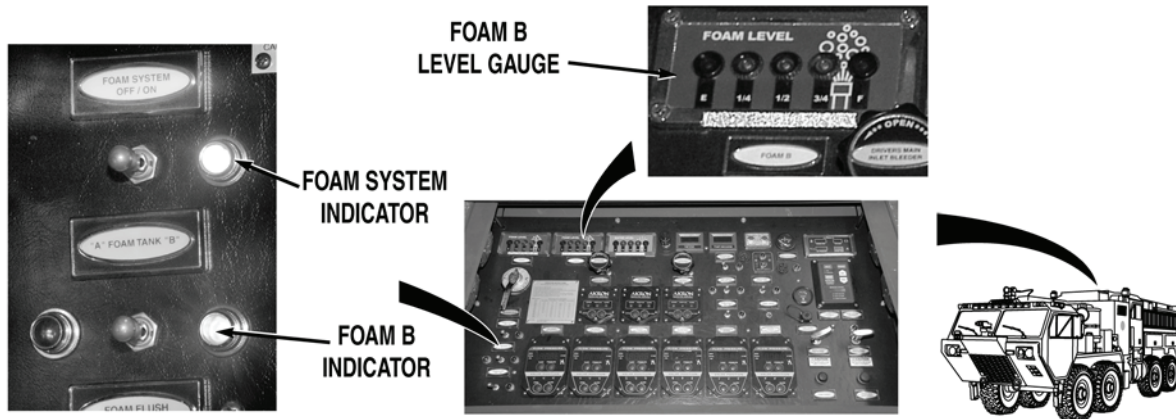
**MALFUNCTION****TEST OR INSPECTION****CORRECTIVE ACTION**

**⚠ CAUTION**

**Do not mix different types or brands of foam agent in foam tanks or piping. Mixing of different foam agents (either type or manufacturer) may cause deterioration of foam agent, improper proportioning and poor performance in a fire situation. Mixing of Class A and Class B foam agents may result in a chemical reaction which can create globules, which can clog orifices and cause system failure.**

- Step 1. Turn battery disconnect switch to ON position (WP 0007). Open pump operator's panel (WP 0019). Check level indicated at pump operator's panel FOAM B LEVEL gauge (WP 0004).
- If FOAM B LEVEL gauge indicated E (empty), fill foam A tank (WP 0031).
- Step 2. Put pump operator's panel FOAM SYSTEM switch to ON position (WP 0004). Check if FOAM SYSTEM indicator illuminates (WP 0004).
- If FOAM SYSTEM indicator does not illuminate, troubleshoot Foam Not Delivered From All Systems (Bumper Turret, Ground Sweeps, and Manual Metering Controls) or System Does Not Shut Off (WP 0094).
- Step 3. Put and hold pump operator's panel FOAM TANK switch to "B" position (WP 0004). Check if foam B indicator illuminates (WP 0004).
- If foam B indicator does not illuminate, go to Step 24.
- Step 4. Release pump operator's panel FOAM TANK switch (WP 0004). Check if foam B indicator remains illuminated.
- If foam B indicator remains illuminated, go to Step 13.

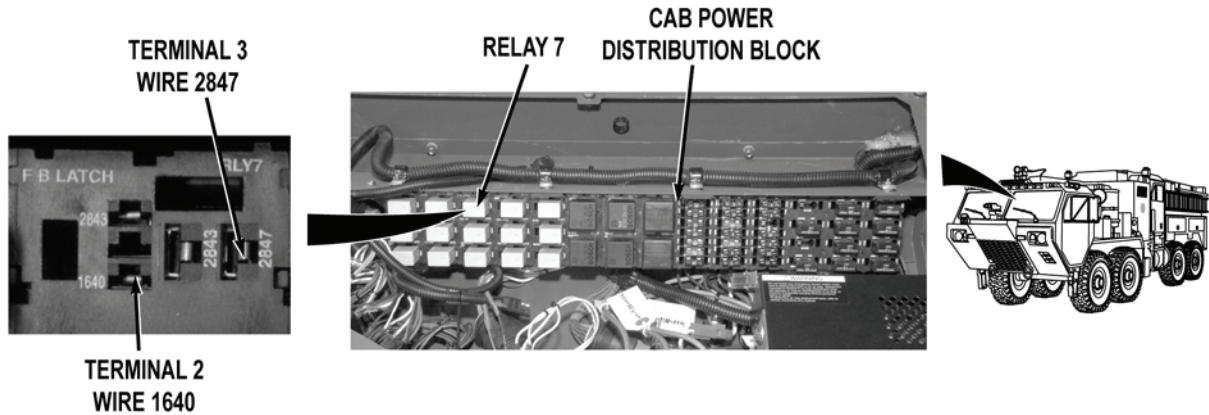
**MALFUNCTION****TEST OR INSPECTION****CORRECTIVE ACTION****WARNING**

**Remove rings, wristwatches, neck chains, and any other jewelry before working around vehicle. Jewelry can catch on equipment and cause serious injury. Jewelry and tools may short across electrical circuits and cause damage to equipment, or severe burns or electrical shock to personnel.**

- Step 5. Turn battery disconnect switch to OFF position (WP 0007). Remove personnel cab instrument panel A (WP 0311). Remove relay 7 from cab power distribution block (WP 0402). Turn battery disconnect switch to ON position (WP 0007). Put personnel cab FOAM SYSTEM switch to on position (WP 0004). Check for 22 to 28 VDC between wire 2847 (white) from cab power distribution block relay 7, terminal 3 to a known good ground.

If 22 to 28 VDC are not present, go to Step 12.

- Step 6. Turn battery disconnect switch to OFF position (WP 0007). Check for continuity across wire 1640 (black) from cab power distribution block relay 7, terminal 2 to a known good ground.

If there is no continuity, replace cab power distribution wire harness and block (WP 0441).

## MALFUNCTION

## TEST OR INSPECTION

## CORRECTIVE ACTION

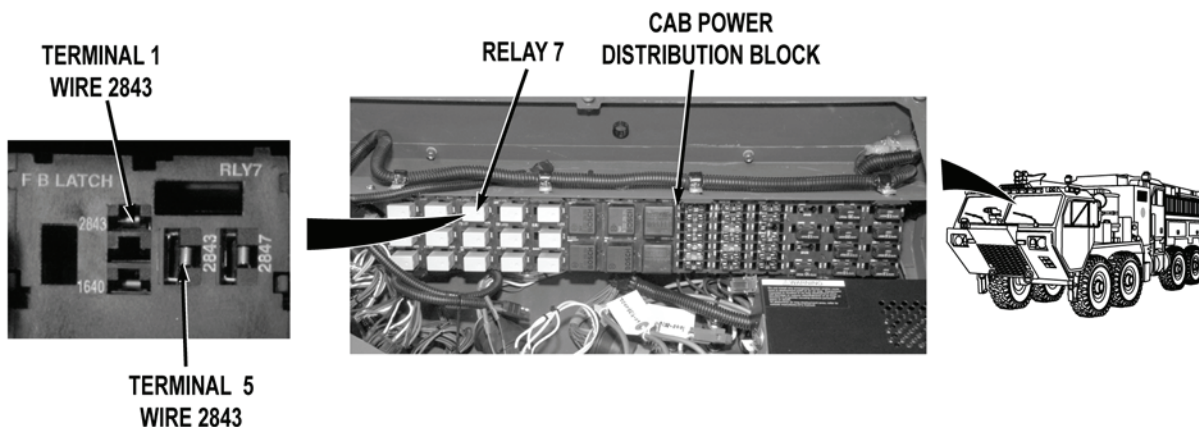

- Step 7. Turn battery disconnect switch to ON position (WP 0007). Put pump operator's panel FOAM SYSTEM switch to ON position (WP 0004). While an assistant holds pump operator's panel FOAM TANK switch to "B" position (WP 0004), check for 22 to 28 VDC across cab power distribution wire harness wire 2843 (red) from cab power distribution block relay 7, terminals 1 and 5 to a known good ground.
- If 22 to 28 VDC are present at both terminals, replace relay 7 (WP 0402).
  - If 22 to 28 VDC are present at one but not both terminals, replace cab power distribution wire harness and block (WP 0441).
  - If 22 to 28 VDC are not present, go to Step 8.

**WARNING**

**Remove rings, wristwatches, neck chains, and any other jewelry before working around vehicle. Jewelry can catch on equipment and cause serious injury. Jewelry and tools may short across electrical circuits and cause damage to equipment, or severe burns or electrical shock to personnel.**

- Step 8. While an assistant puts and holds personnel cab FOAM SELECT switch to "B" position (WP 0004), check for 22 to 28 VDC across wire 2843 (red) from cab power distribution block relay 7, terminals 1 or 5 to a known good ground.

If 22 to 28 VDC are present, go to Step 10.



## MALFUNCTION

## TEST OR INSPECTION

## CORRECTIVE ACTION

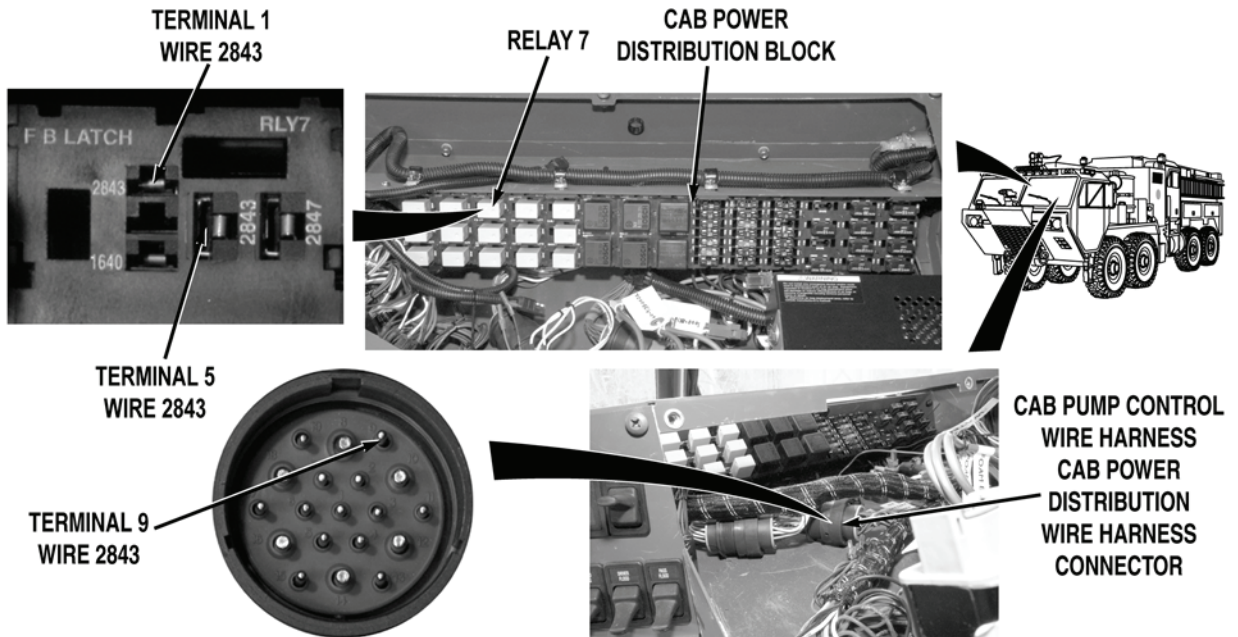

- Step 9. Turn battery disconnect switch to OFF position (WP 0007). Disconnect cab pump control wire harness cab power distribution wire harness connector. With a test lead set, check for continuity across cab power distribution wire harness wire 2843 (red) from cab pump control wire harness cab power distribution wire harness connector, terminal 9 to cab power distribution block relay 7, terminals 1 or 5.
- a. If there is continuity, repair wire 2843 in cab pump control wire harness if repairable (TM 9-2320-325-14&P), or replace cab pump control wire harness (WP 0443).
  - b. If there is no continuity, repair wire 2843 in cab power distribution wire harness if repairable (TM 9-2320-325-14&P), or replace cab power distribution wire harness and block (WP 0441).

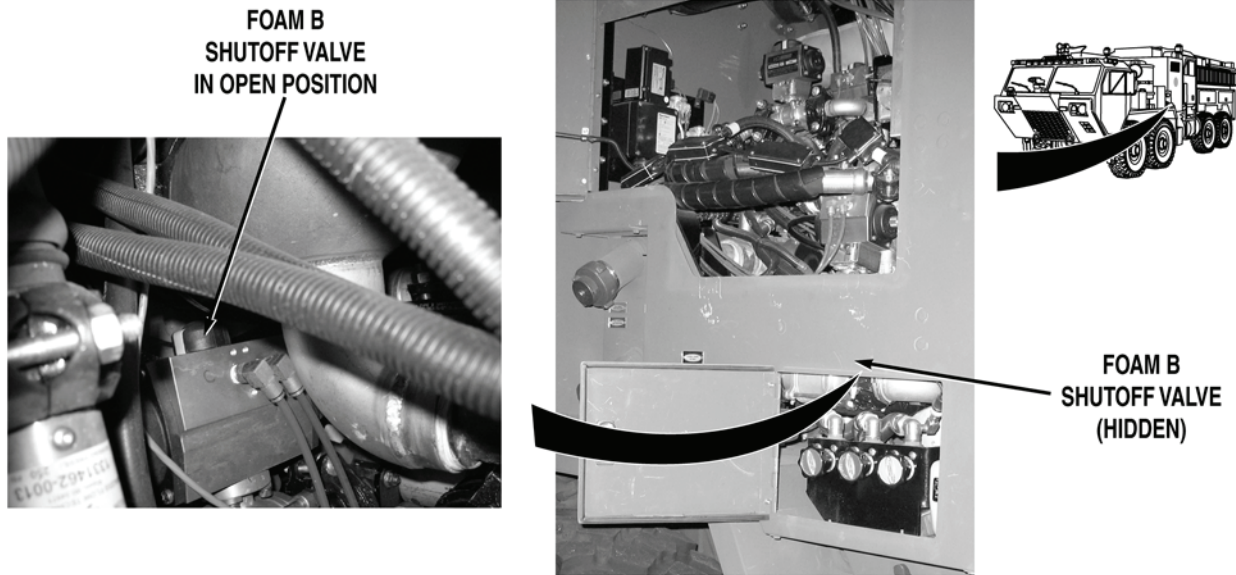
**MALFUNCTION****TEST OR INSPECTION****CORRECTIVE ACTION****NOTE**

- Ensure system air pressure is at least 85 psi (586 kPa) during this procedure. System air pressure is required to activate valves.
- Do not engage water pump engine during this procedure, except when performing complete system checks. Valve operations can be checked without water pump operation.
- Valve operations can be checked by observing valve shaft rotation. Valves are open when tabs or yellow paint tabs are aligned with direction of fluid flow.

Step 10. Open pump house panel A (WP 0539). While an assistant puts and holds pump operator's panel FOAM TANK switch to "B" position (WP 0004), check if foam B shutoff valve operates to open position.

If foam B shutoff valve operates to open position, repair wire 2843 (red) in main wire harness if repairable (TM 9-2320-325-14&P), or replace main wire harness (WP 0455).

**MALFUNCTION**

**TEST OR INSPECTION**

**CORRECTIVE ACTION**

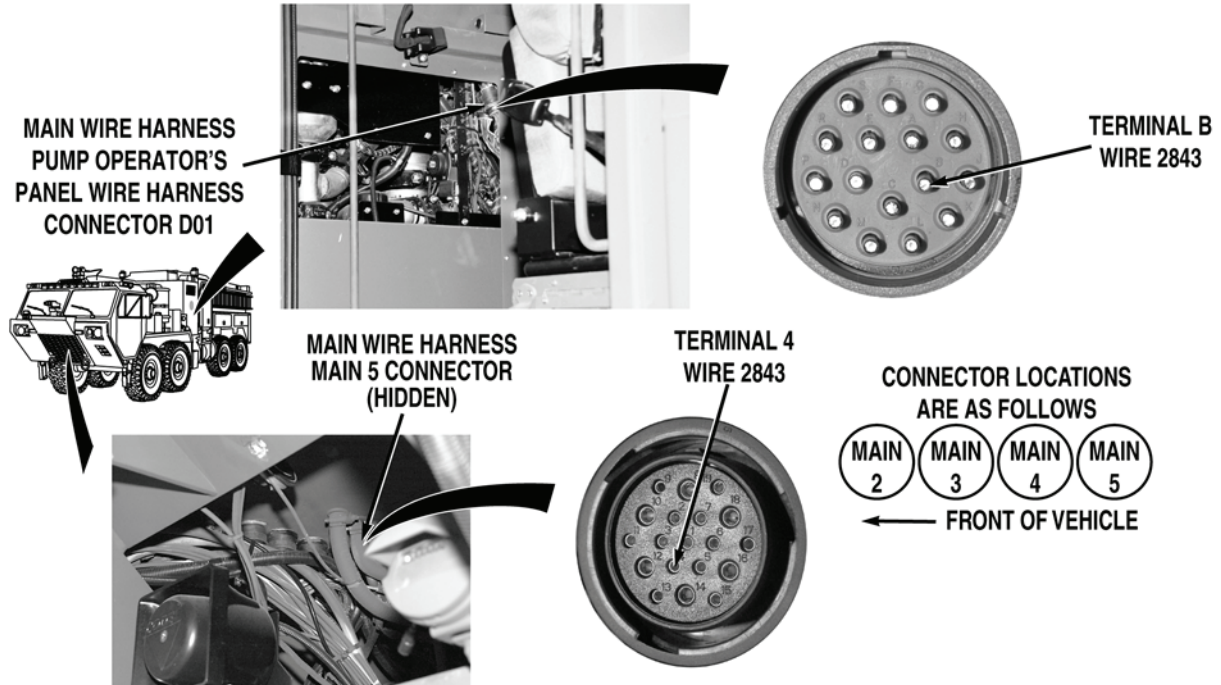

- Step 11. Remove skid plate grille (WP 0550). Disconnect main wire harness main 5 connector. Remove driver side crew cab access panel (WP 0499). Remove pump house panel Q (WP 0540). Disconnect main wire harness pump operator's panel wire harness connector DO1. With a test lead set, check for continuity across main wire harness wire 2843 (red) from main wire harness main 5 connector, terminal 4 to main wire harness pump operator's panel wire harness connector DO1, terminal B.
- a. If there is continuity, repair wire 2843 in pump operator's panel wire harness if repairable (TM 9-2320-325-14&P), or replace pump operator's panel wire harness (WP 0459).
  - b. If there is no continuity, repair wire 2843 in main wire harness if repairable (TM 9-2320-325-14&P), or replace main wire harness (WP 0455).

## MALFUNCTION

## TEST OR INSPECTION

## CORRECTIVE ACTION

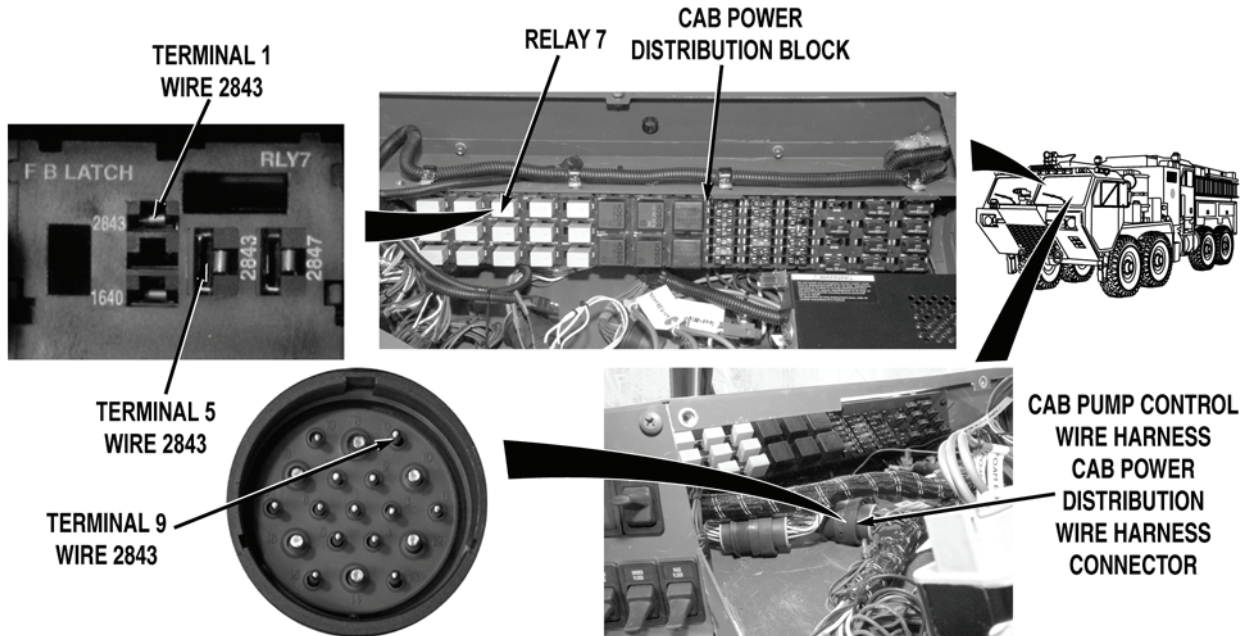
**WARNING**

Remove rings, wristwatches, neck chains, and any other jewelry before working around vehicle. Jewelry can catch on equipment and cause serious injury. Jewelry and tools may short across electrical circuits and cause damage to equipment, or severe burns or electrical shock to personnel.

- Step 12. Turn battery disconnect switch to OFF position (WP 0007). Disconnect cab pump control wire harness cab power distribution wire harness connector. With a test lead set, check for continuity across cab power distribution wire harness wire 2843 (red) from cab pump control wire harness cab power distribution wire harness connector, terminal 9 to cab power distribution block relay 7, terminals 1 or 5.
- a. If there is continuity, repair wire 2843 in cab pump control wire harness if repairable (TM 9-2320-325-14&P), or replace cab pump control wire harness (WP 0443).
  - b. If there is no continuity, repair wire 2843 in cab power distribution wire harness if repairable (TM 9-2320-325-14&P), or replace cab power distribution wire harness and block (WP 0441).

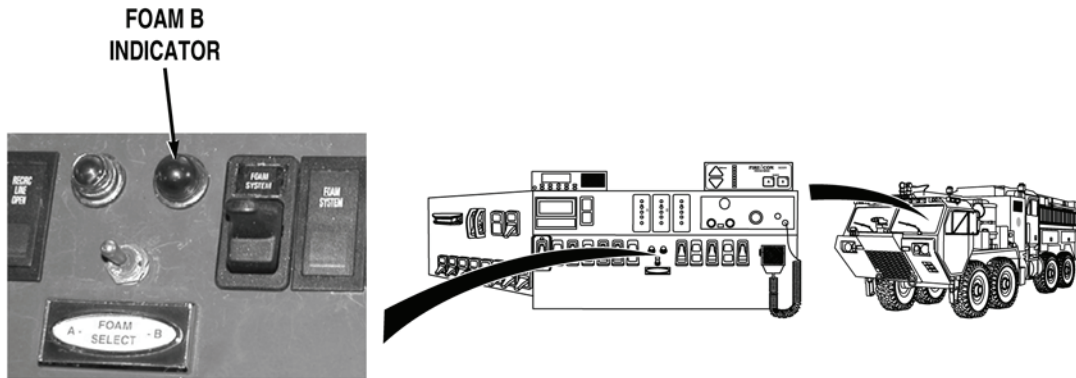
**MALFUNCTION****TEST OR INSPECTION****CORRECTIVE ACTION**

- Step 13. Put personnel cab FOAM SELECT switch to A position and back to B position (WP 0004). Check if personnel cab foam B indicator illuminates.

If personnel cab foam B indicator illuminates, go to Step 15.

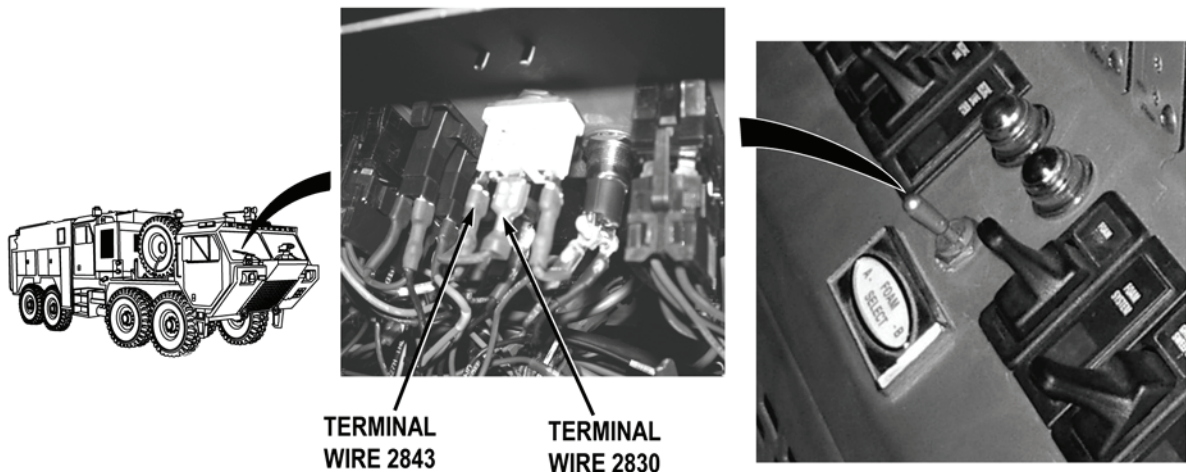

- Step 14. Turn battery disconnect switch to OFF position (WP 0007). Remove personnel cab instrument panel B (WP 0311). While an assistant holds personnel cab FOAM SELECT switch in B position (WP 0004), check for continuity across switch from terminal wire 2830 (red) to terminal wire 2843 (red).
- If there is continuity, repair wire 2830 in cab pump control wire harness if repairable (TM 9-2320-325-14&P), or replace cab pump control wire harness (WP 0443).
  - If there is no continuity, replace personnel cab FOAM SELECT switch (WP 0308).

**MALFUNCTION**

**TEST OR INSPECTION**

**CORRECTIVE ACTION**

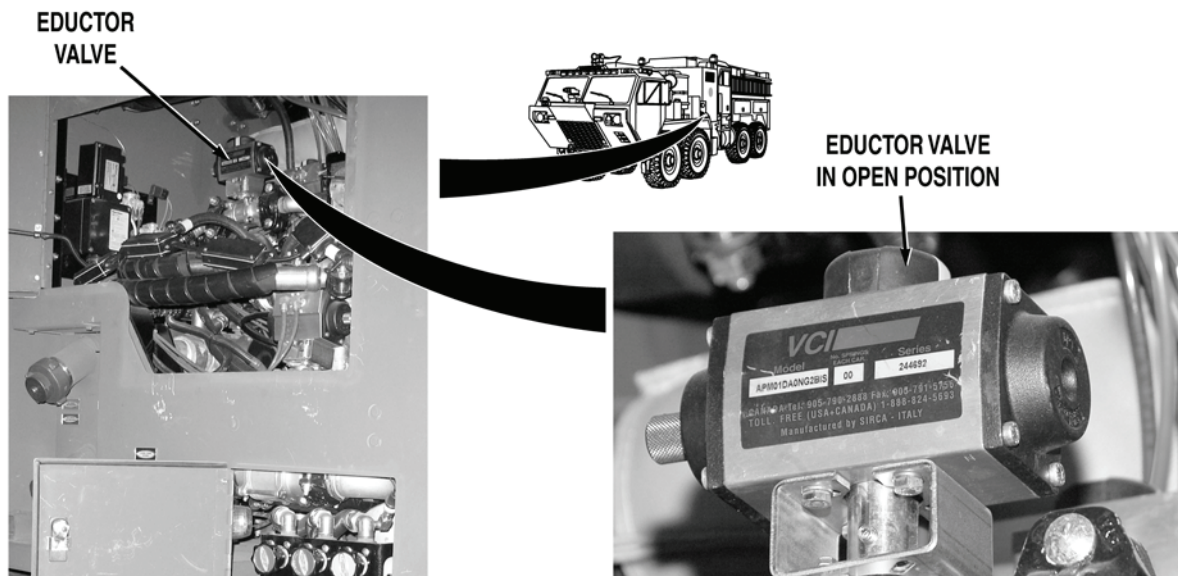

Step 15. Open pump house panel A (WP 0539). Check if eductor valve is in open position.

If eductor valve is not in open position, troubleshoot Foam Not Delivered From All Systems (Bumper Turret, Ground Sweeps, and Manual Metering Controls) or System Does Not Shut Off (WP 0094).

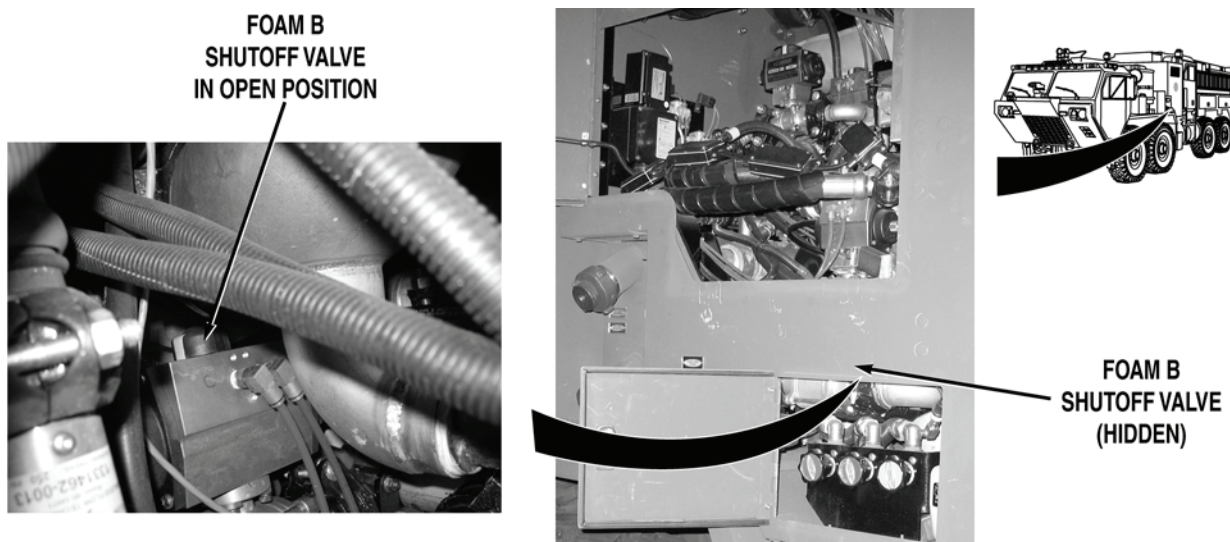

Step 16. While an assistant puts pump operator's panel FOAM TANK switch to "A" position and back to "B" position (WP 0004), check if foam B shutoff valve operates to closed and open position.

If foam B shutoff valve does not operate to closed and open positions, go to Step 18.

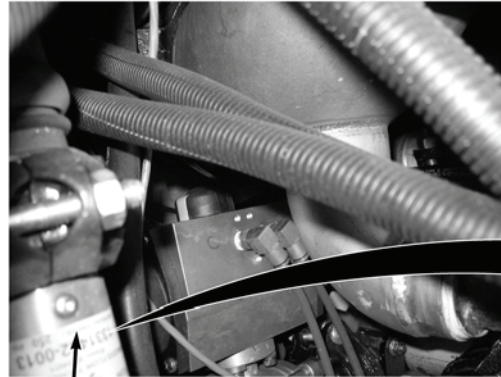
**MALFUNCTION****TEST OR INSPECTION****CORRECTIVE ACTION**

FOAM B  
CHECK VALVE

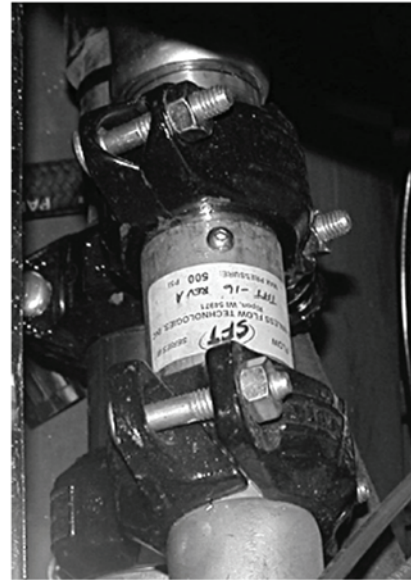
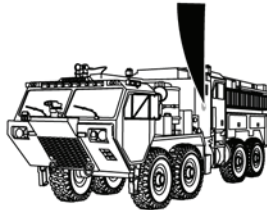

- Step 17. Turn battery disconnect switch to OFF position (WP 0007). Drain foam B tank (WP 0031). Remove foam system B check valve (WP 0283). Check foam B check valve for blockage and/or damage.
- a. If foam B check valve has blockage, remove blockage and reinstall foam B check valve (WP 0283). If foam check valve is damaged, replace foam B check valve (WP 0283).
  - b. If foam B check valve is not blocked or damaged, replace foam system B shutoff valve (WP 0285).

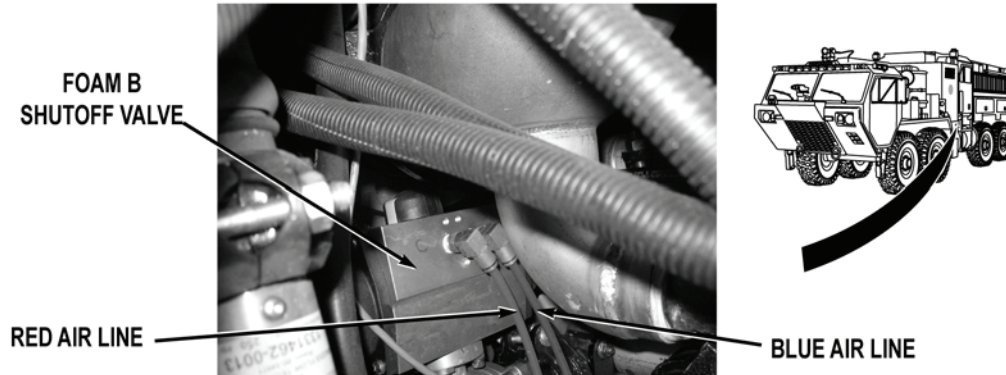
**MALFUNCTION****TEST OR INSPECTION****CORRECTIVE ACTION**

- Step 18. Check red and blue air lines from shutoff control valve manifold (WP 0567) to foam system B shutoff valve for leaks, kinks, or damage.

If air lines leak, are kinked, and/or damaged, replace air lines from shutoff control valve manifold to foam system B shutoff valve (WP 0567).

**WARNING**

**Air lines may be under pressure when control valve is operated. If under pressure and air lines are disconnected, air lines may whip around and cause injury to personnel. Caution should be exercised when operating control valve with air lines disconnected.**

**NOTE**

Air pressure is checked by disconnecting air lines at foam system B shutoff valve and observing air pressure escaping from air line, when foam system B shutoff control valve manifold is activated. Air will escape from blue air line when FOAM TANK switch is positioned to B position, and escape from red air line when the FOAM SYSTEM switch is positioned to OFF position.

- Step 19. Disconnect red air line from foam system B shutoff valve (WP 0567). Put pump operator's panel FOAM TANK switch to "A" position (WP 0004). Disconnect blue air line from foam system B shutoff valve (WP 0567). While an assistant puts FOAM TANK switch to "B" position (WP 0004), check for air pressure at foam system B shutoff valve.

If air pressure is present, replace foam system B shutoff valve (WP 0285).



---

**MALFUNCTION**  
**TEST OR INSPECTION**  
**CORRECTIVE ACTION**

---

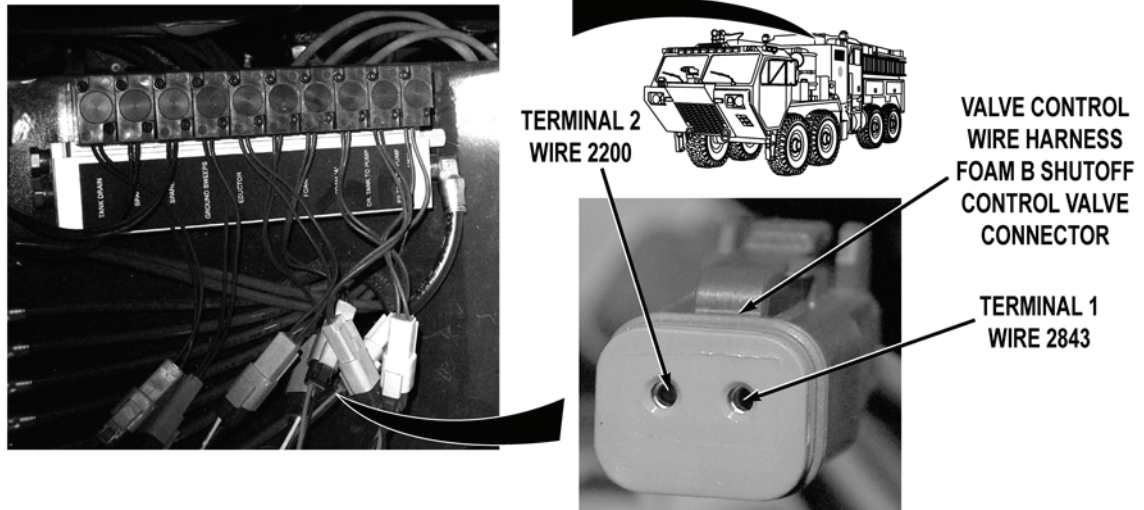

**WARNING**



Remove rings, wristwatches, neck chains, and any other jewelry before working around vehicle. Jewelry can catch on equipment and cause serious injury. Jewelry and tools may short across electrical circuits and cause damage to equipment, or severe burns or electrical shock to personnel.

- Step 20. Remove pump house panel S (WP 0540). Turn battery disconnect switch to OFF position (WP 0007). Disconnect valve control wire harness foam B shutoff control valve connector. Turn battery disconnect switch to ON position (WP 0007). Put pump operator's panel FOAM SYSTEM switch to ON position (WP 0004). Put pump operator's panel FOAM TANK switch to "B" position (WP 0004). With a test lead set, check for 22 to 28 VDC between wire 2843 (red) from valve control wire harness foam B shutoff control valve connector, terminal 1 to a known good ground.

If 22 to 28 VDC are not present, go to Step 23.

- Step 21. Turn battery disconnect switch to OFF position (WP 0007). With a test lead set, check for continuity across wire 2200 (black) from valve control wire harness foam A shutoff control valve connector, terminal 2 to a known good ground.

If there is continuity, replace shutoff control valve manifold (WP 0427).

---

**MALFUNCTION****TEST OR INSPECTION****CORRECTIVE ACTION**

---

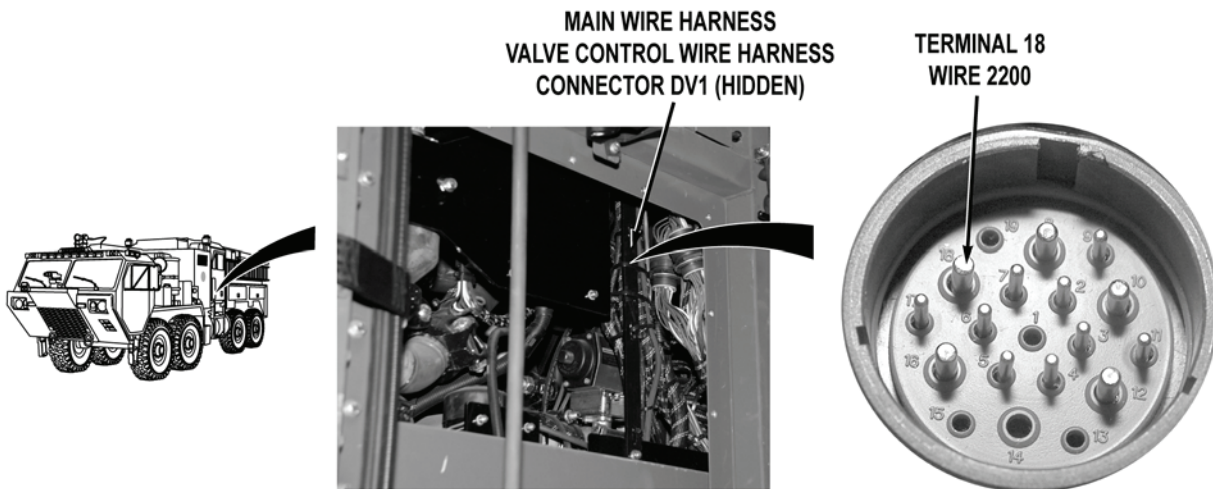

- Step 22. Remove pump house panel A (WP 0540). Remove driver side crew cab access panel (WP 0499). Disconnect main wire harness valve control wire harness connector DV1. With a test lead set, check for continuity across main wire harness wire 2200 (black) from main wire harness valve control wire harness connector DV1, terminal 18 to a known good ground.
- a. If there is continuity, repair wire 2200 in valve control wire harness if repairable (TM 9-2320-325-14&P), or replace valve control wire harness (WP 0463).
  - b. If there is no continuity, repair wire 2200 in main wire harness if repairable (TM 9-2320-325-14&P), or replace main wire harness (WP 0455).

---

**MALFUNCTION**  
**TEST OR INSPECTION**  
**CORRECTIVE ACTION**

---

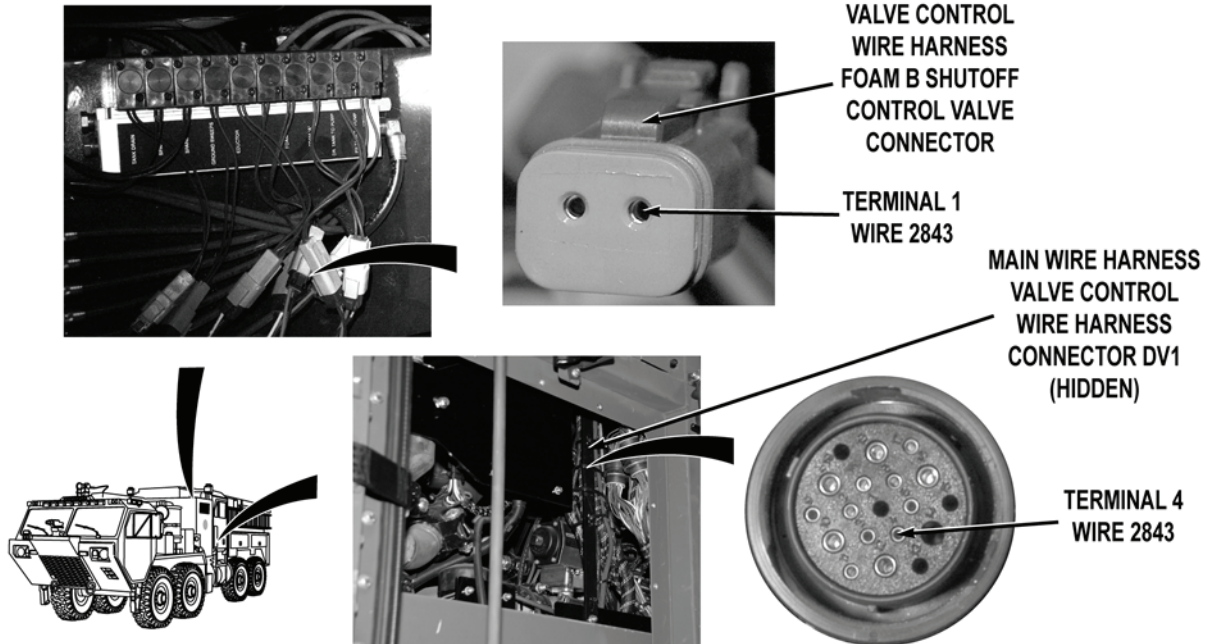

**WARNING**



**Remove rings, wristwatches, neck chains, and any other jewelry before working around vehicle. Jewelry can catch on equipment and cause serious injury. Jewelry and tools may short across electrical circuits and cause damage to equipment, or severe burns or electrical shock to personnel.**

- Step 23. Turn battery disconnect switch to OFF position (WP 0007). Remove driver side crew cab access panel (WP 0499). Remove pump house panel Q (WP 0540). Disconnect main wire harness valve control wire harness connector DV1. With a test lead set, check for continuity across valve control wire harness wire 2843 (red) from main wire harness valve control wire harness connector DV1, terminal 4 to valve control wire harness foam A shutoff control valve connector, terminal 1.
- a. If there is continuity, repair wire 2843 in main wire harness if repairable (TM 9-2320-325-14&P), or replace main wire harness (WP 0455).
  - b. If there is no continuity, repair wire 2843 in valve control wire harness if repairable (TM 9-2320-325-14&P), or replace valve control wire harness (WP 0463).

**MALFUNCTION**

**TEST OR INSPECTION**

**CORRECTIVE ACTION**

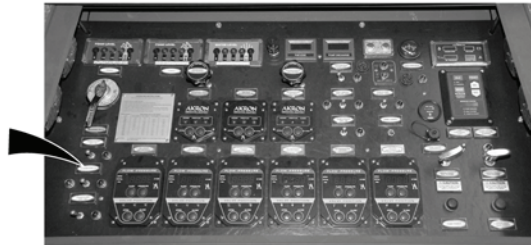
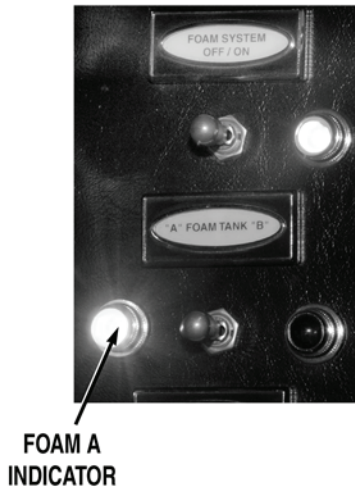

Step 24. Put pump operator's panel FOAM TANK switch to "A" position (WP 0004). Check if foam A indicator illuminates (WP 0004).

If foam A indicator illuminates, go to Step 26.

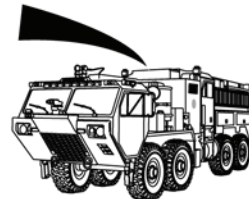

**FOAM TANK SWITCH**

Step 25. Turn battery disconnect switch to OFF position (WP 0007). Open pump operator's panel housing (WP 0325). Turn battery disconnect switch to ON position (WP 0007). Put pump operator's panel FOAM SYSTEM to ON position (WP 0004). Check for 22 to 28 VDC between wire 2830 (red) at FOAM TANK switch, terminal to a known good ground.

- a. If 22 to 28 VDC are present, replace pump operator's panel FOAM TANK switch (WP 0337).
- b. If 22 to 28 VDC are not present, repair wire 2830 in pump operator's panel wire harness if repairable (TM 9-2320-325-14&P), or replace pump operator's panel wire harness (WP 0459).

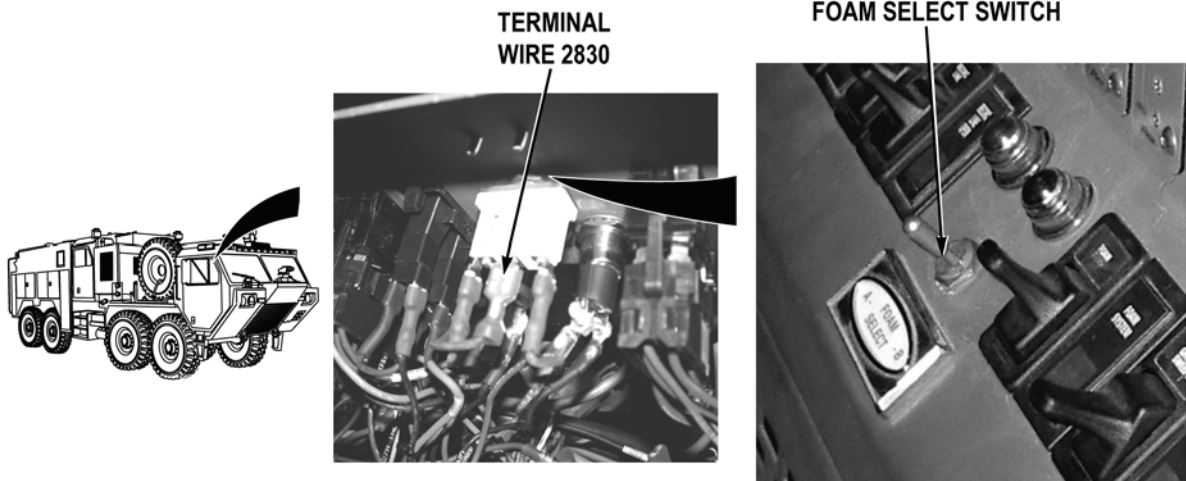
**MALFUNCTION****TEST OR INSPECTION****CORRECTIVE ACTION**

- Step 26. Turn battery disconnect switch to OFF position (WP 0007). Remove personnel cab instrument panel B (WP 0311). Turn battery disconnect switch to ON position (WP 0007). Put personnel cab FOAM SYSTEM switch to on position (WP 0004). Check for 22 to 28 VDC between wire 2830 (red) from personnel cab FOAM SELECT switch, terminal to a known good ground.
- a. If 22 to 28 VDC are present, replace personnel cab FOAM SYSTEM switch (WP 0315).
  - b. If 22 to 28 VDC are not present, repair wire 2830 in cab pump control wire harness if repairable (TM 9-2320-325-14&P), or replace cab pump control wire harness (WP 0443).

**END OF TASK****FOLLOW-ON MAINTENANCE**

1. Remove wheel chocks (TM 9-2320-347-10)
2. Install skid plate grille if removed (WP 0550)

**END OF TASK****END OF WORK PACKAGE**



**FIELD LEVEL MAINTENANCE**

**FOAM NOT DELIVERED FROM BUMPER TURRET**

**INITIAL SETUP:**

**Tools and Special Tools**

Lead Set, Test (WP 0622, Item 21)  
 Tool Kit, General Mechanic's: Automotive  
 (WP 0622, Item 27)

**Personnel Required**

MOS 63B Wheeled vehicle mechanic (2)

**References**

TM 9-2320-325-14&P  
 WP 0004  
 WP 0007  
 WP 0022  
 WP 0031  
 WP 0094

**References (continued)**

WP 0095  
 WP 0096  
 WP 0104  
 WP 0288  
 WP 0292  
 WP 0463  
 WP 0567  
 WP 0539  
 WP 0540

**Equipment Conditions**

Water pump engine OFF (WP 0022)  
 Engine OFF (TM 9-2320-347-10)  
 Wheels chocked (TM 9-2320-347-10)

**MALFUNCTION**

**TEST OR INSPECTION**

**CORRECTIVE ACTION**

**FOAM NOT DELIVERED FROM BUMPER TURRET**

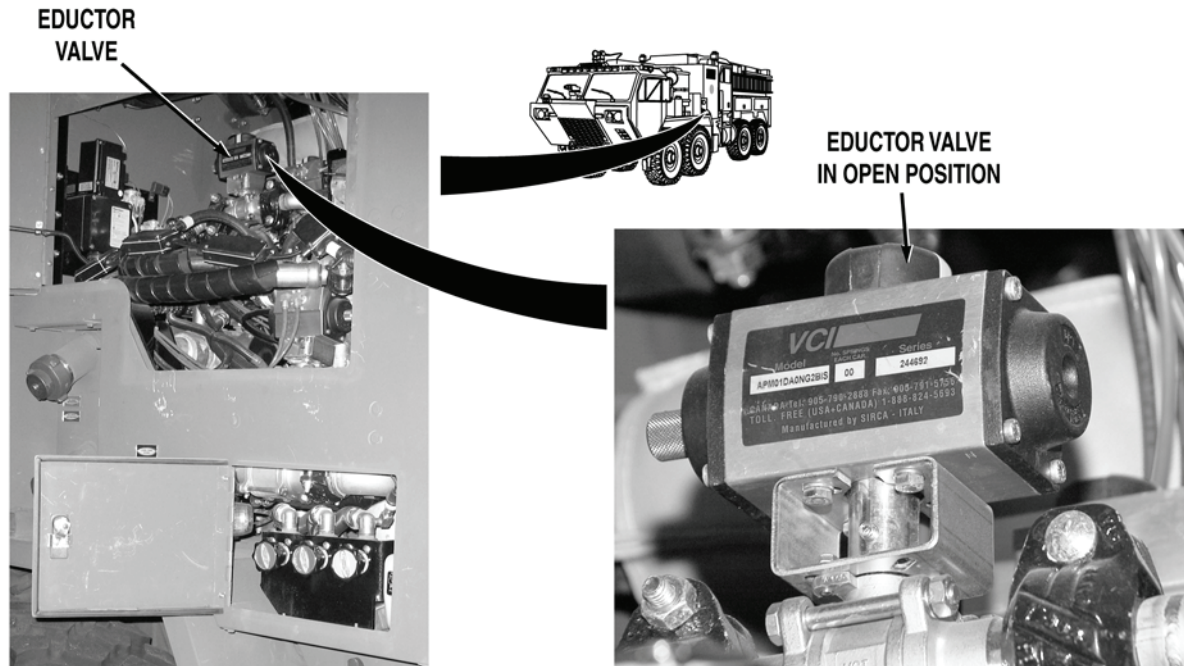
**MALFUNCTION****TEST OR INSPECTION****CORRECTIVE ACTION****NOTE**

- Ensure system air pressure is at least 85 psi (586 kPa) during this procedure. System air pressure is required to activate valves.
- Do not engage water pump engine during this procedure, except when performing complete system checks. Valve operations can be checked without water pump operation.
- Valve operations can be checked by observing valve shaft rotation. Valves are open when tabs or yellow paint tabs are aligned with direction of fluid flow.

Step 1. Turn battery disconnect switch to ON position (WP 0007). If system air pressure is below 85 psi (586 kPa), start engine and allow system air pressure to build to at least 85 psi (586 kPa) (TM 9-2320-347-10). Then turn engine off (TM 9-2320-347-10). Open pump house access door A (WP 0539). While an assistant puts pump operator's panel FOAM SYSTEM switch to on position (WP 0004), check if eductor valve operates open position.

If eductor valve does not operate to open position, troubleshoot Foam Not Delivered From All Systems (Bumper Turret, Ground Sweeps, and Manual Metering Controls) or System Does Not Shut Off (WP 0094).



---

**MALFUNCTION**  
**TEST OR INSPECTION**  
**CORRECTIVE ACTION**

---

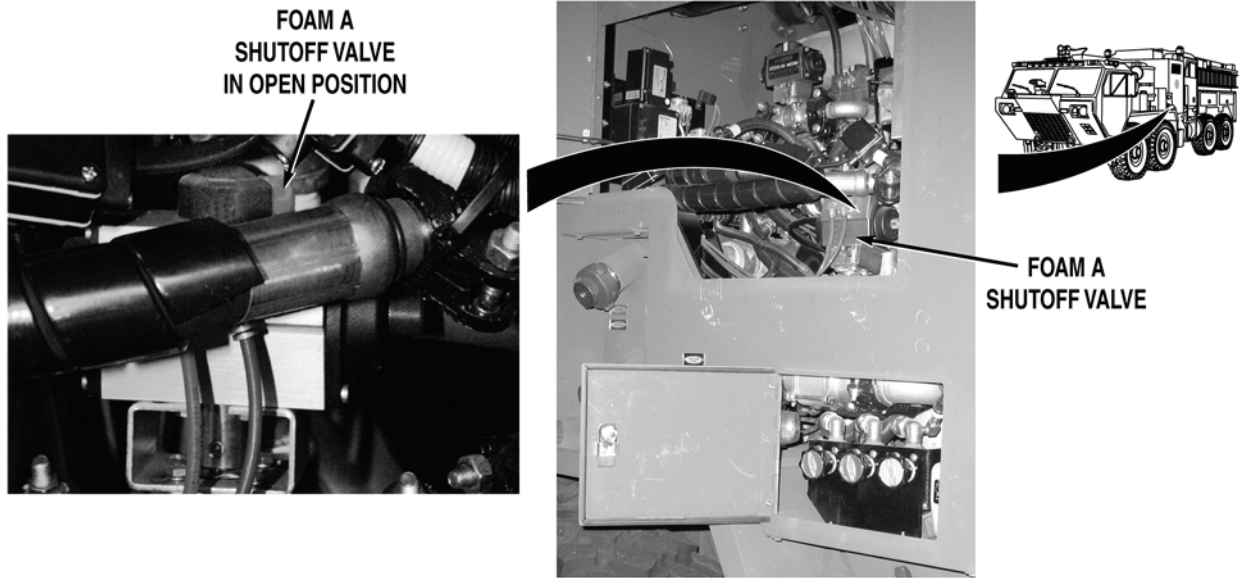

- Step 2. Put cab or pump operator's panel FOAM TANK switch to "A" position (WP 0004). While an assistant puts cab or pump operator's panel FOAM SYSTEM switch to on and off positions (WP 0004), check if foam A system shutoff valve operate to open position.

If foam A system shutoff valve does not operate to open position, troubleshoot Foam Not Delivered When Tank A is Selected (Bumper Turret, Ground Sweeps, and Manual Metering Controls) (WP 0095).

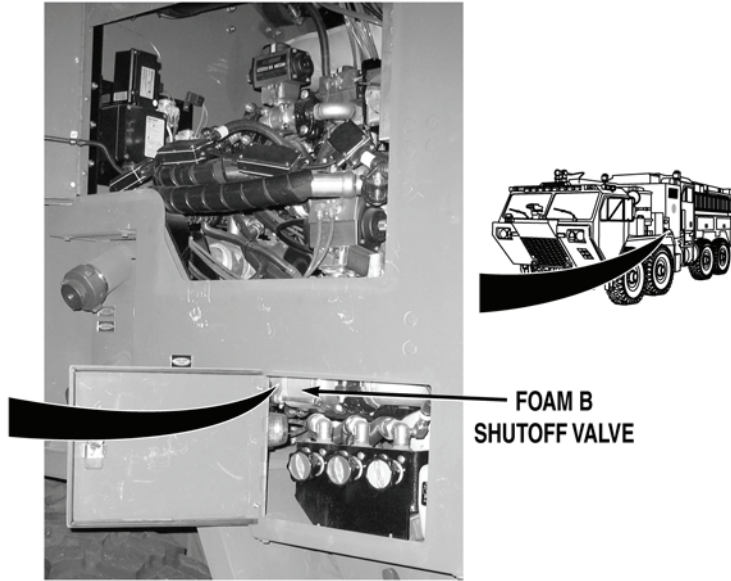
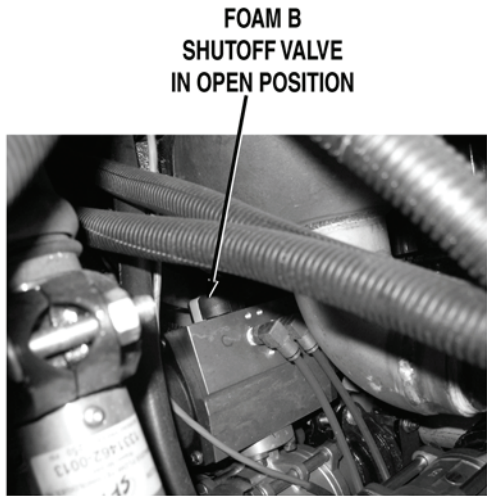
**MALFUNCTION****TEST OR INSPECTION****CORRECTIVE ACTION**

- Step 3. Put cab or pump operator's panel FOAM TANK switch to "B" position (WP 0004). While an assistant puts cab or pump operator's panel FOAM SYSTEM switch to on position (WP 0004), check if foam B system shutoff valve operates to open position.

If foam B system shutoff valve does not operate to open position, troubleshoot Foam Not Delivered When Tank B is Selected (Bumper Turret, Under Truck Nozzles, and Manual Metering Controls) (WP 0096).

---

**MALFUNCTION****TEST OR INSPECTION****CORRECTIVE ACTION**

---

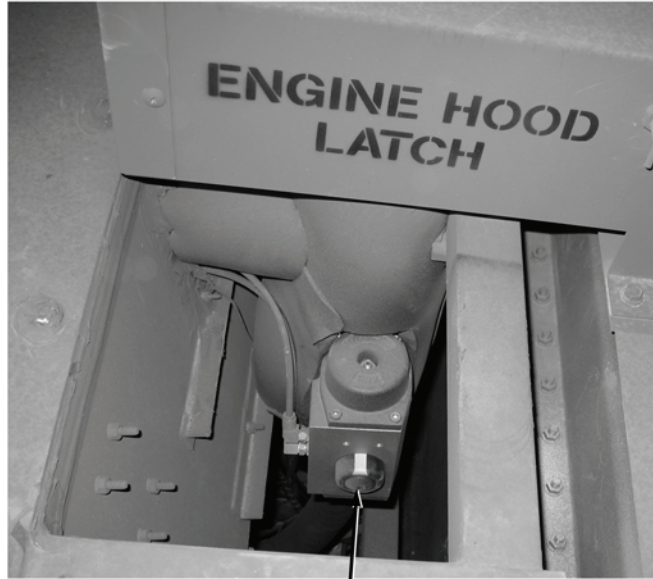

**BUMPER TURRET VALVE  
IN OPEN POSITION**

- Step 4. Put FOAM SYSTEM switch to OFF position (WP 0004). Put bumper turret POWER switch to I (on) position (WP 0004). While an assistant pushes bumper turret control agent discharge button (WP 0004), check if bumper turret valve operates to open position.

If bumper turret valve does not operate to open position, troubleshoot Bumper Turret Does Not Operate Properly When Selected (WP 0104).

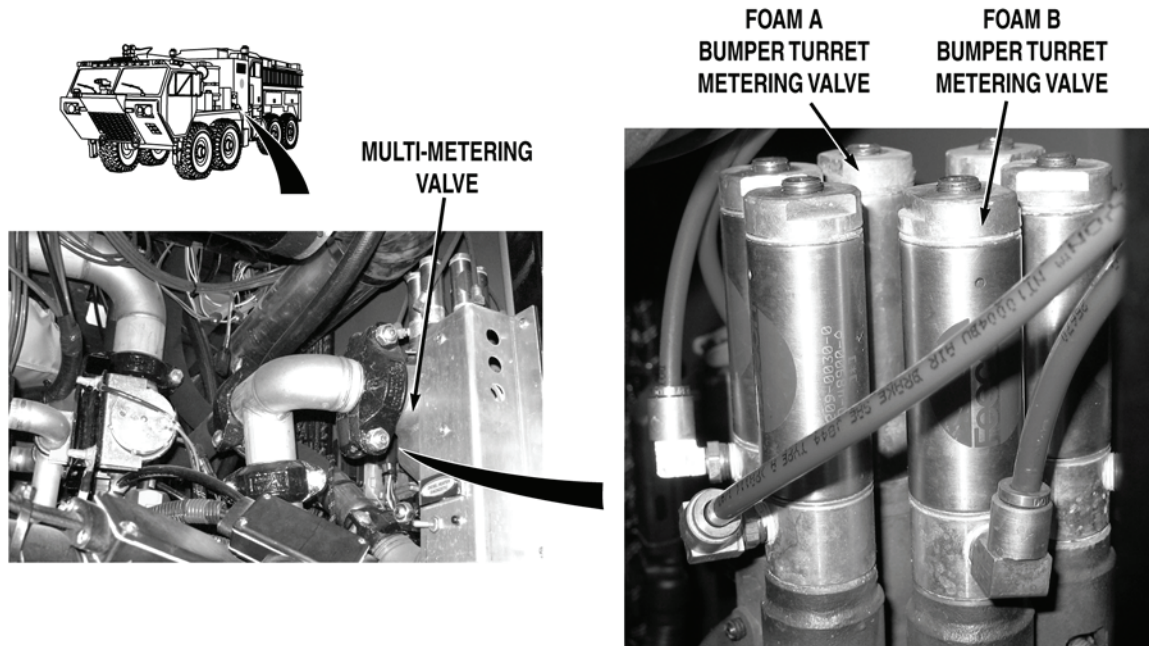
**MALFUNCTION****TEST OR INSPECTION****CORRECTIVE ACTION****NOTE**

Multi-metering valve operations can be checked by listening for metallic click during cylinder operation or observing piston tab.

- Step 5. Put cab or pump operator's panel FOAM SYSTEM switch to ON position (WP 0004). Put FOAM TANK switch to "A" position (WP 0004). While an assistant pushes bumper turret control foam agent button (WP 0004). Check if bumper turret foam A multi-metering valve cylinder operates to open position.

If bumper turret foam A multi-metering valve cylinder does not operate to open position go to Step 13.

- Step 6. Put cab or pump operator's panel FOAM SYSTEM switch to on position (WP 0004). Put FOAM TANK switch to "B" position (WP 0004). While an assistant pushes bumper turret control foam agent button (WP 0004). Check if bumper turret foam B multi-metering valve cylinder operates to open position.

If bumper turret foam B multi-metering valve cylinder does not operate to open position go to Step 8.

---

**MALFUNCTION****TEST OR INSPECTION****CORRECTIVE ACTION**

---

 **CAUTION**

- **Do not mix different types or brands of foam agent in foam cells or piping. Mixing of different foam agents (either type or manufacturer) may cause deterioration of foam agent, improper proportioning and poor performance in a fire situation. Mixing of Class A and Class B foam agents may result in a chemical reaction which can create globules, which can clog orifices and cause system failure.**
- **Failure to flush system after each foam use could result in equipment damage.**

**NOTE**

Do not open foam agent supply tanks while performing flush procedures.

- Step 7. Start water pump engine (WP 0022). Put pump operator's panel FOAM FLUSH switch to on position (WP 0004). Flush foam system (WP 0031). Put pump operator's panel FOAM FLUSH switch to off position (WP 0004). Put cab FOAM SYSTEM switch to on position (WP 0004). Put FOAM SELECT switch to "A" position (WP 0004). Put bumper turret POWER switch to | (on) position (WP 0004). Push bumper turret control foam agent button (WP 0004). Flush foam system (WP 0031). Retest system with foam B selected. Check if foam A and Foam B is delivered from bumper turret.
- a. If foam is delivered from bumper turret, fault corrected.
  - b. If foam is not delivered from bumper turret, replace foam system multi-metering valve (WP 0292).

**MALFUNCTION**

**TEST OR INSPECTION**

**CORRECTIVE ACTION**

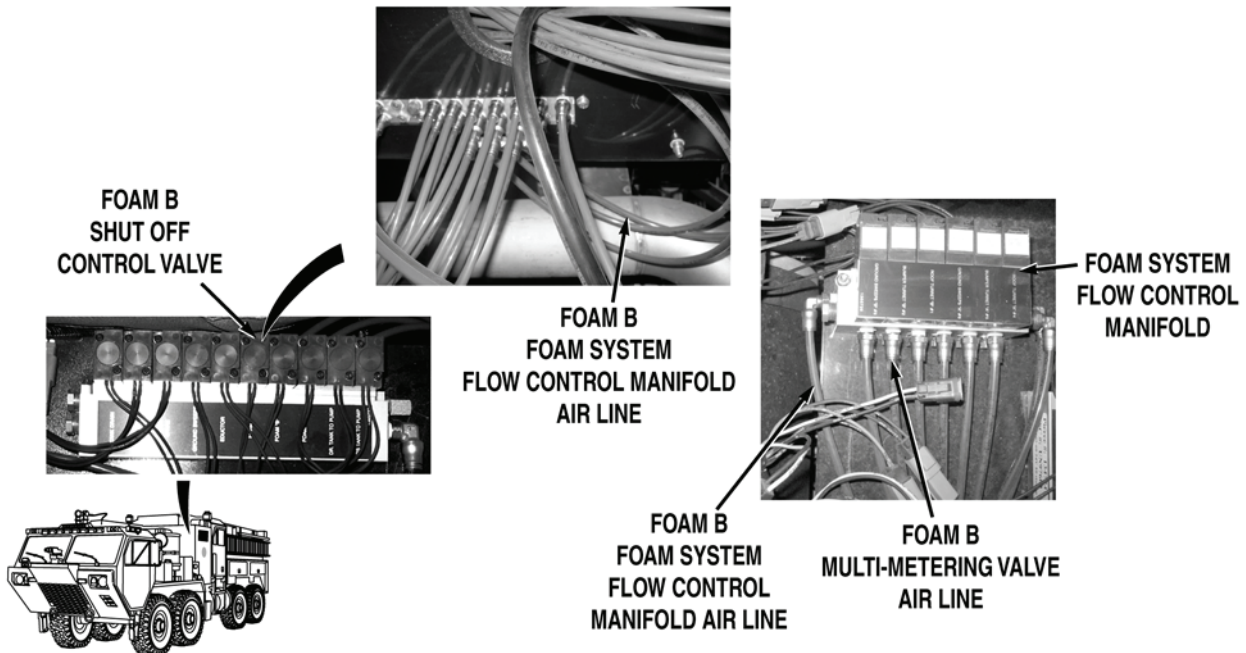

Step 8. Remove pump house panel S (WP 0540). Push and release bumper turret control foam agent button (WP 0004). Check air lines from foam B shutoff valve control manifold to foam system flow control manifold for leaks, kinks, or damage.

If air lines are not free from leaks, kinks, or damage replace damaged air lines (WP 0567).

Step 9. Check air lines from bumper turret foam B foam system flow control manifold to bumper turret foam B multi-metering valve cylinder for leaks, kinks, or damage.

If air lines are not free from leaks, kinks, or damage, replace damaged air lines (WP 0567).

---

**MALFUNCTION**  
**TEST OR INSPECTION**  
**CORRECTIVE ACTION**

---

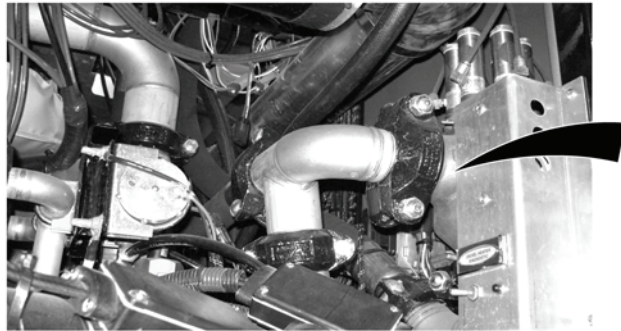

**BUMPER  
TURRET VALVE  
FOAM B  
MULTI-METERING  
VALVE CYLINDER**

**AIR LINE AT  
BUMPER TURRET  
FOAM B  
MULTI-METERING  
VALVE CYLINDER**

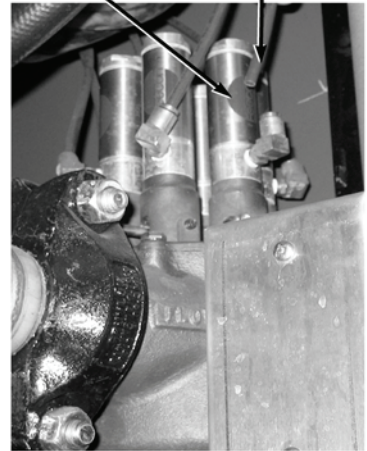

**WARNING**



- If air lines are under pressure when they are disconnected, they can whip around and cause injury to personnel. Caution should be exercised when disconnecting air line fittings.
- Air lines may be under pressure when control valve is operated. If under pressure and air lines are disconnected, air lines may whip around and cause injury to personnel. Caution should be exercised when operating control valve with air lines disconnected.

Step 10. Disconnect air line at bumper turret foam B multi-metering valve cylinder. While an assistant pushes bumper turret control agent discharge button (WP 0004), check if air pressure is present at bumper turret foam B multi-metering valve cylinder.

If there is air pressure, replace foam system multi-metering valve (WP 0292).

**MALFUNCTION**

**TEST OR INSPECTION**

**CORRECTIVE ACTION**

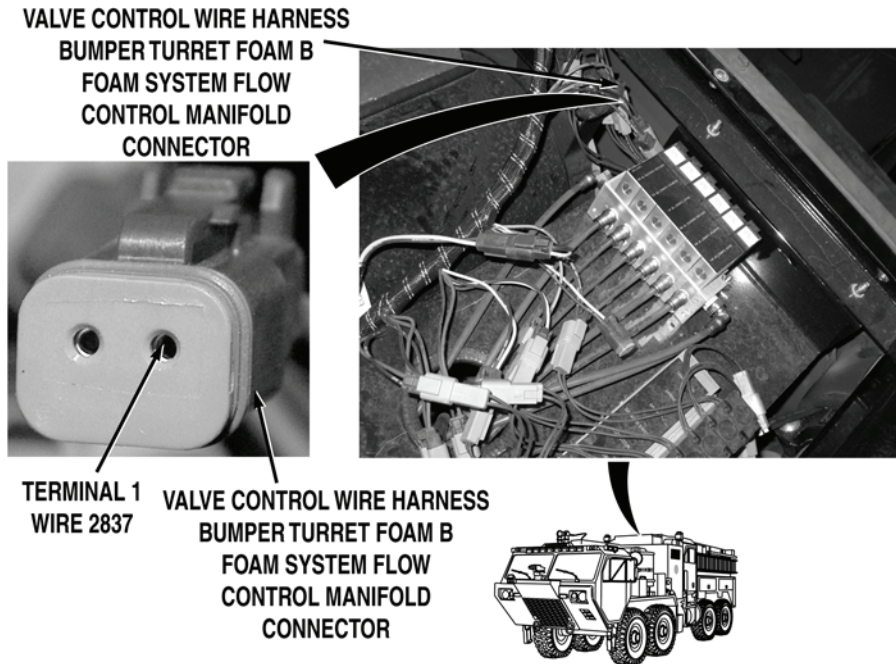

Step 11. Release bumper turret control agent discharge button (WP 0004). Reconnect air line at bumper turret foam B multi-metering valve cylinder. Disconnect valve control wire harness bumper turret foam B foam system flow control manifold connector. While an assistant pushes bumper turret discharge button (WP 0004). With a test lead set, check for 22 to 28 VDC between valve control wire harness wire 2837 (gray) at bumper turret foam B foam system flow control manifold connector, terminal 1 and a known good ground.

If 22 to 28 VDC are not present, repair wire 2837 in valve control wire harness if repairable (TM 9-2320-325-14&P), or replace valve control wire harness (WP 0463).

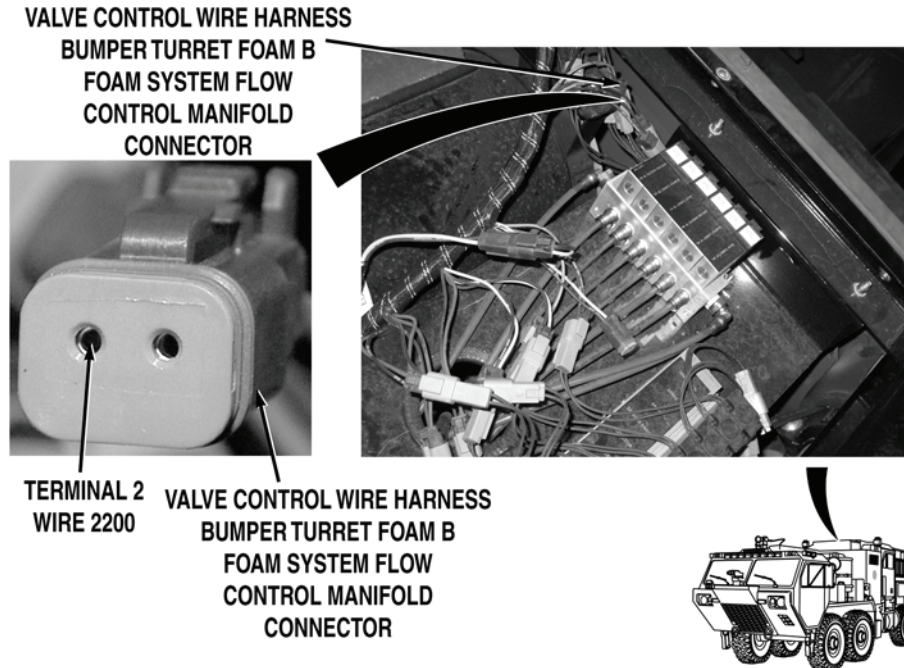

**MALFUNCTION****TEST OR INSPECTION****CORRECTIVE ACTION**

- Step 12. Put bumper turret power switch to  $\bigcirc$  (off) position (WP 0004). Turn battery disconnect switch to OFF position (WP 0004). With a test lead set, check for continuity across wire 2200 (black) from valve control wire harness bumper turret foam B foam system flow control manifold connector, terminal 2 to a known good ground.
- a. If there is continuity, replace bumper turret foam B metering control valve (WP 0288).
  - b. If there is no continuity, repair wire 2200 in valve control wire harness if repairable (TM 9-2320-325-14&P), or replace valve control wire harness (WP 0463).

**MALFUNCTION**

**TEST OR INSPECTION**

**CORRECTIVE ACTION**

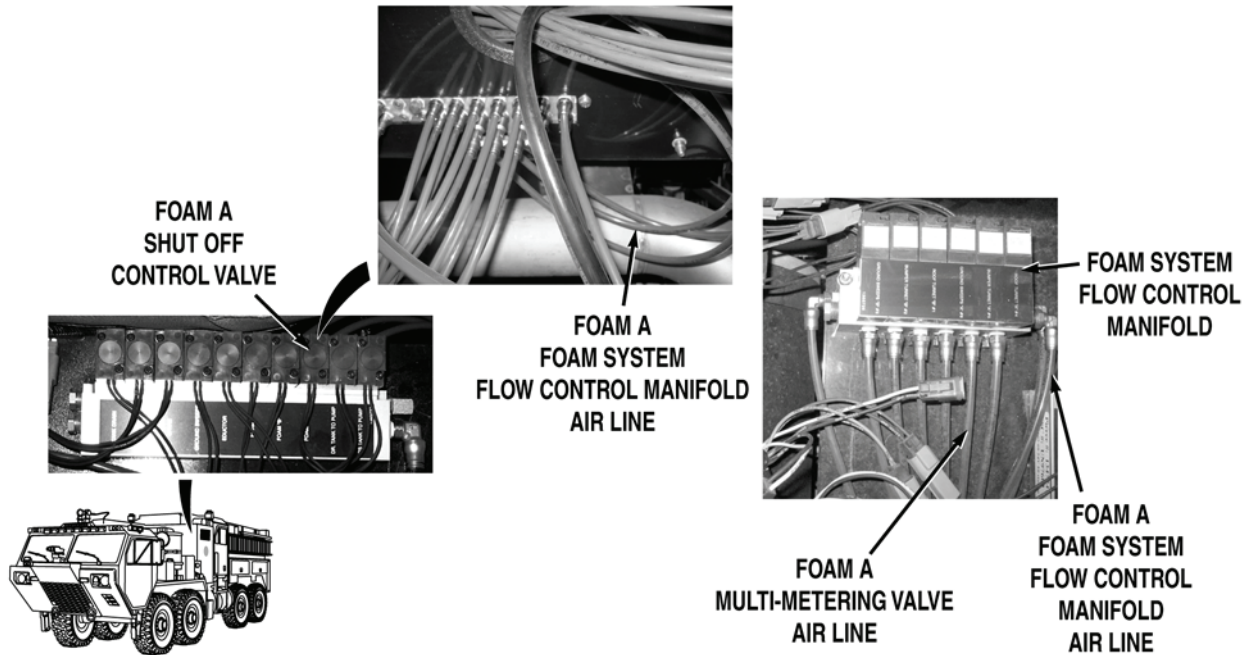

Step 13. Remove pump house panel S (WP 0540). Push and release bumper turret control foam agent button (WP 0004). Check air lines from foam A shutoff valve control manifold to foam system flow control manifold for leaks, kinks, or damage.

If air lines are not free from leaks, kinks, or damage, replace damaged air lines (WP 0567).

Step 14. Check air lines from bumper turret foam A foam system flow control manifold to bumper turret foam A multi-metering valve cylinder for leaks, kinks, or damage.

If air lines are not free from leaks, kinks, or damage, replace damaged air lines (WP 0567).

---

**MALFUNCTION**  
**TEST OR INSPECTION**  
**CORRECTIVE ACTION**

---

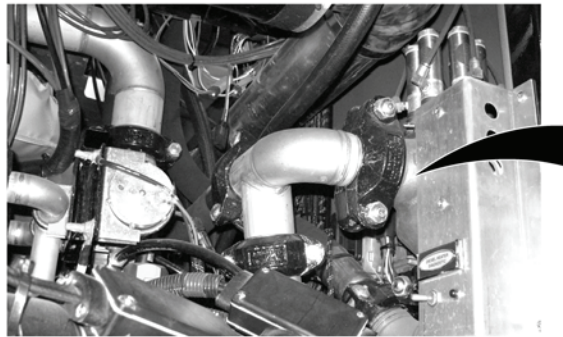

**AIR LINE AT BUMPER TURRET  
 FOAM A MULTI-METERING  
 VALVE CYLINDER**



**WARNING**



- If air lines are under pressure when they are disconnected, they can whip around and cause injury to personnel. Caution should be exercised when disconnecting air line fittings.
- Air lines may be under pressure when control valve is operated. If under pressure and air lines are disconnected, air lines may whip around and cause injury to personnel. Caution should be exercised when operating control valve with air lines.

Step 15. Disconnect air line at bumper turret foam A multi-metering valve cylinder. While an assistant pushes bumper turret control agent discharge button (WP 0004), check if air pressure is present at bumper turret foam A multi-metering valve cylinder.

If there is pressure, replace foam system multi-metering valve (WP 0292).

**MALFUNCTION**

**TEST OR INSPECTION**

**CORRECTIVE ACTION**

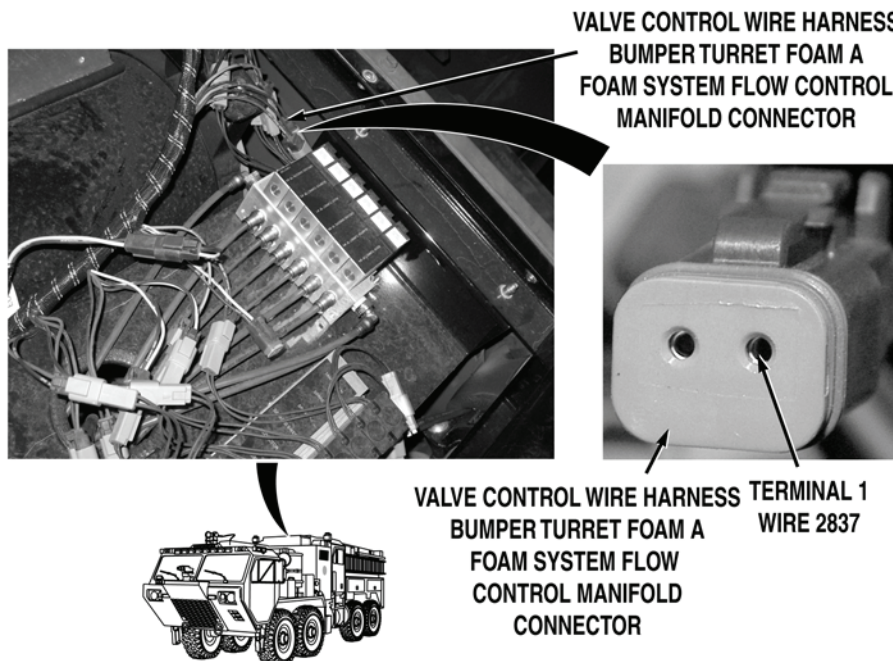

Step 16. Release bumper turret control agent discharge button (WP 0004). Reconnect air line at bumper turret foam A multi-metering valve cylinder. Disconnect valve control wire harness bumper turret foam A foam system flow control manifold connector. While an assistant pushes bumper turret discharge button (WP 0004). With a test lead set, check for 22 to 28 VDC between valve control wire harness wire 2837 (gray) at bumper turret foam A foam system flow control manifold, terminal 1, and a known good ground.

If 22 to 28 VDC are not present, repair wire 2837 in valve control wire harness if repairable (TM 9-2320-325-14&P), or replace valve control wire harness (WP 0463).

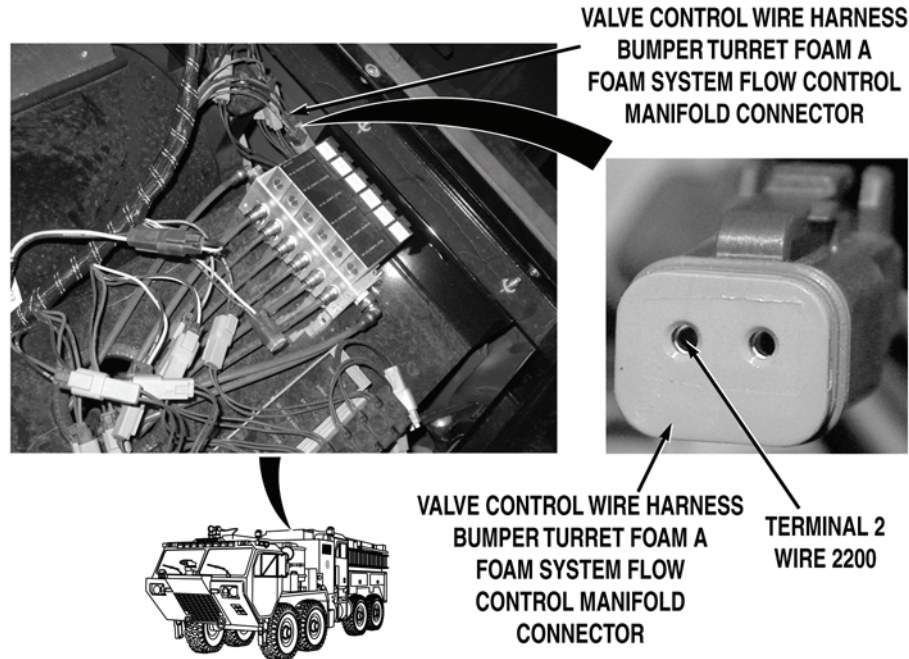
**MALFUNCTION****TEST OR INSPECTION****CORRECTIVE ACTION**

- Step 17. Put bumper turret power switch to  $\bigcirc$  (off) position (WP 0004). Turn battery disconnect switch to OFF position (WP 0004). With a test lead set, check for continuity across wire 2200 (black) from valve control wire harness bumper turret foam A foam system flow control manifold connector, terminal 2 to a known good ground.
- a. If there is continuity, replace bumper turret foam A metering control valve (WP 0288).
  - b. If there is no continuity, repair wire 2200 in valve control wire harness if repairable (TM 9-2320-325-14&P), or replace valve control wire harness (WP 0463).

**END OF TASK****FOLLOW-ON MAINTENANCE**

1. Install pump house panel S (WP 0540)
2. Remove wheel chocks (TM 9-2320-347-10)

**END OF TASK****END OF WORK PACKAGE**



**FIELD LEVEL MAINTENANCE**

**FOAM NOT DELIVERED FROM ROOF TURRET**

**INITIAL SETUP:**

**Tools and Special Tools**

- Lead Set, Test (WP 0622, Item 21)
- Tool Kit, General Mechanic's: Automotive (WP 0622, Item 27)

**Personnel Required**

- MOS 63B Wheeled vehicle mechanic (2)

**References**

- TM 9-2320-325-14&P
- WP 0004
- WP 0007
- WP 0022
- WP 0031
- WP 0094
- WP 0095
- WP 0096

**References (continued)**

- WP 0116
- WP 0288
- WP 0292
- WP 0463
- WP 0539
- WP 0540
- WP 0567

**Equipment Conditions**

- Water pump engine OFF (WP 0022)
- Engine OFF (TM 9-2320-347-10)
- Wheels chocked (TM 9-2320-347-10)

**MALFUNCTION**

**TEST OR INSPECTION**

**CORRECTIVE ACTION**

**FOAM NOT DELIVERED FROM ROOF TURRET**

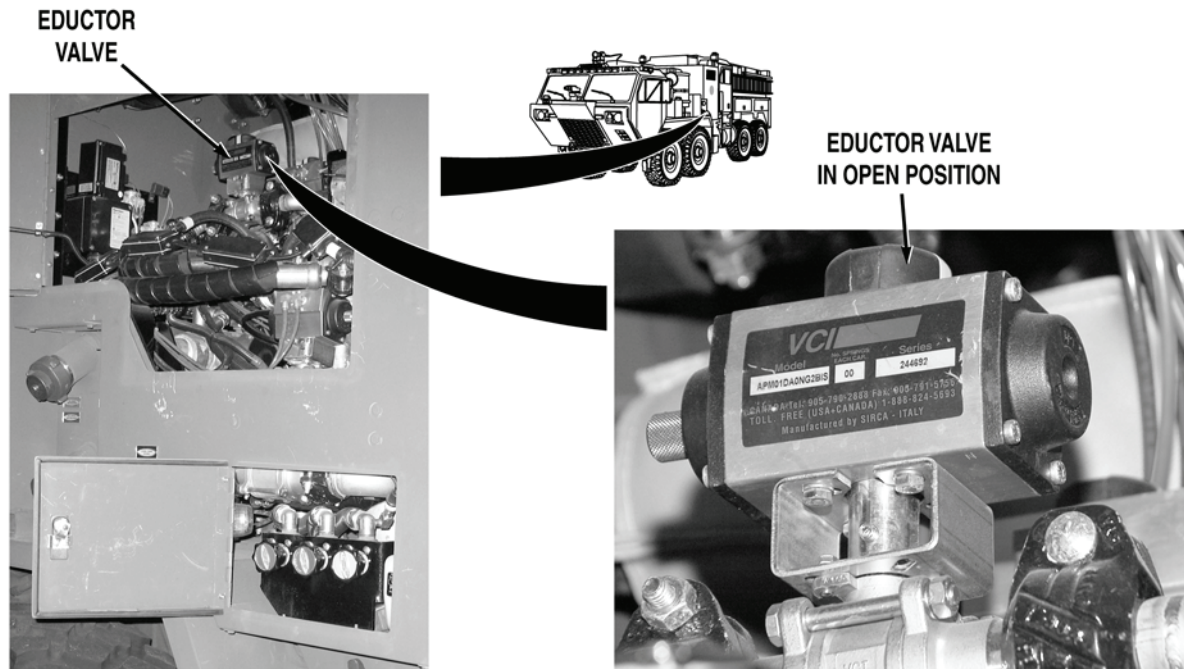
**MALFUNCTION****TEST OR INSPECTION****CORRECTIVE ACTION****NOTE**

- Ensure system air pressure is at least 85 psi (586 kPa) during this procedure. System air pressure is required to activate valves.
- Do not engage water pump engine during this procedure, except when performing complete system checks. Valve operations can be checked without water pump operation.
- Valve operations can be checked by observing valve shaft rotation. Valves are open when tabs or yellow paint tabs are aligned with direction of fluid flow.

Step 1. Turn battery disconnect switch to ON position (WP 0007). If system air pressure is below 85 psi (586 kPa), start engine and allow system air pressure to build to at least 85 psi (586 kPa) (TM 9-2320-347-10). Then shut off engine (TM 9-2320-347-10). Open pump house access door A (WP 0539). While an assistant puts pump operator's panel FOAM SYSTEM switch to on position (WP 0004), check if eductor valve operate to open position.

If eductor valve does not operate to open position, troubleshoot Foam Not Delivered From All Systems (Bumper Turret, Ground Sweeps, and Manual Metering Controls) or System Does Not Shut Off (WP 0094).

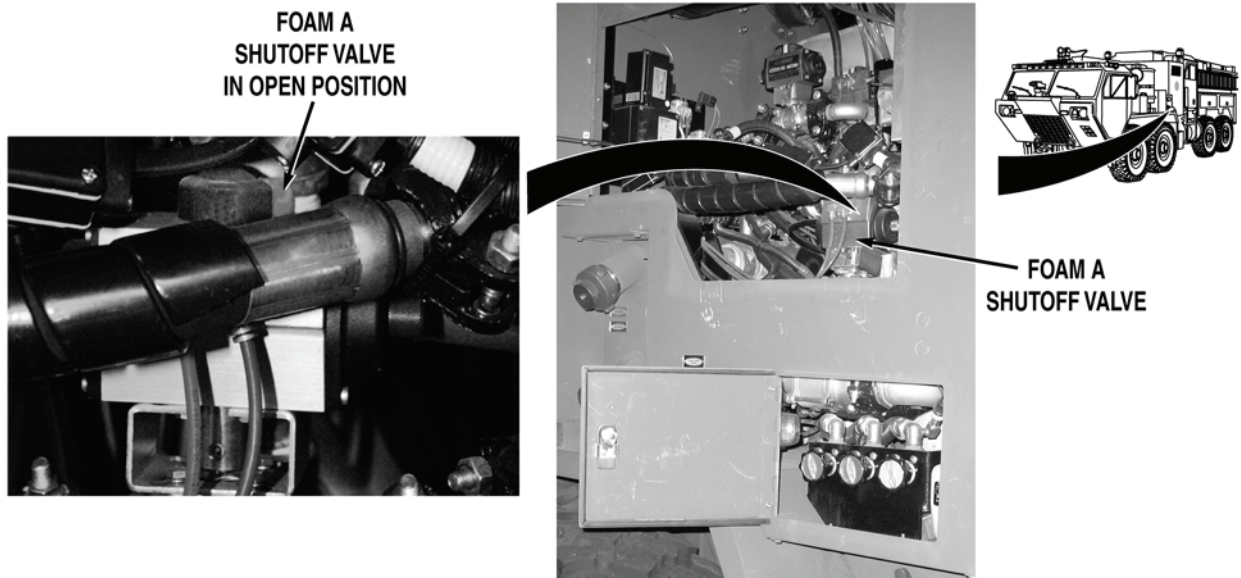

**MALFUNCTION****TEST OR INSPECTION****CORRECTIVE ACTION**

Step 2. While an assistant puts cab or pump operator's panel FOAM SYSTEM switch to ON position (WP 0004), check if foam system shutoff valve operates to OPEN position. Put cab or pump operator's panel FOAM TANK switch to "A" position (WP 0004).

If foam A system shutoff valve does not operate to OPEN position, troubleshoot Foam Not Delivered When Tank A is Selected (Bumper Turret, Ground Sweeps, and Manual Metering Controls) (WP 0095).

**MALFUNCTION**

**TEST OR INSPECTION**

**CORRECTIVE ACTION**

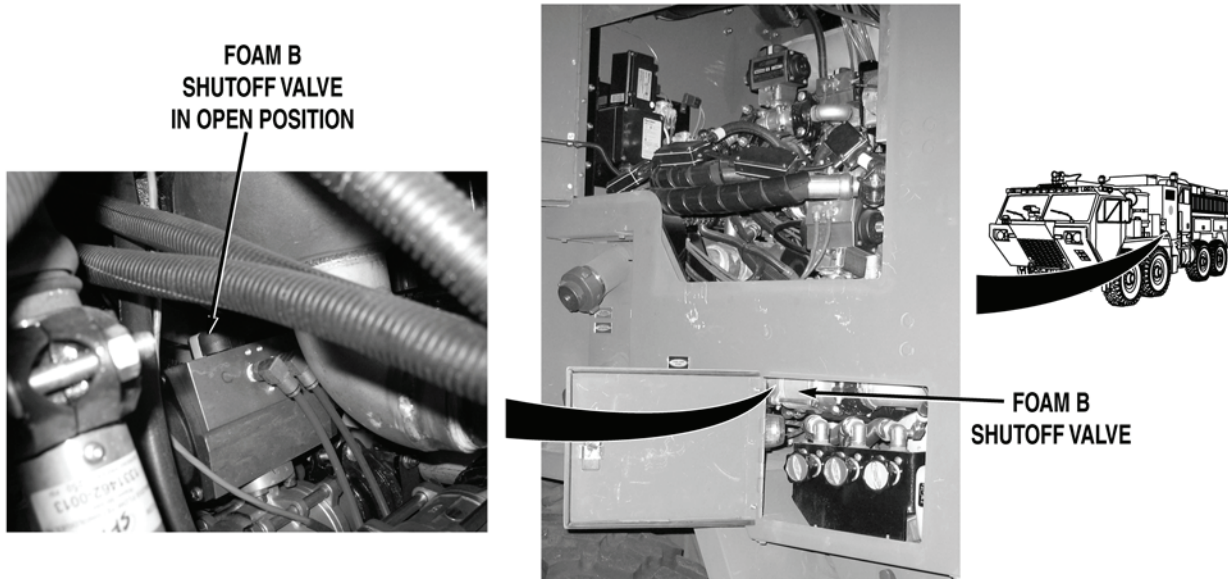

Step 3. While an assistant puts cab or pump operator's panel FOAM SYSTEM switch to ON position (WP 0004), check if foam system shutoff valve operate to OPEN position. Put cab or pump operator's panel FOAM TANK switch to "B" position (WP 0004).

If foam B system shutoff valve does not operator to OPEN position, troubleshoot Foam Not Delivered When Tank B is Selected (Bumper Turret, Under Truck Nozzles, and Manual Metering Controls) (WP 0096).

---

**MALFUNCTION****TEST OR INSPECTION****CORRECTIVE ACTION**

---

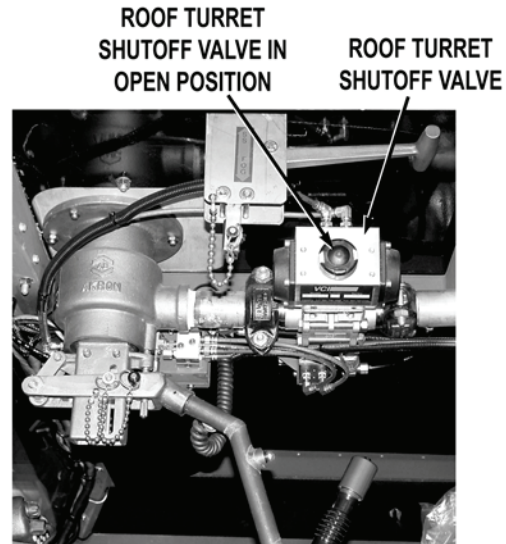

- Step 4. Put FOAM SYSTEM switch to OFF position (WP 0004). Push and release roof turret agent discharge button (WP 0004).

If roof turret valve does not operate to open position, troubleshoot Roof Turret Does Not Operate When Selected (WP 0116).

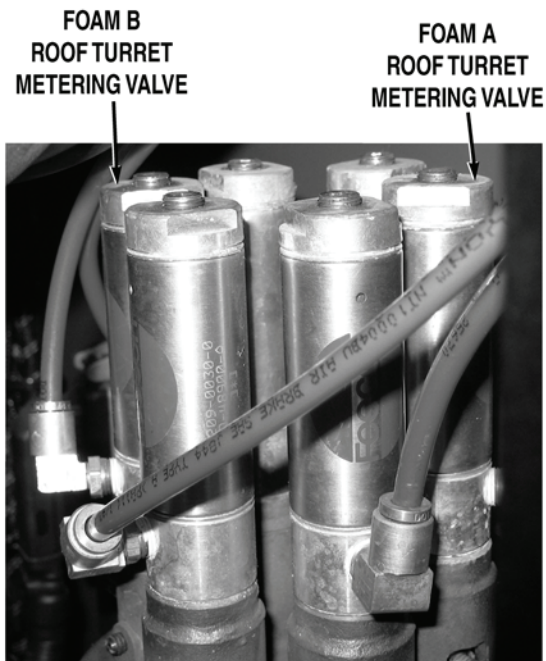
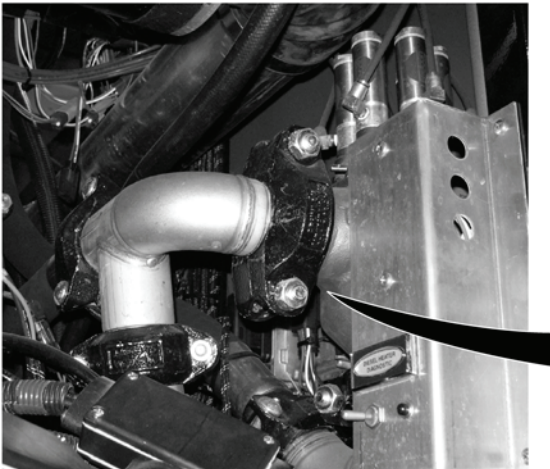
**MALFUNCTION****TEST OR INSPECTION****CORRECTIVE ACTION****NOTE**

Multi-metering valve operation can be checked by listening for metallic click during cylinder operation or by observing piston tab.

- Step 5. Put cab FOAM SYSTEM switch to ON position (WP 0004). Put FOAM TANK switch to "A" position (WP 0004). Check if roof turret foam A multi-metering valve cylinder operates to OPEN position.

If roof turret foam A multi-metering valve cylinder does not operate to open position go to Step 13.

- Step 6. While an assistant puts cab or pump operator's panel FOAM SYSTEM switch to ON position (WP 0004), put FOAM TANK switch to "B" position (WP 0004). Check if roof turret foam B multi-metering valve cylinder operates to OPEN position.

If roof turret foam B multi-metering valve cylinder does not operate to OPEN position, go to Step 8.

---

**MALFUNCTION****TEST OR INSPECTION****CORRECTIVE ACTION**

---

 **CAUTION**

- Do not mix different types or brands of foam agent in foam cells or piping. Mixing of different foam agents (either type or manufacturer) may cause deterioration of foam agent, improper proportioning and poor performance in a fire situation. Mixing of Class A and Class B foam agents may result in a chemical reaction which can create globules, which can clog orifices and cause system failure.
- Failure to flush foam system after each foam use could result in equipment damage.

**NOTE**

- Do not open foam agent supply tanks while performing flush procedures.
- Before flushing system, make sure that FOAM SYSTEM switch is in off position (WP 0004).

Step 7. Pump from onboard water tank (WP 0026). Put personnel cab FOAM SYSTEM switch to on position (WP 0004). Put personnel cab FOAM SELECT switch to A position (WP 0004). Push and release roof turret agent discharge button (WP 0004). Check if foam is delivered from roof turret in foam B. Flush foam system (WP 0031). Retest system with foam A selected. Check if foam is delivered from roof turret in foam A.

- a. If foam is delivered from roof turret, fault corrected.
- b. If foam is not delivered from roof turret, replace foam system multi-metering valve (WP 0292).

**MALFUNCTION**

**TEST OR INSPECTION**

**CORRECTIVE ACTION**

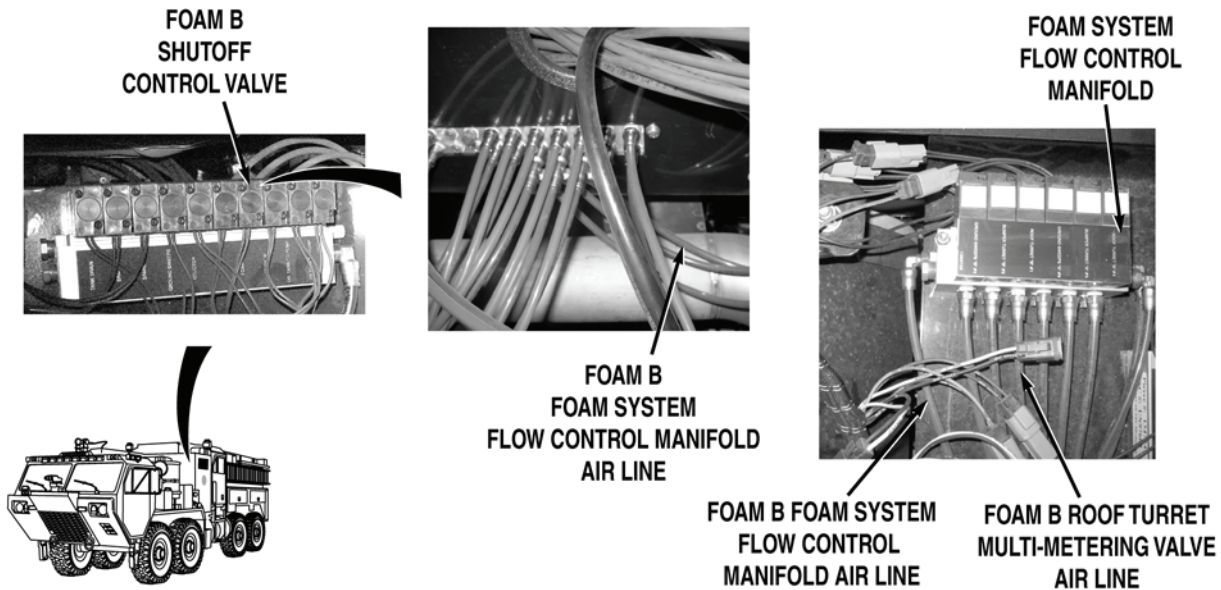

Step 8. Remove pump house panel S (WP 0540). Put cab FOAM SYSTEM switch to off position (WP 0004). Push and release roof turret agent discharge button (WP 0004). Check air lines from FOAM B shutoff valve control manifold to foam system flow control manifold for leaks, kinks, or damage.

If air lines are not free from leaks, kinks, or damage, replace damaged lines (WP 0567).

Step 9. Check lines from ROOF TURRET FOAM B foam system flow control manifold to roof turret foam B multi-metering valve cylinder for leaks, kinks, or damage.

If air lines are not free from leaks, kinks, or damage, replace damaged lines (WP 0567).

**MALFUNCTION****TEST OR INSPECTION****CORRECTIVE ACTION**

ROOF TURRET FOAM B  
MULTI-METERING  
VALVE CYLINDER

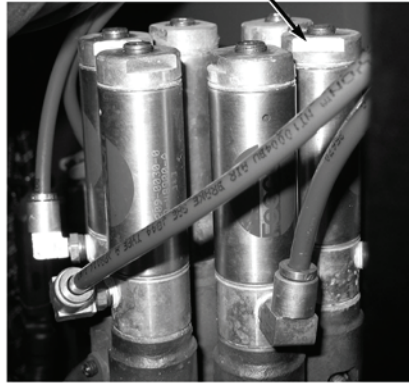

AIR LINE AT ROOF TURRET  
FOAM B MULTI-METERING  
VALVE CYLINDER

**WARNING**

- If air lines are under pressure when they are disconnected, they can whip around and cause injury to personnel. Caution should be exercised when disconnecting air line fittings.
- Air lines may be under pressure when control valve is operated. If under pressure and air lines are disconnected, air lines may whip around and cause injury to personnel. Caution should be exercised when operating control valve with air lines disconnected.

Step 10. Disconnect air line at roof turret foam B multi-metering valve cylinder. While an assistant pushes roof turret agent discharge button (WP 0004). Put cab FOAM SYSTEM switch to on position (WP 0004). Put cab FOAM SELECT switch to B position (WP 0004), check if air pressure is present at ground sweeps foam B multi-metering valve cylinder.

If there is air pressure, replace foam system multi-metering valve (WP 0292).

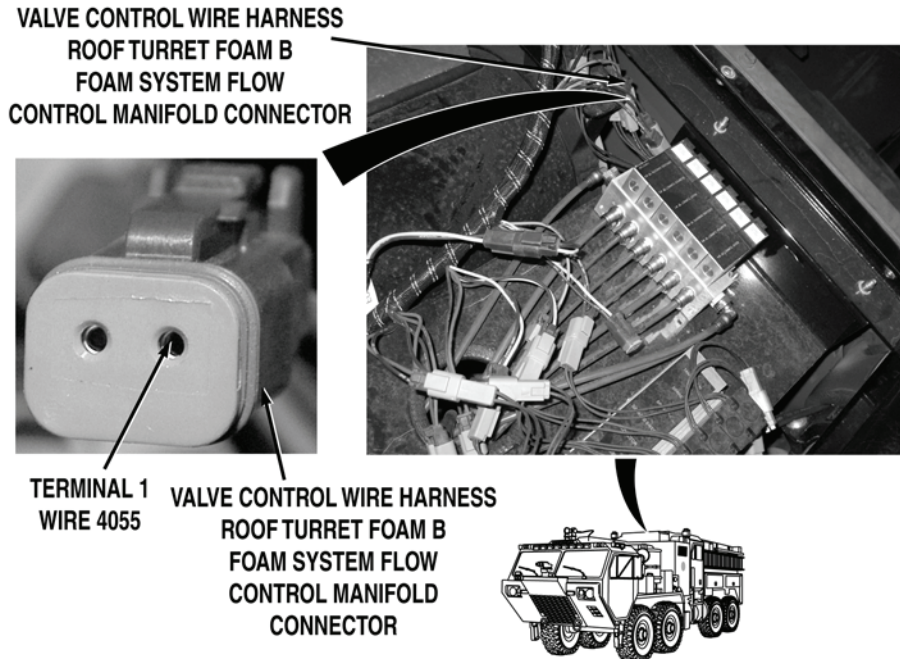
**MALFUNCTION****TEST OR INSPECTION****CORRECTIVE ACTION**

- Step 11. Put cab FOAM SYSTEM switch to off position (WP 0004). Reconnect air line at roof turret foam B multi-metering valve cylinder. Disconnect pump house wire harness ROOF TURRET FOAM B foam system flow control manifold connector. Put cab FOAM SYSTEM switch to on position (WP 0004). Put cab FOAM SELECT switch to B position (WP 0004). With a test lead set, check for 22 to 28 VDC between valve control wire harness wire 4055 (purple) at roof turret foam B foam system flow control manifold connector, terminal 1, and a known good ground.

If 22 to 28 VDC are not present, repair wire 4055 (purple) in pump house wire harness if repairable (TM 9-2320-325-14&P), or replace valve control wire harness (WP 0463).

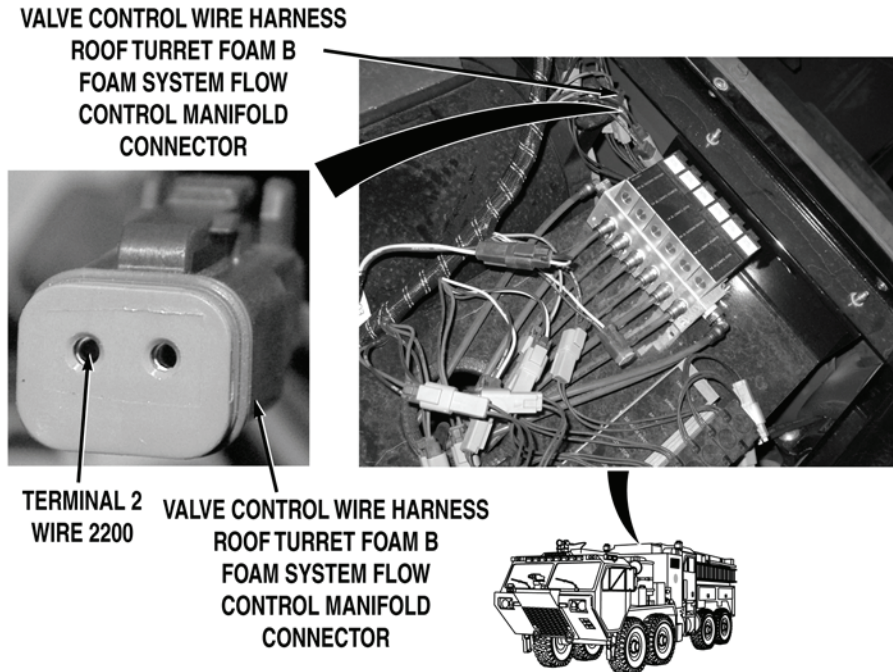

**MALFUNCTION****TEST OR INSPECTION****CORRECTIVE ACTION**

- Step 12. Push and release roof turret agent discharge button (WP 0004). Turn battery disconnect switch to OFF position (WP 0004). With a test lead set, check for continuity across wire 2200 (black) from valve control wire harness roof turret foam B foam system flow control manifold connector, terminal 2 to a known good ground.
- a. If there is continuity, replace ROOF TURRET FOAM B metering control valve (WP 0288).
  - b. If there is no continuity, repair wire 2200 in valve control wire harness if repairable (TM 9-2320-325-14&P), or replace valve control wire harness (WP 0463).

**MALFUNCTION**

**TEST OR INSPECTION**

**CORRECTIVE ACTION**

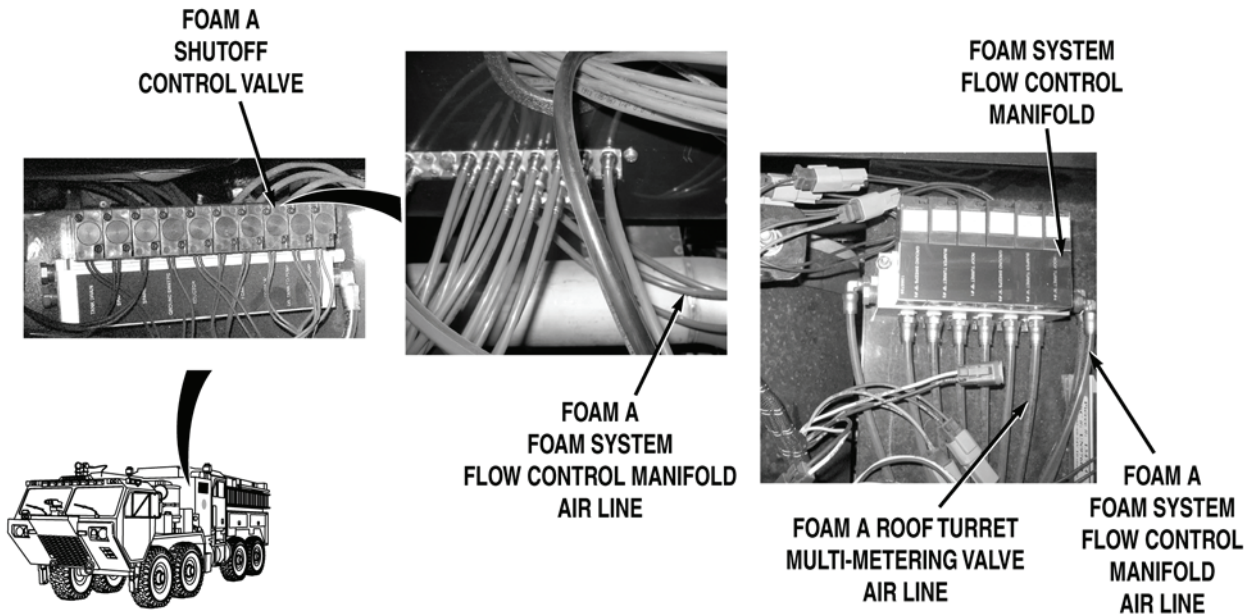

Step 13. Remove pump house panel S (WP 0540). Put cab FOAM SYSTEM switch to off position (WP 0004). Push and release roof turret agent discharge button (WP 0004). Check air lines from FOAM A shutoff valve control manifold to foam system flow control manifold for leaks, kinks, or damage.

If air lines are not free from leaks, kinks, or damage, replace damaged air lines (WP 0567).

Step 14. Check lines from ROOF TURRET FOAM A foam system flow control manifold to roof turret foam A multi-metering valve cylinder for leaks, kinks, or damage.

If air lines are not free from leaks, kinks, or damage, replace damaged air lines (WP 0567).

---

<b>MALFUNCTION</b>	
<b>TEST OR INSPECTION</b>	
<b>CORRECTIVE ACTION</b>	

---

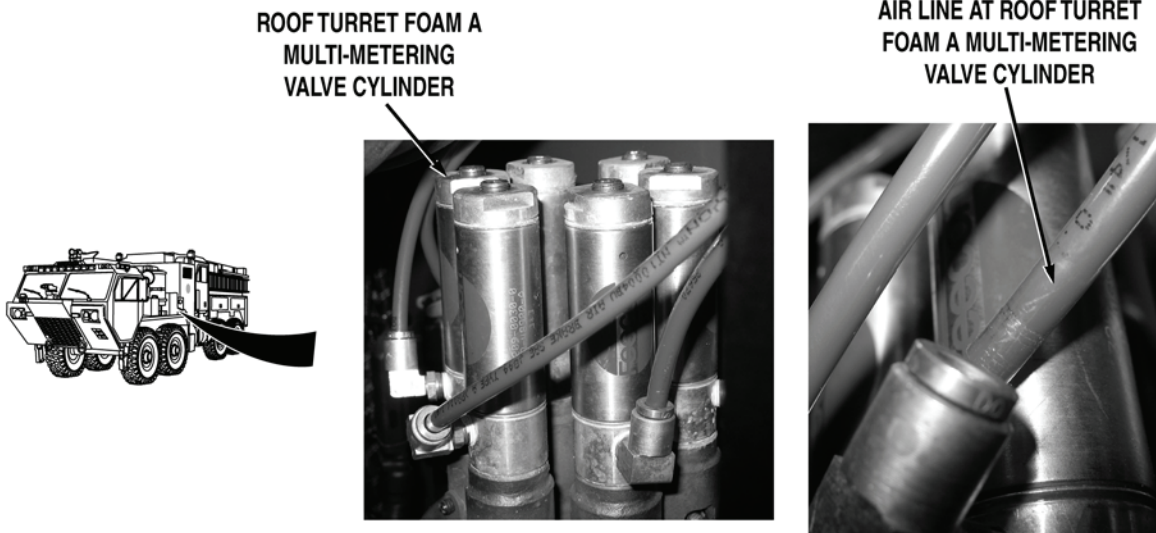
**WARNING**

- If air lines are under pressure when they are disconnected, they can whip around and cause injury to personnel. Caution should be exercised when disconnecting air line fittings.
- Air lines may be under pressure when control valve is operated. If under pressure and air lines are disconnected, air lines may whip around and cause injury to personnel. Caution should be exercised when operating control valve with air lines disconnected.

Step 15. Disconnect air line at roof turret foam A multi-metering valve cylinder. While an assistant pushes and releases roof turret agent discharge button (WP 0004). Put cab FOAM SYSTEM switch to on position (WP 0004). Put cab FOAM SELECT switch to A position (WP 0004), check if air pressure is present at roof turret foam A multi-metering valve cylinder.

If there is air pressure, replace foam system multi-metering valve (WP 0292).

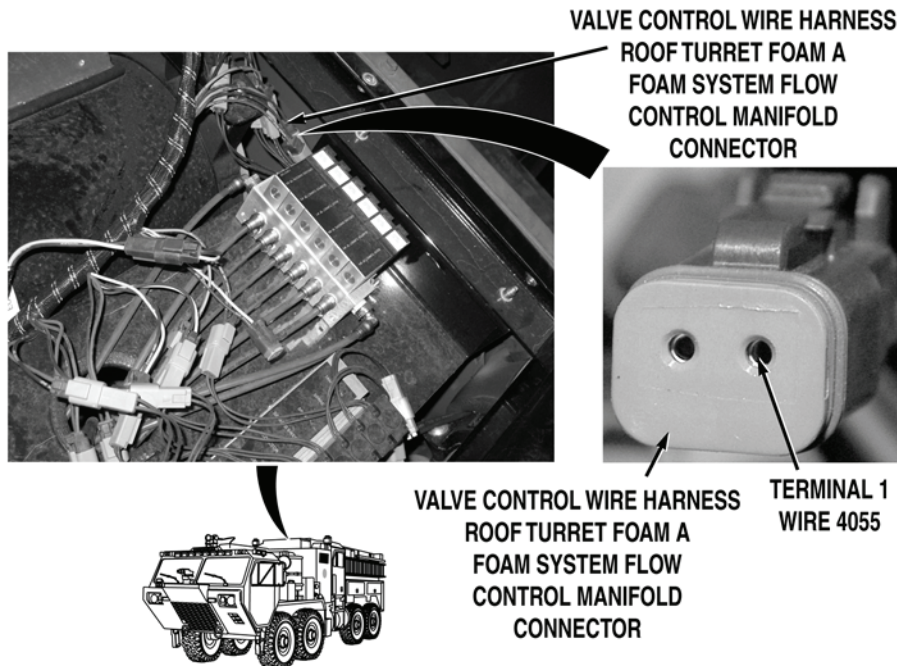
**MALFUNCTION****TEST OR INSPECTION****CORRECTIVE ACTION**

- Step 16. Put cab FOAM SYSTEM switch to off position (WP 0004). Reconnect air line at roof turret foam A multi-metering valve cylinder. Disconnect valve control wire harness roof turret foam A multi-metering connector. Put cab FOAM SYSTEM switch to on position (WP 0004). Put cab FOAM SELECT switch to A position (WP 0004). With a test lead set, check for 22 to 28 VDC between valve control wire harness wire 4055 (purple) at ROOF TURRET FOAM A foam system flow control manifold connector, terminal 1, and a known good ground.

If 22 to 28 VDC are not present, repair wire 4055 (purple) in valve control wire harness if repairable (TM 9-2320-325-14&P), or replace valve control wire harness (WP 0463).

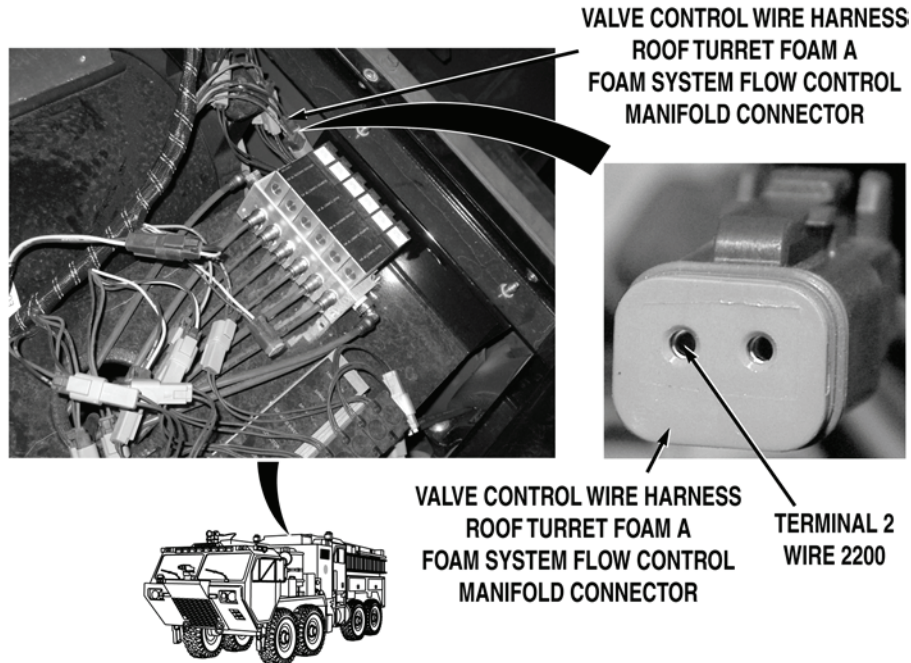
**MALFUNCTION****TEST OR INSPECTION****CORRECTIVE ACTION**

- Step 17. Put ROOF TURRET switch to off position (WP 0004). Turn battery disconnect switch to OFF position (WP 0004). With a test lead set, check for continuity across wire 2200 (black) from valve control wire harness ROOF TURRET FOAM A foam system flow control manifold connector, terminal 2 to a known good ground.
- a. If there is continuity, replace ROOF TURRET FOAM A metering control valve (WP 0288).
  - b. If there is no continuity, repair wire 2200 in valve control wire harness if repairable (TM 9-2320-325-14&P), or replace valve control wire harness (WP 0463).

**END OF TASK****FOLLOW-ON MAINTENANCE**

Remove wheel chocks (TM 9-2320-347-10)

**END OF TASK****END OF WORK PACKAGE**



**FIELD LEVEL MAINTENANCE**

**FOAM NOT DELIVERED FROM GROUND SWEEPS**

**INITIAL SETUP:**

**Tools and Special Tools**

Lead Set, Test (WP 0622, Item 21)  
 Tool Kit, General Mechanic's: Automotive  
 (WP 0622, Item 27)

**Personnel Required**

MOS 63B Wheeled vehicle mechanic (2)

**References**

TM 9-2320-325-14&P  
 WP 0004  
 WP 0007  
 WP 0022  
 WP 0031  
 WP 0094

**References (continued)**

WP 0095  
 WP 0096  
 WP 0120  
 WP 0288  
 WP 0292  
 WP 0463  
 WP 0539  
 WP 0540  
 WP 0567

**Equipment Conditions**

Water pump engine OFF (WP 0022)  
 Engine OFF (TM 9-2320-347-10)  
 Wheels chocked (TM 9-2320-347-10)

**MALFUNCTION**

**TEST OR INSPECTION**

**CORRECTIVE ACTION**

**FOAM NOT DELIVERED FROM GROUND SWEEPS**

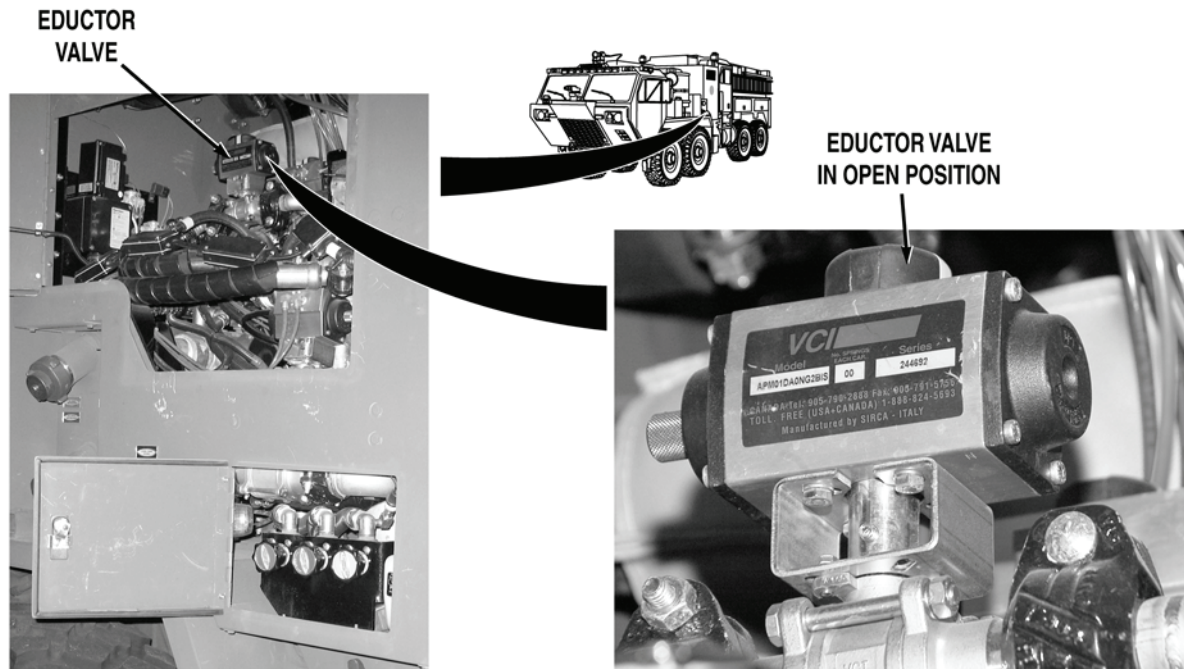
**MALFUNCTION****TEST OR INSPECTION****CORRECTIVE ACTION****NOTE**

- Ensure system air pressure is at least 85 psi (586 kPa) during this procedure. System air pressure is required to activate valves.
- Do not engage water pump engine during this procedure, except when performing complete system checks. Valve operations can be checked without water pump operation.
- Valve operations can be checked by observing valve shaft rotation. Valves are open when tabs or yellow paint tabs are aligned with direction of fluid flow.

Step 1. Turn battery disconnect switch to ON position (WP 0007). If system air pressure is below 85 psi (586 kPa), start engine and allow system air pressure to build to at least 85 psi (586 kPa) (TM 9-2320-347-10). Then shut off engine (TM 9-2320-347-10). Open pump house access door A (WP 0539). While an assistant puts pump operator's panel FOAM SYSTEM switch to on position (WP 0004), check if eductor valve operates to open position.

If eductor valve does not operate to open position, troubleshoot Foam Not Delivered From All Systems (Bumper Turret, Ground Sweeps, and Manual Metering Controls) or System Does Not Shut Off (WP 0094).

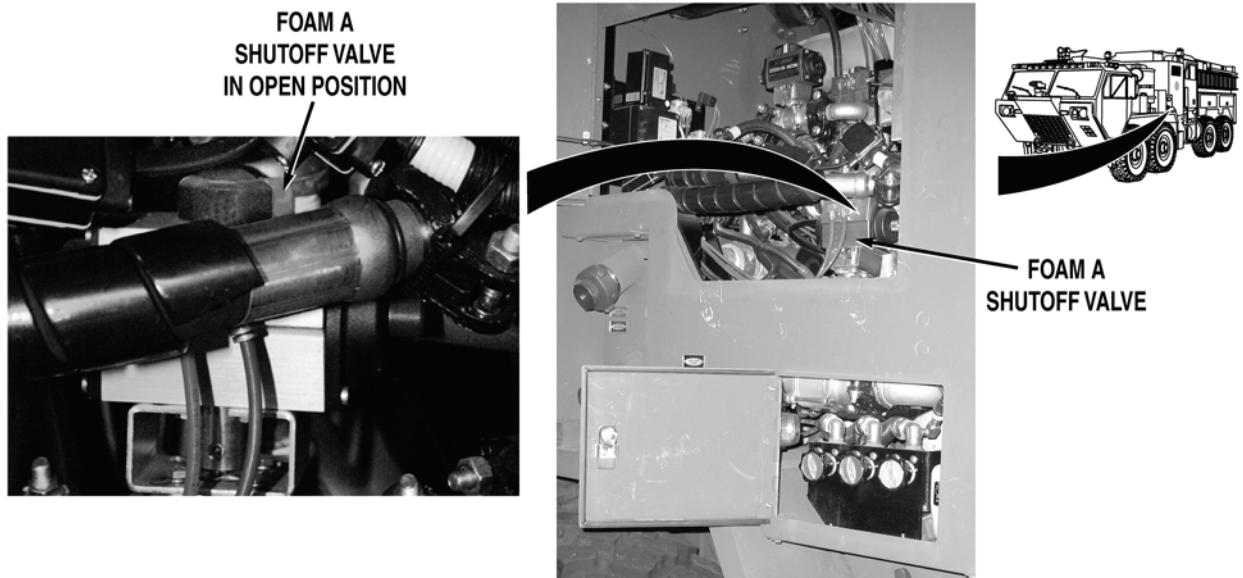

**MALFUNCTION****TEST OR INSPECTION****CORRECTIVE ACTION**

- Step 2. Put cab or pump operator's panel FOAM TANK switch to "A" position (WP 0004). While an assistant puts cab or pump operator's panel FOAM SYSTEM switch to on position (WP 0004), check if foam system shutoff valve operates to open position.

If foam A system shutoff valve does not operate to open position, troubleshoot Foam Not Delivered When Tank A is Selected (Bumper Turret, Ground Sweeps, and Manual Metering Controls) (WP 0095).

**MALFUNCTION**

**TEST OR INSPECTION**

**CORRECTIVE ACTION**

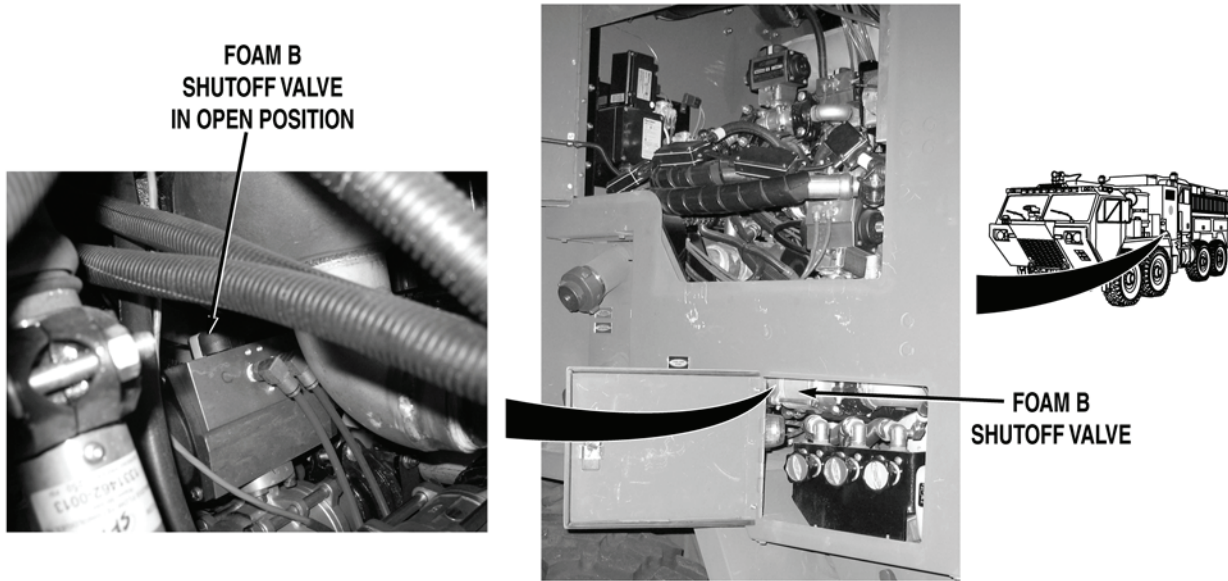

Step 3. While an assistant puts cab or pump operator's panel FOAM SYSTEM switch to on position (WP 0004). Put cab or pump operator's panel FOAM TANK switch to "B" position (WP 0004), check if foam system shutoff valve operates to open position.

If foam B system shutoff valve does not operator to open position, troubleshoot Foam Not Delivered When Tank B is Selected (Bumper Turret, Under Truck Nozzles, and Manual Metering Controls) (WP 0096).

---

**MALFUNCTION**  
**TEST OR INSPECTION**  
**CORRECTIVE ACTION**

---

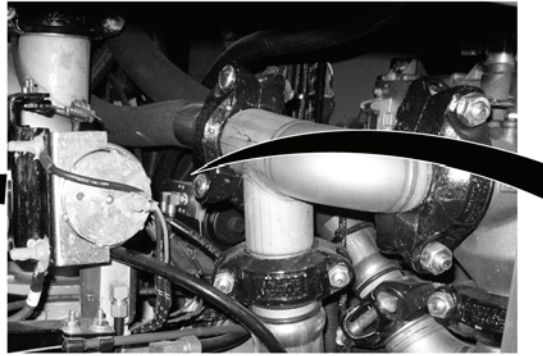

- Step 4. Put FOAM SYSTEM switch to OFF position (WP 0004). While an assistant puts GROUND SWEEPS switch to on position (WP 0004). Check if ground sweeps valve operates to open position.

If ground sweeps valve does not operate to open position, troubleshoot Ground Sweeps Do Not Operate When Selected (WP 0120).

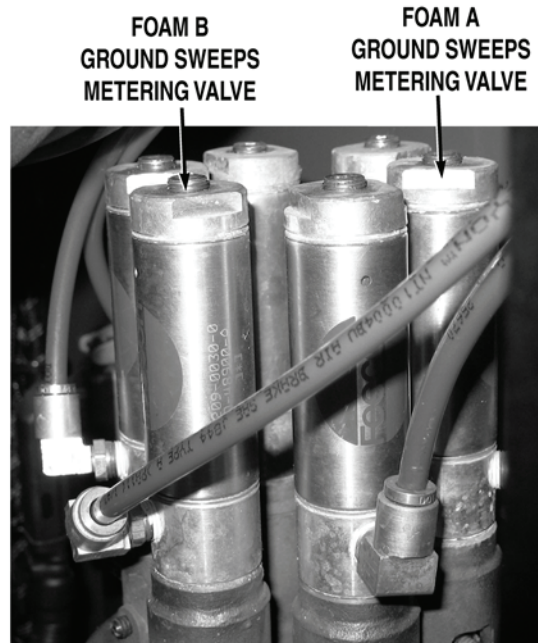
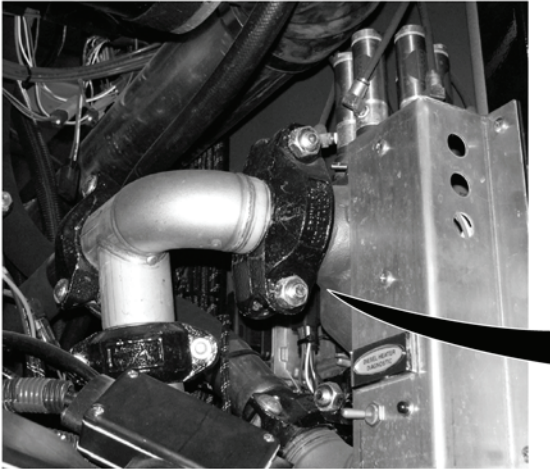
**MALFUNCTION****TEST OR INSPECTION****CORRECTIVE ACTION****NOTE**

Multi-metering valve operation can be checked by listening for metallic click during cylinder operation or by observing piston tab.

- Step 5. Put cab FOAM SYSTEM switch to ON position (WP 0004). Put cab FOAM SELECT switch to A position (WP 0004). Check if ground sweeps foam A multi-metering valve cylinder operates to open position.

If ground sweeps foam A multi-metering valve cylinder does not operate to open position go to Step 13.

- Step 6. Flush foam system (WP 0031). While an assistant puts cab or pump operator's panel FOAM SYSTEM switch to on position (WP 0004), check if ground sweeps foam B multi-metering valve cylinder operates to open position. Put pump operator's panel FOAM TANK switch to "B" position (WP 0004).

If ground sweeps foam B multi-metering valve cylinder does not operate to open position, go to Step 8.

---

**MALFUNCTION****TEST OR INSPECTION****CORRECTIVE ACTION**

---

 **CAUTION**

- Do not mix different types or brands of foam agent in foam cells or piping. Mixing of different foam agents (either type or manufacturer) may cause deterioration of foam agent, improper proportioning and poor performance in a fire situation. Mixing of Class A and Class B foam agents may result in a chemical reaction which can create globules, which can clog orifices and cause system failure.
- Failure to flush foam system after each foam use could result in equipment damage.

**NOTE**

- Do not open foam agent supply tanks while performing flush procedures.
- Before flushing system make sure that FOAM SYSTEM switch is in off position (WP 0004).

- Step 7. Start water pump engine (WP 0022). Put pump operator's panel FOAM FLUSH switch to ON position (WP 0004). Flush foam system (WP 0031). Put pump operator's panel FOAM FLUSH switch to OFF position (WP 0004). Put cab FOAM SYSTEM switch to on position (WP 0004). Put FOAM SELECT switch to "A" position (WP 0004). Put TANK TO PUMP switch to ON position (WP 0004). Put GROUND SWEEPS switch to on position (WP 0004). Flush foam system (WP 0031). Retest system with foam B selected. Check if foam is delivered from under truck nozzles in either foam A or foam B.
- a. If foam is delivered from ground sweeps, fault corrected.
  - b. If foam is not delivered from ground sweeps, replace foam system multi-metering valve (WP 0292).

**MALFUNCTION**

**TEST OR INSPECTION**

**CORRECTIVE ACTION**

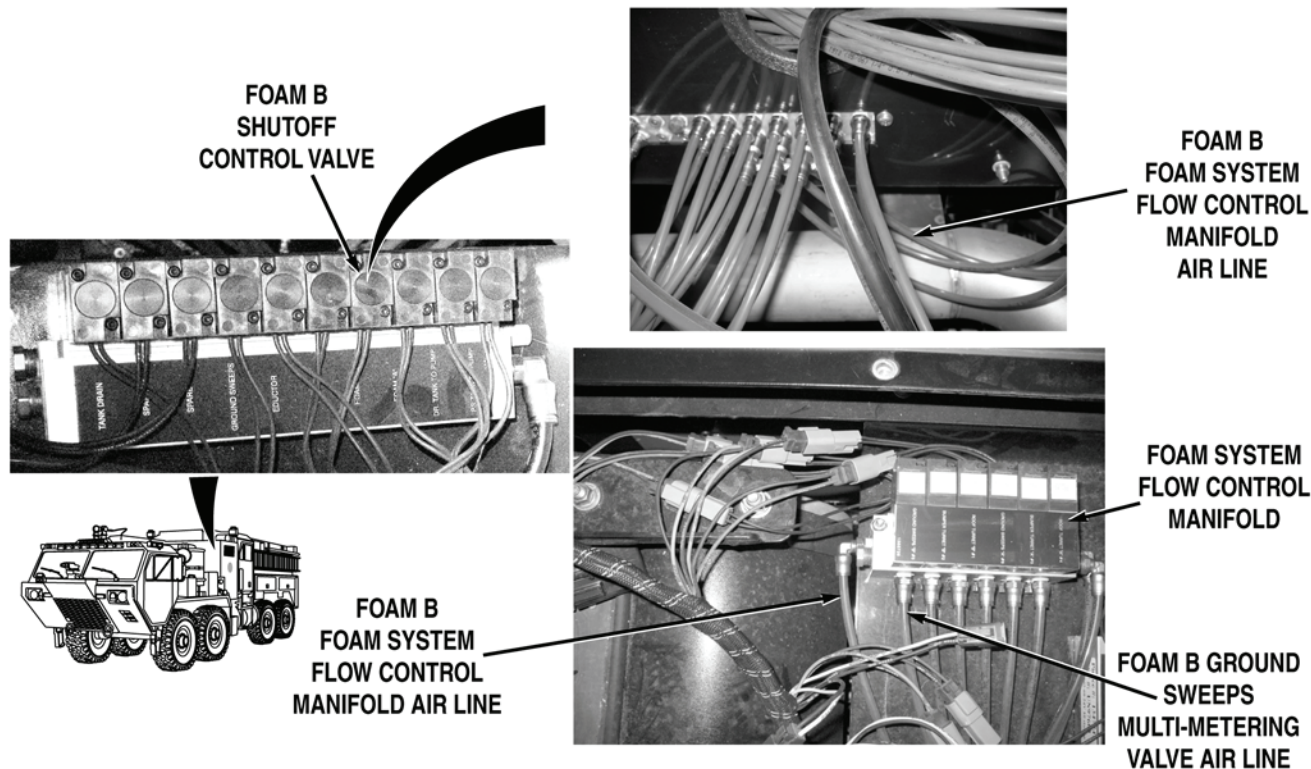

Step 8. Remove pump house panel S (WP 0540). Put cab FOAM SYSTEM switch to off position (WP 0004). Put GROUND SWEEPS switch to off position (WP 0004). Check air lines from FOAM B shutoff valve control manifold to foam system flow control manifold for leaks, kinks, or damage.

If air lines are not free from leaks, kinks, or damage, replace damaged air lines (WP 0567).

Step 9. Check lines from GROUND SWEEPS FOAM B foam system flow control manifold to ground sweeps foam B multi-metering valve cylinder for leaks, kinks, or damage.

If air lines are not free from leaks, kinks, or damage, replace damaged air lines (WP 0567).

**MALFUNCTION****TEST OR INSPECTION****CORRECTIVE ACTION**

**GROUND SWEEPS FOAM B  
MULTI-METERING  
VALVE CYLINDER**

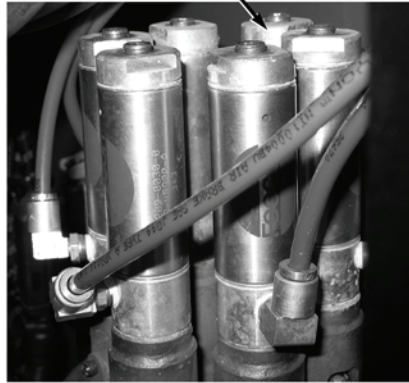

**AIR LINE AT GROUND SWEEPS  
FOAM B MULTI-METERING  
VALVE CYLINDER**

**WARNING**

- If air lines are under pressure when they are disconnected, they can whip around and cause injury to personnel. Caution should be exercised when disconnecting air line fittings.
- Air lines may be under pressure when control valve is operated. If under pressure and air lines are disconnected, air lines may whip around and cause injury to personnel. Caution should be exercised when operating control valve with air lines disconnected.

Step 10. Disconnect air line at ground sweeps foam B multi-metering valve cylinder. While an assistant puts GROUND SWEEPS switch to ON position (WP 0004). Put cab FOAM SYSTEM switch to ON position (WP 0004). Put cab FOAM SELECT switch to B position (WP 0004), check if air pressure is present at ground sweeps foam B multi-metering valve cylinder.

If there is air pressure, replace foam system multi-metering valve (WP 0292).

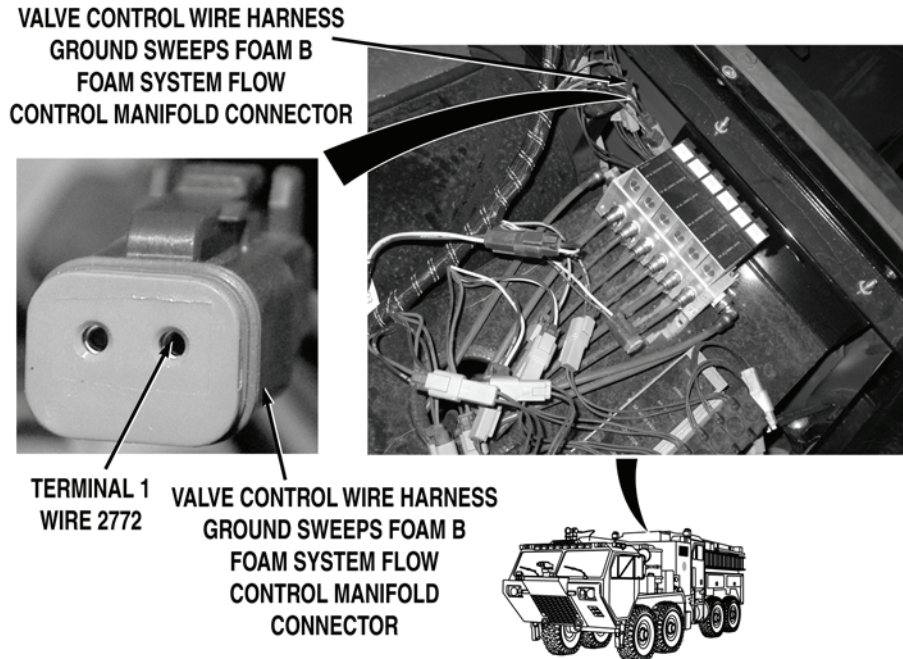
**MALFUNCTION****TEST OR INSPECTION****CORRECTIVE ACTION**

- Step 11. Put cab FOAM SYSTEM switch to OFF position (WP 0004). Reconnect air line at ground sweeps foam B multi-metering valve cylinder. Disconnect valve control wire harness GROUND SWEEPS FOAM B foam system flow control manifold connector. Put cab FOAM SYSTEM switch to ON position (WP 0004). Put cab FOAM SELECT switch to B position (WP 0004), with a test lead set, check for 22 to 28 VDC between valve control wire harness wire 2772 (gray) at ground sweeps foam B foam system flow control manifold connector, terminal 1, and a known good ground.

If 22 to 28 VDC are not present, repair wire 2772 in valve control wire harness if repairable (TM 9-2320-325-14&P), or replace valve control wire harness (WP 0463).

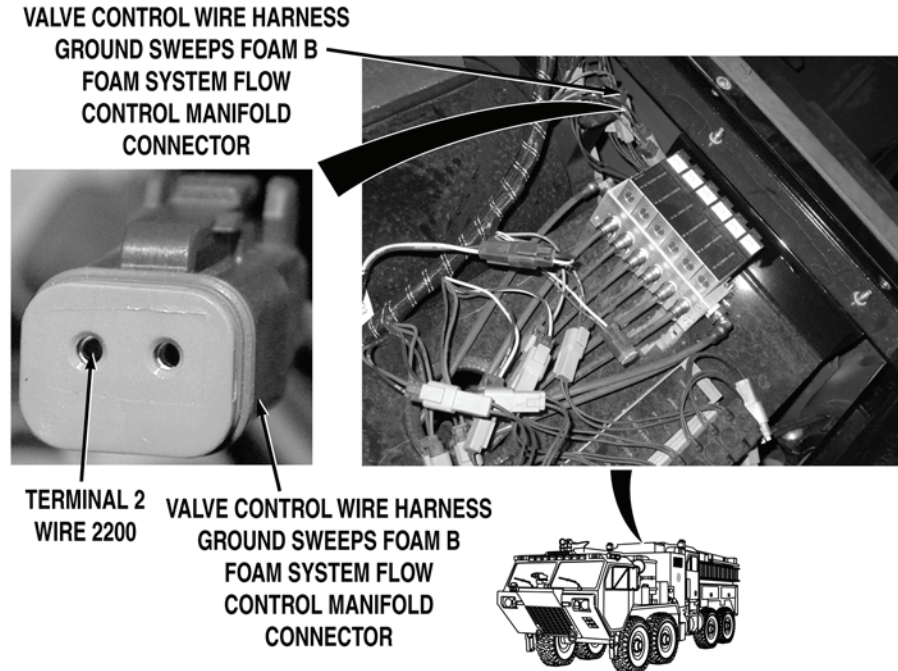

**MALFUNCTION****TEST OR INSPECTION****CORRECTIVE ACTION**

- Step 12. Put GROUND SWEEPS switch to OFF position (WP 0004). Turn battery disconnect switch to OFF position (WP 0004). With a test lead set, check for continuity across wire 2200 (black) from valve control wire harness ground sweeps foam B foam system flow control manifold connector, terminal 2 to a known good ground.
- a. If there is continuity, replace GROUND SWEEPS FOAM B metering control valve (WP 0288).
  - b. If there is no continuity, repair wire 2200 in valve control wire harness if repairable (TM 9-2320-325-14&P), or replace valve control wire harness (WP 0463).

**MALFUNCTION**

**TEST OR INSPECTION**

**CORRECTIVE ACTION**

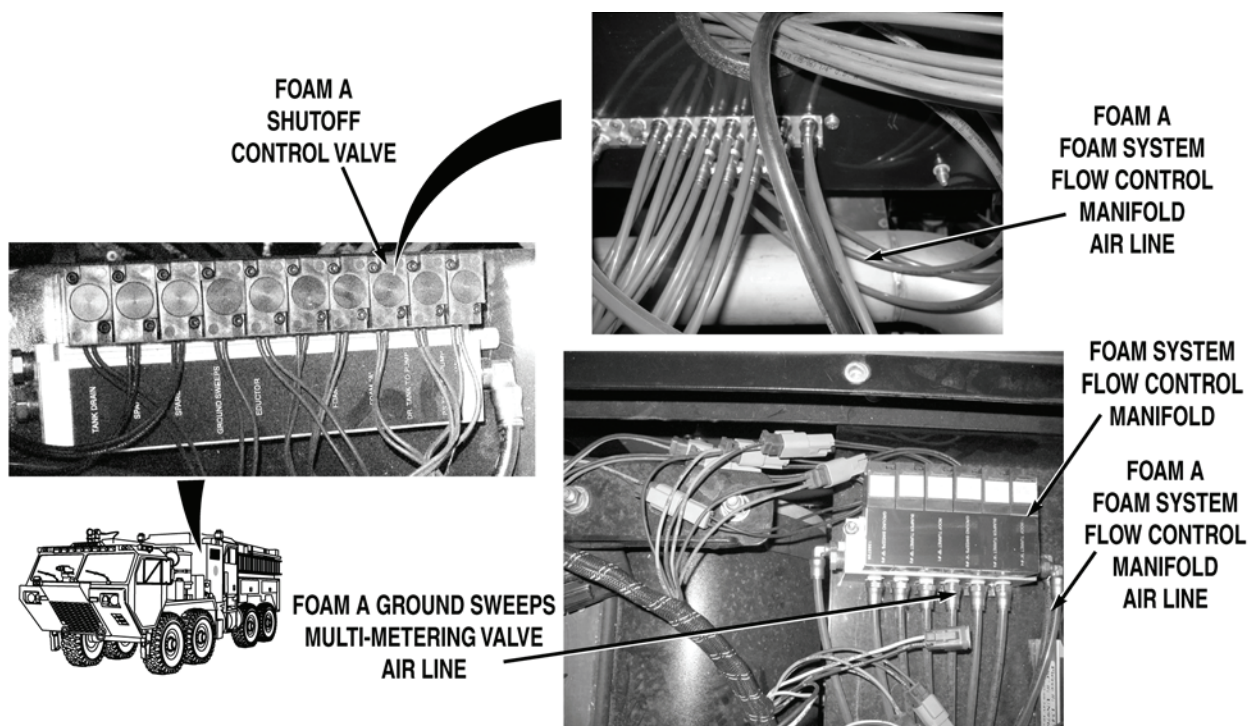

Step 13. Remove pump house panel S (WP 0540). Put cab FOAM SYSTEM switch to OFF position (WP 0004). Put GROUND SWEEPS switch to OFF position (WP 0004). Check air lines from FOAM A shutoff valve control manifold to foam system flow control manifold for leaks, kinks, or damage.

If air lines are not free from leaks, kinks, or damage, replace damaged air lines (WP 0567).

Step 14. Check lines from GROUND SWEEPS FOAM A foam system flow control manifold to ground sweeps foam A multi-metering valve cylinder for leaks, kinks or damage.

If air lines are not free from leaks, kinks, or damage, replace damaged air lines (WP 0567).

---

<b>MALFUNCTION</b>	
<b>TEST OR INSPECTION</b>	
<b>CORRECTIVE ACTION</b>	

---



GROUND SWEEPS FOAM A  
MULTI-METERING  
VALVE CYLINDER

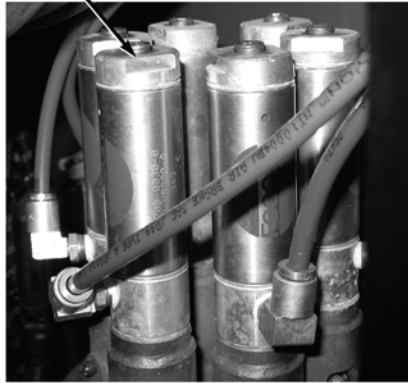

AIR LINE AT GROUND SWEEPS  
FOAM A MULTI-METERING  
VALVE CYLINDER



**WARNING**



- If air lines are under pressure when they are disconnected, they can whip around and cause injury to personnel. Caution should be exercised when disconnecting air line fittings.
- Air lines may be under pressure when control valve is operated. If under pressure and air lines are disconnected, air lines may whip around and cause injury to personnel. Caution should be exercised when operating control valve with air lines disconnected.

Step 15. Disconnect air line at ground sweeps foam A multi-metering valve cylinder. While an assistant puts GROUND SWEEPS switch to ON position (WP 0004). Put cab FOAM SYSTEM switch to ON position (WP 0004). Put cab FOAM SELECT switch to "A" position (WP 0004), check if air pressure is present at ground sweeps foam A multi-metering valve cylinder.

If there is air pressure, replace foam system multi-metering valve (WP 0292).

**MALFUNCTION**

**TEST OR INSPECTION**

**CORRECTIVE ACTION**

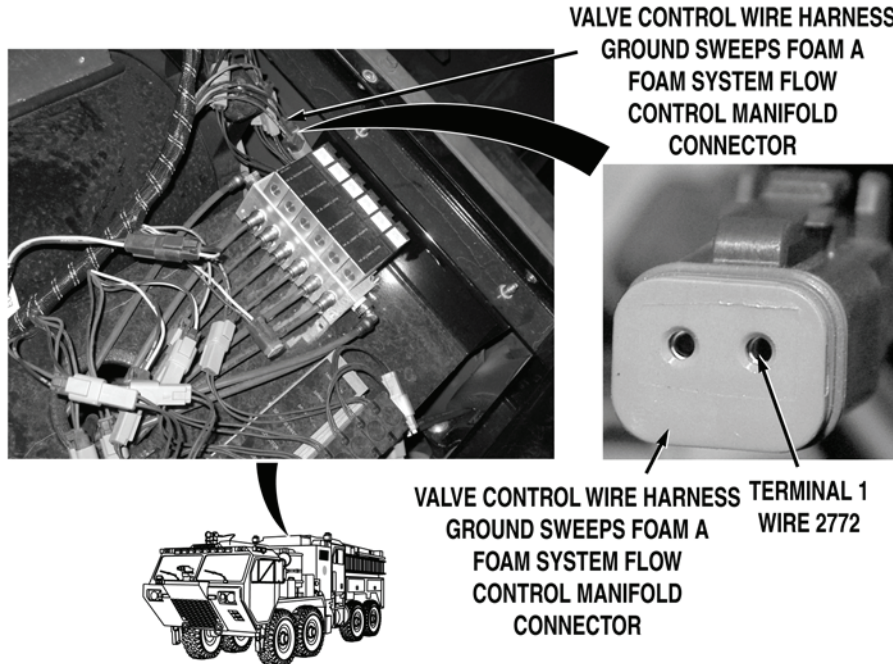

Step 16. Put cab FOAM SYSTEM switch to OFF position (WP 0004). Turn battery disconnect switch to OFF position (WP 0007). Reconnect air line at ground sweeps foam A multi-metering valve cylinder. Disconnect valve control wire harness ground sweeps foam A foam system flow control manifold connector. Turn battery disconnect switch to ON position (WP 0007). Put cab FOAM SYSTEM switch to ON position (WP 0004). Put cab FOAM SELECT switch to "A" position (WP 0004). Put GROUND SWEEPS switch to ON position (WP 0004), with a test lead set, check for 22 to 28 VDC between valve control wire harness wire 2772 (gray) at GROUND SWEEPS FOAM A foam system flow control manifold connector, terminal 1, and a known good ground.

If 22 to 28 VDC are not present, repair wire 2772 in valve control wire harness if repairable (TM 9-2320-325-14&P), or replace valve control wire harness (WP 0463).

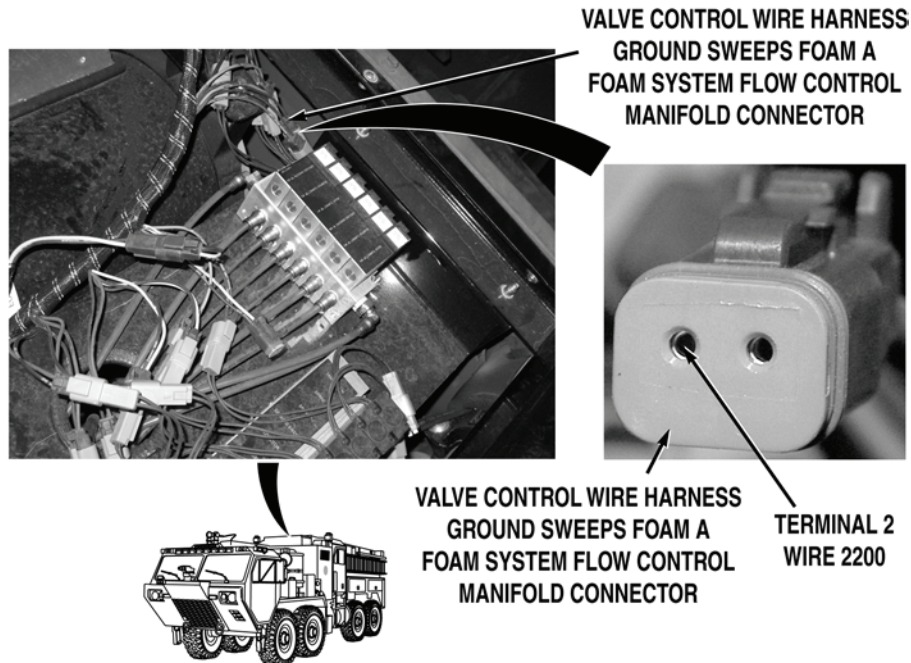
**MALFUNCTION****TEST OR INSPECTION****CORRECTIVE ACTION**

- Step 17. Put GROUND SWEEPS switch to OFF position (WP 0004). Turn battery disconnect switch to OFF position (WP 0004). With a test lead set, check for continuity across wire 2200 (black) from valve control wire harness GROUND SWEEPS FOAM A foam system flow control manifold connector, terminal 2 to a known good ground.
- a. If there is continuity, replace GROUND SWEEPS FOAM A metering control valve (WP 0288).
  - b. If there is no continuity, repair wire 2200 in valve control wire harness if repairable (TM 9-2320-325-14&P), or replace valve control wire harness (WP 0463).

**END OF TASK****FOLLOW-ON MAINTENANCE**

Remove wheel chocks (TM 9-2320-347-10)

**END OF TASK****END OF WORK PACKAGE**



**FIELD LEVEL MAINTENANCE**

**FOAM NOT DELIVERED WHEN MANUAL METERING CONTROL IS OPERATED**

**INITIAL SETUP:**

**Tools and Special Tools**

Tool Kit, General Mechanic's: Automotive  
(WP 0622, Item 27)

**Personnel Required**

MOS 63B Wheeled vehicle mechanic (2)

**References**

WP 0004  
WP 0007  
WP 0032  
WP 0033

**References (continued)**

WP 0094  
WP 0095  
WP 0096  
WP 0291  
WP 0490  
WP 0539

**Equipment Conditions**

Water pump engine OFF (WP 0022)  
Engine OFF (TM 9-2320-347-10)  
Wheels chocked (TM 9-2320-347-10)

**MALFUNCTION**

**TEST OR INSPECTION**

**CORRECTIVE ACTION**

**FOAM NOT DELIVERED WHEN MANUAL METERING CONTROL IS OPERATED**



MANUAL METERING  
CONTROL VALVE TUBING

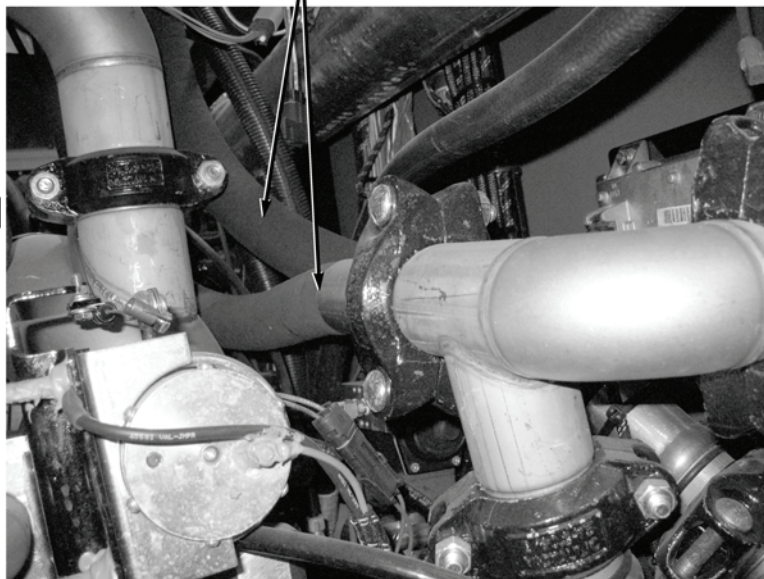

Step 1. Open pump house panel A (WP 0539). Inspect tubing between manual metering control valve and multi-metering valve for leaks, kinks, or damage.

If tubing is not free from leaks, kinks, or damage, replace damaged tubing (WP 0490).

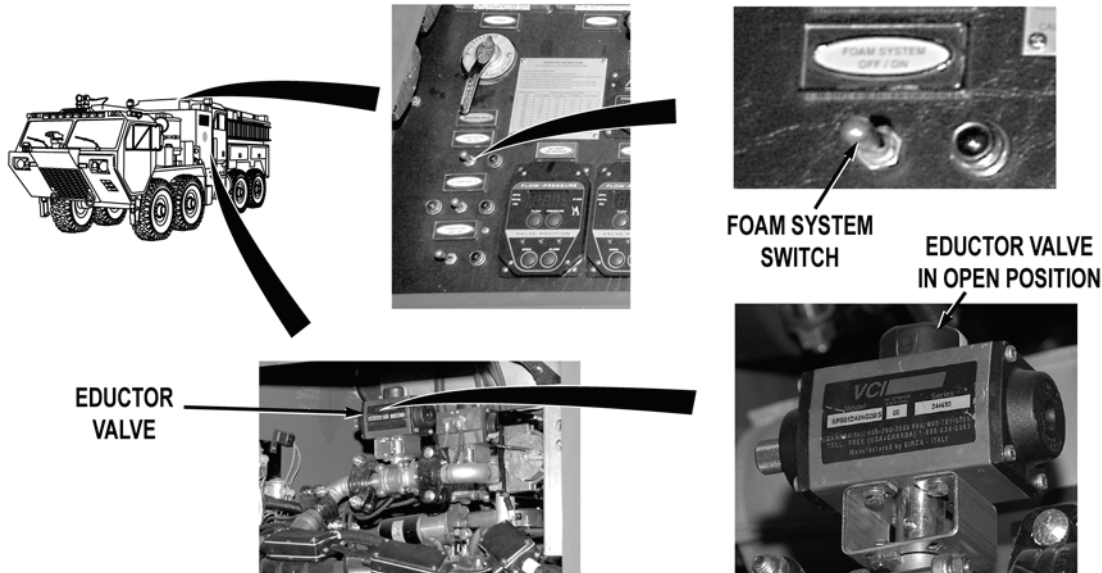
**MALFUNCTION****TEST OR INSPECTION****CORRECTIVE ACTION****NOTE**

- Ensure system air pressure is at least 85 psi (586 kPa) during this procedure. System air pressure is required to activate valves.
- Do not operate water pump engine during this procedure, except when performing complete system checks. Valve operations can be checked without water pump operation.
- Valve operations can be checked by observing valve shaft rotation. Valves are open when tabs or yellow paint tabs are aligned with direction of fluid flow.

Step 2. Turn battery disconnect switch to ON position (WP 0007). If system air pressure is below 85 psi (586 kPa), start engine and allow system air pressure to build to at least 85 psi (586 kPa) (TM 9-2320-347-10). Shut off engine (TM 9-2320-347-10). While an assistant puts cab or pump operator's panel FOAM SYSTEM switch to on position (WP 0004), check if eductor valve operate to open position.

If eductor valve does not operate to open position, troubleshoot Foam Not Delivered From All Systems (Bumper Turret, Ground Sweeps, and Manual Metering Controls) or System Does Not Shut Off (WP 0094).

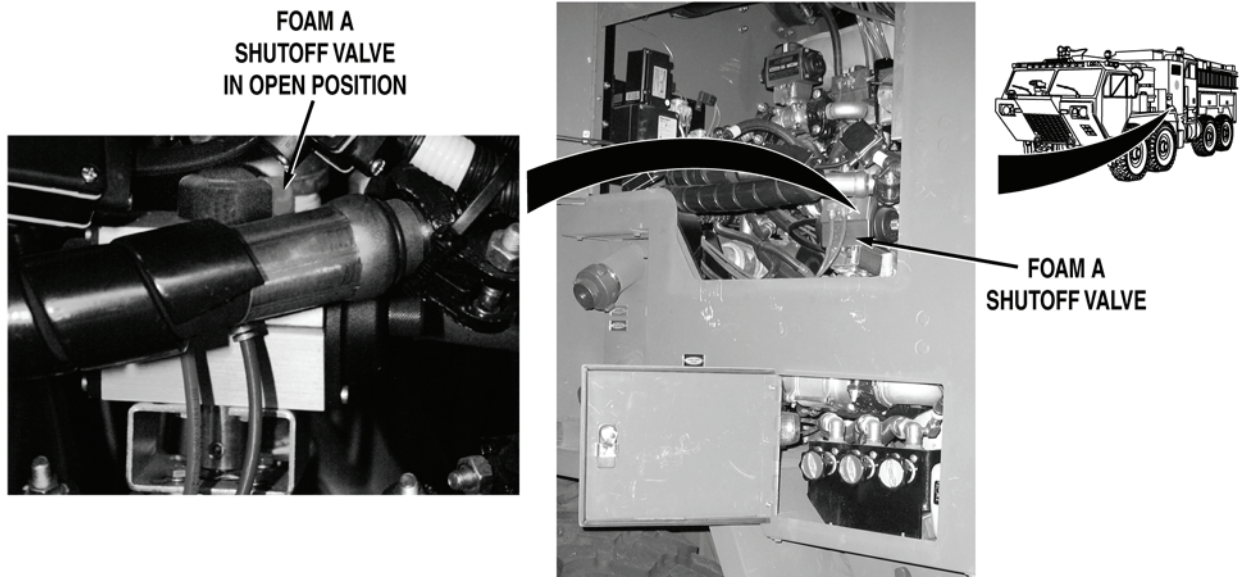

**MALFUNCTION****TEST OR INSPECTION****CORRECTIVE ACTION**

- Step 3. While an assistant puts cab or pump operator's panel FOAM TANK switch "A" to on position (WP 0004), check if foam A shutoff valve operates to open position.

If foam A shutoff valve does not operate to open position, troubleshoot Foam Not Delivered When Tank A is Selected (Bumper Turret, Ground Sweeps, and Manual Metering Controls) (WP 0095).

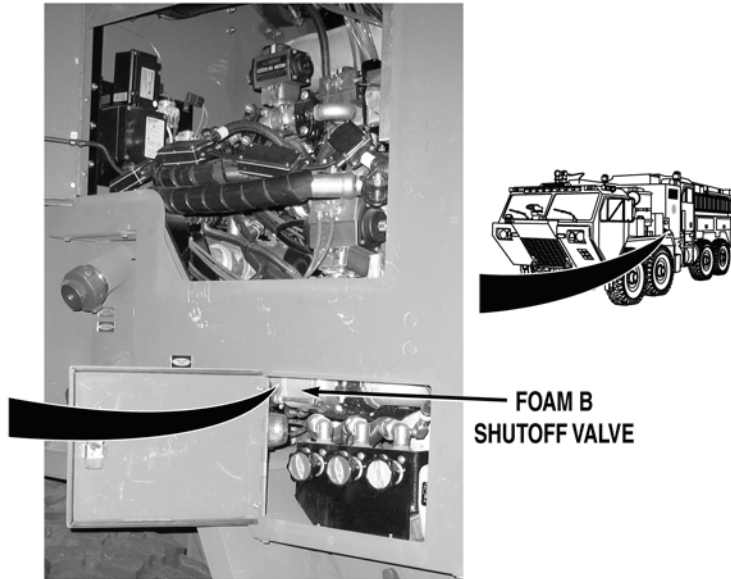
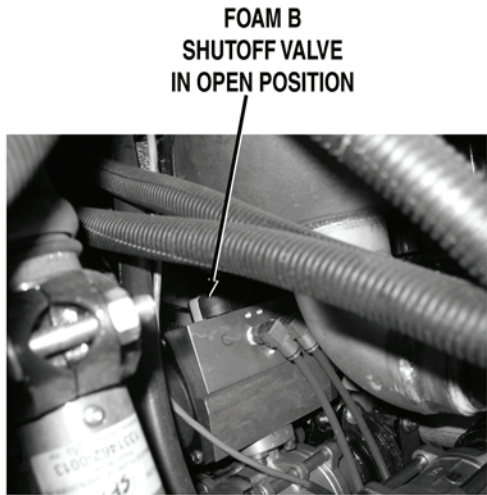
**MALFUNCTION****TEST OR INSPECTION****CORRECTIVE ACTION**

- Step 4. While an assistant puts cab or pump operator's panel FOAM TANK switch to "B" position (WP 0004), check if foam B shutoff valve operates to open position.

If foam B shutoff valve does not operate to open position, troubleshoot Foam Not Delivered When Tank B is Selected (Bumper Turret, Under Truck Nozzles, and Manual Metering Controls) (WP 0096).

**MALFUNCTION**  
**TEST OR INSPECTION**  
**CORRECTIVE ACTION**

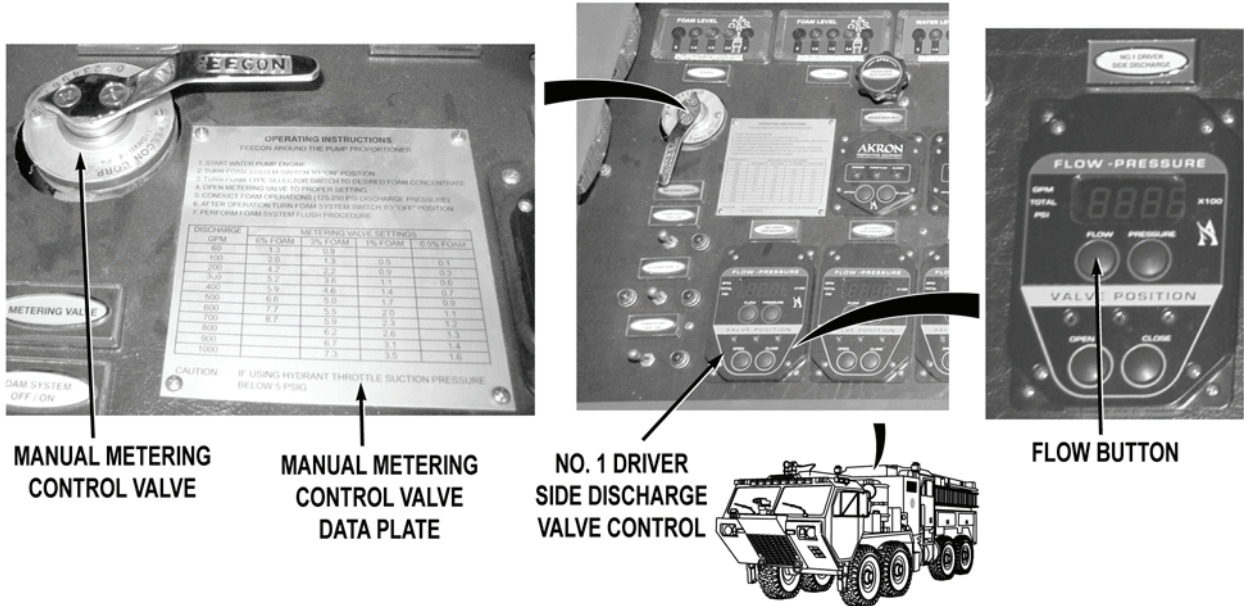

Step 5. Operate foam system from pump operator's panel (WP 0033). Push NO. 1 DRIVER SIDE DISCHARGE valve control FLOW button (WP 0004). Ensure that manual metering valve is set to match output of NO. 1 DRIVER SIDE DISCHARGE valve control (WP 0033). Set manual metering control valve to proper adjustment using manual metering control valve data plate valve settings. Check if foam is delivered when system is operated. Turn off foam system (WP 0033). Flush foam system (WP 0032).

- a. If foam is delivered, fault corrected.
- b. If foam is not delivered, replace manual metering valve (WP 0291).

**END OF TASK**

**FOLLOW-ON MAINTENANCE**

Remove wheel chocks (TM 9-2320-347-10)

**END OF TASK**

**END OF WORK PACKAGE**



**FIELD LEVEL MAINTENANCE**

**FOAM SYSTEM CANNOT BE FLUSHED**

**INITIAL SETUP:**

**Tools and Special Tools**

Lead Set, Test (WP 0622, Item 21)  
 Tool Kit, General Mechanic's: Automotive  
 (WP 0622, Item 27)

WP 0398  
 WP 0426  
 WP 0427  
 WP 0441  
 WP 0455  
 WP 0459  
 WP 0463  
 WP 0490  
 WP 0499  
 WP 0539  
 WP 0540  
 WP 0567

**References**

TM 9-2320-325-14&P  
 WP 0004  
 WP 0007  
 WP 0019  
 WP 0094  
 WP 0280  
 WP 0289  
 WP 0311  
 WP 0325

**Equipment Conditions**

Water pump engine OFF (WP 0022)  
 Engine OFF (TM 9-2320-347-10)  
 Wheels chocked (TM 9-2320-347-10)

**References (continued)**

WP 0338

**MALFUNCTION**

**TEST OR INSPECTION**

**CORRECTIVE ACTION**

**FOAM SYSTEM CANNOT BE FLUSHED**

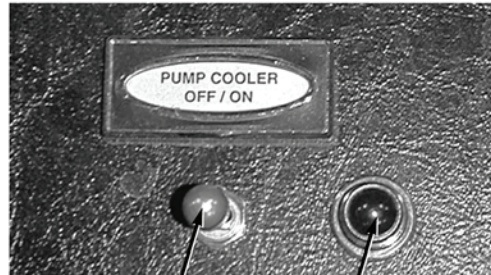
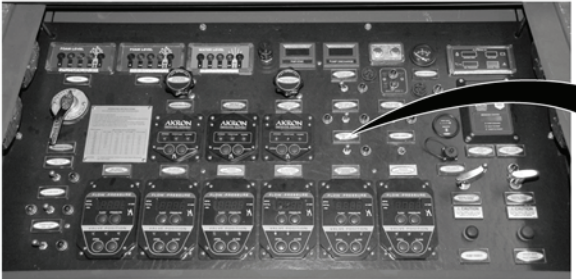
**MALFUNCTION****TEST OR INSPECTION****CORRECTIVE ACTION**

PUMP COOLER  
SWITCH

PUMP COOLER  
INDICATOR

**NOTE**

Foam system flush, water tank drain, and pump cooler systems share a common power source (wire 2834). Step 1 will determine if fault exists in power leading to foam flush switch.

- Step 1. Turn battery disconnect switch to ON position (WP 0007). Open pump operator's panel (WP 0019). Put pump operator's panel PUMP COOLER switch to ON position (WP 0004). Check if PUMP COOLER indicator illuminates.

If PUMP COOLER indicator does not illuminate, go to Step 15.

---

**MALFUNCTION**  
**TEST OR INSPECTION**  
**CORRECTIVE ACTION**

---

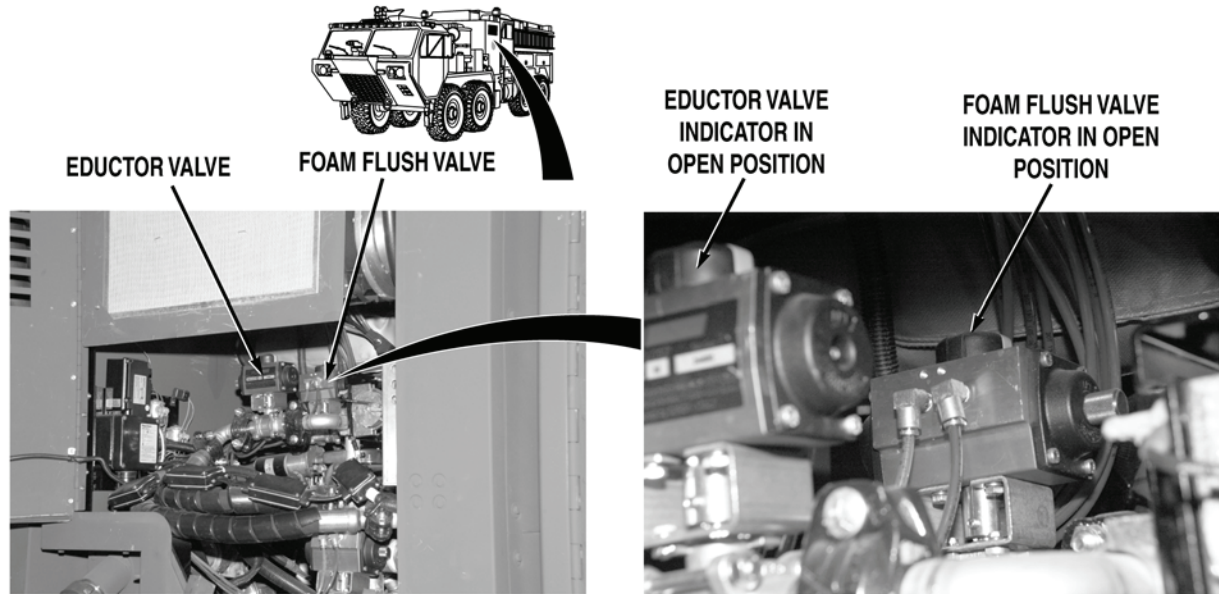

**NOTE**

- Ensure system air pressure is at least 85 psi (586 kPa) during this procedure. System air pressure is required to activate valves.
- Do not engage water pump engine during this procedure, except when performing complete system checks. Valve operations can be checked without water pump operation.
- Valve operations can be checked by observing valve shaft rotation. Valves are open when tabs or yellow paint tabs are aligned with direction of fluid flow.

Step 2. Put pump operator's panel PUMP COOLER switch to OFF position (WP 0004). If system air pressure is below 85 psi (586 kPa), start vehicle engine and allow system air pressure to build to at least 85 psi (586 kPa) (TM 9-2320-347-10). Then shut off engine (TM 9-2320-347-10). Open pump house panel A (WP 0539). While an assistant puts pump operator's panel FOAM FLUSH switch to ON position (WP 0004), check if foam flush valve operates to open position.

If foam flush valve does not operate to open position, go to Step 6.

Step 3. While an assistant puts pump operator's panel FOAM FLUSH switch to OFF and back to ON position (WP 0004), check if eductor valve operates to open position.

If eductor valve does not operate to open position, go to Step 5.

---

**MALFUNCTION****TEST OR INSPECTION****CORRECTIVE ACTION**

---

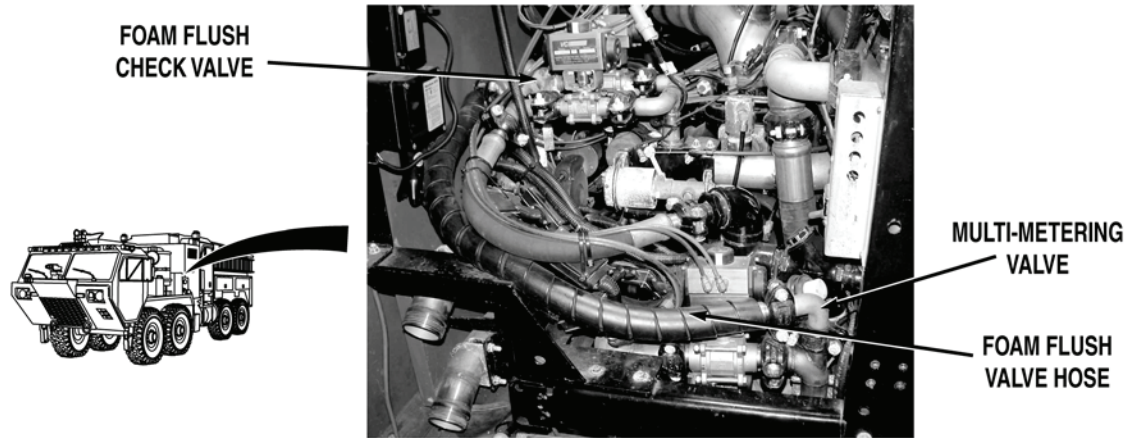

- Step 4. Put FOAM FLUSH switch to OFF position (WP 0004). Inspect foam flush valve hose between foam flush check valve and multi-metering valve for kinks and damage.
- a. If foam flush valve tubing is free from kinks and/or damage, clean or replace foam flush check valve (WP 0280).
  - b. If foam flush valve hose is kinked or damaged, replace damaged foam flush valve hose (WP 0490).



---

MALFUNCTION	TEST OR INSPECTION	CORRECTIVE ACTION
-------------	--------------------	-------------------

---

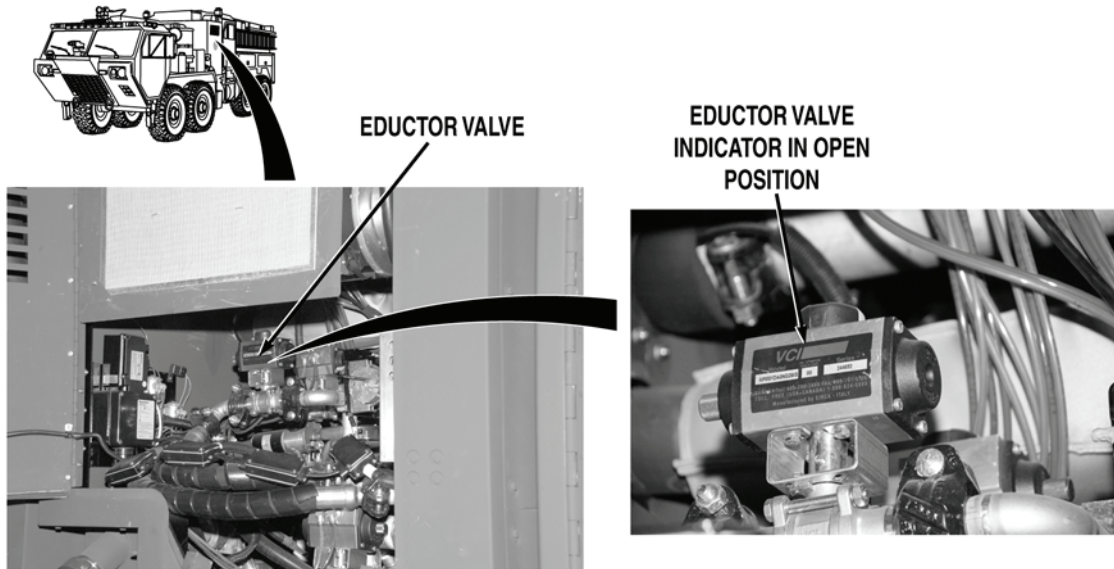

- Step 5. Put pump operator's panel FOAM FLUSH switch to OFF position (WP 0004). While an assistant puts pump operator's panel FOAM SYSTEM switch to ON position (WP 0004), check if eductor valve operates to open position.
- If eductor valve operates to open position, replace foam flush shutoff control diode pack (WP 0426).
  - If eductor valve does not operate to open position, troubleshoot Foam Not Delivered From All Systems (Bumper Turret, Ground Sweeps, and Manual Metering Controls) or System Does Not Shut Off (WP 0094).

---

**MALFUNCTION****TEST OR INSPECTION****CORRECTIVE ACTION**

---

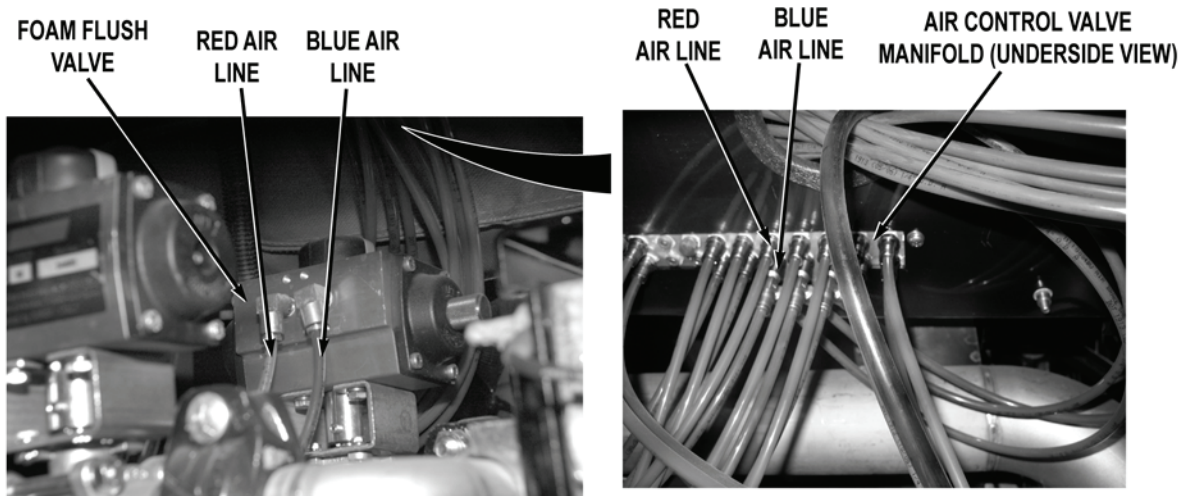

- Step 6. Put pump operator's panel FOAM FLUSH switch to OFF position (WP 0004). Inspect red and blue air lines from air control valve manifold to foam flush valve for kinks and damage.

If air lines are kinked or damaged, replace air lines (WP 0567).

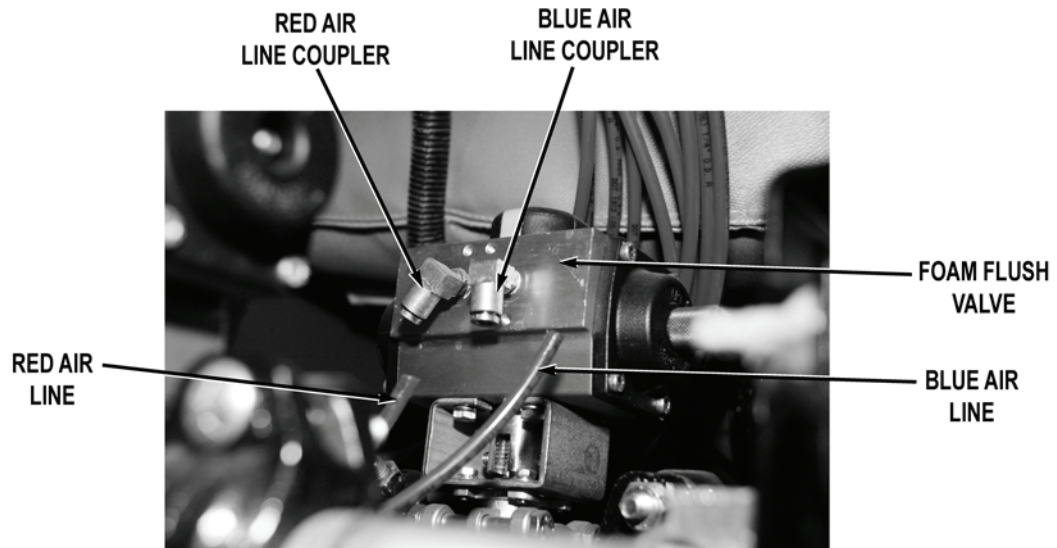
**MALFUNCTION****TEST OR INSPECTION****CORRECTIVE ACTION****WARNING**

- If air lines are under pressure when they are disconnected, they can whip around and cause injury to personnel. Caution should be exercised when disconnecting air line fittings.
- Air lines may be under pressure when control valve is operated. If under pressure and air lines are disconnected, air lines may whip around and cause injury to personnel. Caution should be exercised when operating control valve with air lines disconnected.

**NOTE**

Air pressure is checked by disconnecting air lines at foam flush valve and observing air pressure escaping from air line, when foam flush control valve is activated. Air will escape from blue air line when FOAM FLUSH switch is put to ON position, and escape from red air line when FOAM FLUSH switch is put to OFF position. System air pressure may drop below 85 psi (586 kPa) during this procedure.

- Step 7. Disconnect air lines at foam flush valve. While an assistant puts pump operator's panel FOAM FLUSH switch to ON and OFF positions (WP 0004), check if air pressure is present at foam flush valve.

If there is air pressure, replace foam flush valve (WP 0289).

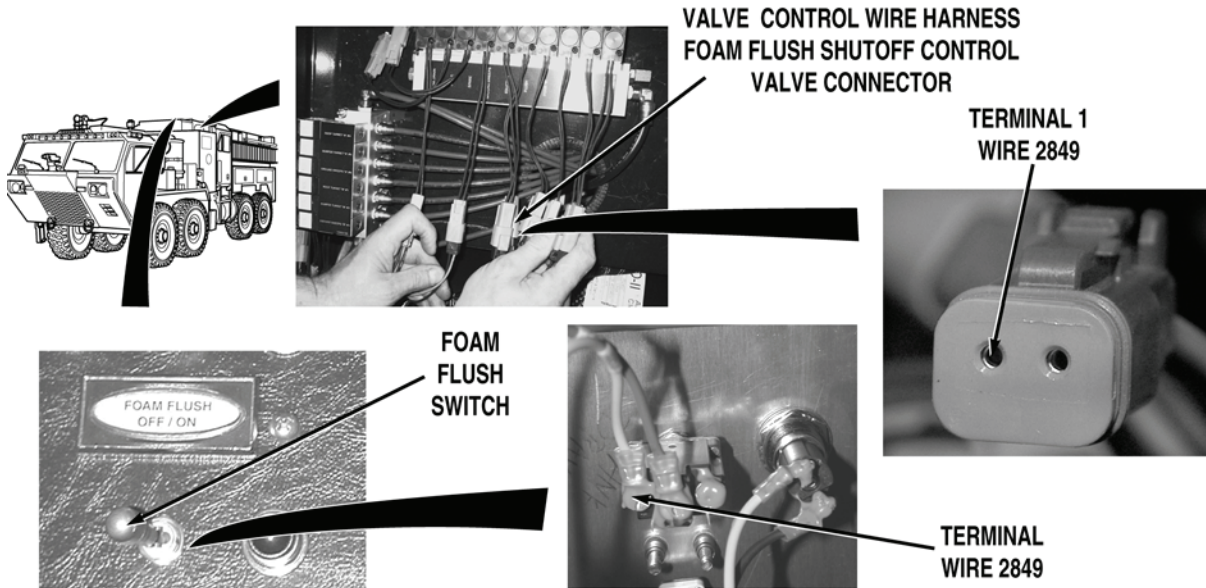
**MALFUNCTION****TEST OR INSPECTION****CORRECTIVE ACTION****WARNING**

**Remove rings, wristwatches, neck chains, and any other jewelry before working around vehicle. Jewelry can catch on equipment and cause serious injury. Jewelry and tools may short across electrical circuits and cause damage to equipment, or severe burns or electrical shock to personnel.**

- Step 8. Turn battery disconnect switch to OFF position (WP 0007). Disconnect valve control wire harness foam flush shutoff control valve connector. Turn battery disconnect switch to ON position (WP 0007). With a test lead set, check for 22 to 28 VDC between wire 2849 (yellow) at valve control wire harness foam flush shutoff control valve connector, terminal 1 and a known good ground.

If 22 to 28 VDC are present, go to Step 13.

- Step 9. Turn battery disconnect switch to OFF position (WP 0007). Open pump operator's panel housing (WP 0325). With a test lead set, check for continuity across wire 2849 (yellow) from pump operator's panel FOAM FLUSH switch, terminal to valve control wire harness foam flush shutoff control valve connector, terminal 1.

If there is continuity, go to Step 12.

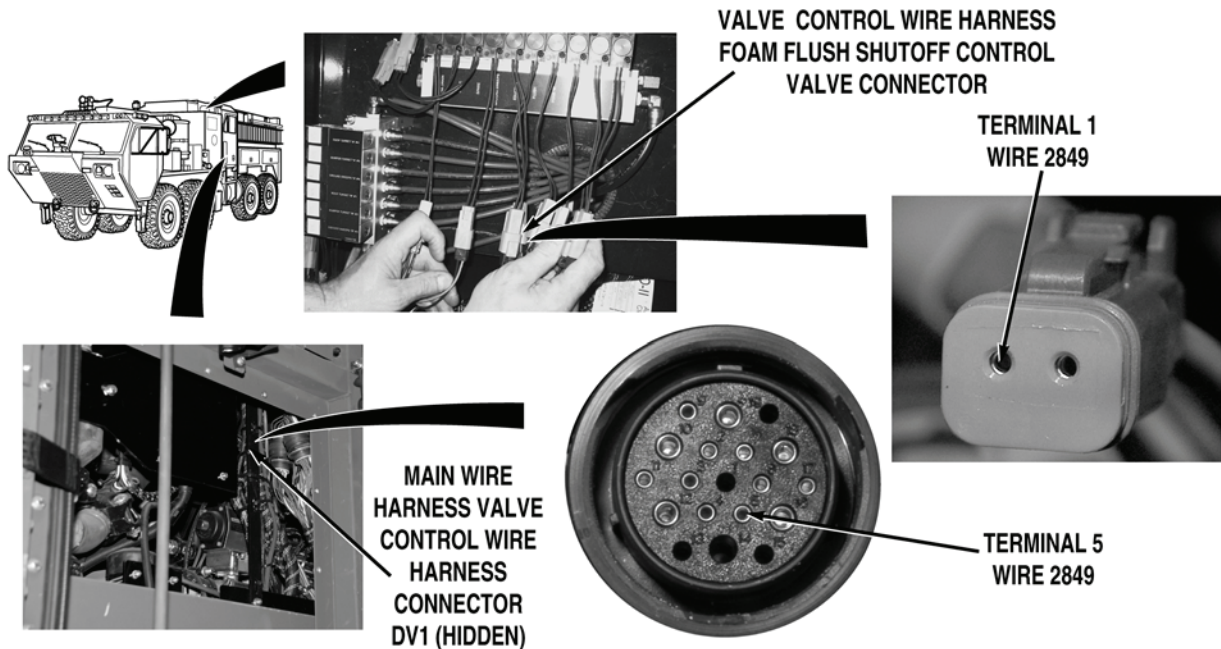
**MALFUNCTION****TEST OR INSPECTION****CORRECTIVE ACTION**

- Step 10. Remove driver side crew cab access panel (WP 0499). Remove pump house panel Q (WP 0540). Disconnect main wire harness valve control wire harness connector DV1. With a test lead set, check for continuity across valve control wire harness wire 2849 (yellow) from main wire harness valve control wire harness connector DV1, terminal 5 to valve control wire harness foam flush shutoff control valve connector, terminal 1.

If there is no continuity, repair wire 2849 in valve control wire harness if repairable (TM 9-2320-325-14&P), or replace valve control wire harness (WP 0463).

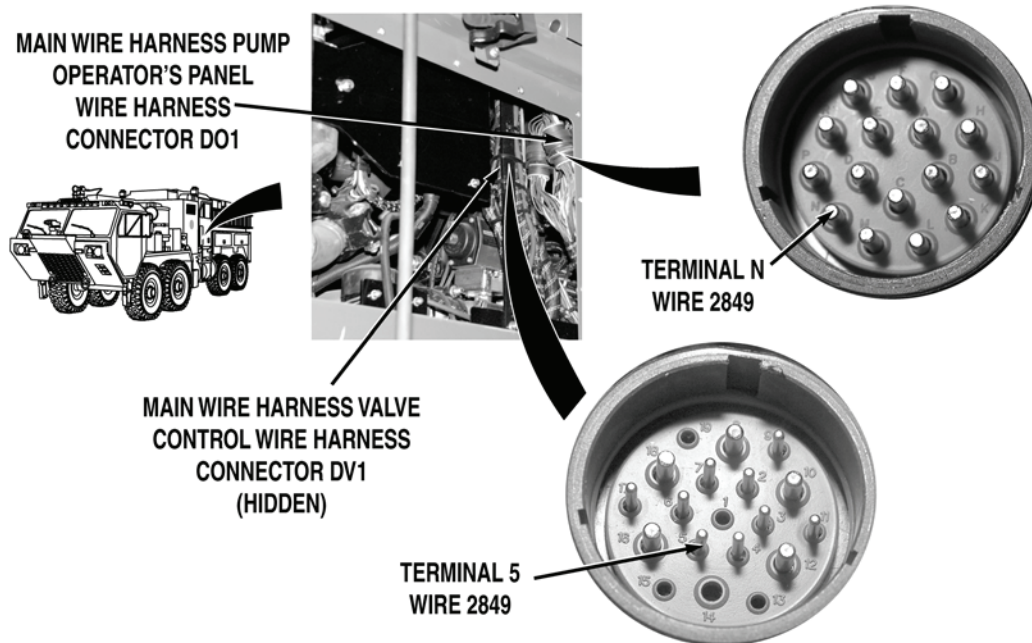
**MALFUNCTION****TEST OR INSPECTION****CORRECTIVE ACTION**

- Step 11. Disconnect main wire harness pump operator's panel wire harness connector DO1. With a test lead set, check for continuity across main wire harness wire 2849 (yellow) from main wire harness pump operator's panel wire harness connector DO1, terminal N to a main wire harness valve control wire harness connector DV1, terminal 5.
- a. If there is continuity, repair wire 2849 in pump operator's panel wire harness if repairable (TM 9-2320-325-14&P), or replace pump operator's panel wire harness (WP 0459).
  - b. If there is no continuity, repair wire 2849 in main wire harness if repairable (TM 9-2320-325-14&P), or replace main wire harness (WP 0455).

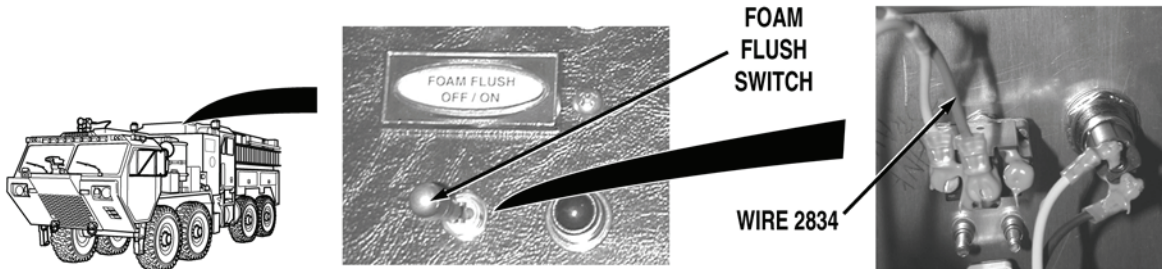
**MALFUNCTION****TEST OR INSPECTION****CORRECTIVE ACTION****WARNING**

**Remove rings, wristwatches, neck chains, and any other jewelry before working around vehicle. Jewelry can catch on equipment and cause serious injury. Jewelry and tools may short across electrical circuits and cause damage to equipment, or severe burns or electrical shock to personnel.**

- Step 12. Turn battery disconnect switch to ON position (WP 0007). Check for 22 to 28 VDC between wire 2834 (red) at FOAM FLUSH switch, terminal to a known good ground.
- a. If 22 to 28 VDC are not present, repair wire 2834 in pump operator's panel wire harness if repairable (TM 9-2320-325-14&P), or replace pump operator's panel wire harness (WP 0459).
  - b. If 22 to 28 VDC are present, replace FOAM FLUSH switch (WP 0338).

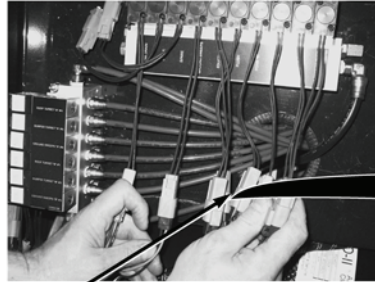
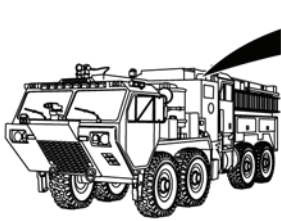
**MALFUNCTION****TEST OR INSPECTION****CORRECTIVE ACTION**

TERMINAL 2  
WIRE 2200

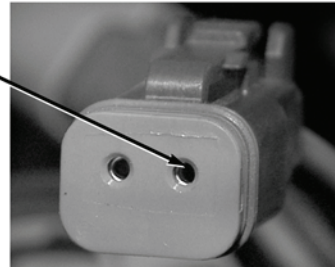

VALVE CONTROL WIRE HARNESS  
FOAM FLUSH SHUTOFF CONTROL  
VALVE CONNECTOR

**WARNING**

**Remove rings, wristwatches, neck chains, and any other jewelry before working around vehicle. Jewelry can catch on equipment and cause serious injury. Jewelry and tools may short across electrical circuits and cause damage to equipment, or severe burns or electrical shock to personnel.**

- Step 13. Turn battery disconnect switch to OFF position (WP 0007). With a test lead set, check for continuity across wire 2200 (black) from valve control wire harness foam flush shutoff control valve connector, terminal 2 to a known good ground.

If there is continuity, replace shutoff control valve manifold (WP 0427).

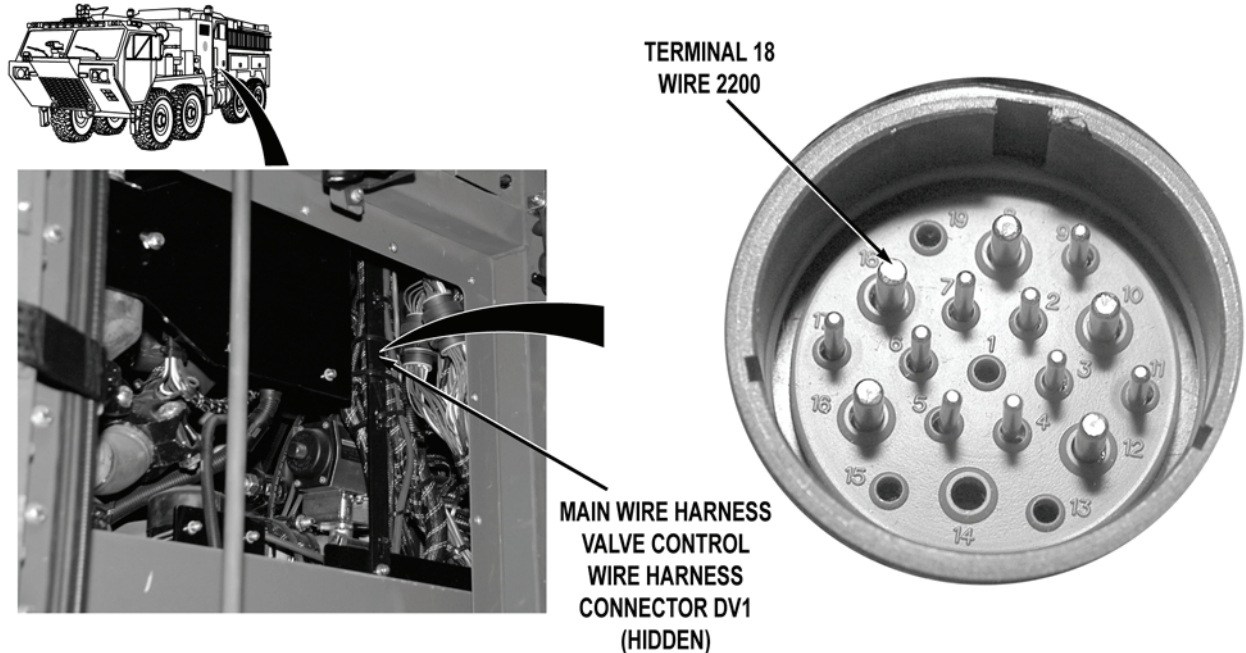

**MALFUNCTION****TEST OR INSPECTION****CORRECTIVE ACTION**

- Step 14. Remove driver side crew cab access panel (WP 0499). Remove pump house panel Q (WP 0540). Disconnect main wire harness valve control wire harness connector DV1. With a test lead set, check for continuity across main wire harness wire 2200 (black) from main wire harness valve control wire harness connector DV1, terminal 18 to a known good ground.
- a. If there is continuity, repair wire 2200 in valve control wire harness if repairable (TM 9-2320-325-14&P), or replace valve control wire harness (WP 0463).
  - b. If there is no continuity, repair wire 2200 in main wire harness if repairable (TM 9-2320-325-14&P), or replace main wire harness (WP 0455).

---

**MALFUNCTION****TEST OR INSPECTION****CORRECTIVE ACTION**

---

**PUMP COOLER  
INDICATOR****PUMP COOLER  
SWITCH**

- Step 15. Put pump operator's panel PUMP COOLER switch to OFF position (WP 0004). Put personnel cab PUMP COOLER switch to on position (WP 0004). Check if personnel cab PUMP COOLER OPEN indicator illuminates.

If personnel cab PUMP COOLER OPEN indicator illuminates, go to Step 17.

---

**MALFUNCTION**  
**TEST OR INSPECTION**  
**CORRECTIVE ACTION**

---

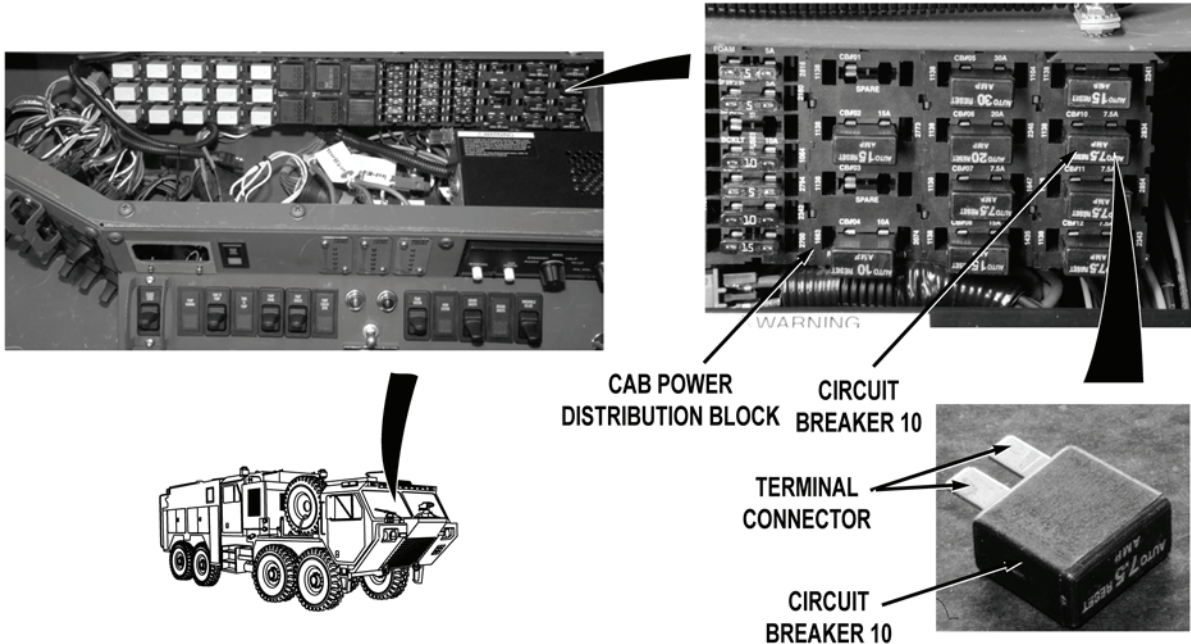

**WARNING**



Remove rings, wristwatches, neck chains, and any other jewelry before working around vehicle. Jewelry can catch on equipment and cause serious injury. Jewelry and tools may short across electrical circuits and cause damage to equipment, or severe burns or electrical shock to personnel.

- Step 16. Put personnel cab PUMP COOLER switch to off position (WP 0004). Turn battery disconnect switch to OFF position (WP 0007). Remove personnel cab instrument panel A (WP 0311). Remove circuit breaker 10 from cab power distribution block (WP 0398). Check for continuity across circuit breaker.
- a. If there is continuity, replace cab power distribution wire harness and block (WP 0441).
  - b. If there is no continuity, replace circuit breaker 10 (WP 0398).

**MALFUNCTION****TEST OR INSPECTION****CORRECTIVE ACTION**

MAIN WIRE HARNESS PUMP  
OPERATOR'S PANEL  
WIRE HARNESS CONNECTOR D01

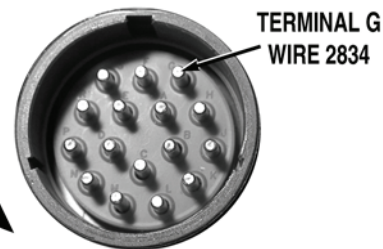
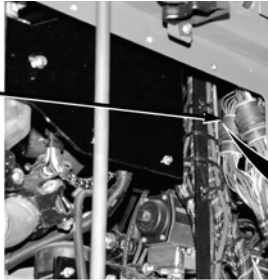
**WARNING**

**Remove rings, wristwatches, neck chains, and any other jewelry before working around vehicle. Jewelry can catch on equipment and cause serious injury. Jewelry and tools may short across electrical circuits and cause damage to equipment, or severe burns or electrical shock to personnel.**

- Step 17. Remove driver side crew cab access panel (WP 0499). Remove pump house panel Q (WP 0540). Disconnect main wire harness pump operator's panel wire harness connector DO1. With a test lead set, check for 22 to 28 VDC between main wire harness wire 2834 (red) from main wire harness pump operator's panel wire harness DO1, terminal G to a known good ground.
- a. If 22 to 28 VDC are present, repair 2834 in pump operator's panel wire harness if repairable (TM 9-2320-325-14&P), or replace pump operator's panel wire harness (WP 0459).
  - b. If 22 to 28 VDC are not present, repair wire 2834 in main wire harness if repairable (TM 9-2320-325-14&P), or replace main wire harness (WP 0455).

**END OF TASK****FOLLOW-ON MAINTENANCE**

Close pump operator's panel (WP 0019)

Install driver side crew cab access panel if removed (WP 0499)

Install pump house panel Q if removed (WP 0540)

Remove wheel chocks (TM 9-2320-347-10)

**END OF TASK****END OF WORK PACKAGE**

**FIELD LEVEL MAINTENANCE**

**FOAM A TANK LEVEL INDICATOR GAUGE DOES NOT OPERATE PROPERLY**

**INITIAL SETUP:**

**Tools and Special Tools**

Lead Set, Test (WP 0622, Item 21)  
 Tool Kit, General Mechanic's: Automotive  
 (WP 0622, Item 27)

**Personnel Required**

MOS 63B Wheeled vehicle mechanic (2)

**References**

TM 9-2320-325-14&P  
 WP 0004  
 WP 0007  
 WP 0015  
 WP 0019  
 WP 0031  
 WP 0191  
 WP 0281  
 WP 0311  
 WP 0316

**References (continued)**

WP 0322  
 WP 0325  
 WP 0401  
 WP 0439  
 WP 0441  
 WP 0443  
 WP 0455  
 WP 0459  
 WP 0499  
 WP 0540  
 WP 0550

**Equipment Conditions**

Water pump engine OFF (WP 0022)  
 Engine OFF (TM 9-2320-347-10)  
 Parking brake applied (TM 9-2320-347-10)  
 Wheels chocked (TM 9-2320-347-10)

**MALFUNCTION**

**TEST OR INSPECTION**

**CORRECTIVE ACTION**

**FOAM A TANK LEVEL INDICATOR GAUGE DOES NOT OPERATE PROPERLY**

**NOTE**

- FOAM LEVEL indicators operate as follows: "E" indicator will flash when the foam level in tank is below 1/4 full. Indicators "E" and "1/4" will illuminate when foam tank is 1/4 full. Indicators "E", "1/4", and "1/2" will illuminate when foam tank is 1/2 full. Indicators "E", "1/4", "1/2", and "3/4" will illuminate when foam tank is 3/4 full. And indicators "E", "1/4", "1/2", "3/4", and "FULL" will illuminate when foam tank is full.
- FOAM LEVEL gauge "E" indicator will illuminate or flash whenever power is applied to gauge.
- Foam level probe is designed and calibrated to detect class A foam. Substituting class A foam with other liquids will send a false signal to FOAM LEVEL gauge. If it is suspected that foam system has been contaminated or compromised with different brands and/or types of foam, drain foam tank (WP 0031) and fill with class A foam.

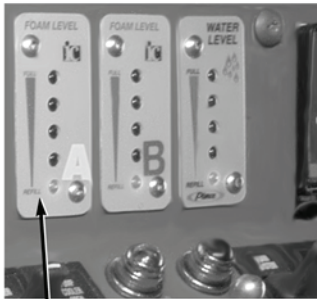
**MALFUNCTION****TEST OR INSPECTION****CORRECTIVE ACTION**

**CAB FOAM A  
LEVEL GAUGE**



**PUMP OPERATOR'S PANEL  
FOAM A LEVEL GAUGE**

- Step 1. Turn battery disconnect switch to ON position (WP 0007). Open pump operator's panel cover (WP 0019). Check if cab and pump operator's panel FOAM A LEVEL gauge indicators illuminate or flash (WP 0004).

If cab and pump operator's panel FOAM A LEVEL gauge indicators do not illuminate or flash, go to Step 9.

- Step 2. Check if only pump operator's panel FOAM A LEVEL gauge indicators illuminate or flash (WP 0004).

If cab FOAM A LEVEL gauge indicators do not illuminate or flash, go to Step 6.

- Step 3. With foam tank filled (WP 0031), check if cab and pump operator's panel FOAM A LEVEL gauges show equal readings (WP 0004).

If cab and pump operator's panel FOAM A LEVEL gauges do not show equal readings, go to Step 8.

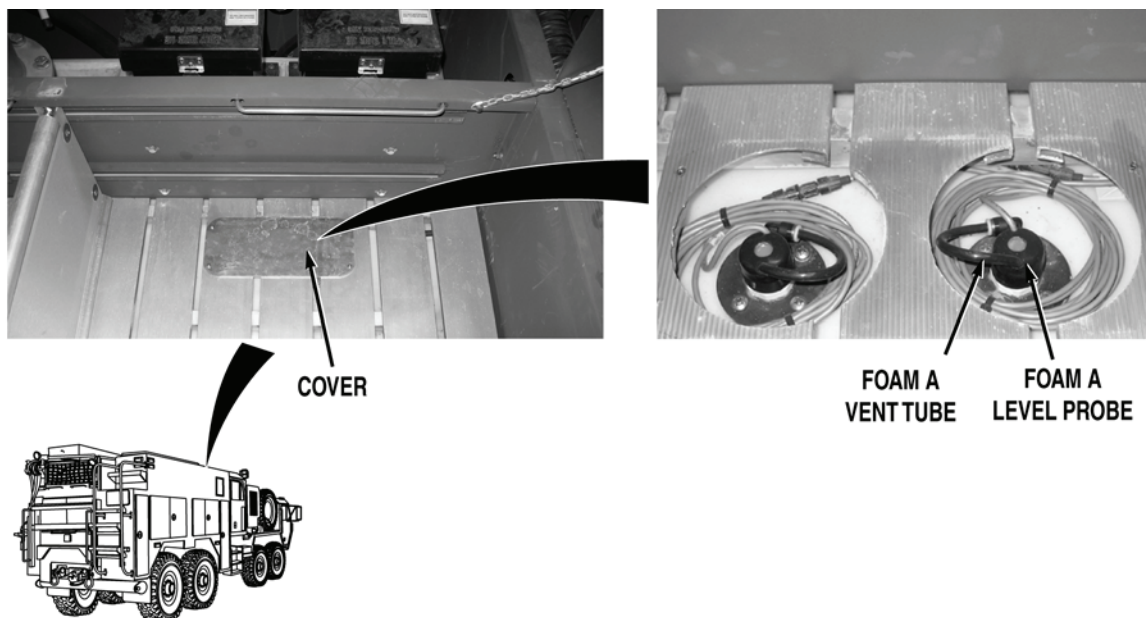
**MALFUNCTION****TEST OR INSPECTION****CORRECTIVE ACTION**

- Step 4. Open hose bed covers (WP 0015). Turn battery disconnect switch to OFF position (WP 0007). Remove foam tank level probe cover (WP 0281). Check foam A level probe vent tube for kinks, blockage, and damage.

If foam level probe vent tube is kinked, blocked, or damaged, remove blockage or replace foam level probe (WP 0281).

**WARNING**

**Remove rings, wristwatches, neck chains, and any other jewelry before working around vehicle. Jewelry can catch on equipment and cause serious injury. Jewelry and tools may short across electrical circuits and cause damage to equipment, or severe burns or electrical shock to personnel.**

- Step 5. Calibrate pump operator's panel foam A level gauge (WP 0191). Turn battery disconnect switch to ON position (WP 0007). Check if pump operator's panel FOAM A LEVEL gauge indicates correct foam level in tank after calibration of pump operator's panel foam level gauge has been performed.
- a. If pump operator's panel FOAM A LEVEL gauge indicates correct foam level in tank, fault corrected.
  - b. If pump operator's panel FOAM A LEVEL gauge does not indicate correct foam level in tank, replace foam level probe (WP 0281).

**MALFUNCTION**

**TEST OR INSPECTION**

**CORRECTIVE ACTION**

FOAM A LEVEL GAUGE  
WIRE HARNESS

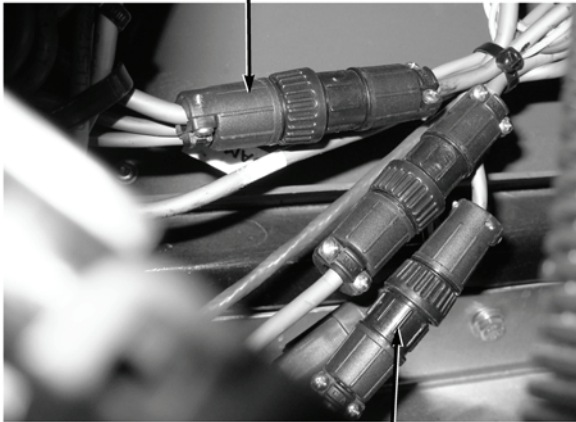

WATER LEVEL GAUGE  
WIRE HARNESS



**WARNING**



Remove rings, wristwatches, neck chains, and any other jewelry before working around vehicle. Jewelry can catch on equipment and cause serious injury. Jewelry and tools may short across electrical circuits and cause damage to equipment, or severe burns or electrical shock to personnel.

**NOTE**

Step 6 will isolate fault that may exist in FOAM A LEVEL gauge and wire harness leading to gauge, or will show if fault exists in pump operator's panel FOAM A LEVEL gauge.

- Step 6. Turn battery disconnect switch to OFF position (WP 0007). Open pump operator's panel housing (WP 0325). Disconnect cab water level gauge wire harness connector from pump operator's panel WATER LEVEL gauge. Disconnect cab foam level gauge wire harness connector from pump operator's panel FOAM A LEVEL gauge. Connect cab water level gauge wire harness connector to pump operator's panel FOAM A LEVEL gauge. Turn battery disconnect switch to ON position (WP 0007). Check if cab WATER LEVEL gauge illuminates (WP 0004).

If cab WATER LEVEL gauge does not illuminate, replace pump operator's panel FOAM A LEVEL gauge (WP 0322).



**MALFUNCTION**  
**TEST OR INSPECTION**  
**CORRECTIVE ACTION**

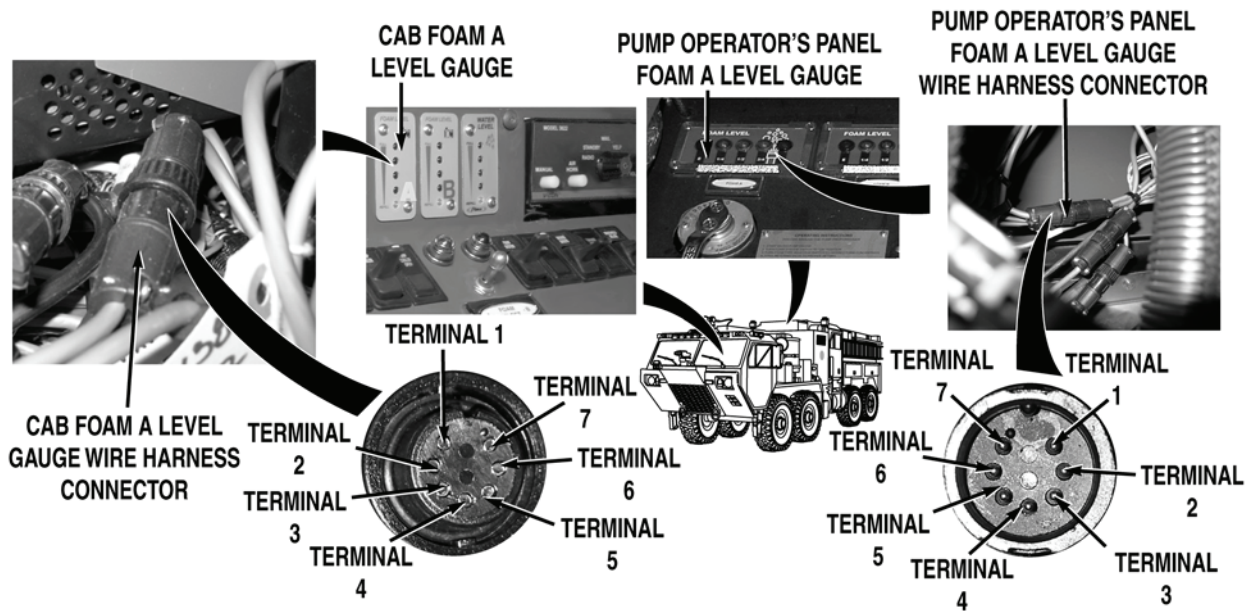

- Step 7. Turn battery disconnect switch to OFF position (WP 0007). Open pump operator's panel housing (WP 0325). Disconnect cab water level gauge wire harness connector from pump operator's panel FOAM A LEVEL gauge. Remove cab instrument panel A (WP 0311). Disconnect cab foam level gauge wire harness connector from cab FOAM A LEVEL gauge. With a test lead set, check for continuity across cab foam level gauge wire harness from pump operator's panel FOAM A LEVEL gauge connector, terminal 1 to cab FOAM A LEVEL gauge connector, terminal 1. Note reading. Repeat continuity checks for terminals 2 to 2, 3 to 3, 4 to 4, 5 to 5, 6 to 6, and 7 to 7.
- a. If there is continuity across all terminals of cab foam level gauge wire harness, replace cab FOAM A LEVEL gauge (WP 0316).
  - b. If there is no continuity for any pair of terminals, replace cab foam level gauge wire harness (WP 0439).

**MALFUNCTION**

**TEST OR INSPECTION**

**CORRECTIVE ACTION**

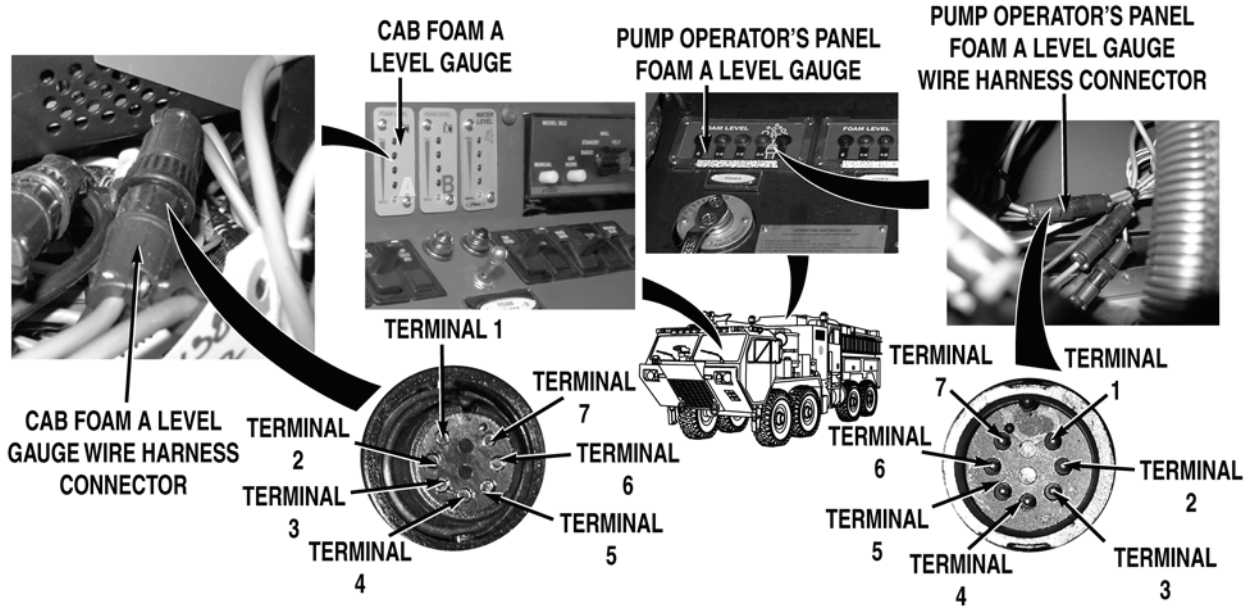

Step 8. Turn battery disconnect switch to OFF position (WP 0007). Open pump operator's panel housing (WP 0325). Disconnect cab foam level gauge wire harness connector from pump operator's panel FOAM LEVEL gauge. Remove cab instrument panel A (WP 0311). Disconnect cab foam level gauge wire harness connector from cab FOAM A LEVEL gauge. With a test lead set, check for continuity across cab foam level gauge wire harness from pump operator's panel FOAM LEVEL gauge connector, terminal 1 to cab FOAM LEVEL gauge connector, terminal 1. Note reading. Repeat continuity checks for terminals 2 to 2, 3 to 3, 4 to 4, 5 to 5, 6 to 6, and 7 to 7.

- a. If there is continuity across all terminals of cab foam level gauge wire harness, replace pump operator's panel FOAM A LEVEL gauge (WP 0322).
- b. If there is no continuity for any pair of terminals, replace cab foam level indicator wire harness (WP 0439).

Step 9. Check if pump operator's panel WATER LEVEL gauge indicators illuminate or flash (WP 0004).

If pump operator's panel WATER LEVEL gauge indicators do not illuminate or flash, go to Step 12.

## MALFUNCTION

## TEST OR INSPECTION

## CORRECTIVE ACTION



PUMP OPERATOR'S PANEL  
FOAM A LEVEL GAUGE



PUMP OPERATOR'S PANEL  
WIRE HARNESS FOAM A  
LEVEL GAUGE CONNECTOR



TERMINAL 1  
WIRE 2342

TERMINAL 2  
WIRE 3895

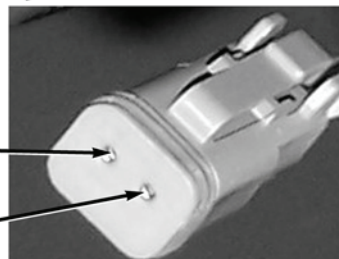
**WARNING**

Remove rings, wristwatches, neck chains, and any other jewelry before working around vehicle. Jewelry can catch on equipment and cause serious injury. Jewelry and tools may short across electrical circuits and cause damage to equipment, or severe burns or electrical shock to personnel.

- Step 10. Open pump operator's panel housing (WP 0325). Disconnect pump operator's panel wire harness FOAM A LEVEL gauge connector. With a test lead set, check for 22 to 28 VDC between wire 2342 (red) at pump operator's panel wire harness FOAM A LEVEL gauge connector, terminal 1 and a known good ground.

If 22 to 28 VDC are not present, repair wire 2342 in pump operator's panel wire harness if repairable (TM 9-2320-325-14&P), or replace pump operator's panel wire harness (WP 0459).

- Step 11. Turn battery disconnect switch to OFF position (WP 0007). With a test lead set, check for continuity across pump operator's panel wire harness wire 3895 (black) from pump operator's panel wire harness FOAM A LEVEL gauge connector, terminal 2 to a known good ground.
- If there is continuity, replace pump operator's panel FOAM A LEVEL gauge (WP 0322).
  - If there is no continuity, repair wire 3895 in pump operator's panel wire harness if repairable (TM 9-2320-325-14&P), or replace pump operator's panel wire harness (WP 0459).

---

**MALFUNCTION****TEST OR INSPECTION****CORRECTIVE ACTION**

---

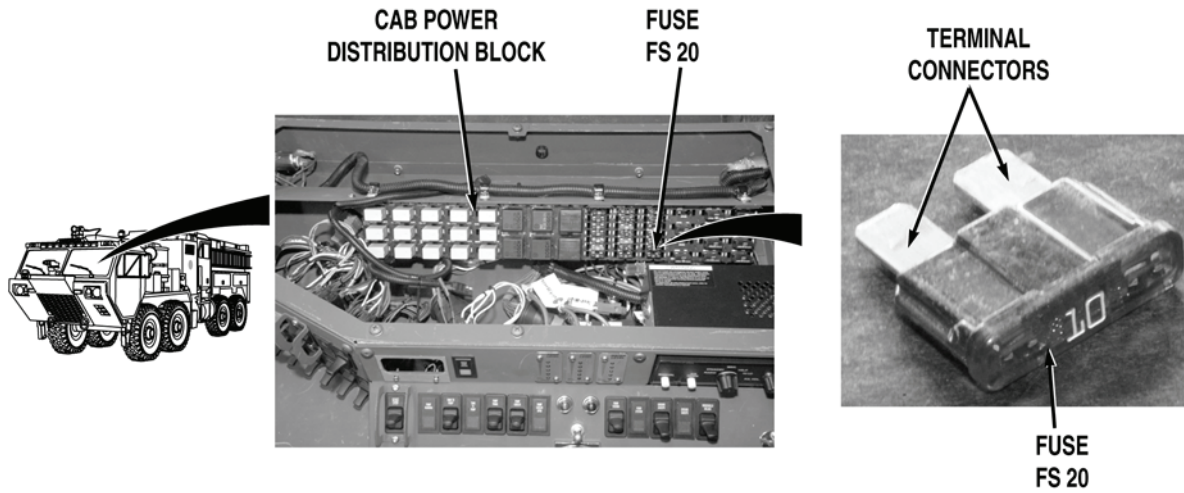

Step 12. Turn battery disconnect switch to OFF position (WP 0007). Remove cab instrument panel A (WP 0311). Remove fuse FS 20 (WP 0401). Check for continuity across fuse.

If there is no continuity, replace fuse FS 20 (WP 0401).

**MALFUNCTION****TEST OR INSPECTION****CORRECTIVE ACTION**

TERMINAL 4  
WIRE 2342

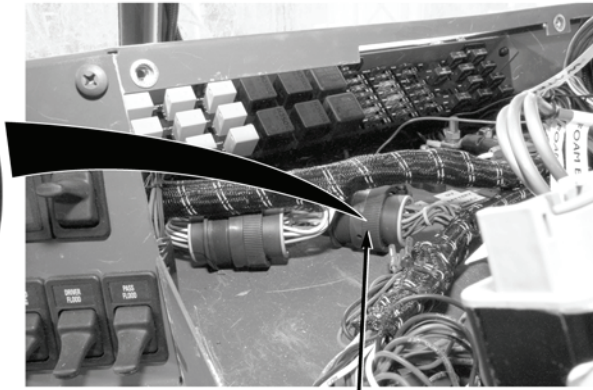

CAB PUMP CONTROL WIRE HARNESS  
CAB POWER DISTRIBUTION  
WIRE HARNESS CONNECTOR

**WARNING**

**Remove rings, wristwatches, neck chains, and any other jewelry before working around vehicle. Jewelry can catch on equipment and cause serious injury. Jewelry and tools may short across electrical circuits and cause damage to equipment, or severe burns or electrical shock to personnel.**

- Step 13. Install fuse FS 20 (WP 0401). Disconnect cab pump control wire harness cab power distribution wire harness connector. Turn battery disconnect switch to ON position (WP 0007). With a test lead set, check for 22 to 28 VDC between cab power distribution wire harness wire 2342 (red) at cab pump control wire harness cab power distribution wire harness connector, terminal 4 and a known good ground.

If 22 to 28 VDC are not present, repair wire 2342 in cab power distribution wire harness if repairable (TM 9-2320-325-14&P), or replace cab power distribution wire harness and block (WP 0441).

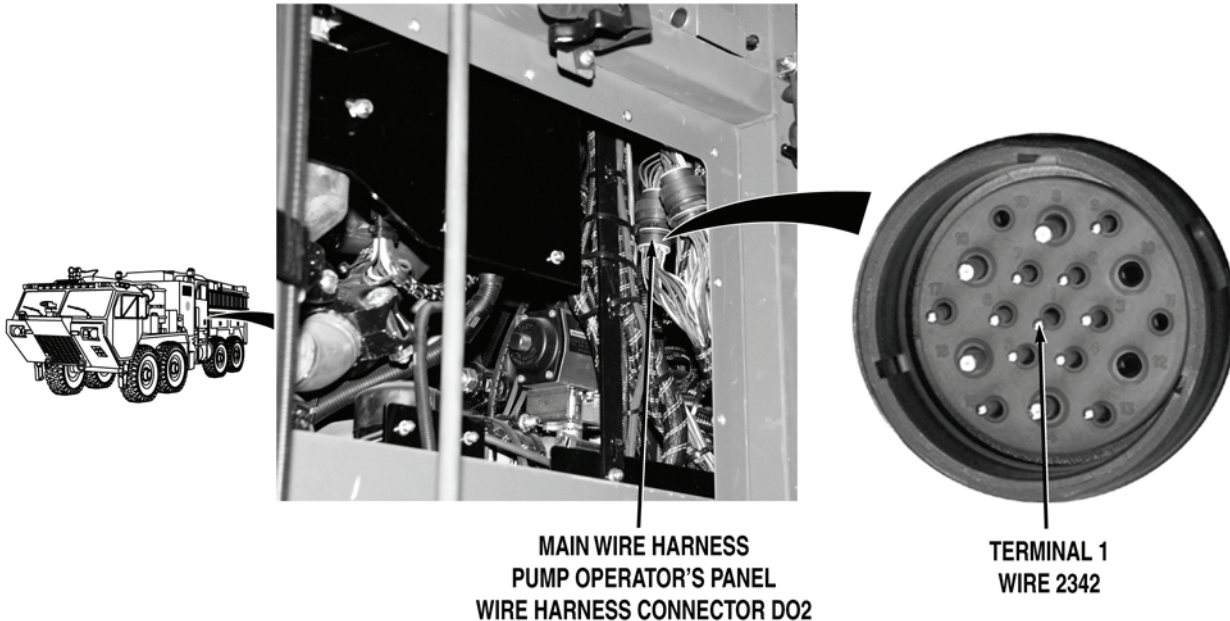
**MALFUNCTION****TEST OR INSPECTION****CORRECTIVE ACTION**

- Step 14. Connect cab pump control wire harness cab power distribution wire harness connector. Remove driver side crew cab access panel (WP 0499). Remove pump house panel Q (WP 0540). Disconnect main wire harness pump operator's panel wire harness connector DO2. With a test lead set, check for 22 to 28 VDC between main wire harness wire 2342 (red) at main wire harness pump operator's panel wire harness connector DO2, terminal 1 and a known good ground.

If 22 to 28 VDC are not present, go to Step 16.

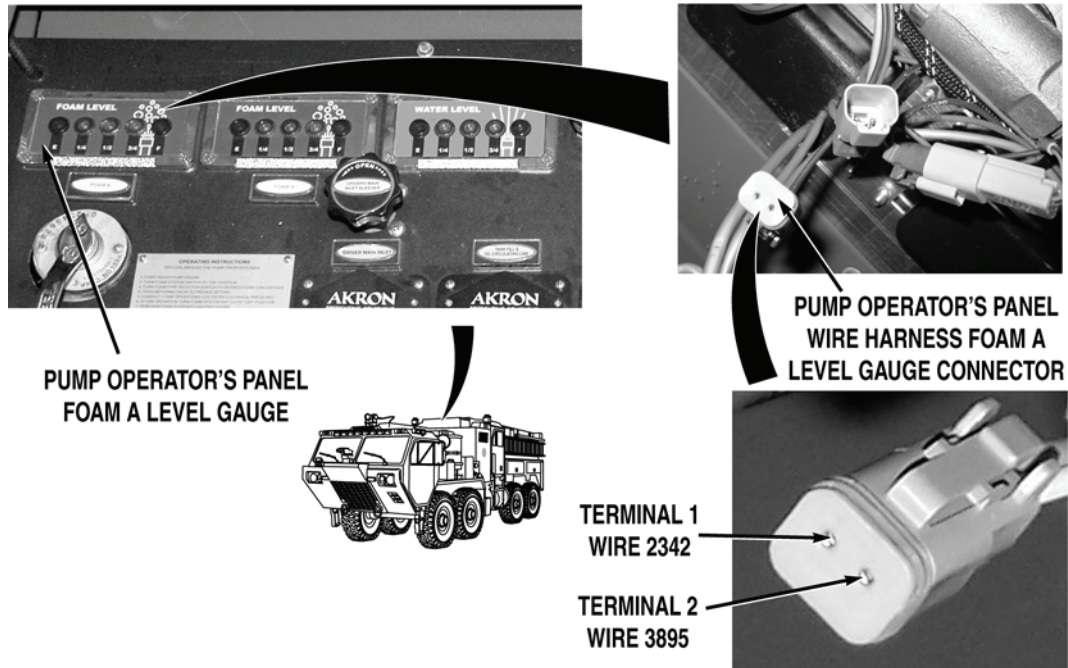
**MALFUNCTION****TEST OR INSPECTION****CORRECTIVE ACTION**

- Step 15. Turn battery disconnect switch to OFF position (WP 0007). Open pump operator's panel housing (WP 0325). Disconnect pump operator's panel wire harness FOAM A LEVEL gauge connector. With a test lead set, check for continuity across pump operator's panel wire harness wire 3895 (black) from pump operator's panel wire harness FOAM A LEVEL gauge connector, terminal 2 to a known good ground.
- a. If there is continuity, repair wire 2842 in pump operator's panel wire harness if repairable (TM 9-2320-325-14&P), or replace pump operator's panel wire harness (WP 0459).
  - b. If there is no continuity, repair wire 3895 in pump operator's panel wire harness if repairable (TM 9-2320-325-14&P), or replace pump operator's panel wire harness (WP 0459).

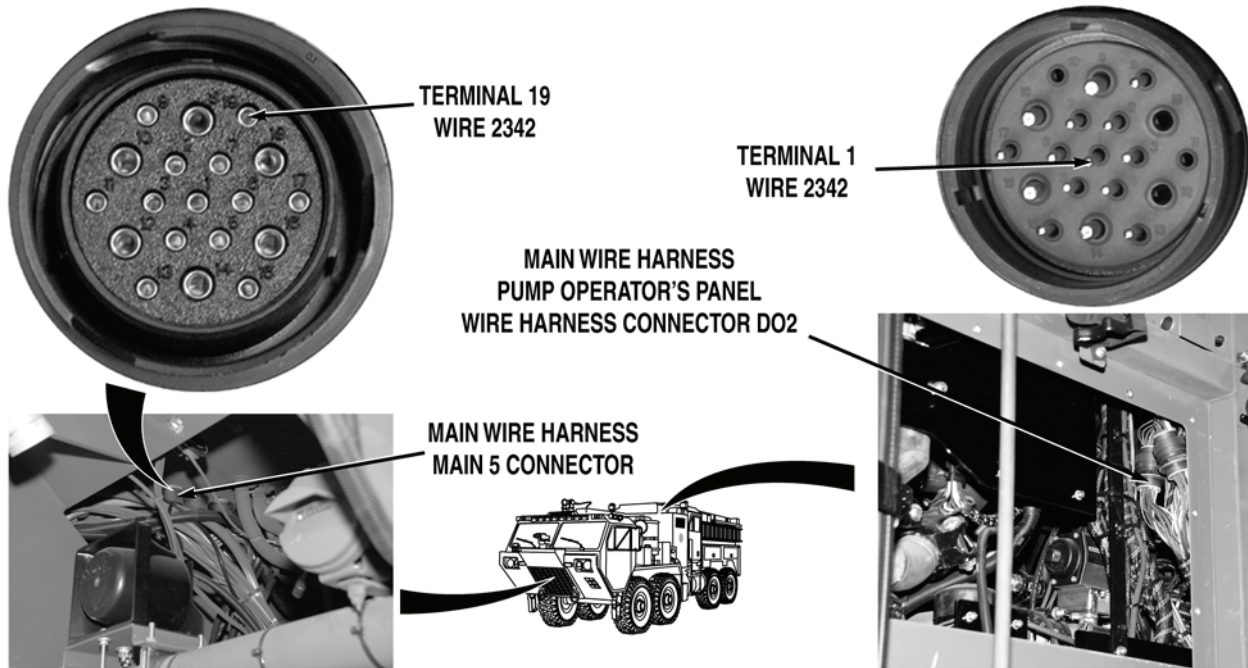
**MALFUNCTION****TEST OR INSPECTION****CORRECTIVE ACTION**

- Step 16. Remove skid plate grille (WP 0550). Turn battery disconnect switch to OFF position (WP 0007). Disconnect main wire harness main 5 connector. With a test lead set, check for continuity across main wire harness wire 2342 (red) from main wire harness main 5 connector, terminal 19 to main wire harness pump operator's panel wire harness connector DO2, terminal 1.
- a. If there is continuity, repair wire 2342 in cab pump control wire harness if repairable (TM 9-2320-325-14&P), or replace cab pump control wire harness (WP 0443).
  - b. If there is no continuity, repair wire 2342 in main wire harness if repairable (TM 9-2320-325-14&P), or replace main wire harness (WP 0455).

**END OF TASK****FOLLOW-ON MAINTENANCE**

Remove wheel chocks (TM 9-2320-347-10)

**END OF TASK****END OF WORK PACKAGE**



---

**FIELD LEVEL MAINTENANCE**
**FOAM B TANK LEVEL INDICATOR GAUGE DOES NOT OPERATE PROPERLY**

---

**INITIAL SETUP:****Tools and Special Tools**

Lead Set, Test (WP 0622, Item 21)  
 Tool Kit, General Mechanic's: Automotive  
 (WP 0622, Item 27)

**Personnel Required**

MOS 63B Wheeled vehicle mechanic (2)

**References**

TM 9-2320-325-14&P  
 WP 0004  
 WP 0007  
 WP 0019  
 WP 0031  
 WP 0191  
 WP 0281  
 WP 0311  
 WP 0316  
 WP 0322

**References (continued)**

WP 0325  
 WP 0401  
 WP 0439  
 WP 0441  
 WP 0443  
 WP 0455  
 WP 0459  
 WP 0499  
 WP 0540  
 WP 0550

**Equipment Conditions**

Water pump engine OFF (WP 0022)  
 Engine OFF (TM 9-2320-347-10)  
 Parking brake applied (TM 9-2320-347-10)  
 Wheels chocked (TM 9-2320-347-10)

---

**MALFUNCTION****TEST OR INSPECTION****CORRECTIVE ACTION**

---

**FOAM B TANK LEVEL INDICATOR GAUGE DOES NOT OPERATE PROPERLY****NOTE**

- FOAM LEVEL indicators operate as follows: "E" indicator will flash when the foam level in tank is below 1/4 full. Indicators "E" and "1/4" will illuminate when foam tank is 1/4 full. Indicators "E", "1/4", and "1/2" will illuminate when foam tank is 1/2 full. Indicators "E", "1/4", "1/2", and "3/4" will illuminate when foam tank is 3/4 full. And indicators "E", "1/4", "1/2", "3/4", and "FULL" will illuminate when foam tank is full.
- FOAM LEVEL gauge "E" indicator will illuminate or flash whenever power is applied to gauge.
- Foam level probe is designed and calibrated to detect class B foam. Substituting class B foam with other liquids will send a false signal to FOAM LEVEL gauge. If it is suspected that foam system has been contaminated or compromised with different brands and/or types of foam, drain foam tank (WP 0031) and fill with class B foam.

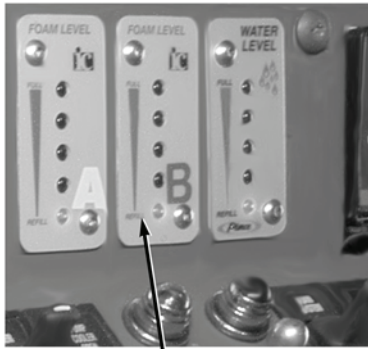
**MALFUNCTION****TEST OR INSPECTION****CORRECTIVE ACTION**

**CAB FOAM B  
LEVEL GAUGE**



**PUMP OPERATOR PANEL  
FOAM B LEVEL GAUGE**

- Step 1. Turn battery disconnect switch to ON position (WP 0007). Open pump operator's panel cover (WP 0019). Check if cab and pump operator's panel FOAM B LEVEL gauge indicators illuminate or flash (WP 0004).

If cab and pump operator's panel FOAM B LEVEL gauge indicators do not illuminate or flash, go to Step 9.

- Step 2. Check if only pump operator's panel FOAM B LEVEL gauge indicators illuminate or flash (WP 0004).

If cab FOAM B LEVEL gauge indicators do not illuminate or flash, go to Step 6.

- Step 3. With foam tank filled (WP 0031), check if cab and pump operator's panel FOAM B LEVEL gauges show equal readings (WP 0004).

If cab and pump operator's panel FOAM B LEVEL gauges do not show equal readings, go to Step 8.

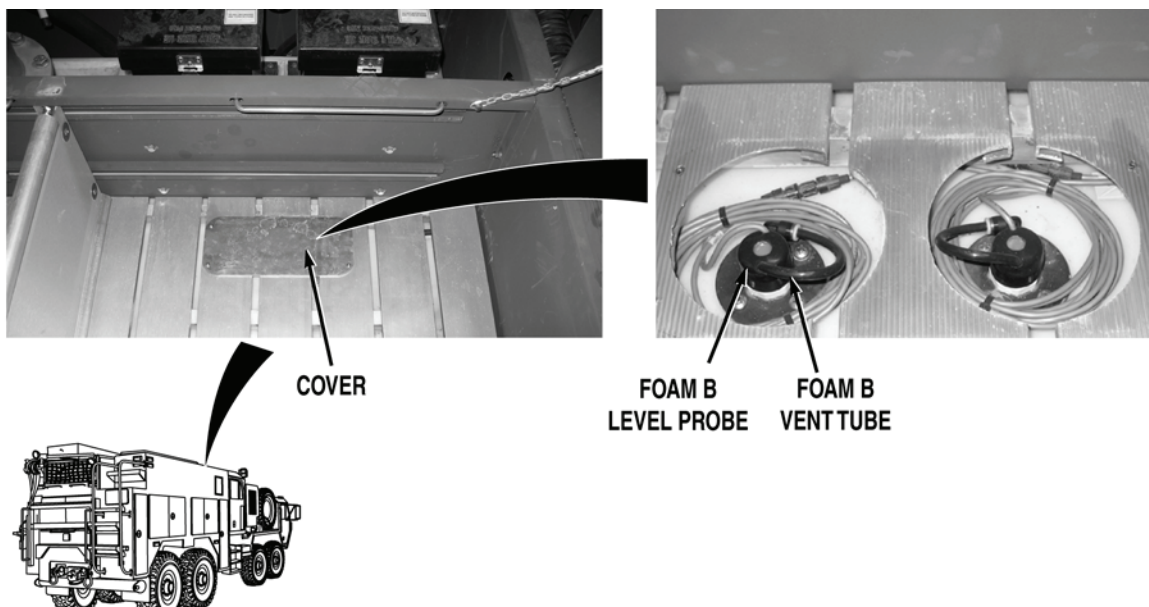
**MALFUNCTION****TEST OR INSPECTION****CORRECTIVE ACTION**

- Step 4. Open hose bed covers (WP 0015). Turn battery disconnect switch to OFF position (WP 0007). Remove foam tank level probe cover (WP 0281). Check foam level probe vent tube for kinks, blockage, and damage.

If foam level probe vent tube is kinked, blocked, or damaged, remove blockage or replace foam level probe (WP 0281).

**WARNING**

**Remove rings, wristwatches, neck chains, and any other jewelry before working around vehicle. Jewelry can catch on equipment and cause serious injury. Jewelry and tools may short across electrical circuits and cause damage to equipment, or severe burns or electrical shock to personnel.**

- Step 5. Calibrate pump operator's panel foam level gauge (WP 0191). Turn battery disconnect switch to ON position (WP 0007). Check if pump operator's panel FOAM B LEVEL gauge indicates correct foam level in tank after calibration of pump operator's panel foam level gauge has been performed.
- a. If pump operator's panel FOAM B LEVEL gauge indicates correct foam level in tank, fault corrected.
  - b. If pump operator's panel FOAM B LEVEL gauge does not indicate correct foam level in tank, replace foam level probe (WP 0281).

**MALFUNCTION****TEST OR INSPECTION****CORRECTIVE ACTION**

FOAM B LEVEL GAUGE  
WIRE HARNESS CONNECTOR

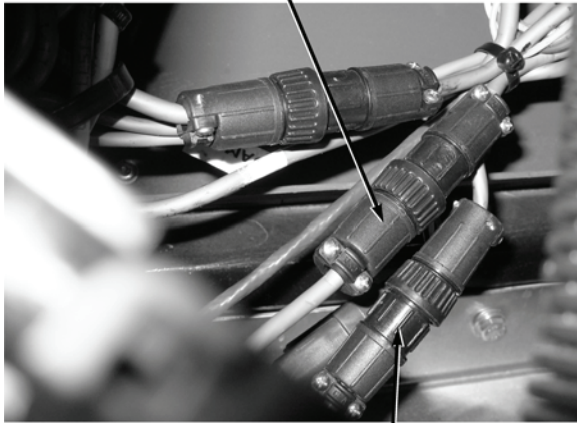

CAB WATER LEVEL GAUGE  
WIRE HARNESS CONNECTOR

**WARNING**

Remove rings, wristwatches, neck chains, and any other jewelry before working around vehicle. Jewelry can catch on equipment and cause serious injury. Jewelry and tools may short across electrical circuits and cause damage to equipment, or severe burns or electrical shock to personnel.

**NOTE**

Step 6 will isolate fault that may exist in cab FOAM B LEVEL gauge and wire harness leading to gauge, or will show if fault exists in pump operator's panel FOAM B LEVEL gauge.

- Step 6. Turn battery disconnect switch to OFF position (WP 0007). Open pump operator's panel housing (WP 0325). Disconnect cab water level gauge wire harness connector from pump operator's panel WATER LEVEL gauge. Disconnect cab foam level gauge wire harness connector from pump operator's panel FOAM B LEVEL gauge. Connect cab water level gauge wire harness connector to pump operator's panel FOAM B LEVEL gauge. Turn battery disconnect switch to ON position (WP 0007). Check if cab WATER LEVEL gauge illuminates (WP 0004).

If cab WATER LEVEL gauge does not illuminate, replace pump operator's panel FOAM B LEVEL gauge (WP 0322).

**MALFUNCTION**

**TEST OR INSPECTION**

**CORRECTIVE ACTION**

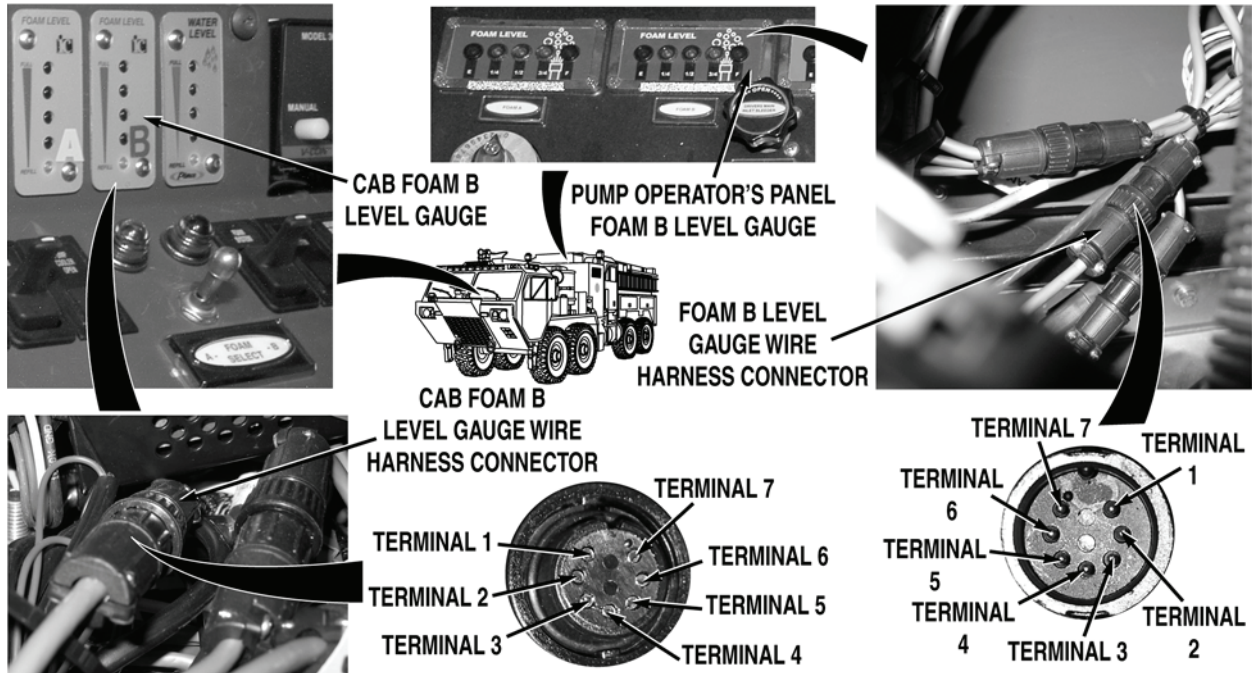

- Step 7. Turn battery disconnect switch to OFF position (WP 0007). Open pump operator's panel housing (WP 0325). Disconnect cab water level gauge wire harness connector from pump operator's panel FOAM B LEVEL gauge. Remove cab instrument panel A (WP 0311). Disconnect cab foam level gauge wire harness connector from cab FOAM B LEVEL gauge. With a test lead set, check for continuity across cab foam level gauge wire harness from pump operator's panel FOAM B LEVEL gauge connector, terminal 1 to cab FOAM B LEVEL gauge connector, terminal 1. Note reading. Repeat continuity checks for terminals 2 to 2, 3 to 3, 4 to 4, 5 to 5, 6 to 6, and 7 to 7.
- a. If there is continuity across all terminals of cab foam level gauge wire harness, replace cab FOAM B LEVEL gauge (WP 0316).
  - b. If there is no continuity for any pair of terminals, replace cab foam level gauge wire harness (WP 0439).

**MALFUNCTION**

**TEST OR INSPECTION**

**CORRECTIVE ACTION**

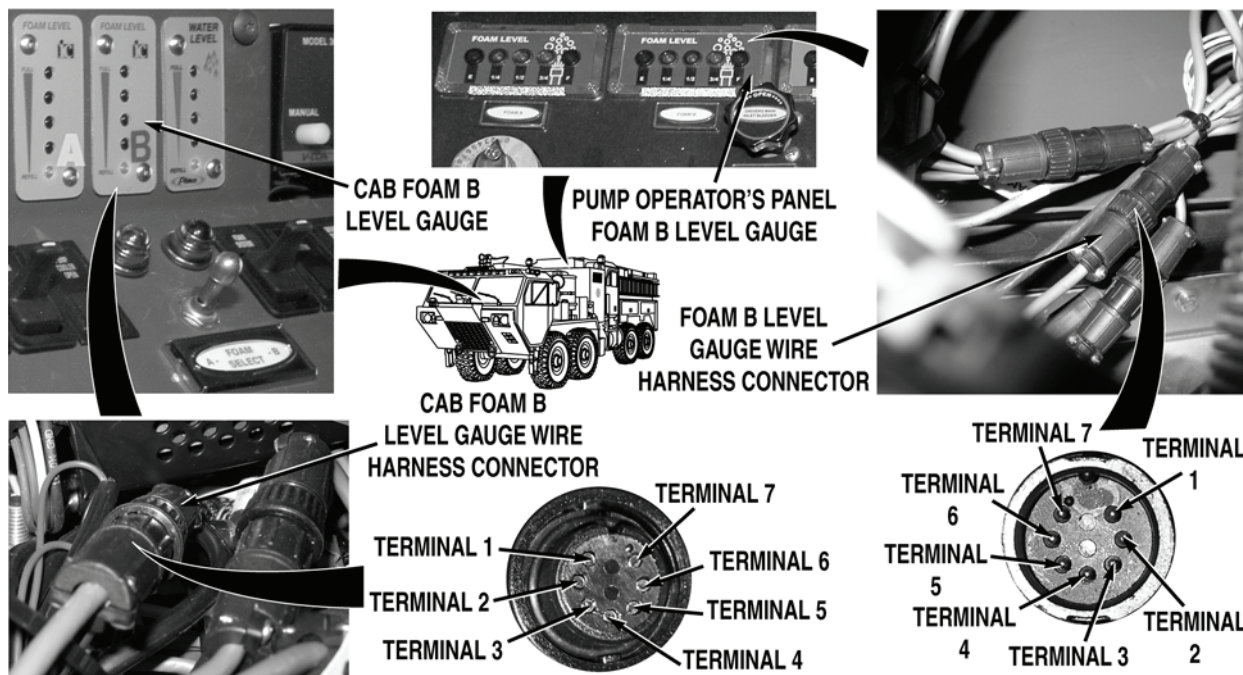

- Step 8. Turn battery disconnect switch to OFF position (WP 0007). Open pump operator's panel housing (WP 0325). Disconnect cab foam level gauge wire harness connector from pump operator's panel FOAM B LEVEL gauge. Remove cab instrument panel A (WP 0311). Disconnect cab foam level gauge wire harness connector from cab FOAM B LEVEL gauge. With a test lead set, check for continuity across cab foam level gauge wire harness from pump operator's panel FOAM B LEVEL gauge connector, terminal 1 to cab FOAM B LEVEL gauge connector, terminal 1. Note reading. Repeat continuity checks for terminals 2 to 2, 3 to 3, 4 to 4, 5 to 5, 6 to 6, and 7 to 7.
- a. If there is continuity across all terminals of cab foam level gauge wire harness, replace pump operator's panel FOAM B LEVEL gauge (WP 0322).
  - b. If there is no continuity for any pair of terminals, replace cab foam level gauge wire harness (WP 0439).
- Step 9. Check if pump operator's panel WATER LEVEL gauge indicators illuminate or flash (WP 0004).
- If pump operator's panel WATER LEVEL gauge indicators do not illuminate or flash, go to Step 12.

## MALFUNCTION

## TEST OR INSPECTION

## CORRECTIVE ACTION

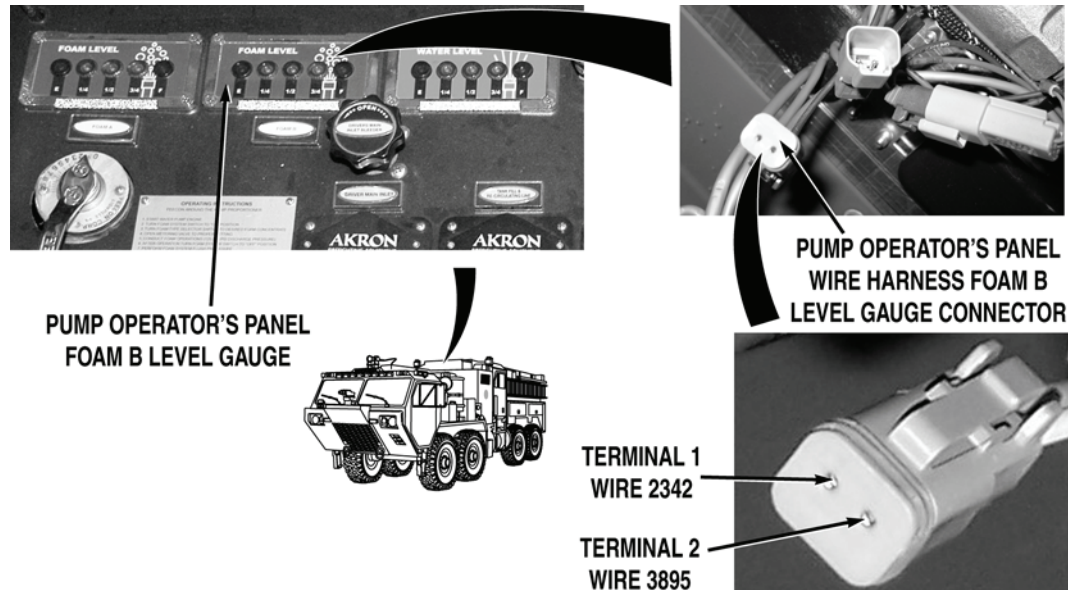
**WARNING**

Remove rings, wristwatches, neck chains, and any other jewelry before working around vehicle. Jewelry can catch on equipment and cause serious injury. Jewelry and tools may short across electrical circuits and cause damage to equipment, or severe burns or electrical shock to personnel.

- Step 10. Open pump operator's panel housing (WP 0325). Disconnect pump operator's panel wire harness FOAM B LEVEL gauge connector. With a test lead set, check for 22 to 28 VDC between wire 2342 (red) at pump operator's panel wire harness FOAM B LEVEL gauge connector, terminal 1 and a known good ground.

If 22 to 28 VDC are not present, repair wire 2342 in pump operator's panel wire harness if repairable (TM 9-2320-325-14&P), or replace pump operator's panel wire harness (WP 0459).

- Step 11. Turn battery disconnect switch to OFF position (WP 0007). With a test lead set, check for continuity across pump operator's panel wire harness wire 3895 (black) from pump operator's panel wire harness FOAM B LEVEL gauge connector, terminal 2 to a known good ground.
- a. If there is continuity, replace pump operator's panel FOAM B LEVEL gauge (WP 0322).
  - b. If there is no continuity, repair wire 3895 in pump operator's panel wire harness if repairable (TM 9-2320-325-14&P), or replace pump operator's panel wire harness (WP 0459).

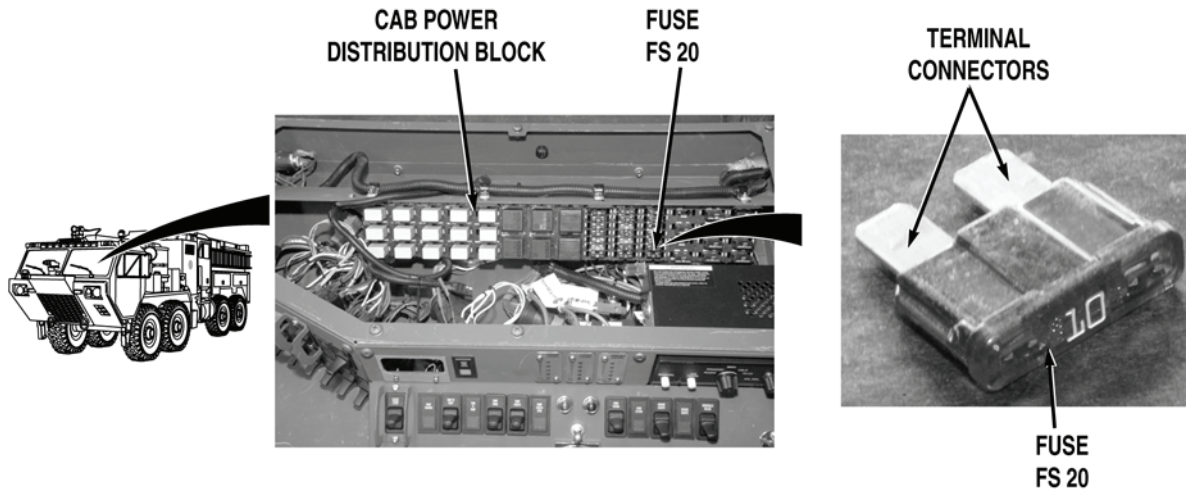
**MALFUNCTION****TEST OR INSPECTION****CORRECTIVE ACTION****WARNING**

Remove rings, wristwatches, neck chains, and any other jewelry before working around vehicle. Jewelry can catch on equipment and cause serious injury. Jewelry and tools may short across electrical circuits and cause damage to equipment, or severe burns or electrical shock to personnel.

Step 12. Turn battery disconnect switch to OFF position (WP 0007). Remove cab instrument panel A (WP 0311). Remove fuse FS 20 (WP 0401). Check for continuity across fuse.

If there is no continuity, replace fuse FS 20 (WP 0401).



**MALFUNCTION****TEST OR INSPECTION****CORRECTIVE ACTION**

TERMINAL 4  
WIRE 2342

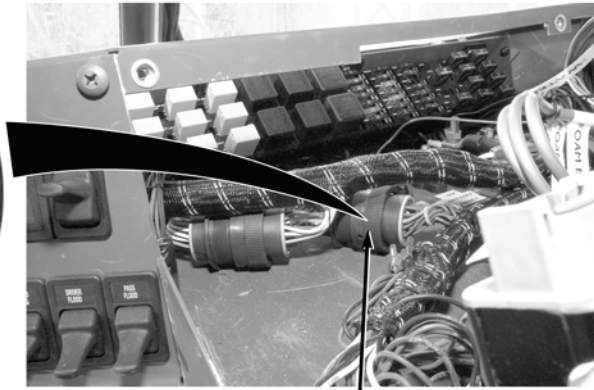

CAB PUMP CONTROL WIRE HARNESS  
CAB POWER DISTRIBUTION  
WIRE HARNESS CONNECTOR



- Step 13. Install fuse FS 20 (WP 0401). Disconnect cab pump control wire harness cab power distribution wire harness connector. Turn battery disconnect switch to ON position (WP 0007). With a test lead set, check for 22 to 28 VDC between cab power distribution wire harness wire 2342 (red) at cab pump control wire harness cab power distribution wire harness connector, terminal 4 and a known good ground.

If 22 to 28 VDC are not present, repair wire 2342 in cab power distribution wire harness if repairable (TM 9-2320-325-14&P), or replace cab power distribution wire harness and block (WP 0441).

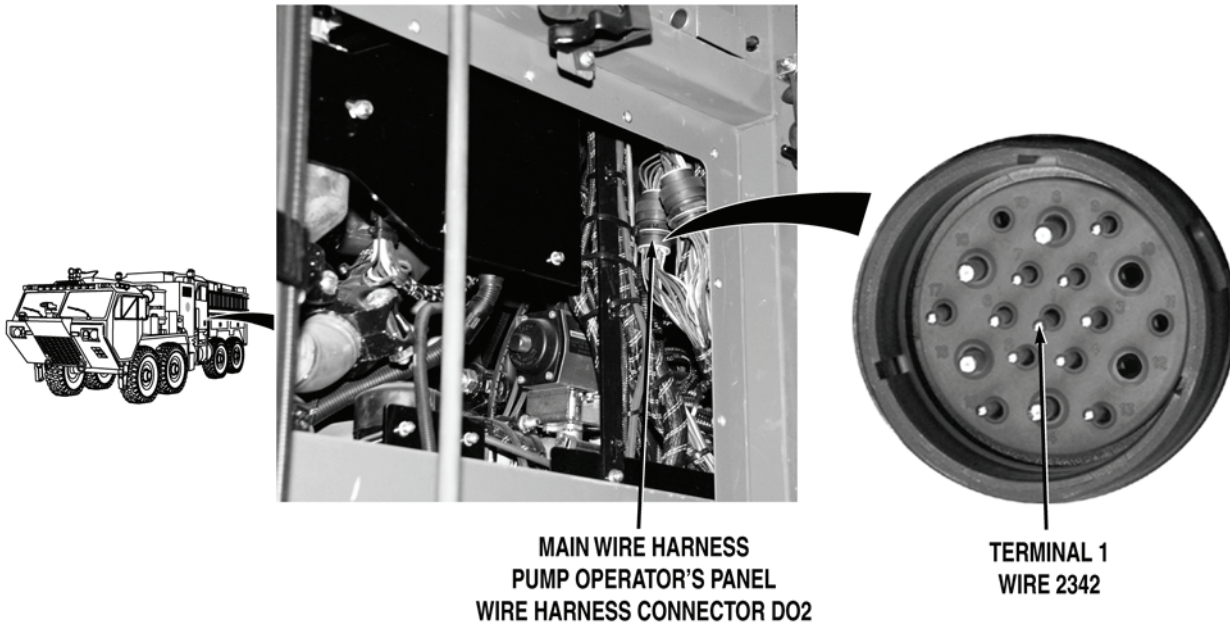
**MALFUNCTION****TEST OR INSPECTION****CORRECTIVE ACTION**

- Step 14. Connect cab pump control wire harness cab power distribution wire harness connector. Remove driver side crew cab access panel (WP 0499). Remove pump house panel Q (WP 0540). Disconnect main wire harness pump operator's panel wire harness connector D02. With a test lead set, check for 22 to 28 VDC between main wire harness wire 2342 (red) at main wire harness pump operator's panel wire harness connector D02, terminal 1 and a known good ground.

If 22 to 28 VDC are not present, go to Step 16.

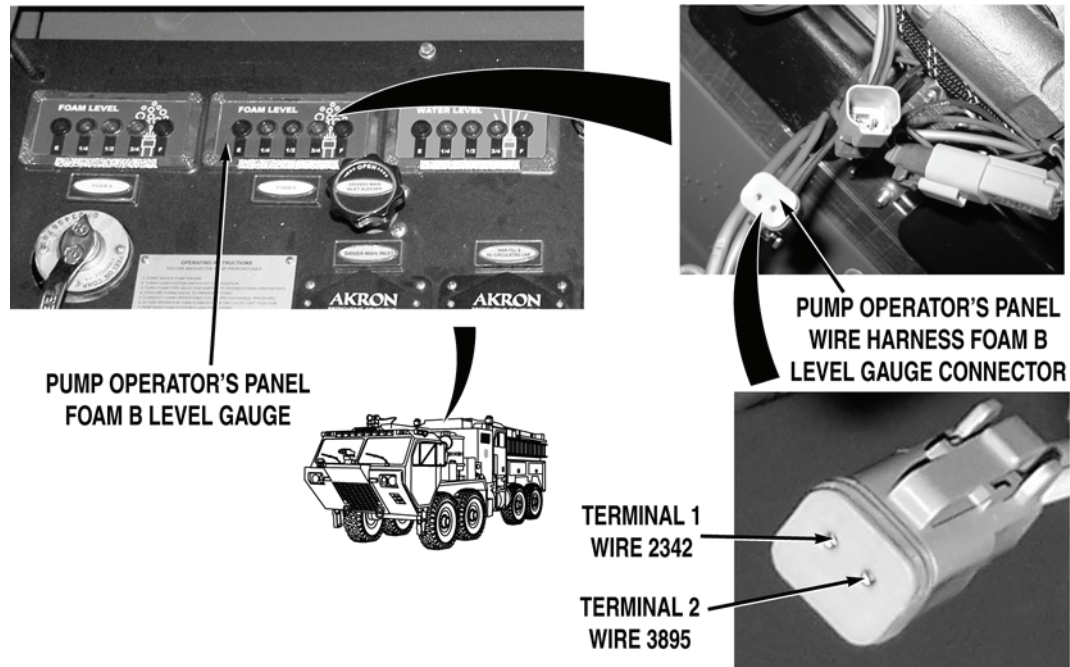
**MALFUNCTION****TEST OR INSPECTION****CORRECTIVE ACTION**

- Step 15. Turn battery disconnect switch to OFF position (WP 0007). Open pump operator's panel housing (WP 0325). Disconnect pump operator's panel wire harness FOAM B LEVEL gauge connector. With a test lead set, check for continuity across pump operator's panel wire harness wire 3895 (black) from pump operator's panel wire harness FOAM B LEVEL gauge connector, terminal 2 to a known good ground.
- a. If there is continuity, repair wire 2342 in pump operator's panel wire harness if repairable (TM 9-2320-325-14&P), or replace pump operator's panel wire harness (WP 0459).
  - b. If there is no continuity, repair wire 3895 in pump operator's panel wire harness if repairable (TM 9-2320-325-14&P), or replace pump operator's panel wire harness (WP 0459).

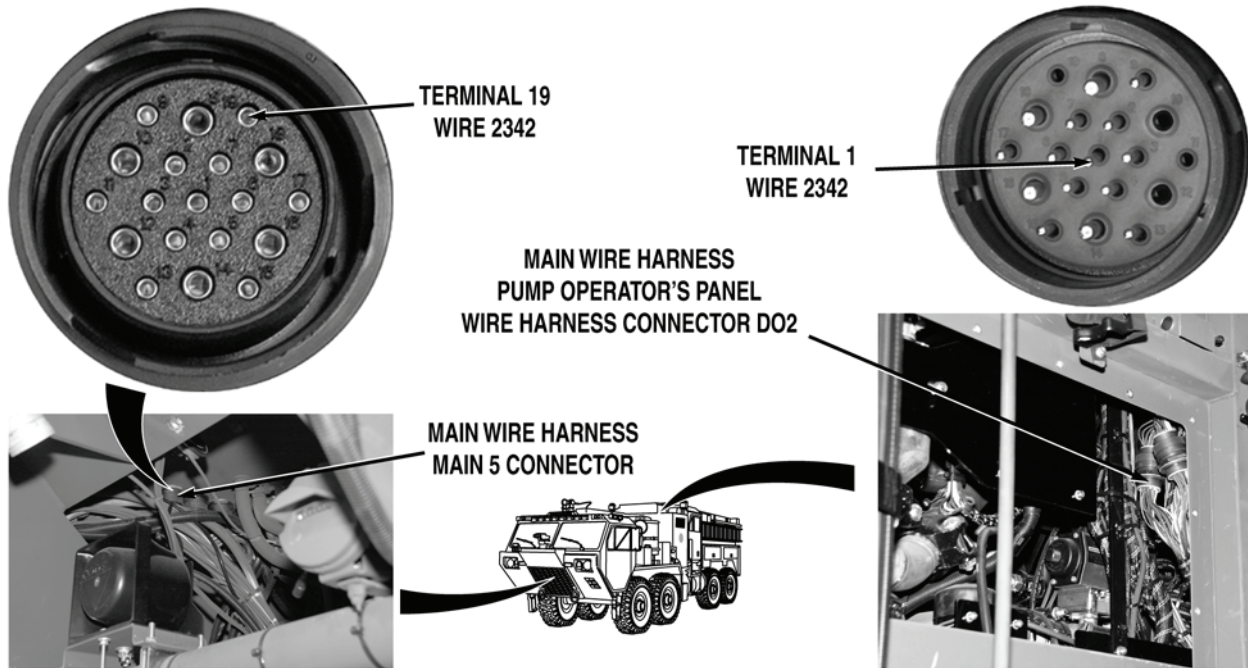
**MALFUNCTION****TEST OR INSPECTION****CORRECTIVE ACTION**

- Step 16. Remove skid plate grille (WP 0550). Turn battery disconnect switch to OFF position (WP 0007). Disconnect main wire harness main 5 connector. With a test lead set, check for continuity across main wire harness wire 2342 (red) from main wire harness main 5 connector, terminal 19 to main wire harness pump operator's panel wire harness connector D02, terminal 1.
- a. If there is continuity, repair wire 2342 in cab pump control wire harness if repairable (TM 9-2320-325-14&P), or replace cab pump control wire harness (WP 0443).
  - b. If there is no continuity, repair wire 2342 in main wire harness if repairable (TM 9-2320-325-14&P), or replace main wire harness (WP 0455).

**END OF TASK****FOLLOW-ON MAINTENANCE**

Remove wheel chocks (TM 9-2320-347-10)

**END OF TASK****END OF WORK PACKAGE**

---

**FIELD LEVEL MAINTENANCE**
**BUMPER TURRET DOES NOT OPERATE PROPERLY WHEN SELECTED**

---

**INITIAL SETUP:****Tools and Special Tools**

Lead Set, Test (WP 0622, Item 21)  
 Tool Kit, General Mechanic's: Automotive  
 (WP 0622, Item 27)

**Personnel Required**

MOS 63B Wheeled vehicle mechanic (2)

**References**

TM 9-2320-325-14&P  
 WP 0004  
 WP 0007  
 WP 0031  
 WP 0035  
 WP 0188  
 WP 0311  
 WP 0370  
 WP 0401  
 WP 0440  
 WP 0441

**References (continued)**

WP 0437  
 WP 0442  
 WP 0443  
 WP 0455  
 WP 0459  
 WP 0482  
 WP 0499  
 WP 0539  
 WP 0540  
 WP 0550  
 WP 0567  
 WP 0569  
 WP 0570  
 WP 0571  
 WP 0572  
 WP 0573

**Equipment Conditions**

Water pump engine OFF (WP 0022)  
 Engine OFF (TM 9-2320-347-10)  
 Wheels chocked (TM 9-2320-347-10)

---

**MALFUNCTION****TEST OR INSPECTION****CORRECTIVE ACTION**

---

**BUMPER TURRET DOES NOT OPERATE PROPERLY WHEN SELECTED**

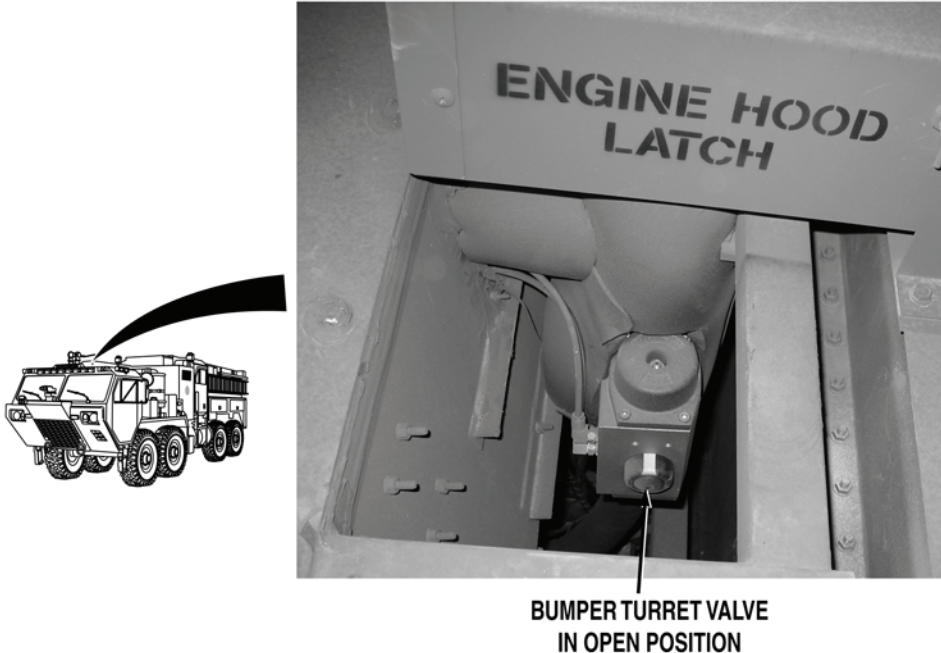
**MALFUNCTION****TEST OR INSPECTION****CORRECTIVE ACTION****NOTE**

- Ensure system air pressure is at least 85 psi (586 kPa) during this procedure. System air pressure is required to activate valves.
- Do not engage water pump engine during this procedure, except when performing complete system checks. Valve operations can be checked without water pump operation.
- Valve operations can be checked by observing valve shaft rotation. Valves are open when tabs or yellow paint tabs are aligned with fluid flow.

Step 1. If system air pressure is below 85 psi (586 kPa), start engine and allow system air pressure to build to at least 85 psi (586 kPa) (TM 9-2320-347-10). Then shut off engine (TM 9-2320-347-10). Turn battery disconnect switch to ON position (WP 0007). Put bumper turret control POWER switch to | (on) position (WP 0004). While an assistant pushes bumper turret control discharge switch (WP 0004), check if bumper turret valve operates to open position.

If bumper turret valve operates to open position, go to Step 15.

---

**MALFUNCTION**  
**TEST OR INSPECTION**  
**CORRECTIVE ACTION**

---

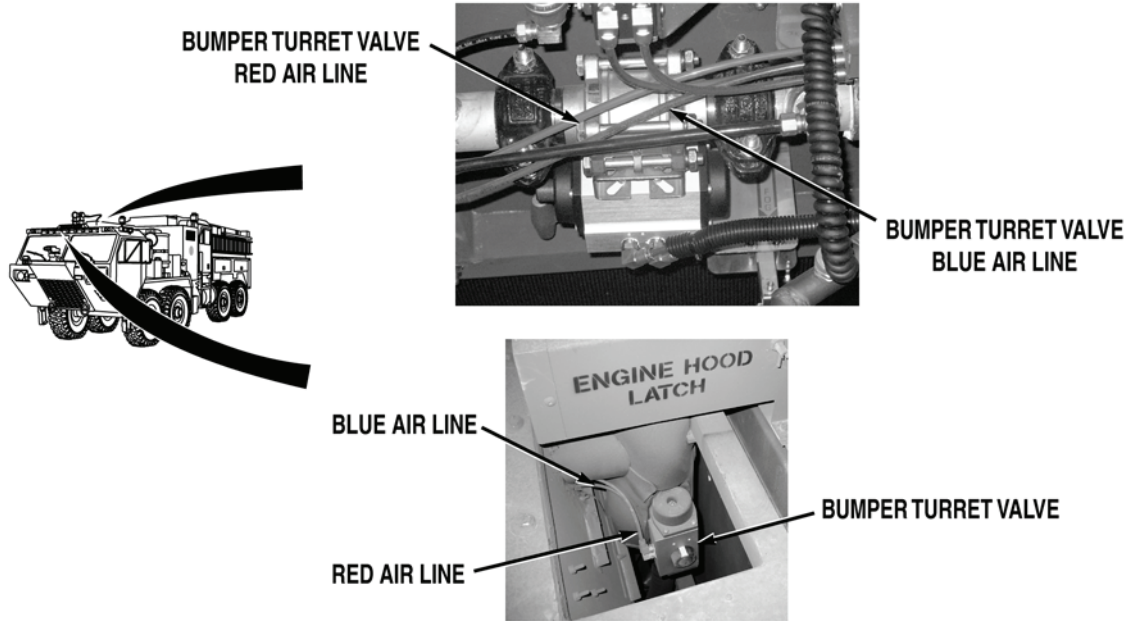

Step 2. Inspect red and blue air lines from bumper turret valve control to bumper turret valve for leaks, kinks, or damage.

If air lines are not free from leaks, kinks or damage, replace damaged air lines (WP 0567).

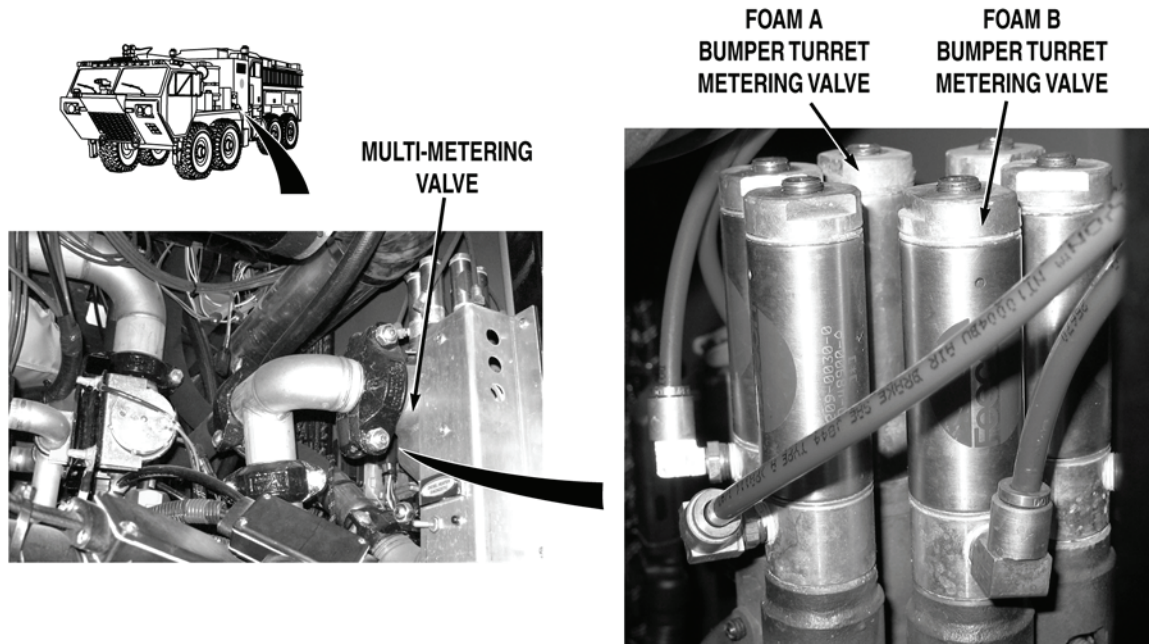
**MALFUNCTION****TEST OR INSPECTION****CORRECTIVE ACTION****NOTE**

Test should be done using both Foam A and Foam B separately. Operation of cylinder can be checked by listening for metallic click.

- Step 3. Release bumper turret control discharge switch (WP 0004). Open pump house panel A (WP 0539). Put FOAM SYSTEM switch to ON position. Put FOAM TANK switch to "A" or "B" position. While an assistant pushes bumper turret control discharge switch (WP 0004). Check if bumper turret foam A or B multi-metering valve cylinder operates to open position. Flush foam system (WP 0031).

If bumper turret A or B foam multi-metering valve cylinder does not operate to open position, go to Step 7.

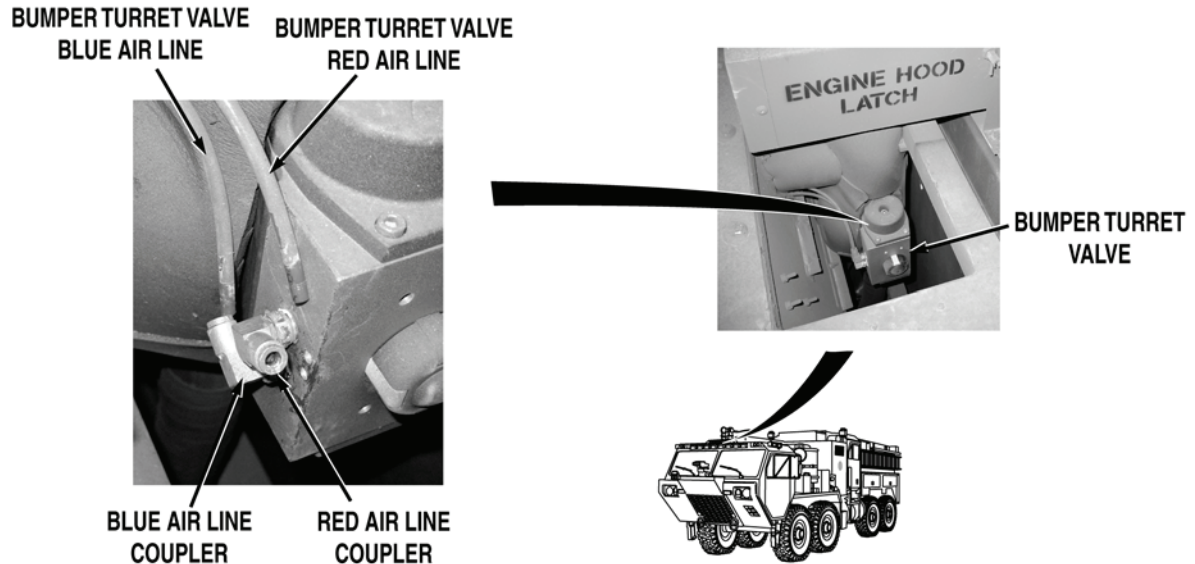

**MALFUNCTION****TEST OR INSPECTION****CORRECTIVE ACTION****WARNING**

- If air lines are under pressure when they are disconnected, they can whip around and cause injury to personnel. Caution should be exercised when disconnecting air line fittings.
- Air lines may be under pressure when control valve is operated. If under pressure and air lines are disconnected, air lines may whip around and cause injury to personnel. Caution should be exercised when operating control valve with air lines disconnected.

**NOTE**

Air pressure is checked by disconnecting air lines at bumper turret valve and observing air pressure escaping from air lines, when bumper turret valve is activated. Air will escape from blue air line when bumper turret control discharge switch is pressed, and escape from red air line when bumper turret control discharge switch is released. System air pressure may drop below 85 psi (586 kPa) during this procedure.

- Step 4. Release bumper turret control discharge switch (WP 0004). Disconnect air lines at bumper turret valve. While an assistant pushes bumper turret control discharge switch, check if air pressure is present at bumper turret valve.

If there is air pressure, replace bumper turret valve (WP 0482).

## MALFUNCTION

## TEST OR INSPECTION

## CORRECTIVE ACTION

ROOF, BUMPER, AND PUMP COOLER  
JUNCTION BOX

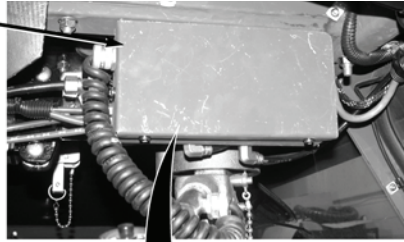
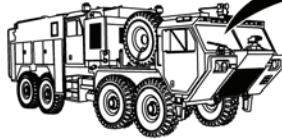

TERMINAL  
WIRE 1640 (BLACK)

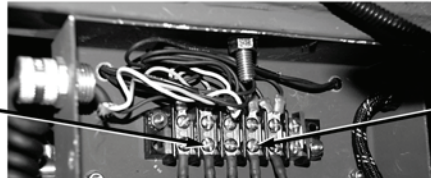

TERMINAL  
WIRE 2837 (GRAY)

**WARNING**

**Remove rings, wristwatches, neck chains, and any other jewelry before working around vehicle. Jewelry can catch on equipment and cause serious injury. Jewelry and tools may short across electrical circuits and cause damage to equipment, or severe burns or electrical shock to personnel.**

- Step 5. Connect air lines at bumper turret valve. Turn battery disconnect to OFF position (WP 0007). Remove roof, bumper, and pump cooler junction box cover (WP 0423). Turn battery disconnect switch to ON position (WP 0007). Push cab bumper turret discharge switch (WP 0004). Check for 22 to 28 VDC between cab roof wire harness wire 2837 (gray) at roof, bumper, pump cooler junction box control terminal strip and a known good ground.

If 22 to 28 VDC are not present, repair wire 2837 in cab roof wire harness if repairable (TM 9-2320-325-14&P), or replace cab roof wire harness (WP 0442).

- Step 6. Release bumper turret discharge switch (WP 0035). Put bumper turret control POWER switch to  $\bigcirc$  (off) position (WP 0035). Turn battery disconnect switch to OFF position (WP 0007). Check for continuity across cab roof wire harness wire 1640 (black) from roof, bumper, and pump cooler junction box control terminal strip to a known good ground.
- a. If there is continuity, replace bumper turret control valve (WP 0370).
  - b. If there is no continuity, repair wire 1640 in cab roof wire harness if repairable (TM 9-2320-325-14&P), or replace cab roof wire harness (WP 0442).

**MALFUNCTION**  
**TEST OR INSPECTION**  
**CORRECTIVE ACTION**

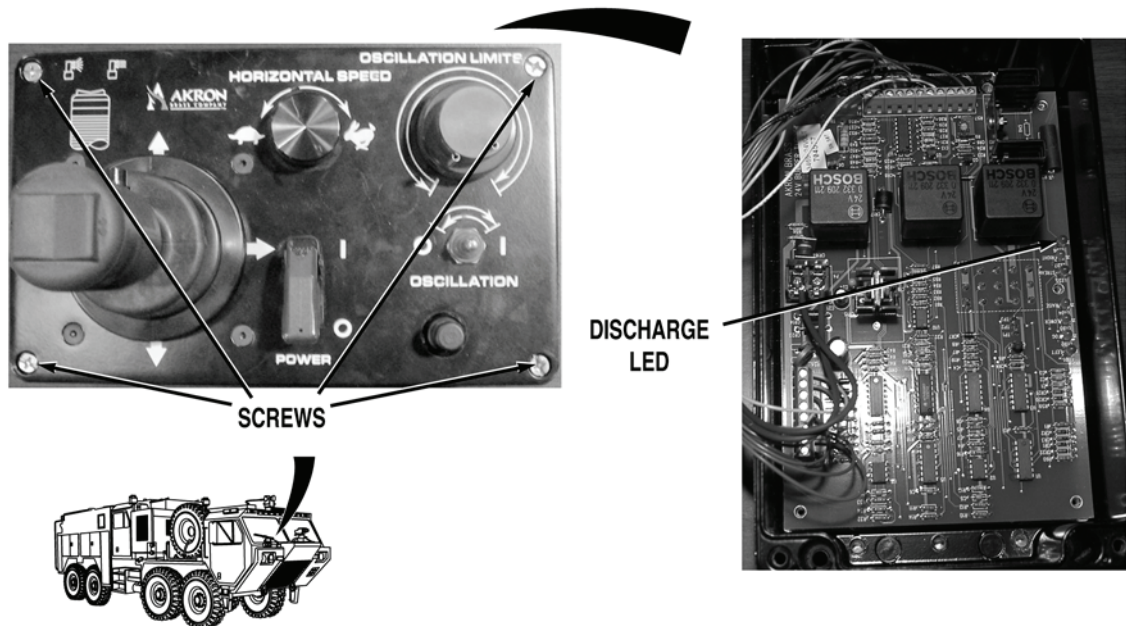

**WARNING**



**Remove rings, wristwatches, neck chains, and any other jewelry before working around vehicle. Jewelry can catch on equipment and cause serious injury. Jewelry and tools may short across electrical circuits and cause damage to equipment, or severe burns or electrical shock to personnel.**

- Step 7. Release bumper turret control discharge switch (WP 0004). Loosen four screws and remove bumper turret control cover. Do not disconnect wires. While pushing bumper turret control discharge switch (WP 0004), check if bumper turret control DISCHARGE LED illuminates.

If bumper turret control DISCHARGE LED illuminates, go to Step 12.

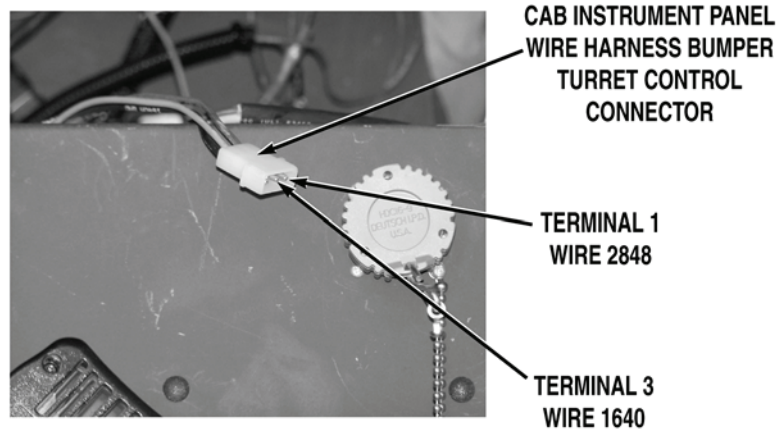
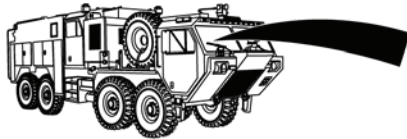
**MALFUNCTION****TEST OR INSPECTION****CORRECTIVE ACTION****WARNING**

**Remove rings, wristwatches, neck chains, and any other jewelry before working around vehicle. Jewelry can catch on equipment and cause serious injury. Jewelry and tools may short across electrical circuits and cause damage to equipment, or severe burns or electrical shock to personnel.**

- Step 8. Release bumper turret control discharge switch (WP 0004). Put bumper turret control POWER switch to  $\bigcirc$  (off) position (WP 0004). Turn battery disconnect switch to OFF position (WP 0007). Install bumper turret control cover and tighten four screws. Remove cab instrument panel E (WP 0311). Disconnect cab instrument panel wire harness bumper turret control connector. Check for continuity across cab instrument panel wire harness wire 1640 (black) from cab instrument panel wire harness bumper turret control connector, terminal 3 to a known good ground.

If there is no continuity, repair wire 1640 in cab instrument panel wire harness if repairable (TM 9-2320-325-14&P), or replace cab instrument panel wire harness (WP 0440).

- Step 9. Turn battery disconnect switch to ON position (WP 0007). Check for 22 to 28 VDC between cab instrument panel wire harness wire 2848 (red) at bumper turret control connector, terminal 1 and a known good ground.

If 22 to 28 VDC are present, replace bumper turret control (WP 0570).

---

**MALFUNCTION****TEST OR INSPECTION****CORRECTIVE ACTION**

---

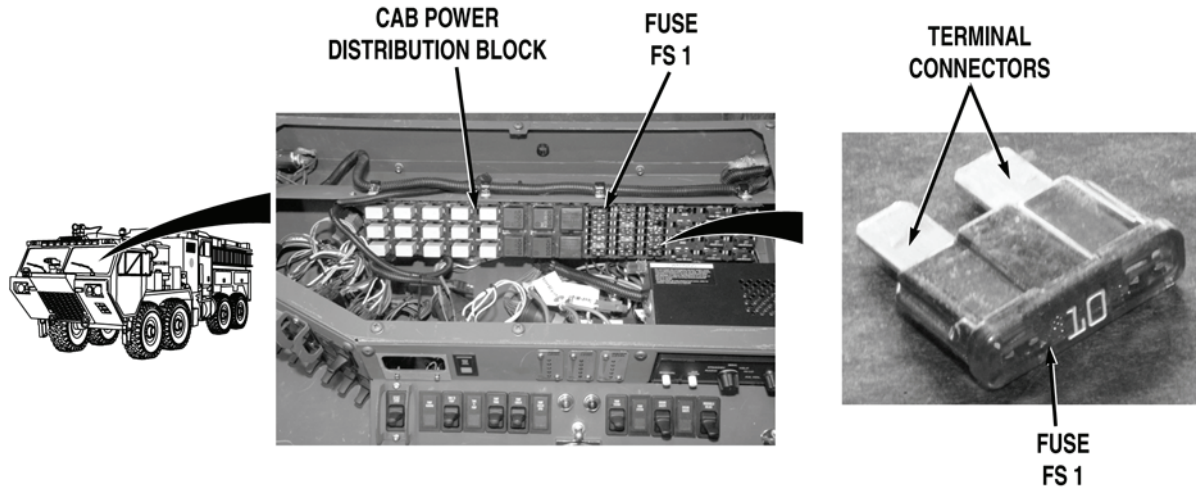

- Step 10. Turn battery disconnect switch to OFF position (WP 0007). Remove cab instrument panel A (WP 0311). Remove fuse FS 1 (WP 0401). Check for continuity across fuse FS 1.

If there is no continuity, replace fuse FS 1 (WP 0401).

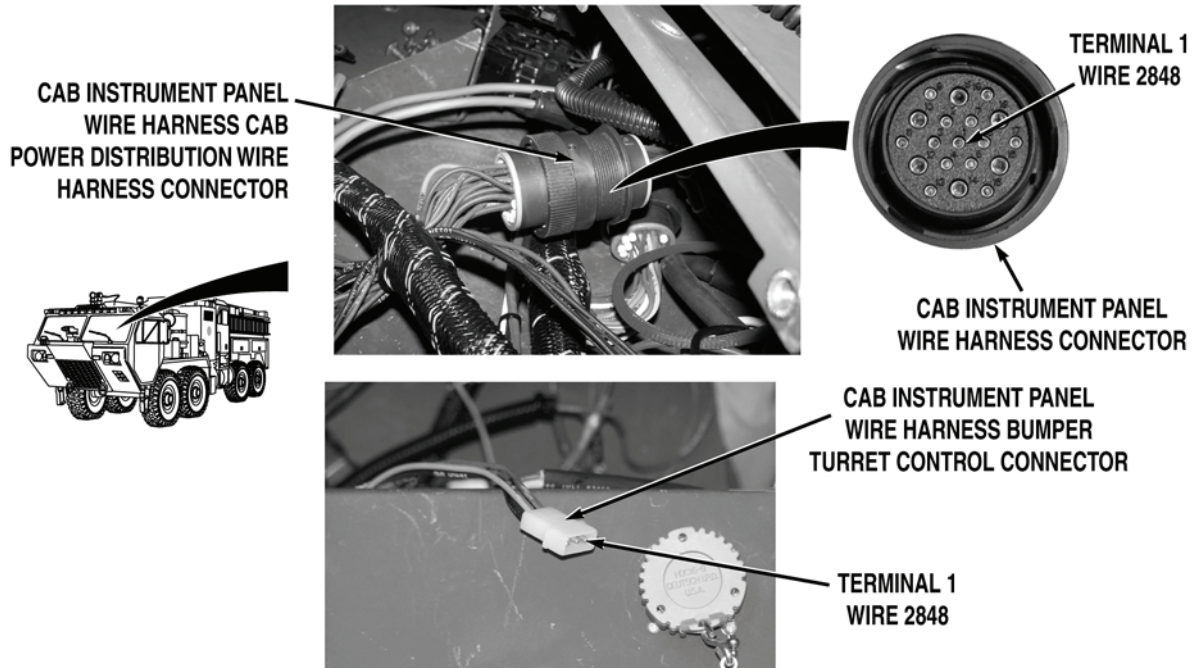
**MALFUNCTION****TEST OR INSPECTION****CORRECTIVE ACTION**

- Step 11. Install fuse FS 1 (WP 0401). Disconnect cab instrument panel wire harness cab power distribution wire harness connector. With a test lead set, check for continuity across cab instrument panel wire harness wire 2848 (red) from cab instrument panel wire harness cab power distribution wire harness connector, terminal 1 to bumper turret control connector, terminal 1.
- a. If there is continuity, repair wire 2848 in cab power distribution wire harness if repairable (TM 9-2320-325-14&P), or replace cab power distribution wire harness and block (WP 0441).
  - b. If there is no continuity, repair wire 2848 in cab instrument panel wire harness if repairable (TM 9-2320-325-14&P), or replace cab instrument panel wire harness (WP 0440).

---

<b>MALFUNCTION</b>		
	<b>TEST OR INSPECTION</b>	
		<b>CORRECTIVE ACTION</b>

---

**WARNING**

**Remove rings, wristwatches, neck chains, and any other jewelry before working around vehicle. Jewelry can catch on equipment and cause serious injury. Jewelry and tools may short across electrical circuits and cause damage to equipment, or severe burns or electrical shock to personnel.**

- Step 12. Release bumper turret control discharge switch (WP 0004). Install bumper turret control cover and tighten four screws. Remove driver side crew cab panel (WP 0499). Remove pump house panel Q (WP 0540). Disconnect main wire harness pump operator's panel wire harness connector. While an assistant pushes and holds bumper turret control discharge switch (WP 0004), with a test lead set, check for 22 to 28 VDC between main wire harness DV1 wire 2837 (gray) at main wire harness pump house wire harness connector, terminal 16 and a known good ground.

If 22 to 28 VDC are present, repair wire 2837 in pump operator's panel wire harness if repairable (TM 9-2320-325-14&P), or replace pump operator's panel wire harness (WP 0459).

**MALFUNCTION**

**TEST OR INSPECTION**

**CORRECTIVE ACTION**

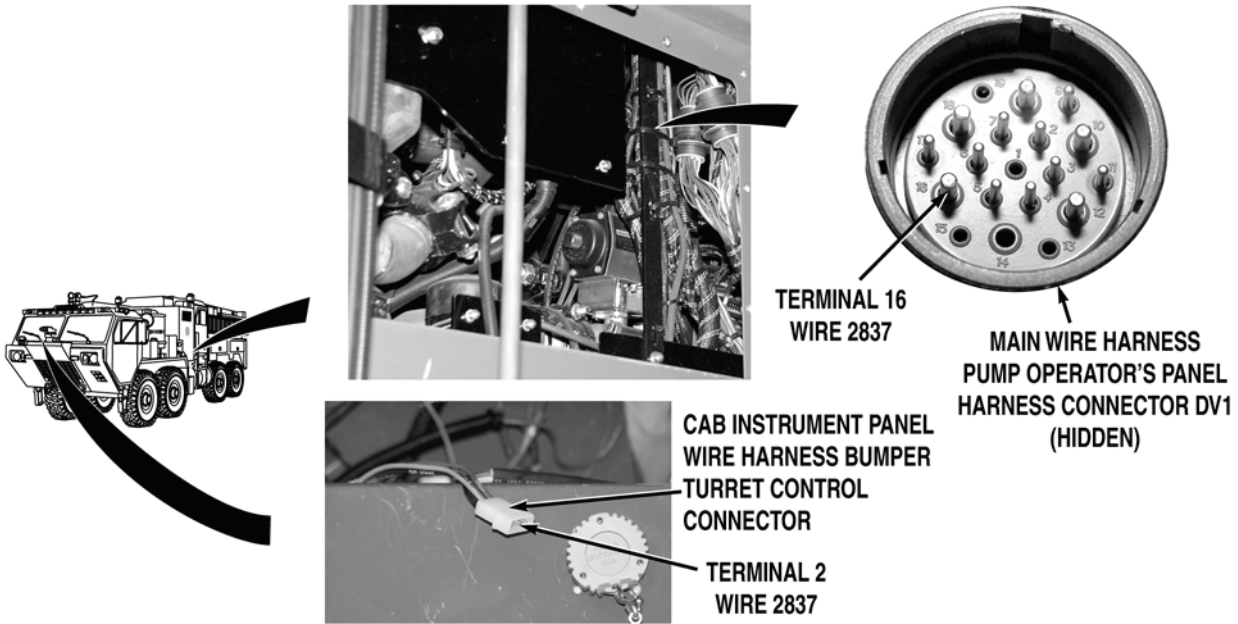

Step 13. Release bumper turret control discharge switch (WP 0035). Put bumper turret control POWER switch to ○ (off) position (WP 0035). Turn battery disconnect switch to OFF position (WP 0007). Remove cab instrument panel E (WP 0311). Disconnect cab instrument panel wire harness bumper turret control connector. With a test lead set, check for continuity across wire 2837 (gray) from cab instrument panel wire harness bumper turret control connector, terminal 2 to main wire harness pump operator's panel wire harness connector DV1, terminal 16.

If there is continuity, replace bumper turret control (WP 0570).



**MALFUNCTION**  
**TEST OR INSPECTION**  
**CORRECTIVE ACTION**

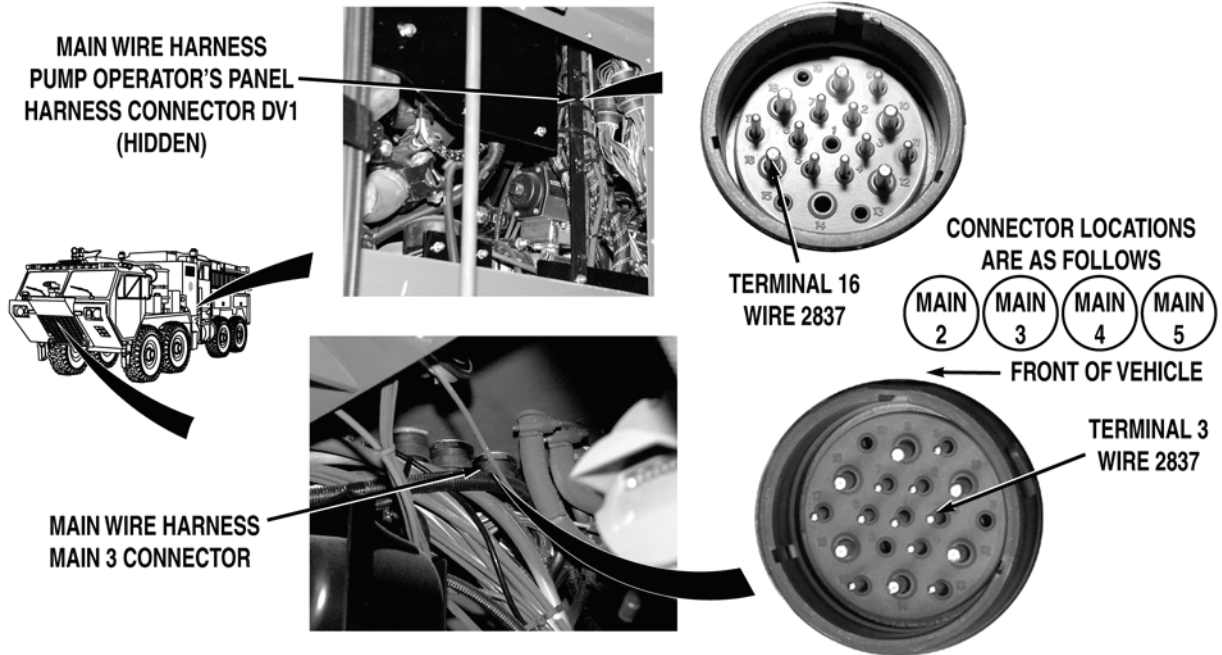

- Step 14. Remove skid plate grille (WP 0550). Disconnect main wire harness main 3 connector. With a test lead set, check for continuity across main wire harness wire 2837 (gray) from main wire harness main 3 connector, terminal 3 to main wire harness pump operator's panel wire harness connector DV1, terminal 16.
- a. If there is continuity, repair wire 2837 in cab instrument panel wire harness if repairable (TM 9-2320-325-14&P), or replace cab instrument panel wire harness (WP 0440).
  - b. If there is no continuity, repair wire 2837 in main wire harness if repairable (TM 9-2320-325-14&P), or replace main wire harness (WP 0455).

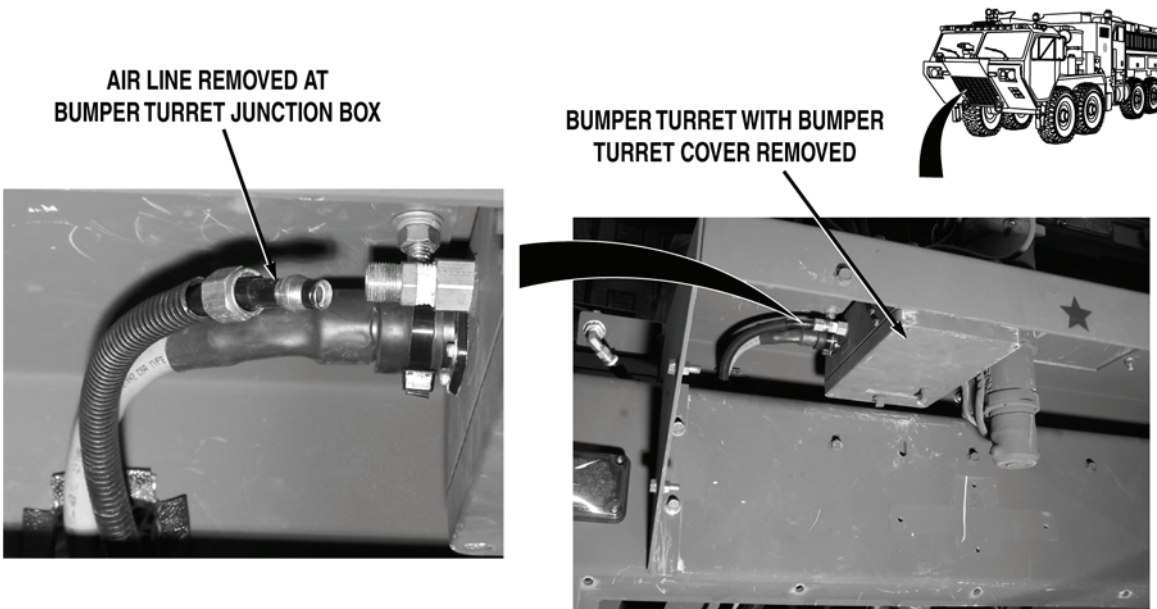
**MALFUNCTION****TEST OR INSPECTION****CORRECTIVE ACTION****WARNING**

**If air lines are under pressure when they are disconnected, they can whip around and cause injury to personnel. Caution should be exercised when disconnecting air line fittings.**

**NOTE**

Air pressure is checked by disconnecting air lines at bumper turret junction box and observing air pressure escaping from air line. System air pressure may drop below 85 psi (586 kPa) during this procedure.

- Step 15. Release bumper turret control discharge switch (WP 0004). Remove bumper turret junction box cover (WP 0572). Disconnect air line at bumper turret junction box. Check if air pressure is present at bumper turret junction box.

If there is no air pressure, replace air line to bumper turret junction box (WP 0567).

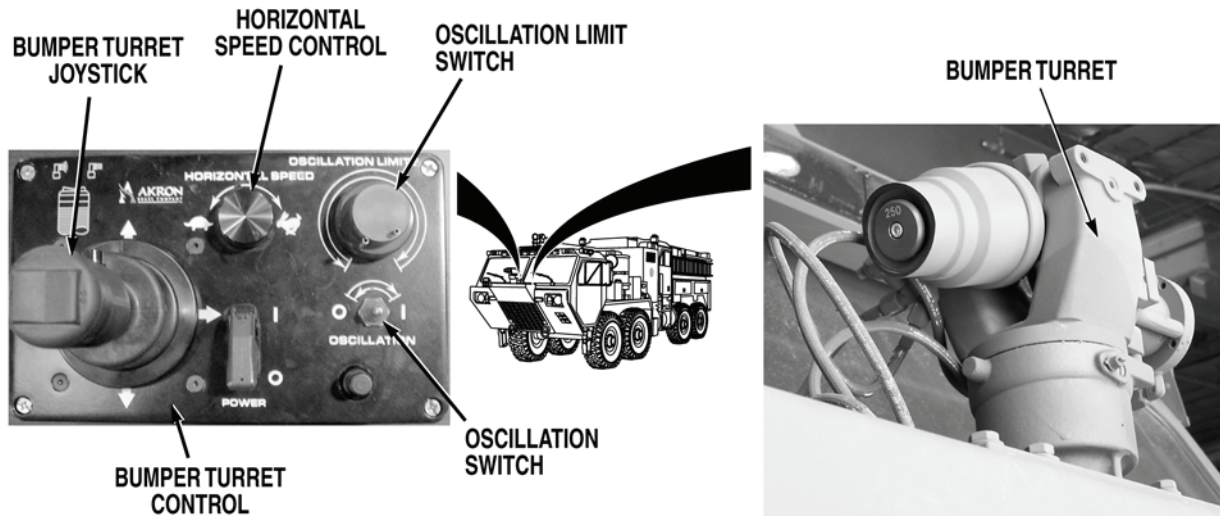
**MALFUNCTION****TEST OR INSPECTION****CORRECTIVE ACTION**

- Step 16. Connect air line at bumper turret junction box. Set bumper turret control HORIZONTAL SPEED to fast (fully clockwise) position (WP 0035). Operate bumper turret control joystick to left and right positions (WP 0035). Check if bumper turret rotates to driver side and passenger side of vehicle.

If bumper turret does not rotate, go to Step 71.

- Step 17. Put bumper turret control OSCILLATION switch to | (on) position (WP 0035). Set bumper turret control OSCILLATION LIMITS control knobs to left and right limits for system operations check (WP 0035). Check if bumper turret oscillates to limits selected.

If bumper turret does not oscillate to limits selected or stops at hard stop, go to Step 62.

- Step 18. Adjust bumper turret control HORIZONTAL SPEED control (WP 0035). Check if bumper turret oscillation speed varies when control is adjusted.

If bumper turret oscillation speed does not vary, replace bumper turret control (WP 0570).

## MALFUNCTION

## TEST OR INSPECTION

## CORRECTIVE ACTION



Step 19. Put bumper turret control OSCILLATION switch to  $\bigcirc$  (off) position (WP 0035). Operate bumper turret control joystick in forward and rear positions (WP 0035), check if bumper turret raises and lowers.

If bumper turret does not raise and lower, go to Step 39.

Step 20. Operate bumper turret control joystick in forward and rear positions (WP 0035), check if bumper turret raises and lowers at a rate suitable for system operations.

If bumper turret does not raise and lower at a rate suitable for system operations, go to Step 61.

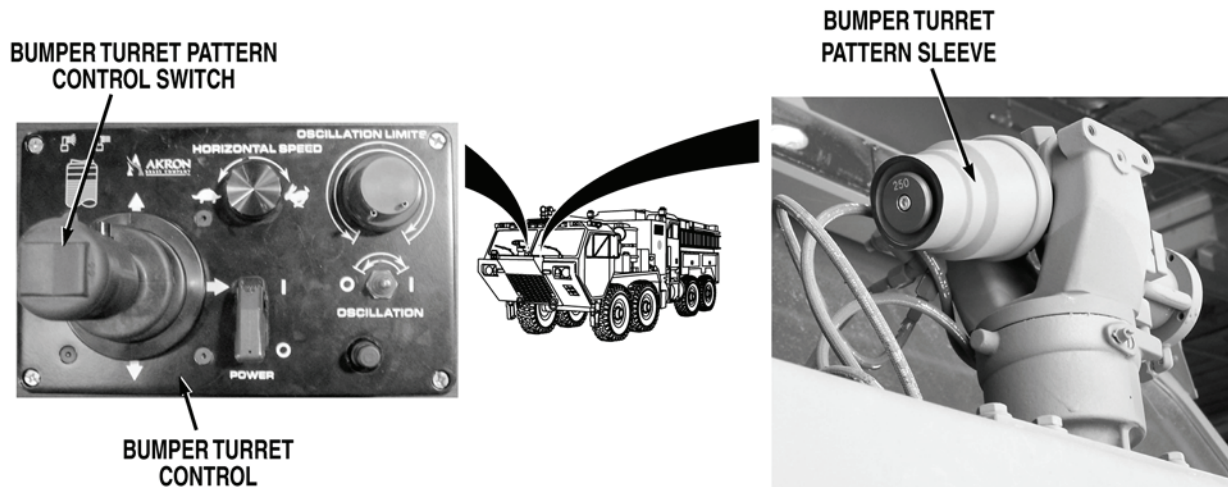
**MALFUNCTION****TEST OR INSPECTION****CORRECTIVE ACTION**

Step 21. Check bumper turret pattern sleeve for blockage and debris.

If bumper turret pattern sleeve is not free from blockage and debris, remove blockage and debris, and go to Step 22.

**NOTE**

Bumper turret pattern sleeve shifts from stream-to-fog/fog-to-stream positions with air pressure. Bumper turret pattern sleeve will shift from fog-to-stream at a slower rate as system water pressure is increased.

Step 22. While an assistant pushes bumper turret control pattern control switch (WP 0035), check if bumper turret pattern sleeve shifts to stream and fog positions.

If bumper turret pattern sleeve does not shift to stream and fog positions, go to Step 24.

Step 23. While an assistant pushes bumper turret control pattern control switch (WP 0035), check if bumper turret pattern sleeve shifts to stream and fog positions at a rate suitable for system operations.

- a. If bumper turret pattern sleeve shifts at a rate suitable for system operations, fault corrected.
- b. If bumper turret pattern sleeve does not shift at a suitable rate for system operations, go to Step 38.

**MALFUNCTION**

**TEST OR INSPECTION**

**CORRECTIVE ACTION**

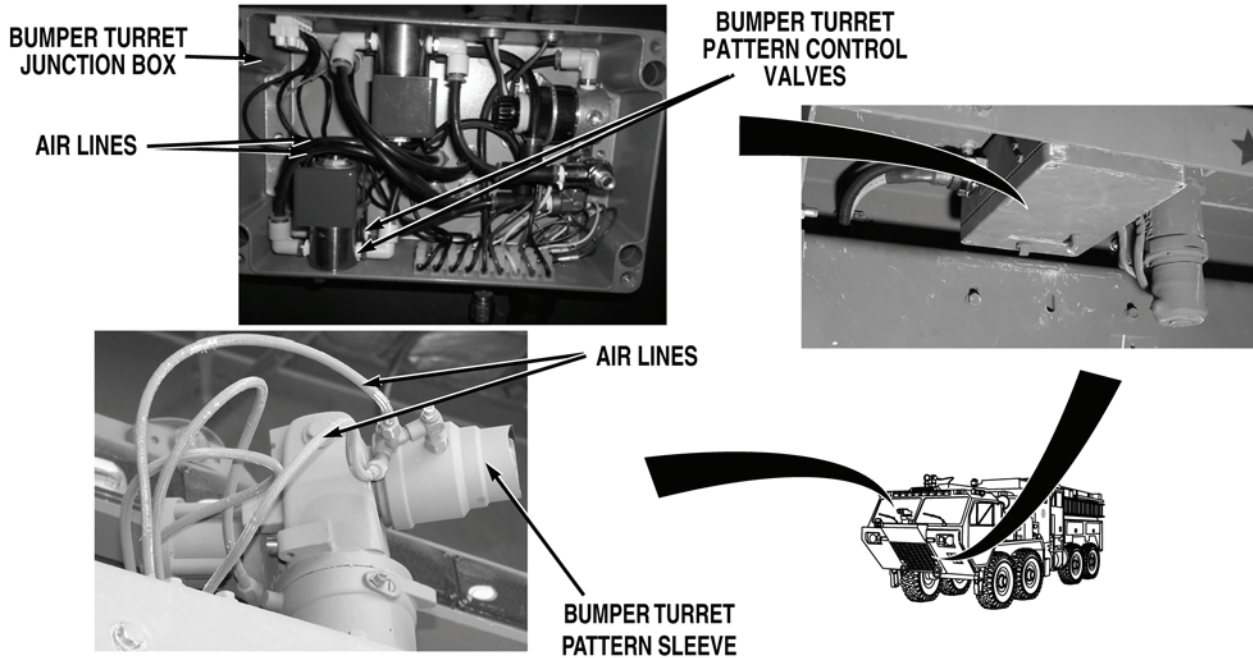

**WARNING**



**Remove rings, wristwatches, neck chains, and any other jewelry before working around vehicle. Jewelry can catch on equipment and cause serious injury. Jewelry and tools may short across electrical circuits and cause damage to equipment, or severe burns or electrical shock to personnel.**

Step 24. Remove bumper turret junction box cover (WP 0572). While an assistant pushes bumper turret control pattern control switch (WP 0035), check air lines and fittings from bumper turret pattern control valves to bumper turret pattern sleeve for leaks, kinks, and damage.

If air lines and/or fittings leak, are kinked or are damaged, repair leaks or replace bumper turret air lines and/or fittings (WP 0571) or bumper turret junction box air lines and/or fittings (WP 0573).

Step 25. While an assistant pushes bumper turret control pattern control switch to fog position (WP 0035). Check if bumper turret pattern sleeve shifts to fog (retracted) position.

If bumper turret pattern sleeve does not shift to fog (retracted) position, go to Step 32.

---

<b>MALFUNCTION</b>	
<b>TEST OR INSPECTION</b>	
	<b>CORRECTIVE ACTION</b>

---

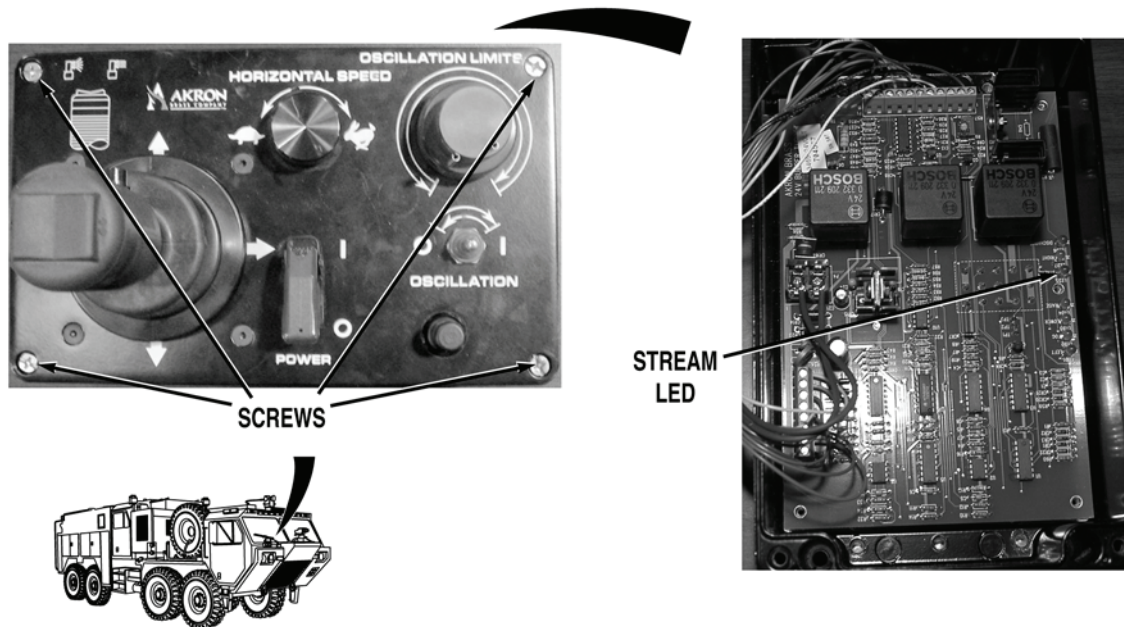
**WARNING**

Remove rings, wristwatches, neck chains, and any other jewelry before working around vehicle. Jewelry can catch on equipment and cause serious injury. Jewelry and tools may short across electrical circuits and cause damage to equipment, or severe burns or electrical shock to personnel.

- Step 26. Loosen four screws and remove bumper turret control cover. Do not disconnect wires. While pushing bumper turret control pattern control switch to stream position (WP 0035), check if bumper turret control STREAM LED illuminates.

If bumper turret control STREAM LED does not illuminate, replace bumper turret control (WP 0570).

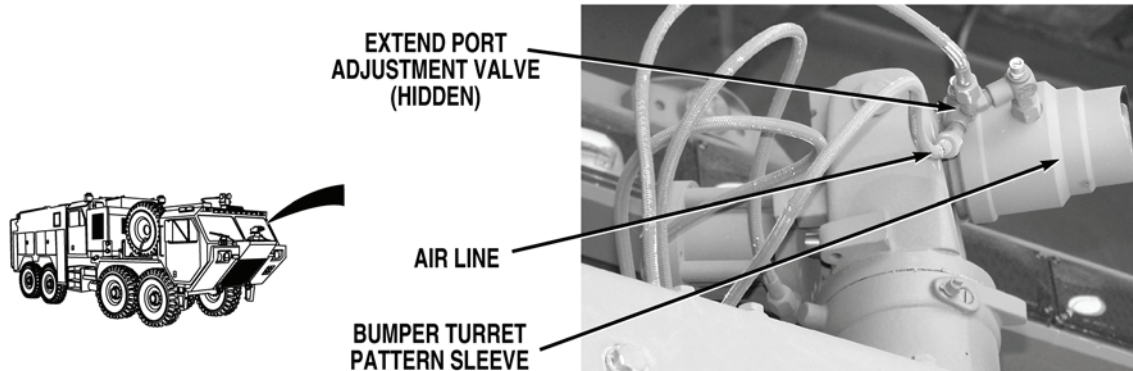
**MALFUNCTION****TEST OR INSPECTION****CORRECTIVE ACTION****WARNING**

- If air lines are under pressure when they are disconnected, they can whip around and cause injury to personnel. Caution should be exercised when disconnecting air line fittings.
- Air lines may be under pressure when control valve is operated. If under pressure and air lines are disconnected, air lines may whip around and cause injury to personnel. Caution should be exercised when operating control valve with air lines disconnected.

**NOTE**

Air pressure is checked by disconnecting air line at bumper turret pattern sleeve and observing air pressure escaping from air line when bumper turret control is activated.

- Step 27. Install bumper turret control cover and tighten four screws. Disconnect air line at bumper turret pattern sleeve extend port. Do not remove adjustment valve from sleeve. While an assistant pushes bumper turret control pattern control switch to stream position (WP 0035), check if air pressure is present at bumper turret pattern sleeve extend port. Connect air line at bumper turret pattern sleeve extend port.

If air pressure is present, go to Step 38.



## MALFUNCTION

## TEST OR INSPECTION

## CORRECTIVE ACTION

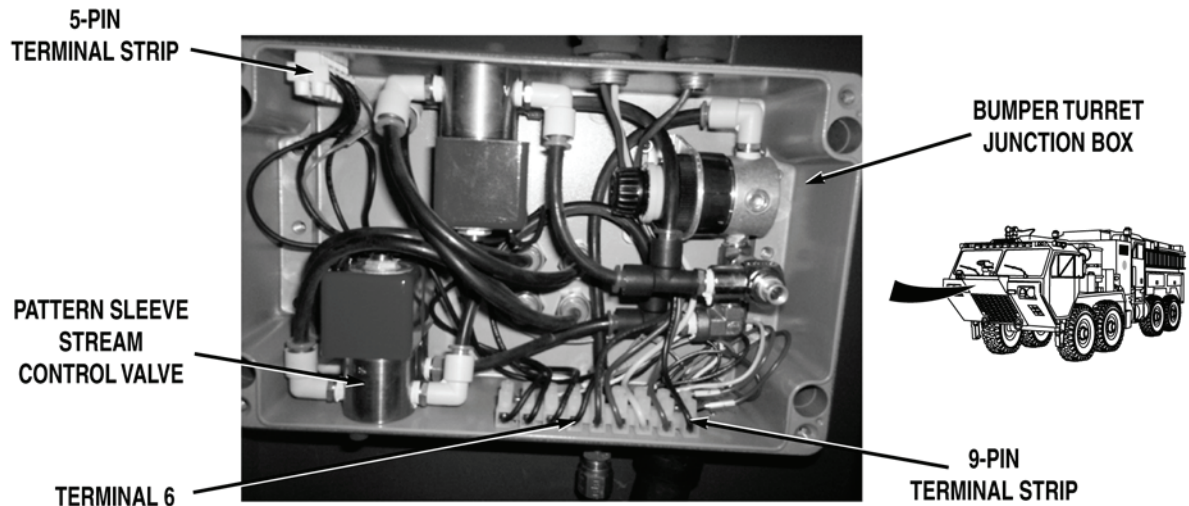
**WARNING**

**Remove rings, wristwatches, neck chains, and any other jewelry before working around vehicle. Jewelry can catch on equipment and cause serious injury. Jewelry and tools may short across electrical circuits and cause damage to equipment, or severe burns or electrical shock to personnel.**

- Step 28. Connect air line at bumper turret pattern sleeve extend port. While an assistant pushes bumper turret control pattern control switch to stream position (WP 0035), check for 22 to 28 VDC between stream wire (black) at bumper turret junction box 9-pin terminal strip, terminal 6 and a known good ground.

If 22 to 28 VDC are not present, go to Step 30.

- Step 29. Put bumper turret control POWER switch to  $\bigcirc$  (off) position (WP 0035). Turn battery disconnect switch to OFF position (WP 0007). Check connections at bumper turret junction box 9-pin and 5-pin terminal strips for loose connections.
- If connections are loose, tighten loose connections (WP 0573).
  - If connections are not loose, replace bumper turret junction box pattern sleeve stream control valve (WP 0573).

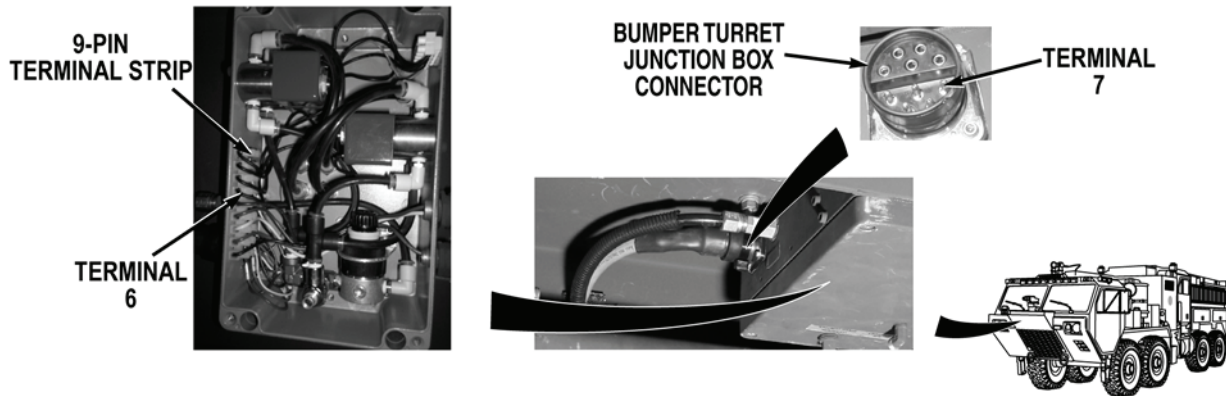
**MALFUNCTION****TEST OR INSPECTION****CORRECTIVE ACTION**

- Step 30. Put bumper turret control POWER switch to  $\bigcirc$  (off) position (WP 0035). Turn battery disconnect switch to OFF position (WP 0007). Disconnect bumper turret wire harness bumper turret junction box connector. Check for continuity across bumper turret junction box stream wire (black) from bumper turret junction box connector, terminal 7 to bumper turret junction box 9-pin terminal strip, terminal 6.

If there is no continuity, repair bumper turret junction box stream wire in bumper turret junction box wire harness if repairable (TM 9-2320-325-14&P), or replace bumper turret junction box wire harness (WP 0573).

## MALFUNCTION

## TEST OR INSPECTION

## CORRECTIVE ACTION

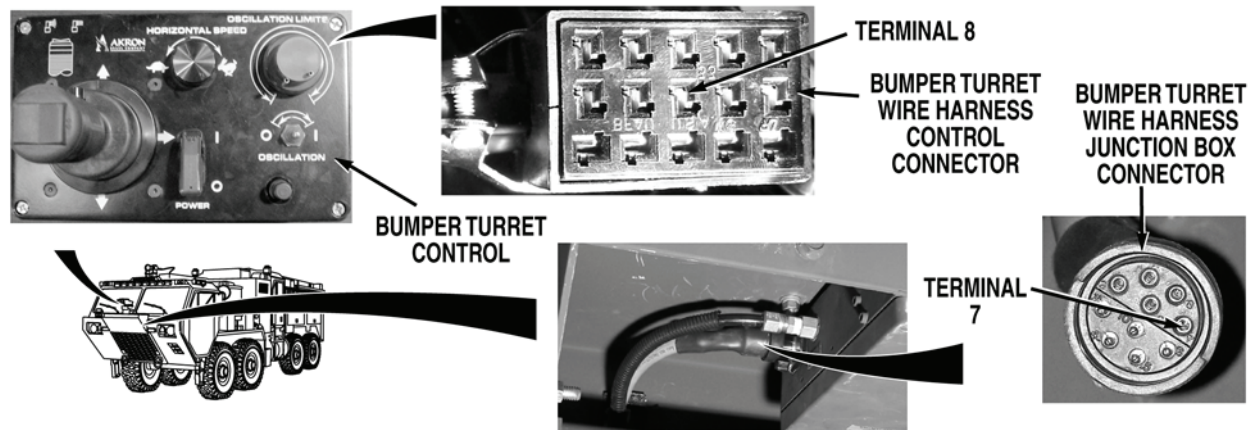

- Step 31. Remove cab instrument panel E (WP 0311). Disconnect bumper turret wire harness bumper turret control connector. With a test lead set, check for continuity across bumper turret wire harness stream wire (black) from bumper turret wire harness bumper turret control connector, terminal 8 to bumper turret wire harness junction box connector, terminal 7.
- If there is continuity, replace bumper turret control (WP 0570).
  - If there is no continuity, repair bumper turret wire harness stream wire in bumper turret wire harness if repairable (TM 9-2320-325-14&P), or replace bumper turret wire harness (WP 0437).

MALFUNCTION

TEST OR INSPECTION

CORRECTIVE ACTION

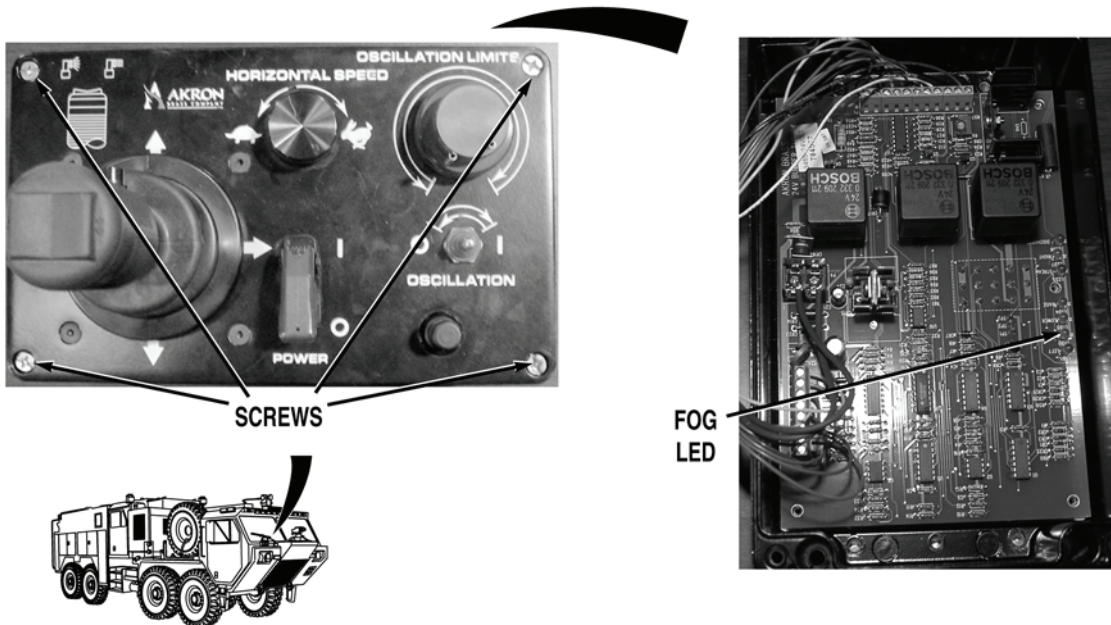

**WARNING**



Remove rings, wristwatches, neck chains, and any other jewelry before working around vehicle. Jewelry can catch on equipment and cause serious injury. Jewelry and tools may short across electrical circuits and cause damage to equipment, or severe burns or electrical shock to personnel.

Step 32. Loosen four screws and remove bumper turret control cover. Do not disconnect wires. While pushing bumper turret control pattern control switch to fog position (WP 0035), check if bumper turret control FOG LED illuminates.

If bumper turret control FOG LED does not illuminate, replace bumper turret control (WP 0570).

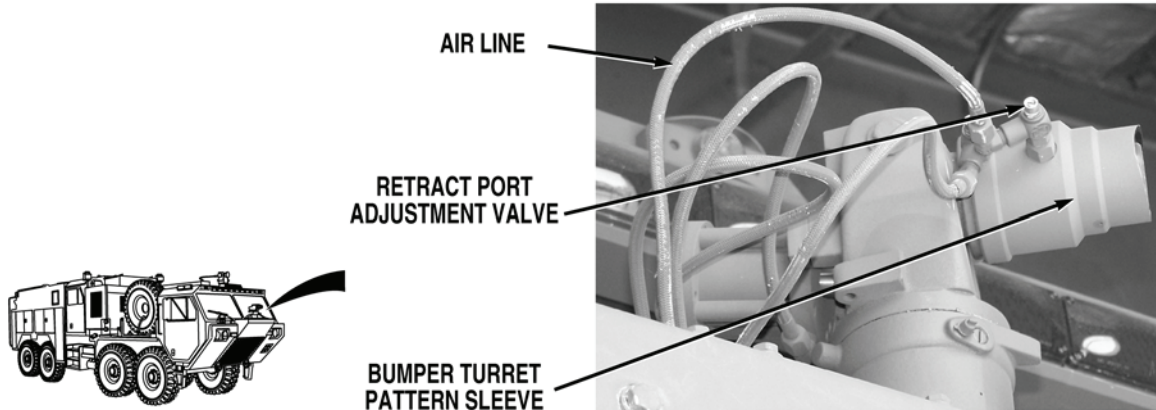
**MALFUNCTION****TEST OR INSPECTION****CORRECTIVE ACTION****WARNING**

- If air lines are under pressure when they are disconnected, they can whip around and cause injury to personnel. Caution should be exercised when disconnecting air line fittings.
- Air lines may be under pressure when control valve is operated. If under pressure and air lines are disconnected, air lines may whip around and cause injury to personnel. Caution should be exercised when operating control valve with air lines disconnected.

**NOTE**

Air pressure is checked by disconnecting air line at bumper turret pattern sleeve and observing air pressure escaping from air line, when bumper turret control is activated.

- Step 33. Install bumper turret control cover and tighten four screws. Disconnect air line at bumper turret pattern sleeve retract port. Do not remove adjustment valve from sleeve. While an assistant pushes bumper turret control pattern control switch to fog position (WP 0035), check if air pressure is present at bumper turret pattern sleeve retract port. Connect air line at bumper turret pattern sleeve retract port.

If air pressure is present, go to Step 38.

## MALFUNCTION

## TEST OR INSPECTION

## CORRECTIVE ACTION

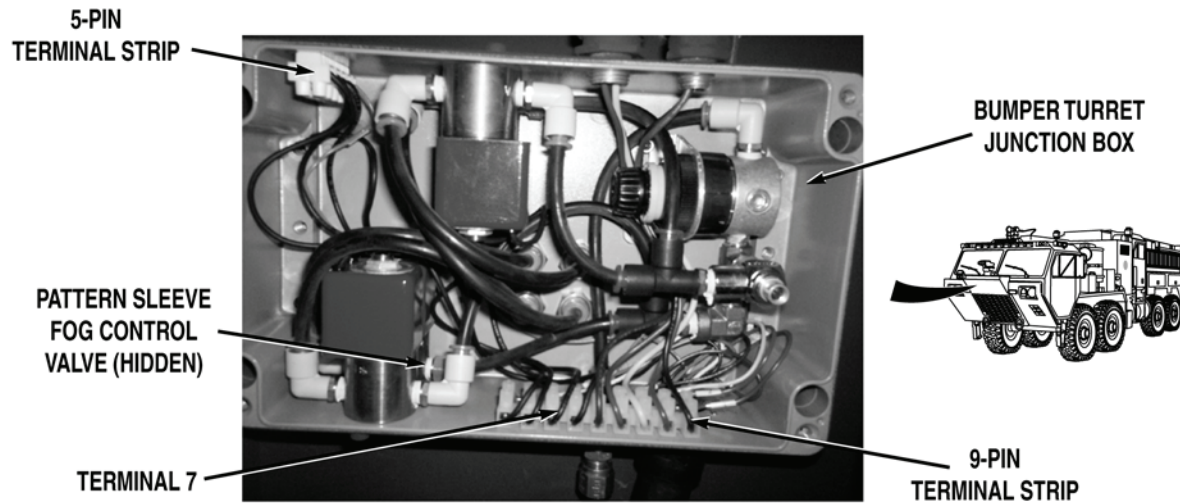
**WARNING**

Remove rings, wristwatches, neck chains, and any other jewelry before working around vehicle. Jewelry can catch on equipment and cause serious injury. Jewelry and tools may short across electrical circuits and cause damage to equipment, or severe burns or electrical shock to personnel.

Step 34. While an assistant pushes bumper turret control pattern control switch to fog position (WP 0035), check for 22 to 28 VDC between fog wire (black) at bumper turret junction box 9-pin terminal strip, terminal 7 and a known good ground.

If 22 to 28 VDC are not present, go to Step 36.

Step 35. Put bumper turret control POWER switch to  $\bigcirc$  (off) position (WP 0035). Turn battery disconnect switch to OFF position (WP 0007). Check connections at bumper turret junction box 9-pin and 5-pin terminal strips for loose connections.

- a. If connections are loose, tighten loose connections (WP 0573).
- b. If connections are not loose, replace bumper turret junction box pattern sleeve fog control valve (WP 0573).

**MALFUNCTION**  
**TEST OR INSPECTION**  
**CORRECTIVE ACTION**

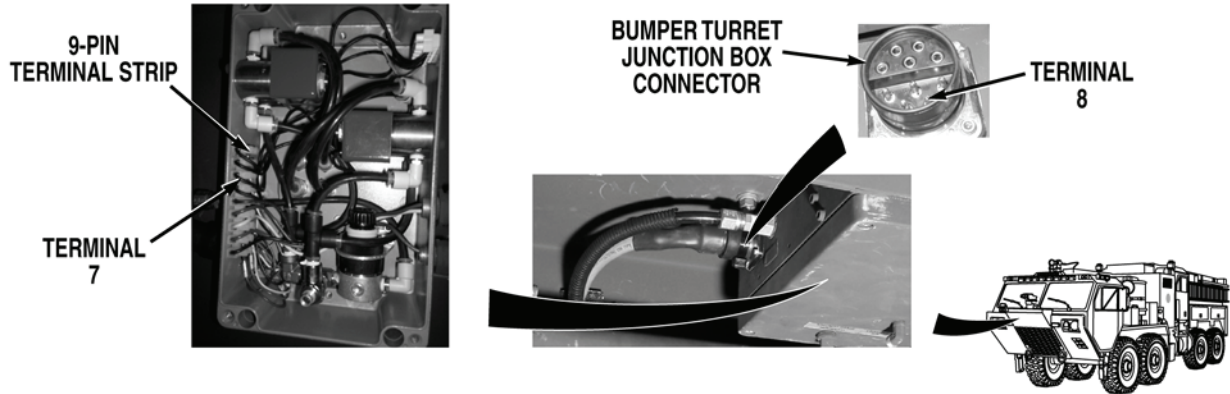

Step 36. Put bumper turret control POWER switch to  $\bigcirc$  (off) position (WP 0035). Turn battery disconnect switch to OFF position (WP 0007). Disconnect bumper turret wire harness bumper turret junction box connector. Check for continuity across bumper turret junction box fog wire (black) from bumper turret junction box connector, terminal 8 to bumper turret junction box 9-pin terminal strip, terminal 7.

If there is no continuity, repair bumper turret junction box fog wire in bumper turret junction box wire harness if repairable (TM 9-2320-325-14&P), or replace bumper turret junction box wire harness (WP 0573).

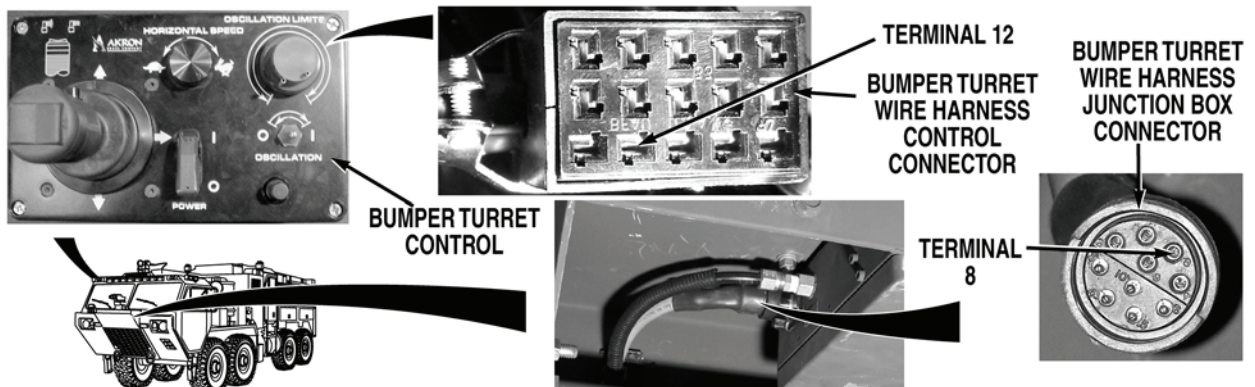

Step 37. Remove cab instrument panel E (WP 0311). Disconnect bumper turret wire harness bumper turret control connector. With a test lead set, check for continuity across bumper turret wire harness fog wire (black) from bumper turret wire harness bumper turret control connector, terminal 12 to bumper turret wire harness junction box connector, terminal 8.

- a. If there is continuity, replace bumper turret control (WP 0570).
- b. If there is no continuity, repair bumper turret wire harness fog wire in bumper turret wire harness if repairable (TM 9-2320-325-14&P), or replace bumper turret wire harness (WP 0437).

---

**MALFUNCTION****TEST OR INSPECTION****CORRECTIVE ACTION**

---

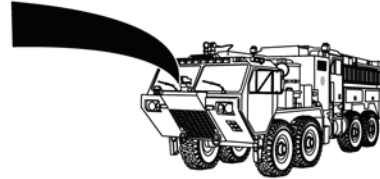
**BUMPER TURRET  
PATTERN SLEEVE****WARNING**

**Remove rings, wristwatches, neck chains, and any other jewelry before working around vehicle. Jewelry can catch on equipment and cause serious injury. Jewelry and tools may short across electrical circuits and cause damage to equipment, or severe burns or electrical shock to personnel.**

- Step 38. Adjust bumper turret (WP 0188). Check if bumper turret pattern sleeve shift rate can be adjusted so pattern sleeve shifts to stream and fog positions at a rate suitable for system operations.
- a. If bumper turret pattern shift rate adjusts to a rate suitable for system operations, fault corrected.
  - b. If bumper turret pattern shift rate cannot be adjusted, replace bumper turret pattern sleeve (WP 0571).



MALFUNCTION	TEST OR INSPECTION	CORRECTIVE ACTION
-------------	--------------------	-------------------

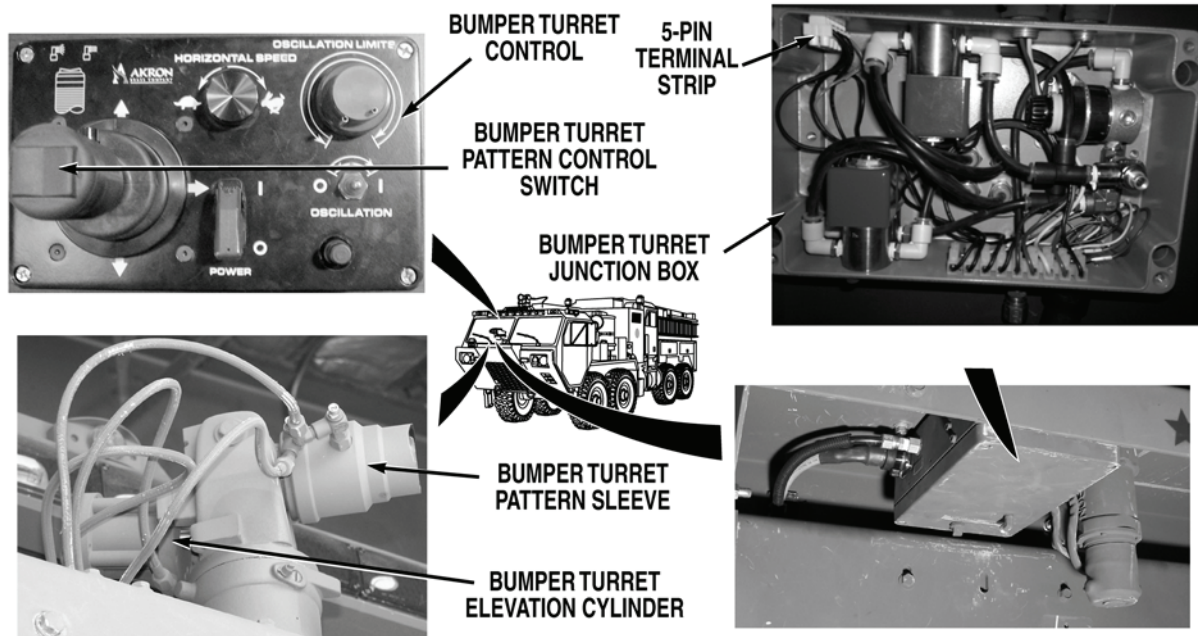

Step 39. While an assistant pushes bumper turret control pattern control switch (WP 0035), check if bumper turret pattern sleeve shifts to stream and fog positions.

If bumper turret pattern sleeve shifts to stream and fog positions, go to Step 44.

Step 40. Put bumper turret control POWER switch to ○ (off) position (WP 0035). Turn battery disconnect switch to OFF position (WP 0007). Remove bumper turret junction box cover (WP 0572). Check connections at bumper turret junction box 5-pin terminal strip for loose connections.

If connections are loose, tighten loose connections (WP 0573).

Step 41. Check for continuity across bumper turret junction box ground wire (black) from bumper turret junction box 5-pin terminal strip to a known good ground.

If there is continuity, replace bumper turret junction box air regulator (WP 0573).

**MALFUNCTION**

**TEST OR INSPECTION**

**CORRECTIVE ACTION**

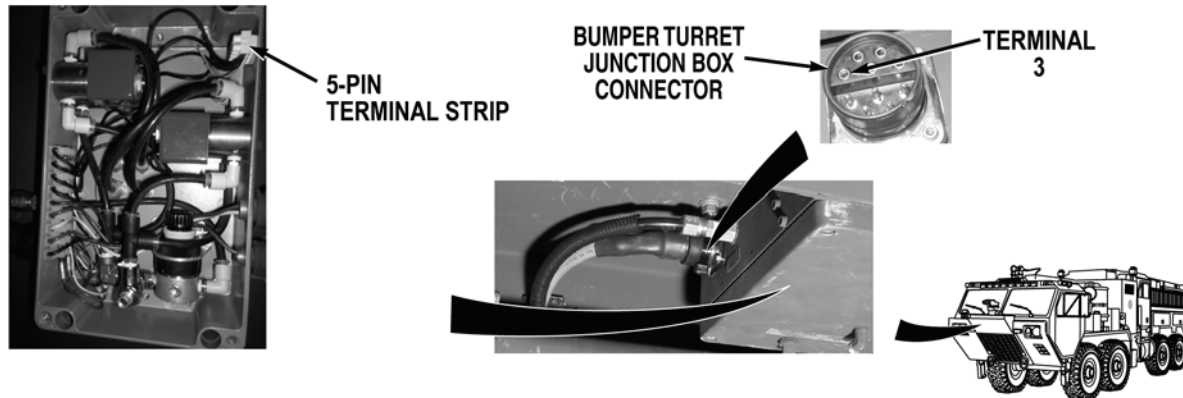

Step 42. Disconnect bumper turret wire harness junction box connector. Check for continuity across bumper turret junction box ground wire (black) from bumper turret junction box connector, terminal 3 to bumper turret junction box 5-pin terminal strip.

If there is no continuity, repair bumper turret junction box ground wire in bumper turret junction box wire harness if repairable (TM 9-2320-325-14&P), or replace bumper turret junction box wire harness (WP 0573).

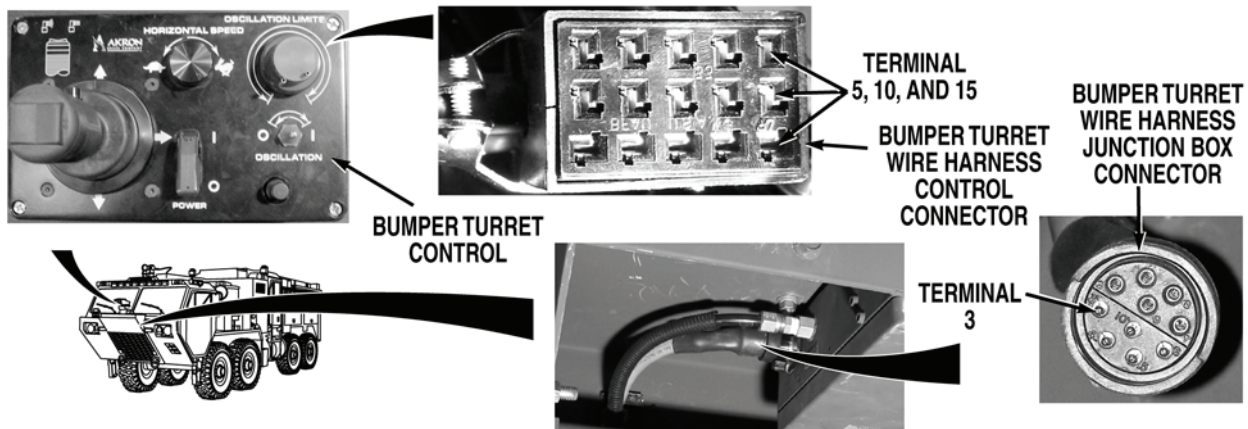

Step 43. Remove cab instrument panel E (WP 0311). Disconnect bumper turret wire harness bumper turret control connector. With a test lead set, check for continuity across bumper turret wire harness ground wire (black) from bumper turret wire harness bumper turret control connector, terminals 5, 10, and 15 to bumper turret wire harness bumper turret junction box connector, terminal 3.

- a. If there is continuity, replace bumper turret control (WP 0570).
- b. If there is no continuity, repair bumper turret wire harness ground wire in bumper turret wire harness if repairable (TM 9-2320-325-14&P), or replace bumper turret wire harness (WP 0437).

---

**MALFUNCTION****TEST OR INSPECTION****CORRECTIVE ACTION**

---

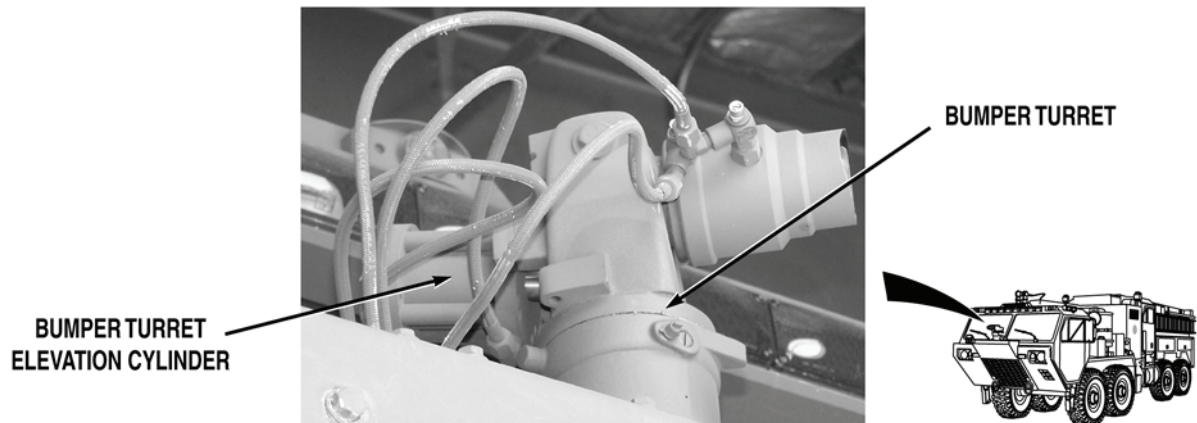

Step 44. Check bumper turret elevation cylinder for blockage and debris.

If bumper turret elevation cylinder is not free from blockage and debris, remove blockage and debris and go to Step 45.

Step 45. While an assistant operates bumper turret control joystick in forward and rear positions (WP 0004), check if bumper turret raises and lowers.

If bumper turret does not raise and lower, go to Step 47.

Step 46. While an assistant operates bumper turret control joystick in forward and rear positions (WP 0004), check if bumper turret raises and lowers at a rate suitable for system operations.

- a. If bumper turret raises and lowers at a rate suitable for system operations, fault corrected.
- b. If bumper turret does not raise and lower at a suitable rate for system operations, go to Step 61.

**MALFUNCTION**

**TEST OR INSPECTION**

**CORRECTIVE ACTION**

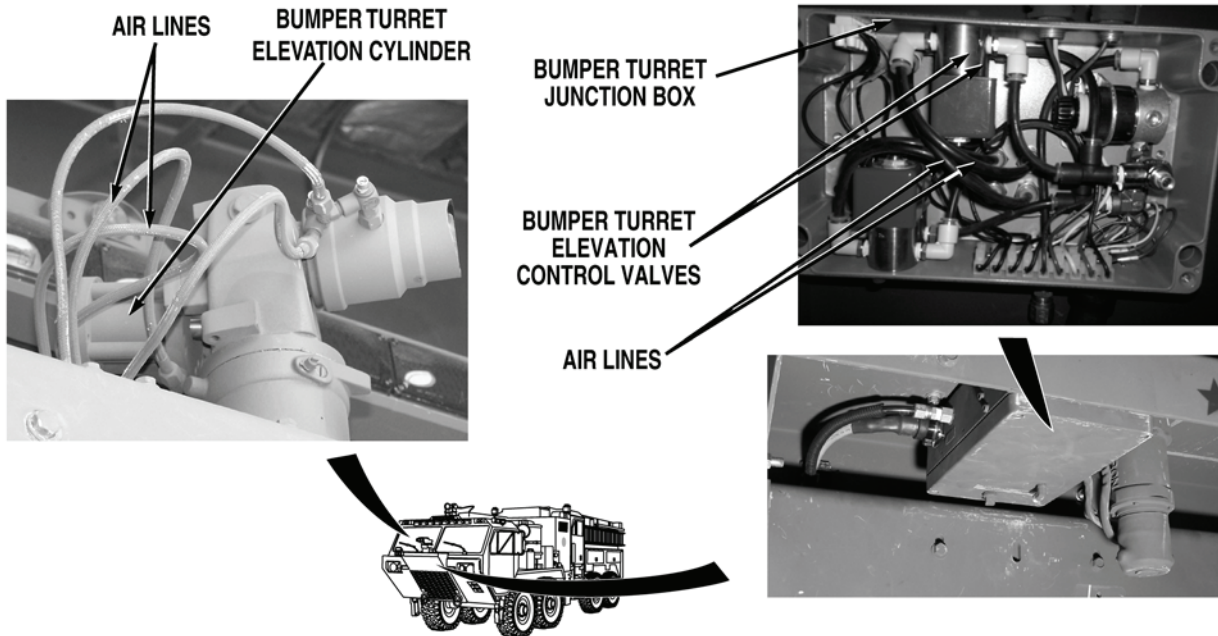

**WARNING**



**Remove rings, wristwatches, neck chains, and any other jewelry before working around vehicle. Jewelry can catch on equipment and cause serious injury. Jewelry and tools may short across electrical circuits and cause damage to equipment, or severe burns or electrical shock to personnel.**

Step 47. Remove bumper turret junction box cover (WP 0572). While an assistant operates bumper turret control joystick in forward and rear positions (WP 0004), check air lines and fittings from bumper turret elevation control valves to bumper turret elevation cylinder for leaks, kinks, and damage.

If air lines and/or fittings leak, are kinked, or are damaged, repair leaks or replace bumper turret air lines and/or fittings (WP 0571) or bumper turret junction box air line and/or fittings (WP 0573).

Step 48. While an assistant operates bumper turret control joystick to forward position (WP 0004). Check if bumper turret shifts to lowered position.

If bumper turret does not shift to lowered position, go to Step 55.

---

**MALFUNCTION**  
**TEST OR INSPECTION**  
**CORRECTIVE ACTION**

---



RAISE  
LED

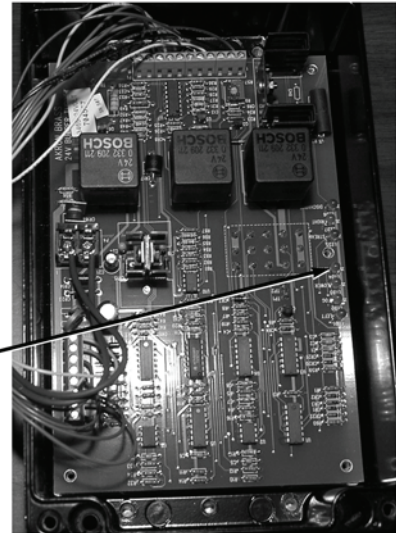

**WARNING**



Remove rings, wristwatches, neck chains, and any other jewelry before working around vehicle. Jewelry can catch on equipment and cause serious injury. Jewelry and tools may short across electrical circuits and cause damage to equipment, or severe burns or electrical shock to personnel.

- Step 49. Loosen four screws and remove bumper turret control cover. Do not disconnect wires. While operating bumper turret control joystick to rear position (WP 0004), check if bumper turret control RAISE LED illuminates.

If bumper turret control RAISE LED does not illuminate, replace bumper turret control (WP 0570).

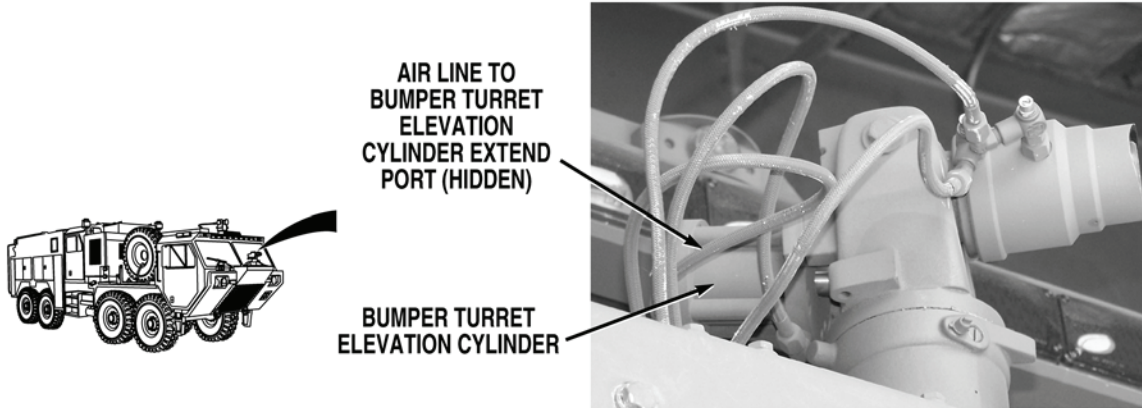
**MALFUNCTION****TEST OR INSPECTION****CORRECTIVE ACTION****WARNING**

- If air lines are under pressure when they are disconnected, they can whip around and cause injury to personnel. Caution should be exercised when disconnecting air line fittings.
- Air lines may be under pressure when control valve is operated. If under pressure and air lines are disconnected, air lines may whip around and cause injury to personnel. Caution should be exercised when operating control valve with air lines disconnected.

**NOTE**

Air pressure is checked by disconnecting air line at bumper turret elevation cylinder and observing air pressure escaping from air line, when bumper turret control is activated.

- Step 50. Install bumper turret control cover and tighten four screws. Disconnect air line at bumper turret elevation cylinder extend port. While an assistant operates bumper turret joystick to rear position (WP 0004), check if air pressure is present at bumper turret elevation cylinder extend port.

If air pressure is present, connect air line at bumper turret elevation cylinder extend port and go to Step 61.

---

<b>MALFUNCTION</b>	
<b>TEST OR INSPECTION</b>	
<b>CORRECTIVE ACTION</b>	

---

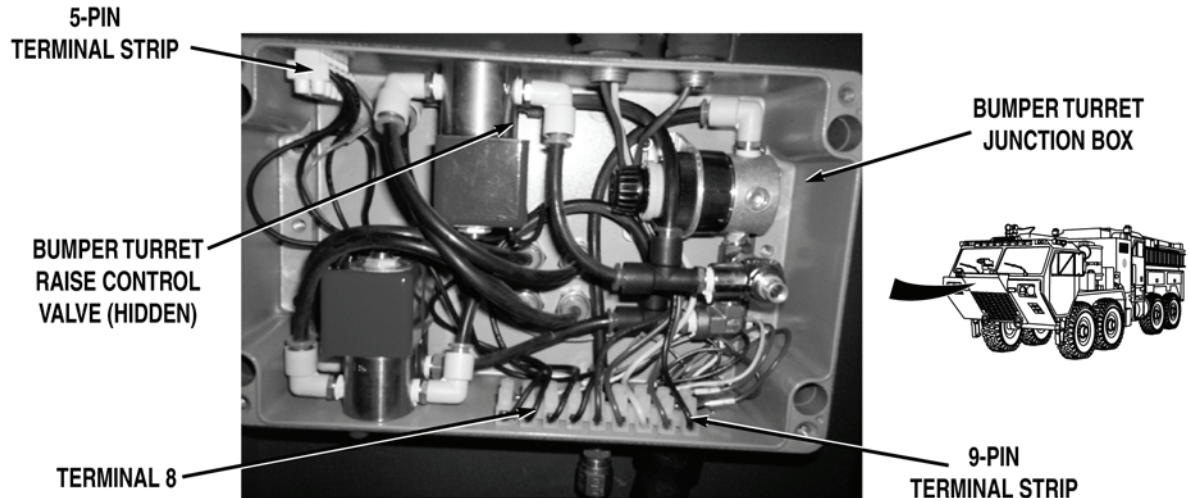
**WARNING**

**Remove rings, wristwatches, neck chains, and any other jewelry before working around vehicle. Jewelry can catch on equipment and cause serious injury. Jewelry and tools may short across electrical circuits and cause damage to equipment, or severe burns or electrical shock to personnel.**

- Step 51. Connect air line at bumper turret elevation cylinder extend port. While an assistant operates bumper turret control joystick to rear position (WP 0004), check for 22 to 28 VDC between bumper turret raise wire (black) at bumper turret junction box 9-pin terminal strip, terminal 8 and a known good ground.

If 22 to 28 VDC are not present, go to Step 53.

- Step 52. Put bumper turret control POWER switch to  $\bigcirc$  (off) position (WP 0004). Turn battery disconnect switch to OFF position (WP 0007). Check connections at bumper turret junction box 9-pin and 5-pin terminal strips for loose connections.
- a. If connections are loose, tighten loose connections (WP 0573).
  - b. If connections are not loose, replace bumper turret raise control valve (WP 0573).

**MALFUNCTION**

**TEST OR INSPECTION**

**CORRECTIVE ACTION**

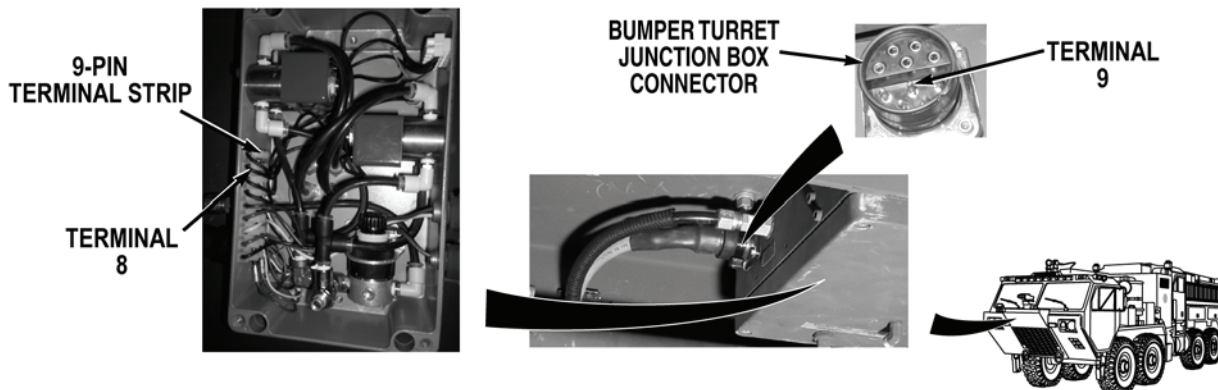

Step 53. Put bumper turret control POWER switch to  $\bigcirc$  (off) position (WP 0004). Turn battery disconnect switch to OFF position (WP 0007). Disconnect bumper turret wire harness bumper turret junction box connector. Check for continuity across bumper turret junction box raise wire (black) from bumper turret junction box connector, terminal 9 to bumper turret junction box 9-pin terminal strip, terminal 8.

If there is no continuity, repair bumper turret junction box raise wire in bumper turret junction box wire harness if repairable (TM 9-2320-325-14&P), or replace bumper turret junction box wire harness (WP 0573).

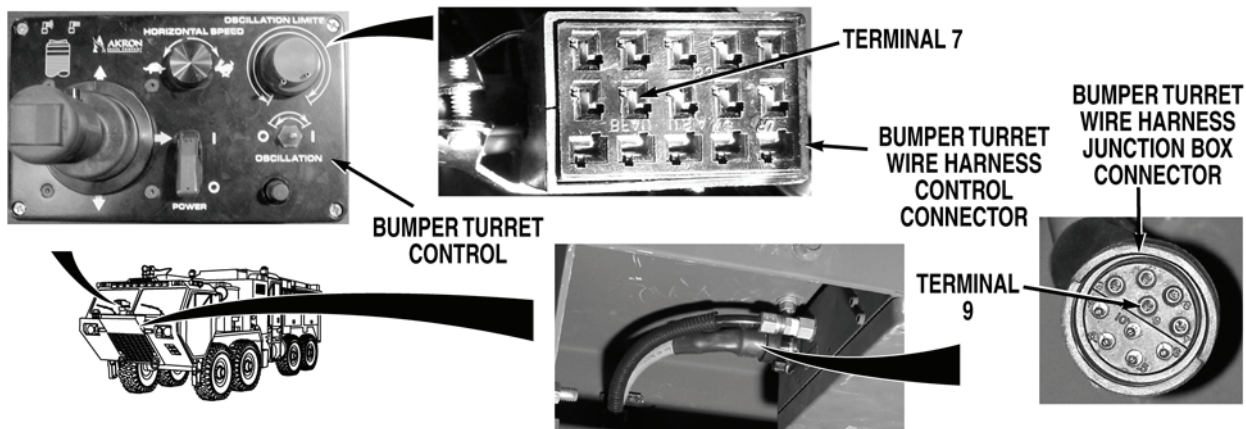

Step 54. Remove cab instrument panel E (WP 0311). Disconnect bumper turret wire harness bumper turret control connector. With a test lead set, check for continuity across bumper turret wire harness raise wire (black) from bumper turret wire harness bumper turret control connector, terminal 7 to bumper turret wire harness bumper turret junction box connector, terminal 9.

- a. If there is continuity, replace bumper turret control (WP 0570).
- b. If there is no continuity, repair bumper turret wire harness raise wire in bumper turret wire harness if repairable (TM 9-2320-325-14&P), or replace bumper turret wire harness (WP 0437).



**MALFUNCTION**  
**TEST OR INSPECTION**  
**CORRECTIVE ACTION**

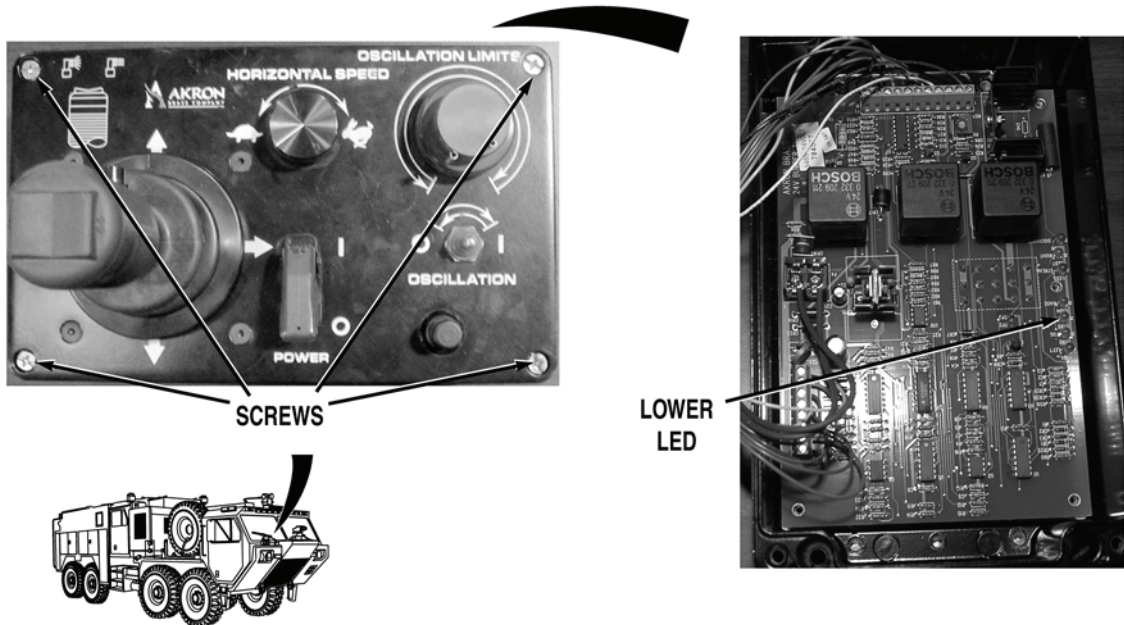

**WARNING**



**Remove rings, wristwatches, neck chains, and any other jewelry before working around vehicle. Jewelry can catch on equipment and cause serious injury. Jewelry and tools may short across electrical circuits and cause damage to equipment, or severe burns or electrical shock to personnel.**

Step 55. Loosen four screws and remove bumper turret control cover. Do not disconnect wires. While operating bumper turret control joystick to forward position (WP 0004), check if bumper turret control LOWER LED illuminates.

If bumper turret control LOWER LED does not illuminate, replace bumper turret control (WP 0570).

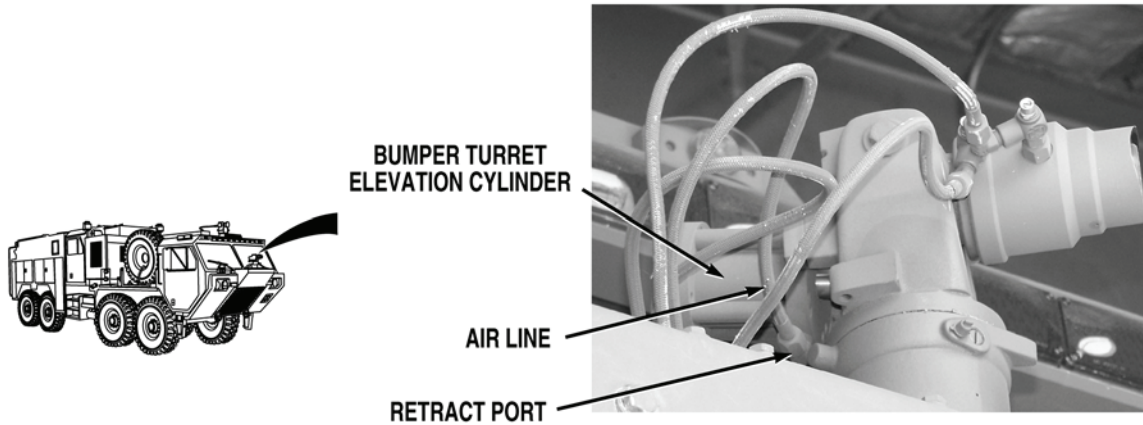
**MALFUNCTION****TEST OR INSPECTION****CORRECTIVE ACTION****WARNING**

- If air lines are under pressure when they are disconnected, they can whip around and cause injury to personnel. Caution should be exercised when disconnecting air line fittings.
- Air lines may be under pressure when control valve is operated. If under pressure and air lines are disconnected, air lines may whip around and cause injury to personnel. Caution should be exercised when operating control valve with air lines disconnected.

**NOTE**

Air pressure is checked by disconnecting air line at bumper turret elevation cylinder and observing air pressure escaping from air line when bumper turret control is activated.

- Step 56. Install bumper turret control cover and tighten four screws. Disconnect air line at bumper turret elevation cylinder retract port. While an assistant operates bumper turret control joystick to forward position (WP 0004), check if air pressure is present at bumper turret elevation cylinder retract port.

If air pressure is present, connect air line at bumper turret elevation cylinder retract port and go to Step 61.

MALFUNCTION	TEST OR INSPECTION	CORRECTIVE ACTION
-------------	--------------------	-------------------

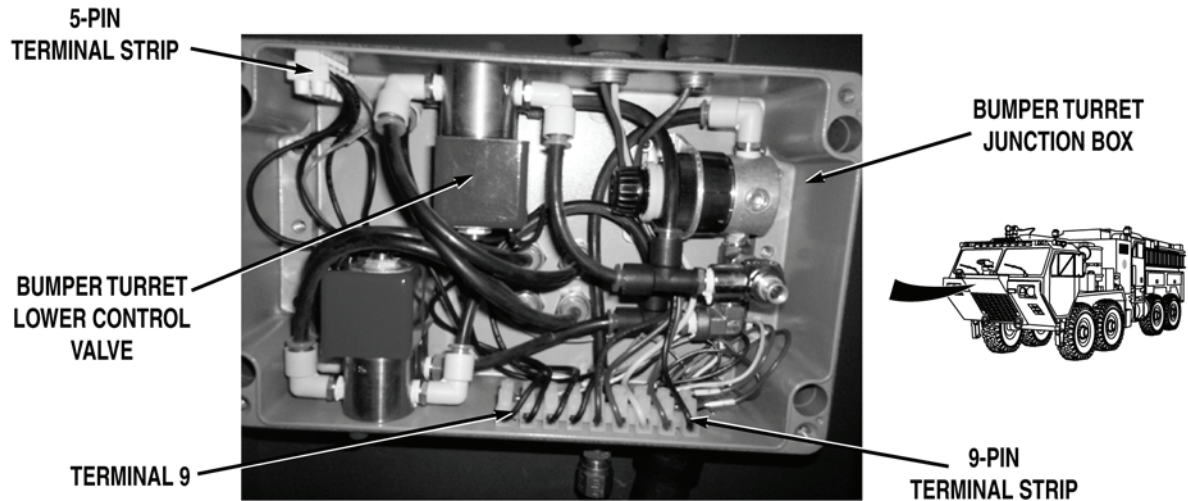
**WARNING**

Remove rings, wristwatches, neck chains, and any other jewelry before working around vehicle. Jewelry can catch on equipment and cause serious injury. Jewelry and tools may short across electrical circuits and cause damage to equipment, or severe burns or electrical shock to personnel.

Step 57. Connect air line at bumper turret elevation cylinder retract port. While an assistant operates bumper turret control joystick to forward position (WP 0004), check for 22 to 28 VDC between bumper turret lower wire (black) at bumper turret junction box 9-pin terminal strip, terminal 9 and a known good ground.

If 22 to 28 VDC are not present, go to Step 59.

Step 58. Put bumper turret control POWER switch to  $\bigcirc$  (off) position (WP 0004). Turn battery disconnect switch to OFF position (WP 0007). Check connections at bumper turret junction box 9-pin and 5-pin terminal strips for loose connections.

- If connections are loose, tighten loose connections (WP 0573).
- If connections are not loose, replace bumper turret lower control valve (WP 0573).

**MALFUNCTION**

**TEST OR INSPECTION**

**CORRECTIVE ACTION**

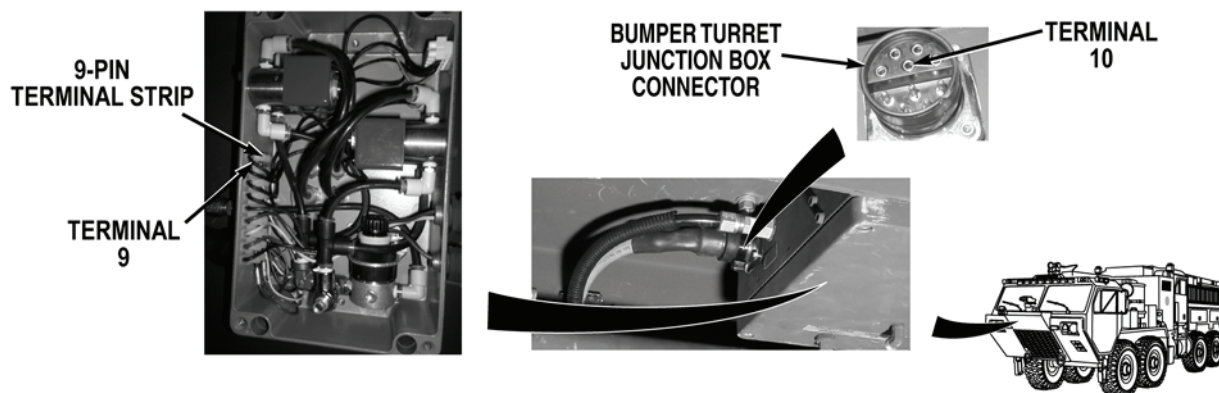

Step 59. Put bumper turret control POWER switch to  $\bigcirc$  (off) position (WP 0004). Turn battery disconnect switch to OFF position (WP 0007). Disconnect bumper turret wire harness bumper turret junction box connector. Check for continuity across bumper turret junction box lower wire (black) from bumper turret junction box connector, terminal 10 to bumper turret junction box 9-pin terminal strip, terminal 9.

If there is no continuity, repair bumper turret junction box lower wire in bumper turret junction box wire harness if repairable (TM 9-2320-325-14&P), or replace bumper turret junction box wire harness (WP 0573).

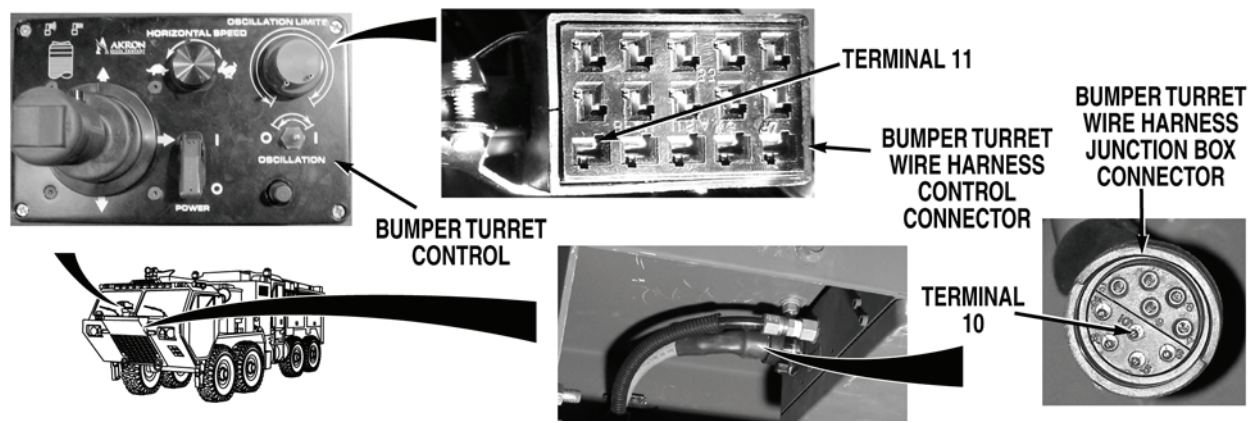

Step 60. Remove cab instrument panel E (WP 0311). Disconnect bumper turret wire harness bumper turret control connector. With a test lead set, check for continuity across bumper turret wire harness lower wire (black) from bumper turret wire harness bumper turret control connector, terminal 11 to bumper turret wire harness bumper turret junction box connector, terminal 10.

- a. If there is continuity, replace bumper turret control (WP 0570).
- b. If there is no continuity, repair bumper turret wire harness lower wire in bumper turret wire harness if repairable (TM 9-2320-325-14&P), or replace bumper turret wire harness (WP 0437).

---

**MALFUNCTION****TEST OR INSPECTION****CORRECTIVE ACTION**

---

**WARNING**

**Remove rings, wristwatches, neck chains, and any other jewelry before working around vehicle. Jewelry can catch on equipment and cause serious injury. Jewelry and tools may short across electrical circuits and cause damage to equipment, or severe burns or electrical shock to personnel.**

- Step 61. If installed, remove bumper turret junction box cover (WP 0572). Adjust bumper turret (WP 0188). Check if bumper turret elevation rate can be adjusted so elevation shifts to raised and lowered positions at a rate suitable for system operations.
- a. If bumper turret elevation shift rate adjusts to a rate suitable for system operations, fault corrected.
  - b. If bumper turret elevation shift rate cannot be adjusted, replace bumper turret junction box flow control valve (WP 0573).

**MALFUNCTION**

**TEST OR INSPECTION**

**CORRECTIVE ACTION**

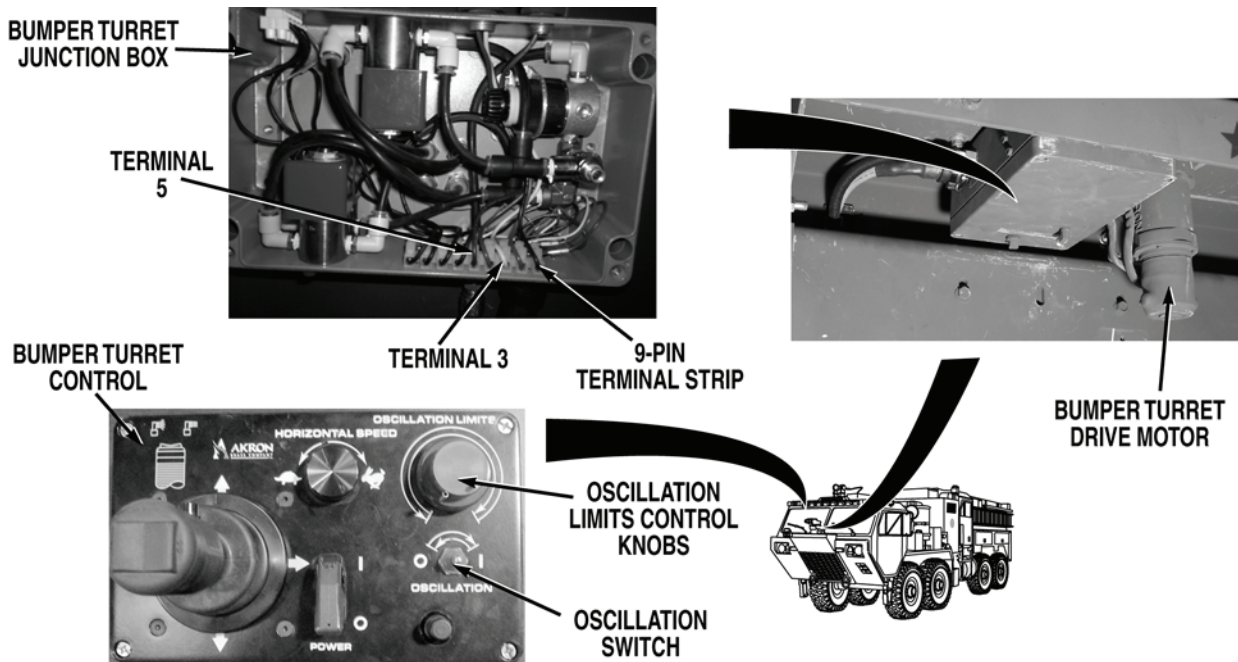

**WARNING**



**Remove rings, wristwatches, neck chains, and any other jewelry before working around vehicle. Jewelry can catch on equipment and cause serious injury. Jewelry and tools may short across electrical circuits and cause damage to equipment, or severe burns or electrical shock to personnel.**

Step 62. Put bumper turret control POWER switch to ○ (off) position (WP 0004). Turn battery disconnect switch to OFF position (WP 0007). Remove bumper turret junction box cover (WP 0572). Check for continuity across bumper turret position sensor ground wire (blue) from bumper turret junction box 9-pin terminal strip, terminal 5 to a known good ground.

If there is no continuity, go to Step 69.

Step 63. Turn battery disconnect switch to ON position (WP 0007). Put bumper turret control POWER switch to | (on) position. Put OSCILLATION switch to | (on) position (WP 0004). Set OSCILLATION LIMITS control knobs to maximum left and right limits (WP 0004). Check for 7 to 9 VDC between bumper turret position sensor power wire (yellow) at bumper turret junction box 9-pin terminal strip, terminal 3 and a known good ground.

If 7 to 9 VDC are not present, go to Step 67.

**MALFUNCTION**  
**TEST OR INSPECTION**  
**CORRECTIVE ACTION**

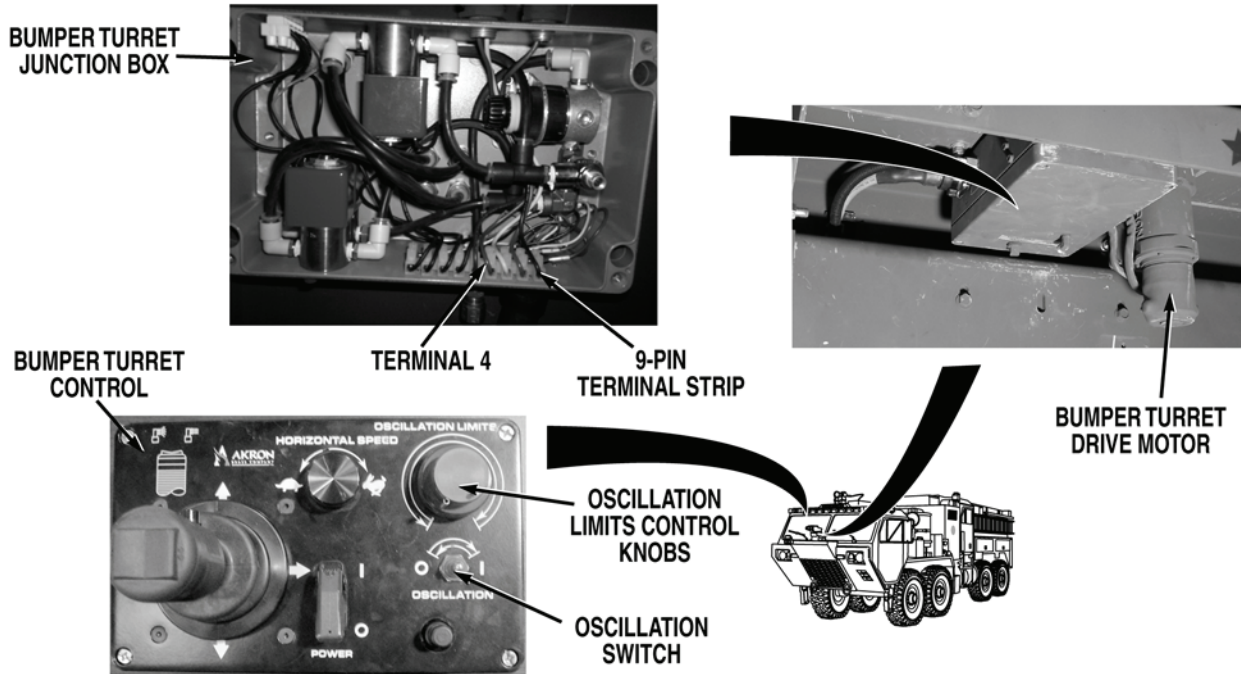

**NOTE**

Voltage in Step 64 will vary between 0 and 7 VDC as bumper turret rotates from left limit to right limit and right limit to left limit.

- Step 64. Check if voltage is between 0 to 7 VDC between bumper turret position sensor signal wire (green) at bumper turret junction box 9-pin terminal strip, terminal 4 and a known good ground as bumper turret rotates.

If 0 to 7 VDC are not present, replace bumper turret drive motor (WP 0571).

**MALFUNCTION**

**TEST OR INSPECTION**

**CORRECTIVE ACTION**

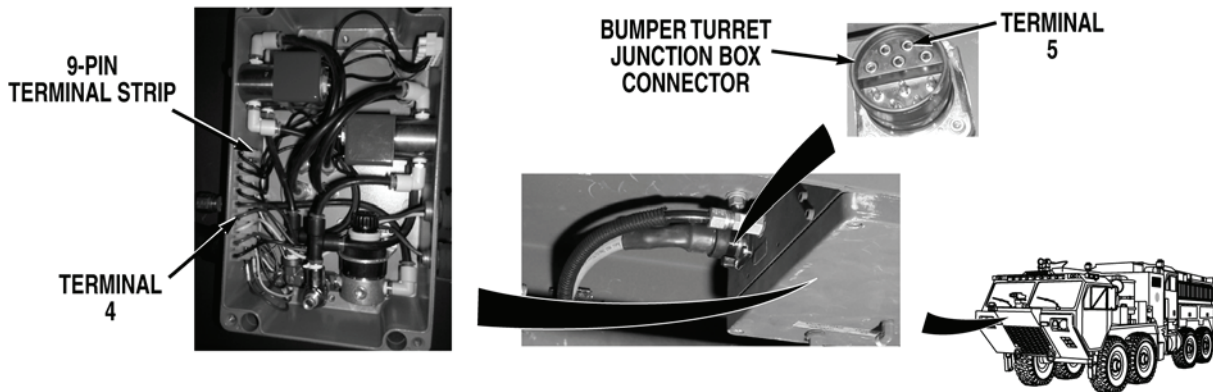

Step 65. Put bumper turret control POWER switch to  $\bigcirc$  (off) position (WP 0004). Turn battery disconnect switch to OFF position (WP 0007). Disconnect bumper turret wire harness bumper turret junction box connector. Check for continuity across bumper turret junction box position sensor signal wire (green) from bumper turret junction box connector, terminal 5 to bumper turret junction box 9-pin terminal strip, terminal 4.

If there is no continuity, repair bumper turret junction box position sensor signal wire in bumper turret junction box wire harness if repairable (TM 9-2320-325-14&P), or replace bumper turret junction box wire harness (WP 0573).

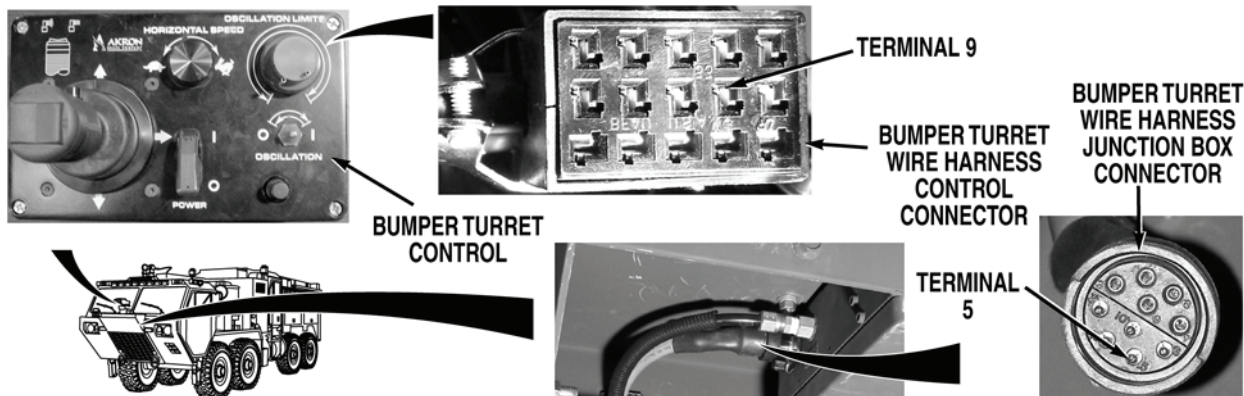

Step 66. Remove cab instrument panel E (WP 0311). Disconnect bumper turret wire harness bumper turret control connector. With a test lead set, check for continuity across bumper turret wire harness position sensor signal wire (green) from bumper turret wire harness bumper turret control connector, terminal 9 to bumper turret wire harness bumper turret junction box connector, terminal 5.

- a. If there is continuity, replace bumper turret control (WP 0570).
- b. If there is no continuity, repair bumper turret wire harness position sensor signal wire in bumper turret wire harness if repairable (TM 9-2320-325-14&P), or replace bumper turret wire harness (WP 0437).



**MALFUNCTION**  
**TEST OR INSPECTION**  
**CORRECTIVE ACTION**

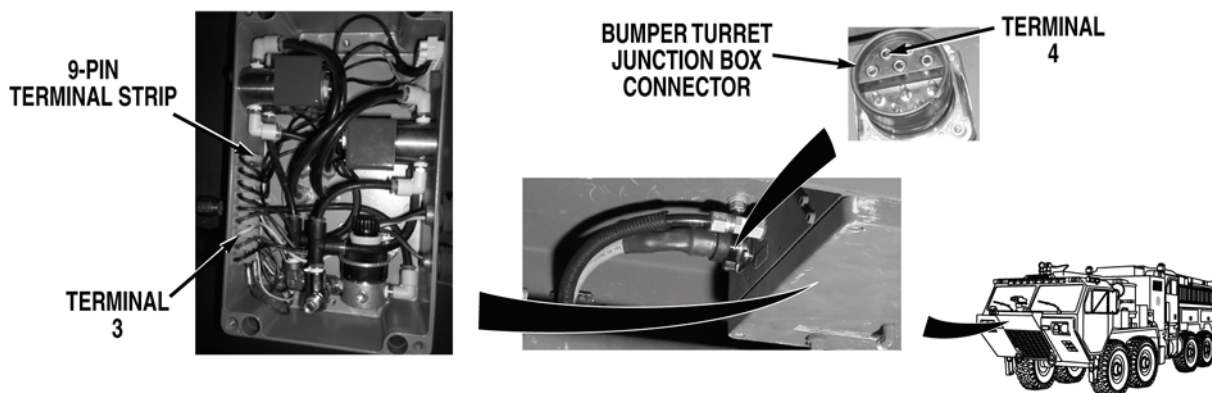

Step 67. Put bumper turret control POWER switch to  $\bigcirc$  (off) position (WP 0004). Turn battery disconnect switch to OFF position (WP 0007). Disconnect bumper turret wire harness bumper turret junction box connector. Check for continuity across bumper turret junction box position sensor power wire (yellow) from bumper turret junction box connector, terminal 4 to bumper turret junction box 9-pin terminal strip, terminal 3.

If there is no continuity, repair bumper turret junction box position sensor power wire in bumper turret junction box wire harness if repairable (TM 9-2320-325-14&P), or replace bumper turret junction box wire harness (WP 0573).

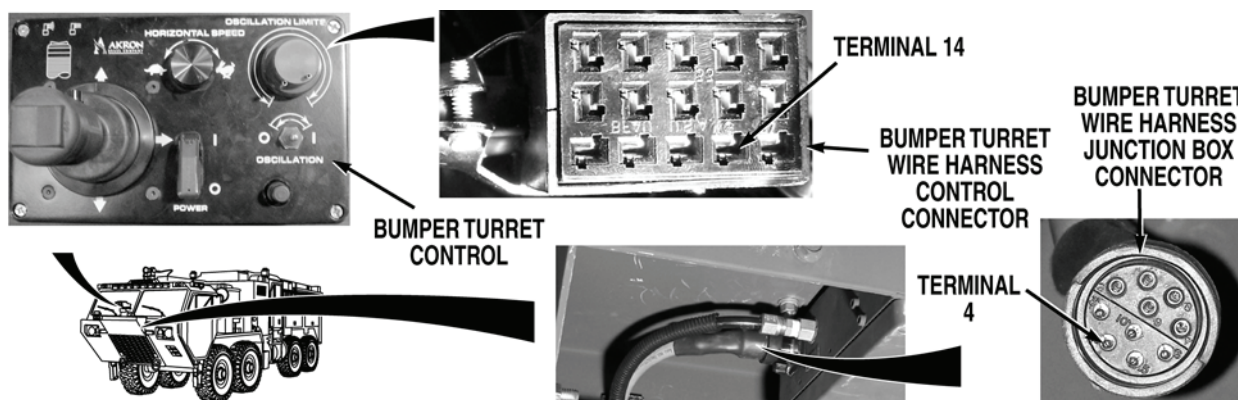

Step 68. Remove cab instrument panel E (WP 0311). Disconnect bumper turret wire harness bumper turret control connector. With a test lead set, check for continuity across bumper turret wire harness position sensor power wire (yellow) from bumper turret wire harness bumper turret control connector, terminal 14 to bumper turret wire harness bumper turret junction box connector, terminal 4.

- a. If there is continuity, replace bumper turret control (WP 0570).
- b. If there is no continuity, repair bumper turret wire harness position sensor power wire in bumper turret wire harness if repairable (TM 9-2320-325-14&P), or replace bumper turret wire harness (WP 0437).

**MALFUNCTION**

**TEST OR INSPECTION**

**CORRECTIVE ACTION**

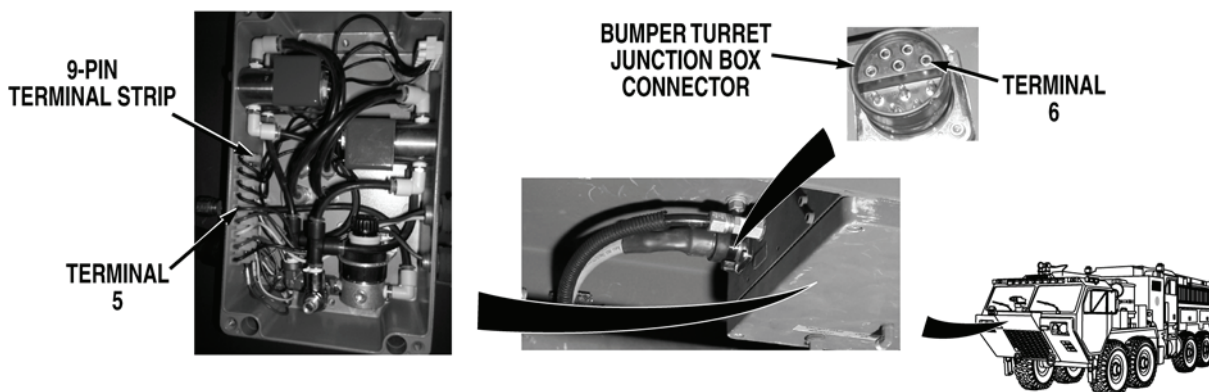

Step 69. Disconnect bumper turret wire harness bumper turret junction box connector. Check for continuity across bumper turret junction box position sensor ground wire (blue) from bumper turret junction box connector, terminal 6 to bumper turret junction box 9-pin terminal strip, terminal 5.

If there is no continuity, repair bumper turret junction box position sensor ground wire in bumper turret junction box wire harness if repairable (TM 9-2320-325-14&P), or replace bumper turret junction box wire harness (WP 0573).

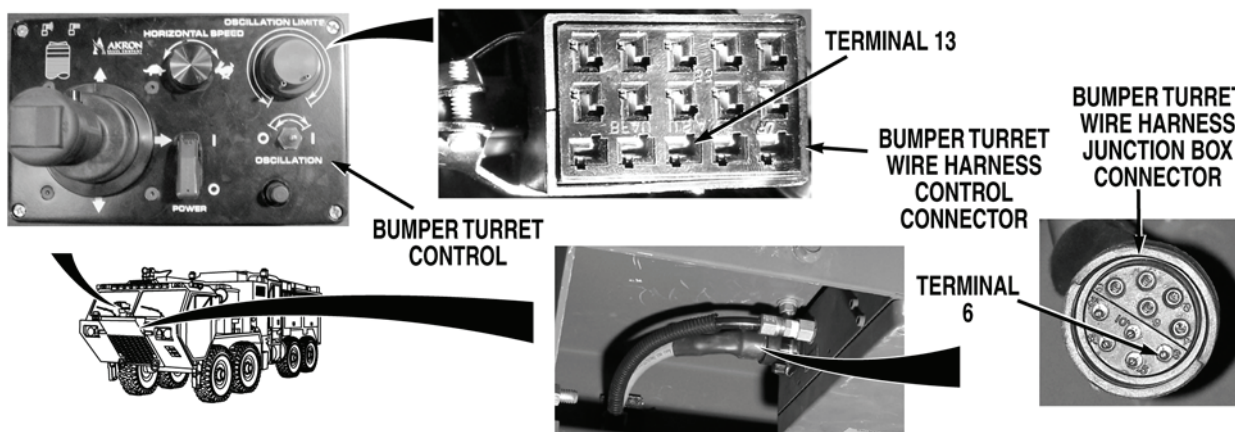

Step 70. Remove cab instrument panel E (WP 0311). Disconnect bumper turret wire harness bumper turret control connector. With a test lead set, check for continuity across bumper turret wire harness position sensor ground wire (blue) from bumper turret wire harness bumper turret control connector, terminal 13 to bumper turret wire harness bumper turret junction box connector, terminal 6.

- a. If there is continuity, replace bumper turret control (WP 0570).
- b. If there is no continuity, repair bumper turret wire harness position sensor ground wire in bumper turret wire harness if repairable (TM 9-2320-325-14&P), or replace bumper turret wire harness (WP 0437).

**MALFUNCTION**  
**TEST OR INSPECTION**  
**CORRECTIVE ACTION**

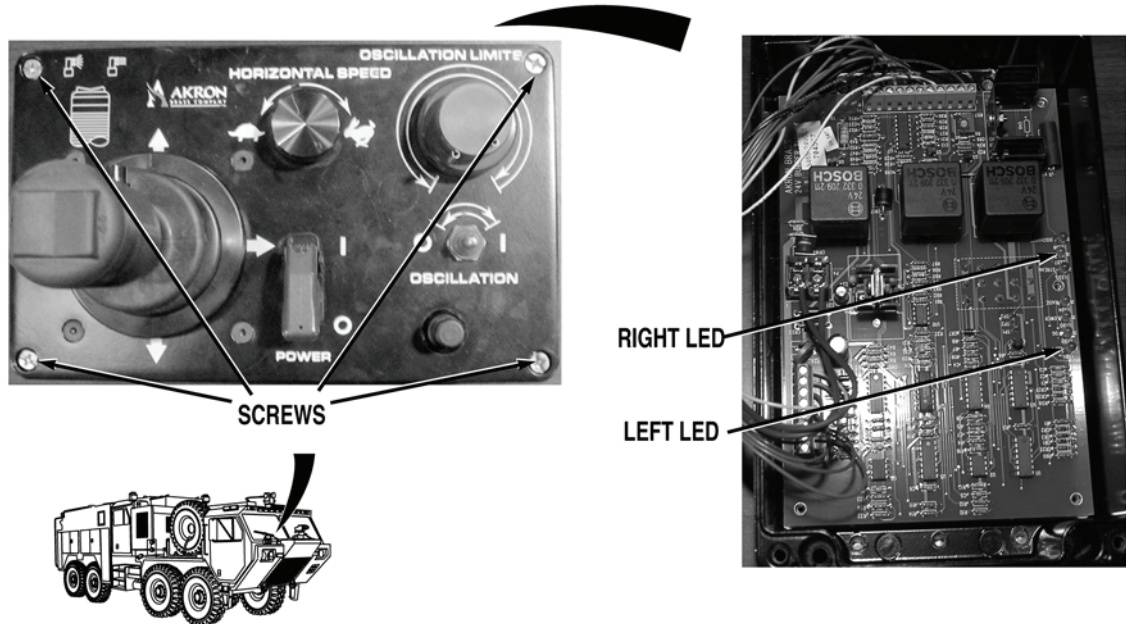

**WARNING**



**Remove rings, wristwatches, neck chains, and any other jewelry before working around vehicle. Jewelry can catch on equipment and cause serious injury. Jewelry and tools may short across electrical circuits and cause damage to equipment, or severe burns or electrical shock to personnel.**

Step 71. Turn battery disconnect switch to OFF position (WP 0007). Loosen four screws and remove bumper turret control cover. Turn battery disconnect switch to ON position (WP 0007). Do not disconnect wires. While operating bumper turret control joystick to right (passenger side) position (WP 0004), check if bumper turret control RIGHT LED illuminates.

If bumper turret control RIGHT LED does not illuminate, replace bumper turret control (WP 0570).

Step 72. While operating bumper turret control joystick to left (driver side) position (WP 0004), check if bumper turret control LEFT LED illuminates.

If bumper turret control LEFT LED does not illuminate, replace bumper turret control (WP 0570).

**MALFUNCTION**

**TEST OR INSPECTION**

**CORRECTIVE ACTION**

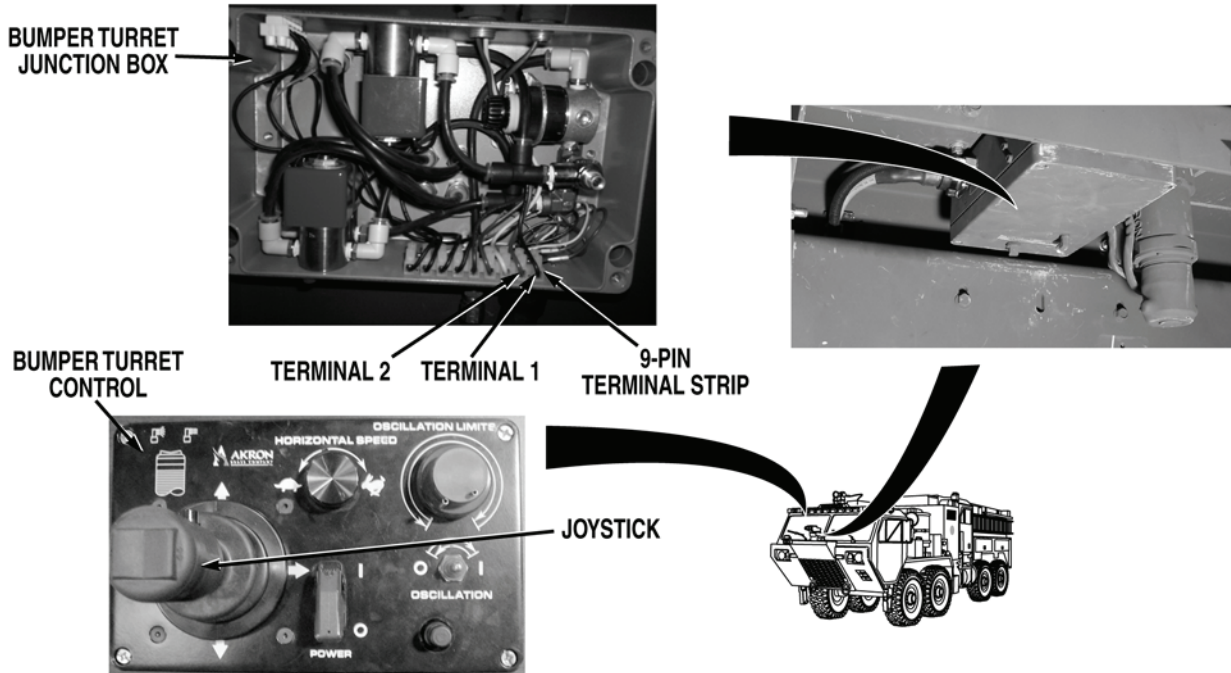

**NOTE**

Voltage while performing Step 73 will switch from negative VDC to VDC when bumper turret control is in oscillation. This is normal operation.

Step 73. Turn battery disconnect switch to OFF position (WP 0007). Install bumper turret control cover and tighten four screws. Remove bumper turret junction box cover (WP 0573). Disconnect bumper turret motor power wire (red) from bumper turret junction box 9-pin terminal strip (WP 0573). Turn battery disconnect switch to ON position (WP 0007). Put bumper turret control oscillation switch to on position (WP 0004). Check for 22 to 28 VDC between bumper turret motor power wire (red) at bumper turret motor power wire (black) at bumper turret junction box 9-pin terminal strip, terminal 1 to terminal 2.

If there is 22 to 28 VDC, go to Step 78.

**MALFUNCTION**  
**TEST OR INSPECTION**  
**CORRECTIVE ACTION**

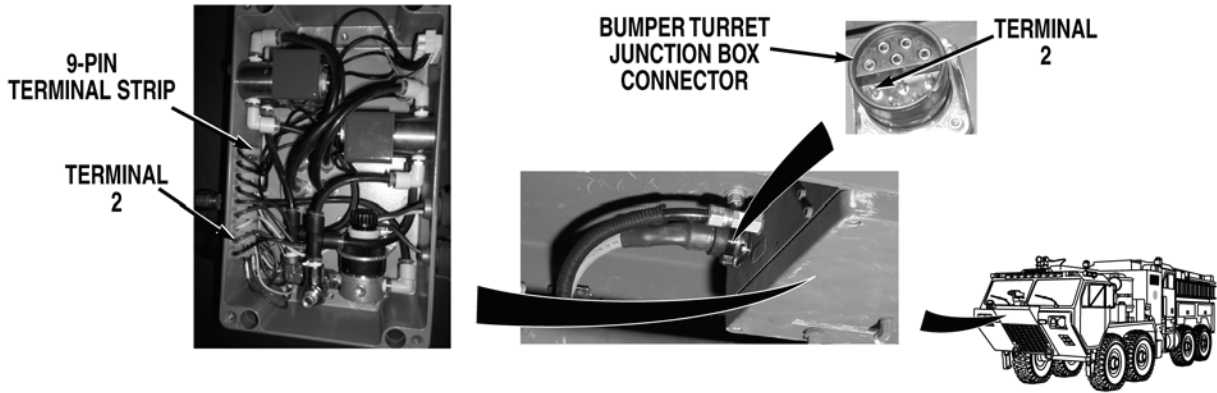

Step 74. Put bumper turret control POWER switch to ○ (off) position (WP 0004). Turn battery disconnect switch to OFF position (WP 0007). Disconnect bumper turret wire harness bumper turret junction box connector. With a test lead set, check for continuity across bumper turret junction box motor power wire (red) from bumper turret junction box connector, terminal 2 to bumper turret junction box 9-pin terminal strip, terminal 2.

If there is no continuity, repair bumper turret junction box motor power wire (red) in bumper turret junction box wire harness if repairable (TM 9-2320-325-14&P), or replace bumper turret junction box wire harness (WP 0573).

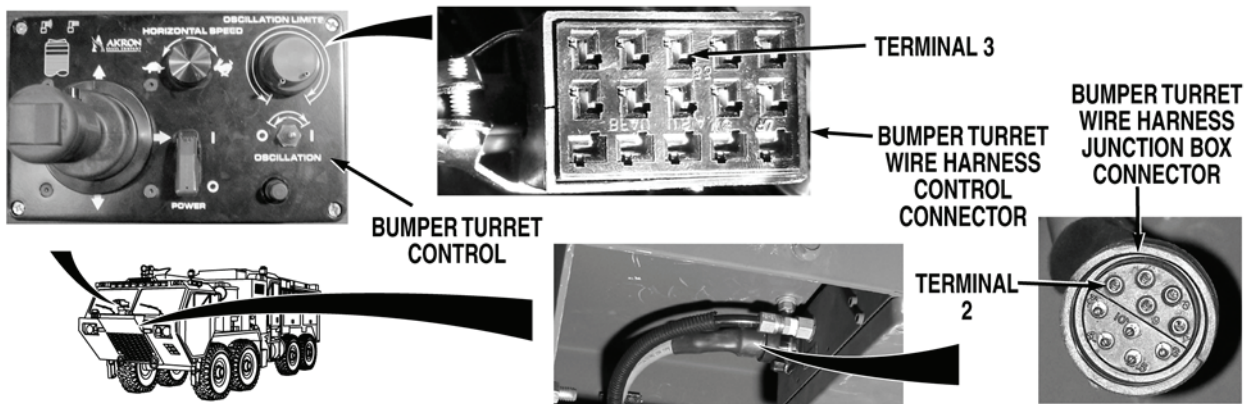

Step 75. Remove cab instrument panel E (WP 0311). With a test lead set, check for continuity across bumper turret wire harness motor power wire (red) from bumper turret wire harness bumper turret control connector, terminal 3 to bumper turret wire harness bumper turret junction box connector, terminal 2.

If there is no continuity, repair bumper turret wire harness motor power wire (red) in bumper turret wire harness if repairable (TM 9-2320-325-14&P), or replace bumper turret wire harness (WP 0437).

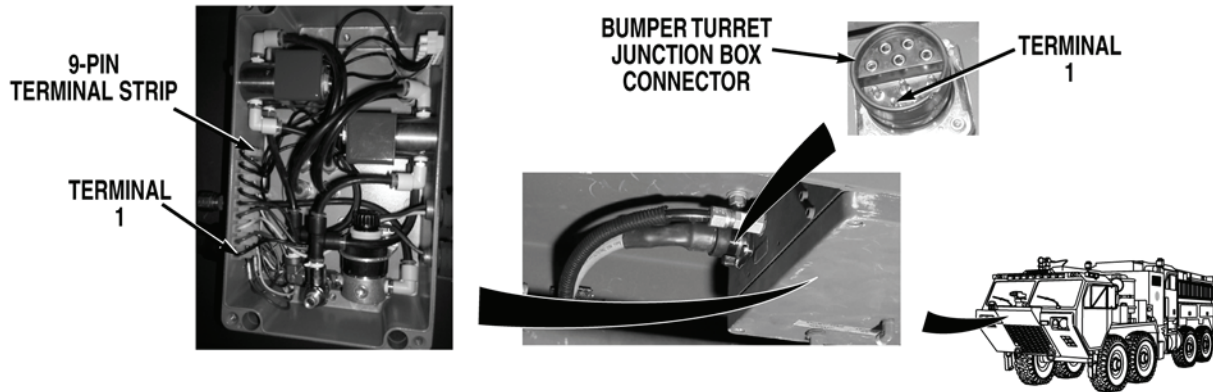
**MALFUNCTION****TEST OR INSPECTION****CORRECTIVE ACTION**

- Step 76. With a test lead set, check for continuity across bumper turret junction box motor power wire (black) from bumper turret junction box connector, terminal 1 to bumper turret junction box 9-pin terminal strip, terminal 1.

If there is no continuity, repair bumper turret junction box motor power wire (black) in bumper turret junction box wire harness if repairable (TM 9-2320-325-14&P), or replace bumper turret junction box wire harness (WP 0573).

## MALFUNCTION

## TEST OR INSPECTION

## CORRECTIVE ACTION

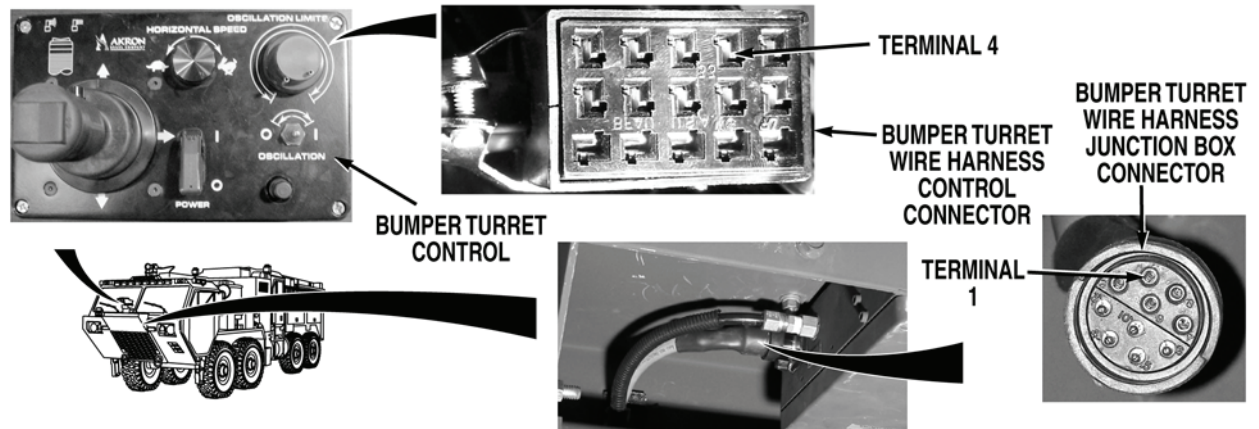

Step 77. With a test lead set, check for continuity across bumper turret wire harness motor power wire (black) from bumper turret wire harness bumper turret control connector, terminal 4 to bumper turret wire harness bumper turret junction box connector, terminal 1.

- a. If there is continuity, replace bumper turret control (WP 0570).
- b. If there is no continuity, repair bumper turret wire harness motor power wire (black) in bumper turret wire harness if repairable (TM 9-2320-325-14&P), or replace bumper turret wire harness (WP 0437).

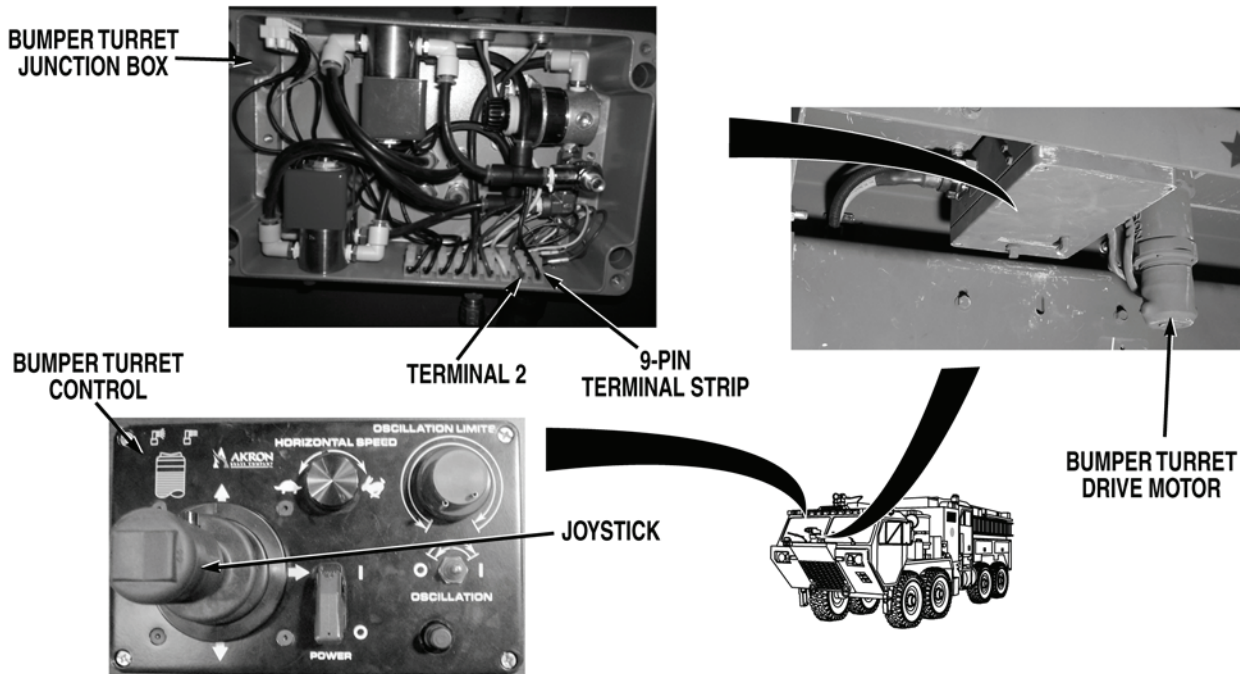
**MALFUNCTION****TEST OR INSPECTION****CORRECTIVE ACTION**

- Step 78. Check for 0.5 to 1 amp nominally through bumper turret motor power wire (red) from bumper turret junction box 9-pin terminal strip, terminal 2 to bumper turret motor wire (red) termination which was disconnected in Step 73.
- If there is less than 0.5 amp through bumper turret motor power wire (red), replace bumper turret motor (WP 0571).
  - If there is greater than 1 amp through bumper turret motor power wire (red), replace bumper turret (WP 0569).

**END OF TASK****FOLLOW-ON MAINTENANCE**

Remove wheel chocks (TM 9-2320-347-10)

**END OF TASK****END OF WORK PACKAGE**



**FIELD LEVEL MAINTENANCE**

**DIRECT TANK FILL VALVE DOES NOT OPERATE PROPERLY (AUTO OR MANUAL MODE)**

**INITIAL SETUP:**

**Tools and Special Tools**

Lead Set, Test (WP 0622, Item 21)  
 Tool Kit, General Mechanic's: Automotive  
 (WP 0622, Item 27)

**Personnel Required**

MOS 63B Wheeled vehicle mechanic (2)

**References**

TM 9-2320-325-14&P  
 WP 0004  
 WP 0007  
 WP 0123  
 WP 0303  
 WP 0540  
 WP 0325  
 WP 0337  
 WP 0339

**References (continued)**

WP 0412  
 WP 0413  
 WP 0418  
 WP 0441  
 WP 0447  
 WP 0457  
 WP 0458  
 WP 0459  
 WP 0499  
 WP 0463

**Equipment Conditions**

Water pump engine OFF (WP 0022)  
 Engine OFF (TM 9-2320-347-10)  
 Wheels chocked (TM 9-2320-347-10)

**MALFUNCTION**

**TEST OR INSPECTION**

**CORRECTIVE ACTION**

**DIRECT TANK FILL VALVE DOES NOT OPERATE PROPERLY (AUTO OR MANUAL MODE)**

**NOTE**

- Ensure cap is installed tightly on DIRECT TANK FILL during this procedure, or connect hose to DIRECT TANK FILL connector to drain water into appropriate container or to ground. If direct tank fill valve opens during this procedure, water will discharge from tank uncontrolled.
- Do not engage water pump engine during this procedure. Valve operation can be checked without pump operation.
- Valve operations can be checked by observing valve shaft rotation.
- If it is known that direct tank fill valve operates properly in manual mode, go to Step 2.

**MALFUNCTION**

**TEST OR INSPECTION**

**CORRECTIVE ACTION**

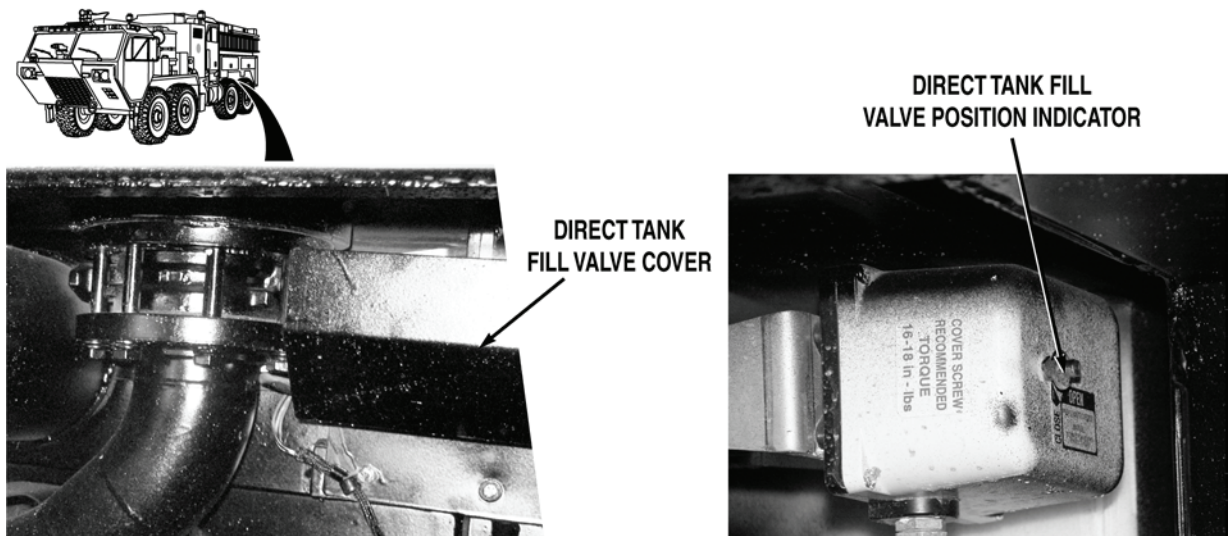

Step 1. Remove direct tank fill valve cover (WP 0303). Turn battery disconnect switch to ON position (WP 0007). While an assistant puts pump operator's panel DIRECT TANK FILL switch to OPEN position (WP 0004) check if direct tank fill valve operates to open position.

If direct tank fill valve does not operate to open position, go to Step 24.

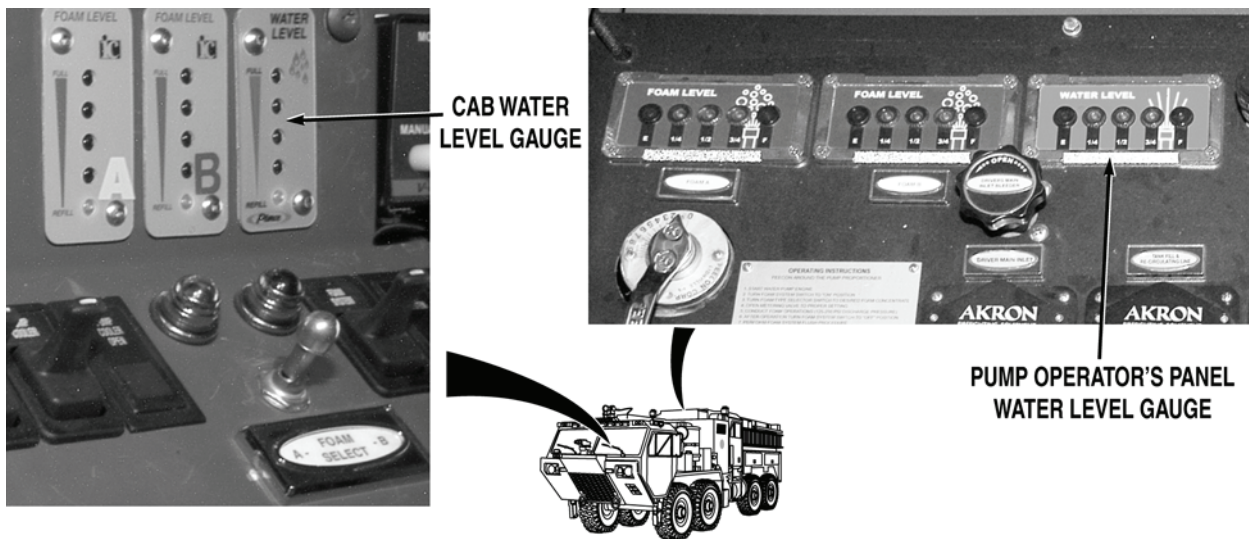

Step 2. Put pump operator's panel DIRECT TANK FILL switch to OFF position (WP 0004). With water tank full, check if pump operator's panel and cab WATER LEVEL gauges indicate FULL (WP 0004).

If pump operator's panel and cab WATER LEVEL gauges are not operating properly, troubleshoot Water Tank Level Indicator Gauge Does Not Operate Properly (WP 0123)

**MALFUNCTION**  
**TEST OR INSPECTION**  
**CORRECTIVE ACTION**



**CAB WATER LEVEL  
 GAUGE WIRE HARNESS**

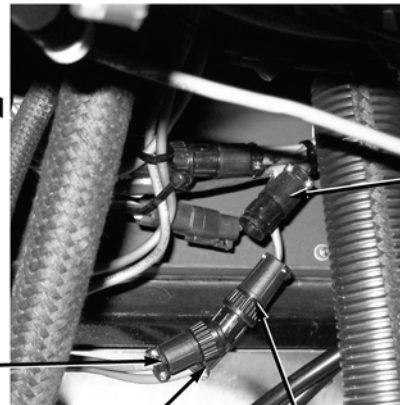

**WATER LEVEL GAUGE  
 AUTO FILL CONTROL  
 WIRE HARNESS**

**WATER LEVEL GAUGE  
 AUTO FILL CONTROL  
 WIRE HARNESS**

**CAB WATER LEVEL  
 GAUGE WIRE HARNESS**

**WARNING**



**Remove rings, wristwatches, neck chains, and any other jewelry before working around vehicle. Jewelry can catch on equipment and cause serious injury. Jewelry and tools may short across electrical circuits and cause damage to equipment, or severe burns or electrical shock to personnel.**

- Step 3. Open pump operator's panel housing (WP 0325). Swap pump operator's panel WATER LEVEL gauge auto tank fill control and cab water level gauge wire harness connectors. Check if cab WATER LEVEL gauge indicates FULL (WP 0004).

If cab WATER LEVEL gauge does not indicate FULL, replace pump operator's panel WATER LEVEL gauge (WP 0339).

**MALFUNCTION**

**TEST OR INSPECTION**

**CORRECTIVE ACTION**

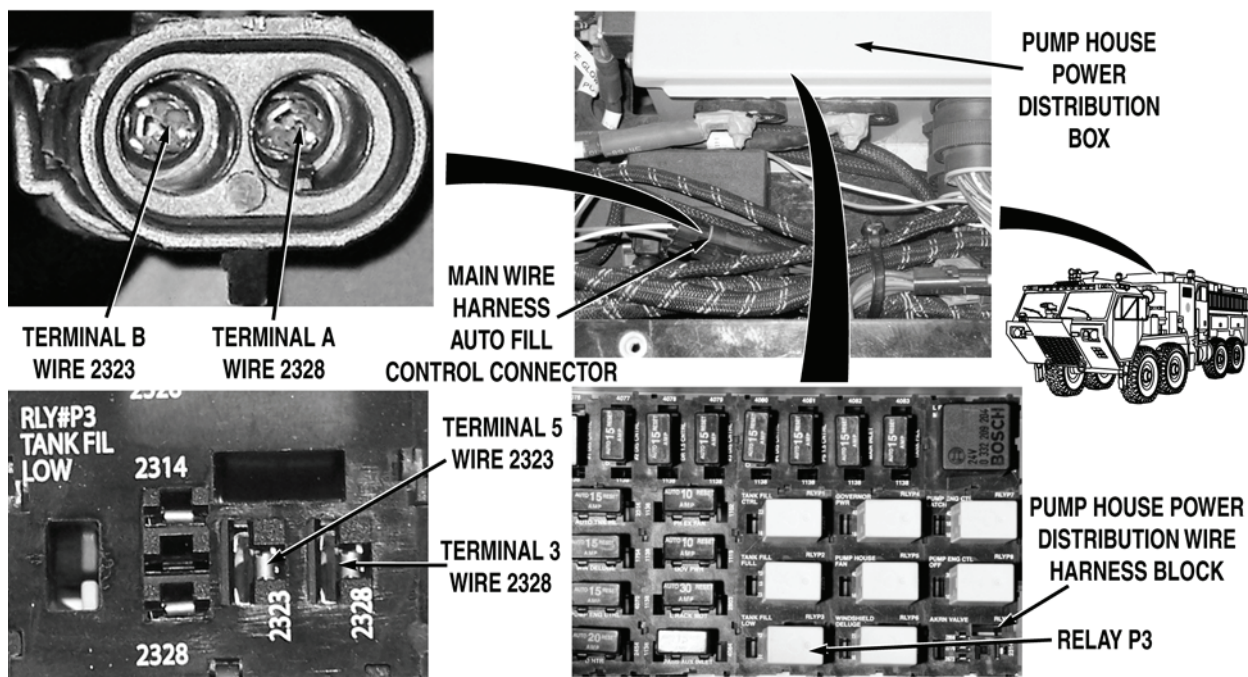

**NOTE**

Mark all relays before removing. Do not install relays except when instructed to do so in procedure.

- Step 4. Turn battery disconnect switch to OFF position (WP 0007). Reconnect auto fill control wire harness to direct tank fill auto fill controller connector. Remove pump panel S (WP 0540). Open pump house power distribution box (WP 0413). Remove relay P3 (WP 0413). Disconnect main wire harness auto tank fill controller connector. With a test lead set, check for continuity across wire 2328 (green) from pump house power distribution wire harness relay P3 connector, terminal 3 to main wire harness auto tank fill controller connector, terminal A.

If there is no continuity, go to Step 23.

- Step 5. With a test lead set, check for continuity across wire 2323 (brown) from pump house power distribution wire harness block relay P3 connector, terminal 5 to main wire harness auto tank fill controller connector, terminal B.

If there is no continuity, go to Step 22.

**MALFUNCTION**  
**TEST OR INSPECTION**  
**CORRECTIVE ACTION**

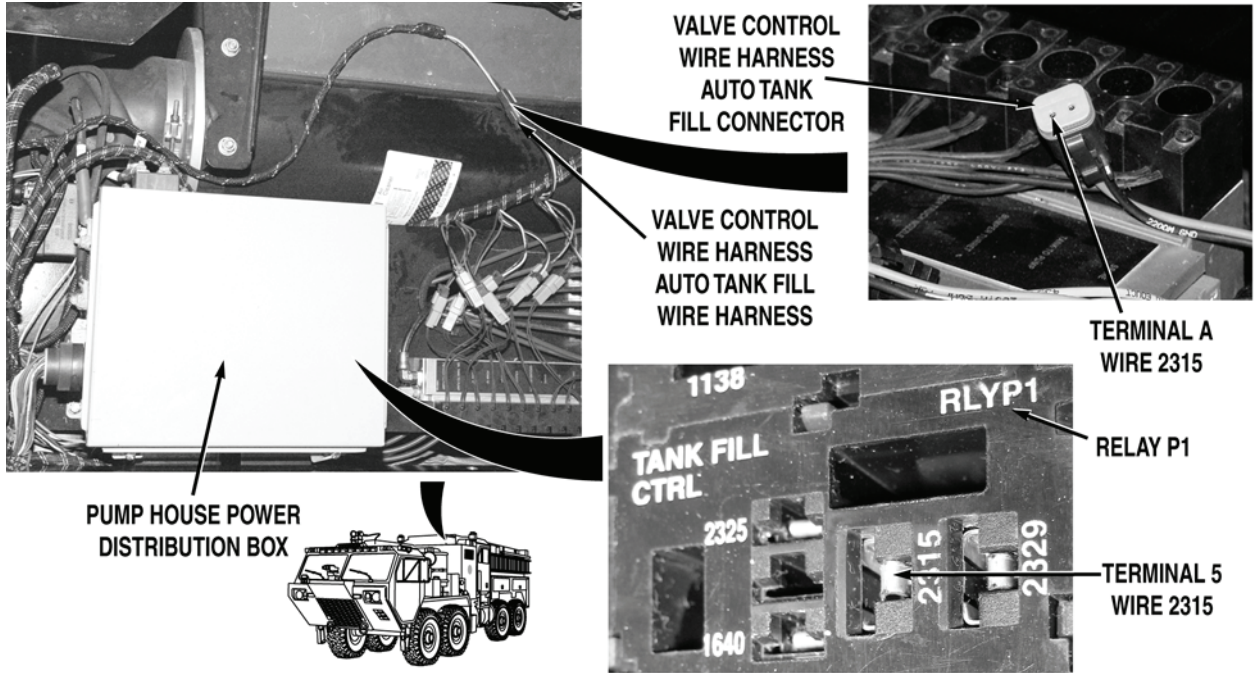

Step 6. Remove relay P1 (WP 0413). Disconnect valve control wire harness auto tank fill connector. With a test lead set, check for continuity across wire 2315 (yellow) from pump house power distribution wire harness relay P1 connector, terminal 5, to valve control wire harness auto tank fill connector, terminal A.

If there is no continuity, go to Step 21.

**MALFUNCTION**

**TEST OR INSPECTION**

**CORRECTIVE ACTION**

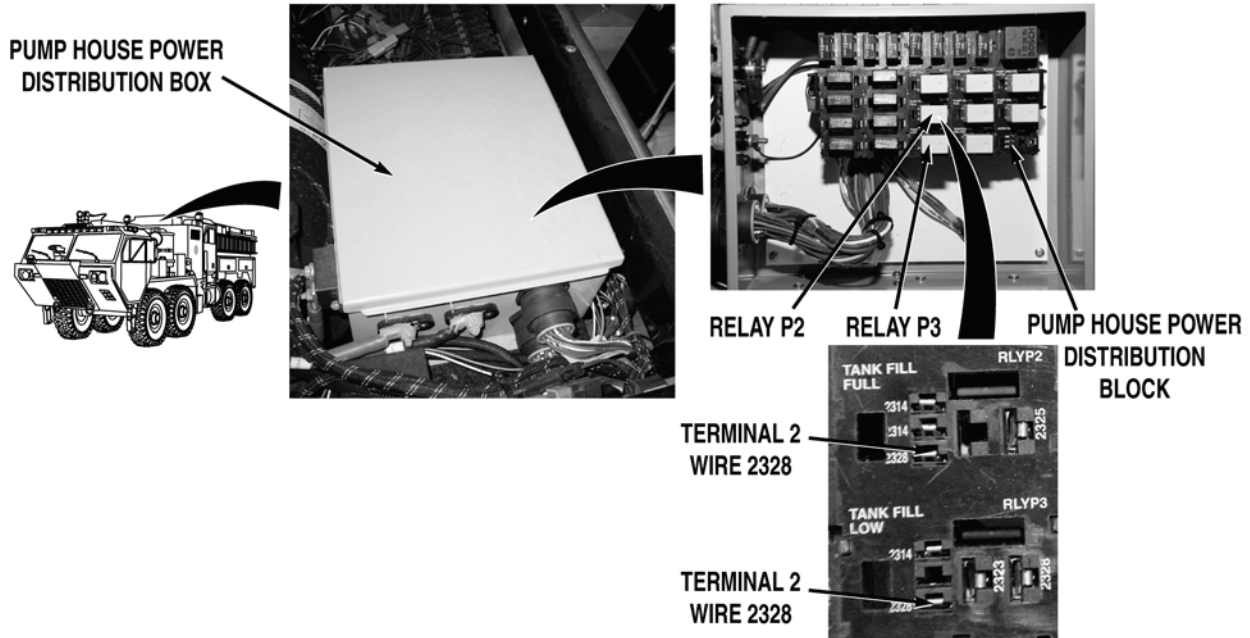

Step 7. Remove relay P2 (WP 0413). With a test lead set, check for continuity across pump house power distribution wire harness wire 2328 (green) from relay P2 connector, terminal 2 to relay P3 connector, terminal 2.

If there is no continuity, replace pump house power distribution wire harness and block (WP 0457).

**MALFUNCTION**  
**TEST OR INSPECTION**  
**CORRECTIVE ACTION**

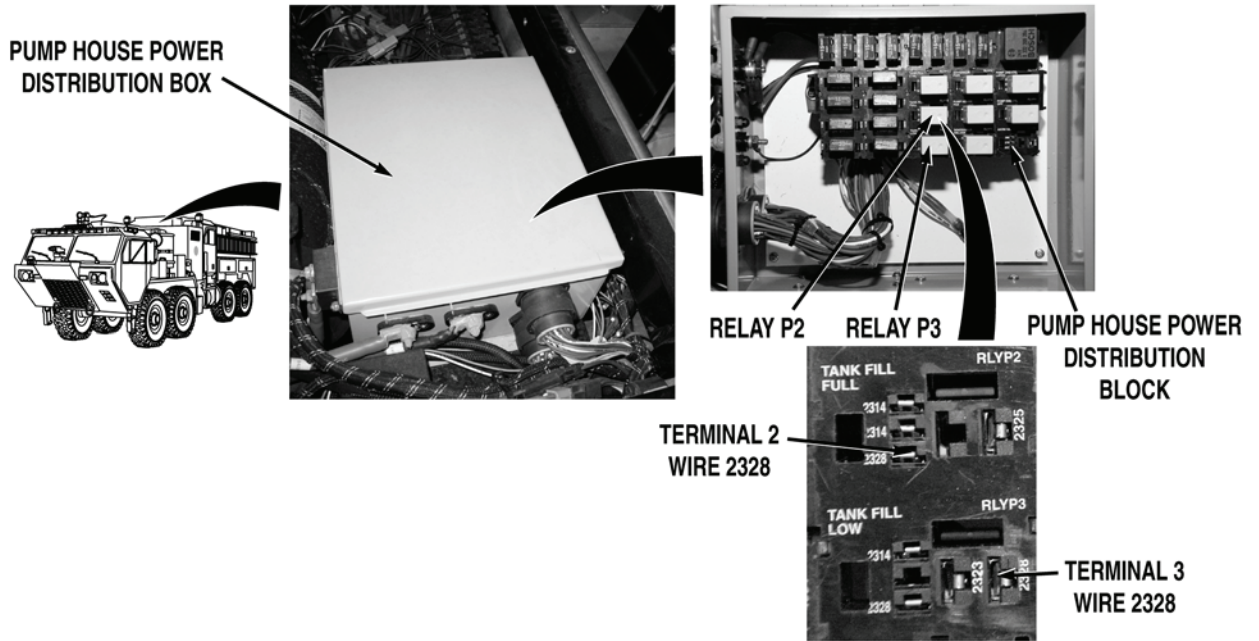

Step 8. With a test lead set, check for continuity across pump house power distribution wire harness wire 2328 (green) from relay P2 connector, terminal 2 to relay P3 connector, terminal 3.

If there is no continuity, replace pump house power distribution wire harness and block (WP 0457).

**MALFUNCTION**

**TEST OR INSPECTION**

**CORRECTIVE ACTION**

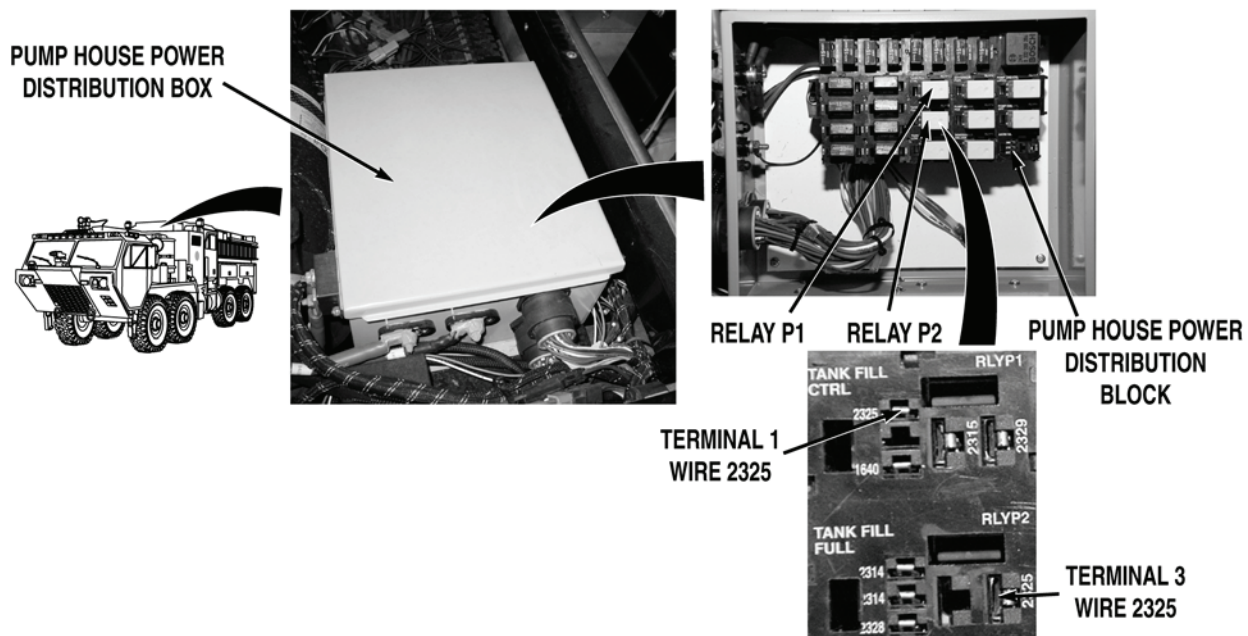

Step 9. With a test lead set, check for continuity across pump house power distribution wire harness wire 2325 (black) from relay P2 connector, terminal 3 to relay P1 connector, terminal 1.

If there is no continuity, replace pump house power distribution wire harness and block (WP 0457).



**MALFUNCTION**  
**TEST OR INSPECTION**  
**CORRECTIVE ACTION**

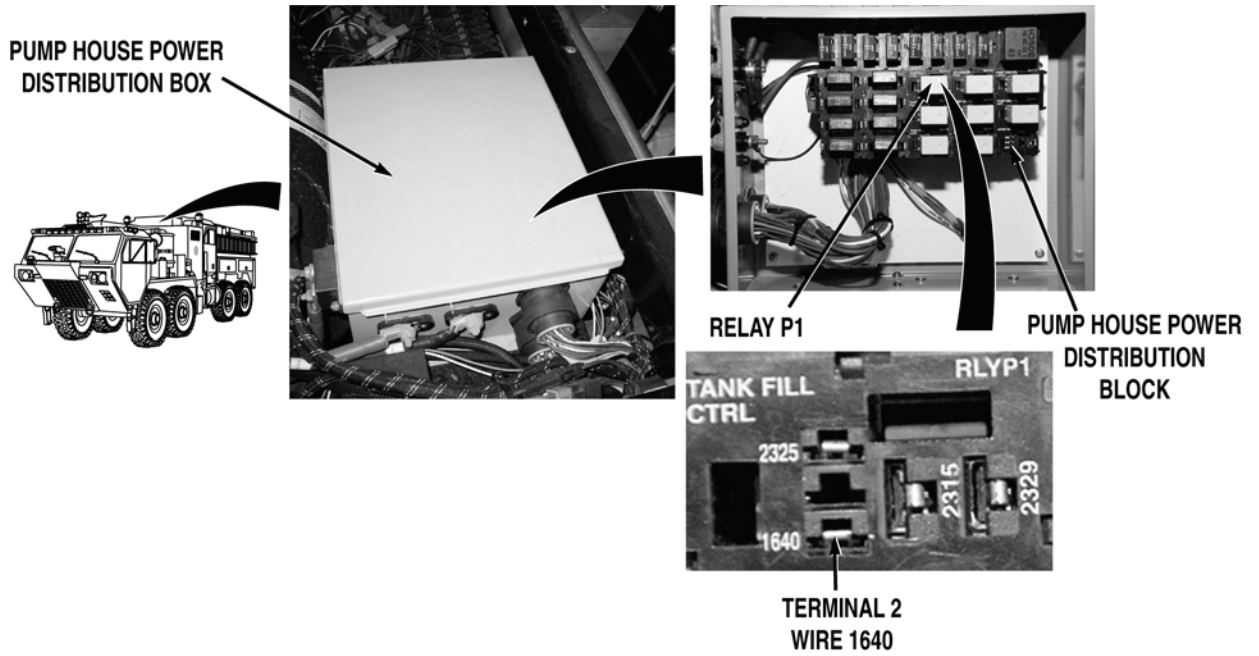

Step 10. With a test lead set, check for continuity across pump house power distribution wire harness wire 1640 (black) from relay P1 connector, terminal 2 to a known good ground.

If there is no continuity, replace pump house power distribution wire harness and block (WP 0457).

**MALFUNCTION**

**TEST OR INSPECTION**

**CORRECTIVE ACTION**

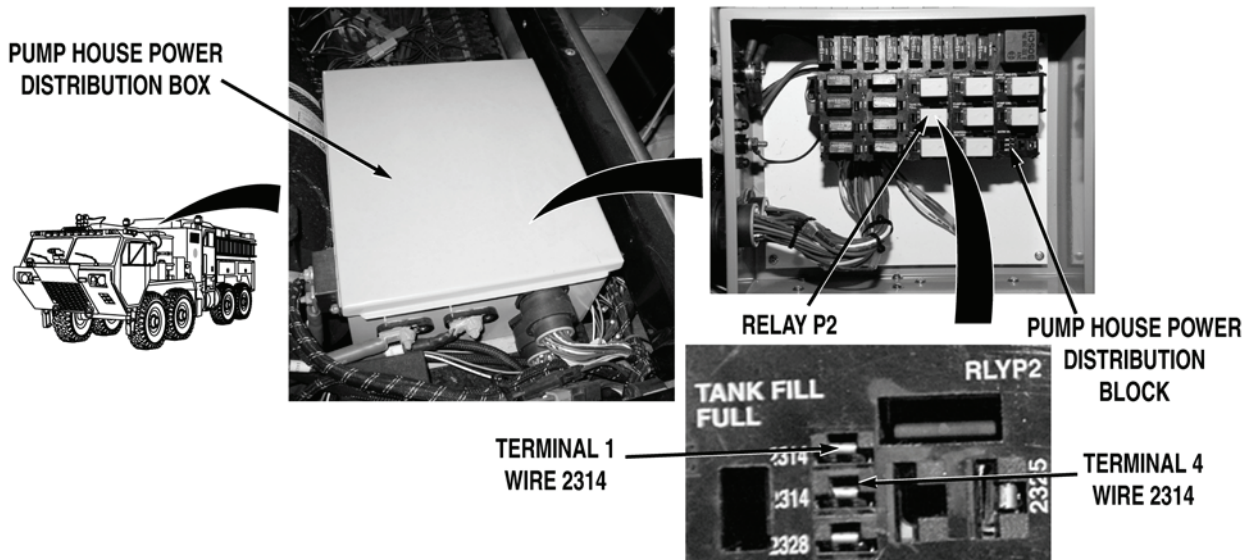

Step 11. Turn battery disconnect switch to ON position (WP 0007). With a test lead set, check for 22 to 28 VDC between pump house power distribution wire harness wire 2314 (red) at relay P2 connector, terminal 1 and a known good ground.

If 22 to 28 VDC are not present, replace pump house power distribution wire harness and block (WP 0457).

Step 12. With a test lead set, check for 22 to 28 VDC between pump house power distribution wire harness wire 2314 (red) at relay P2 connector, terminal 4 and a known good ground.

If 22 to 28 VDC are not present, replace pump house power distribution wire harness and block (WP 0457).

---

**MALFUNCTION**  
**TEST OR INSPECTION**  
**CORRECTIVE ACTION**

---

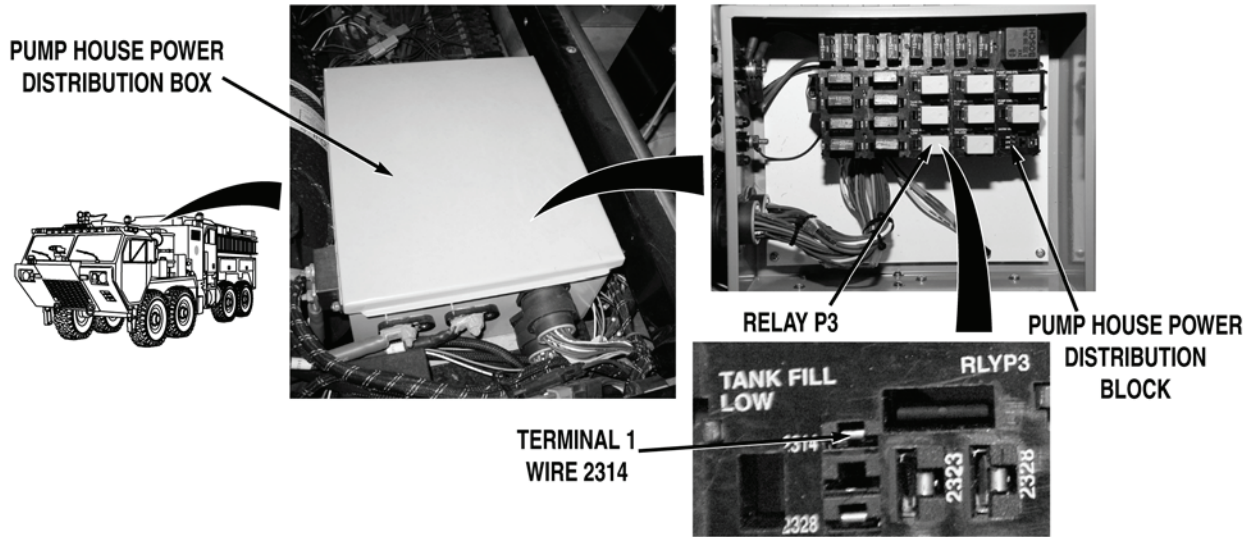

Step 13. With a test lead set, check for 22 to 28 VDC between pump house power distribution wire harness wire 2314 (red) at relay P3 connector, terminal 1 and a known good ground.

If 22 to 28 VDC are not present, replace pump house power distribution wire harness and block (WP 0457).

**MALFUNCTION**

**TEST OR INSPECTION**

**CORRECTIVE ACTION**

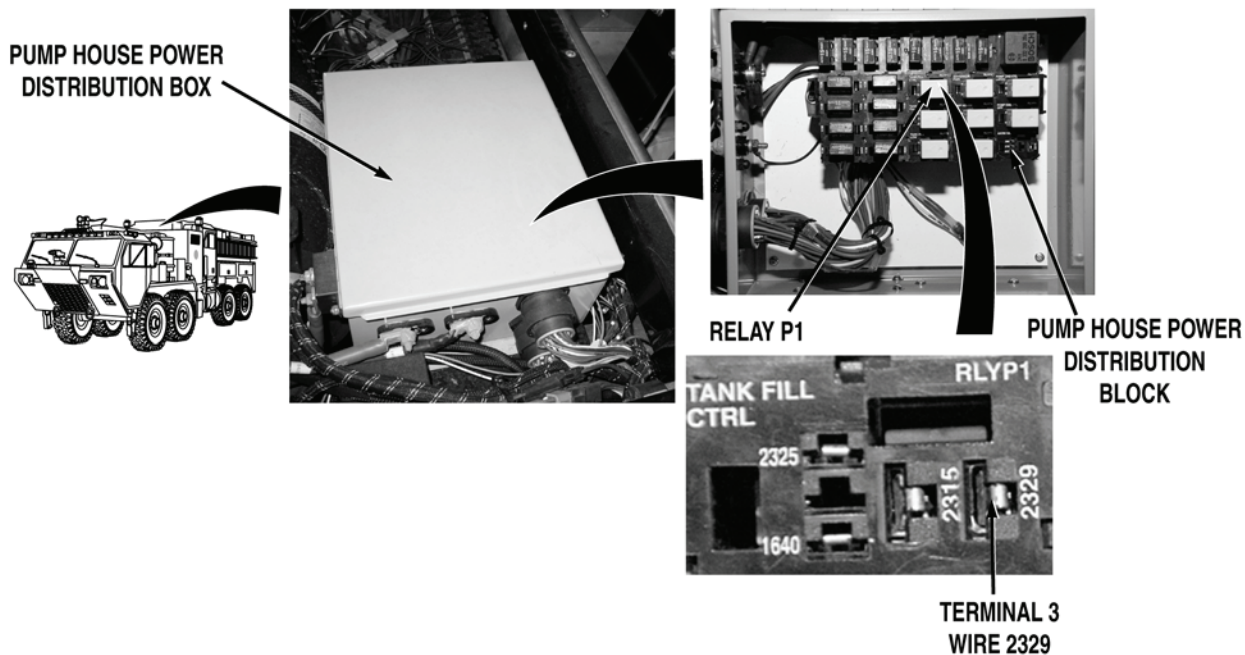

Step 14. Put pump operator's panel DIRECT TANK FILL switch to AUTO position (WP 0004). With a test lead set, check for 22 to 28 VDC between pump house power distribution wire harness wire 2329 (blue) at relay P1 connector, terminal 3 and a known good ground.

If 22 to 28 VDC are not present, go to Step 19.

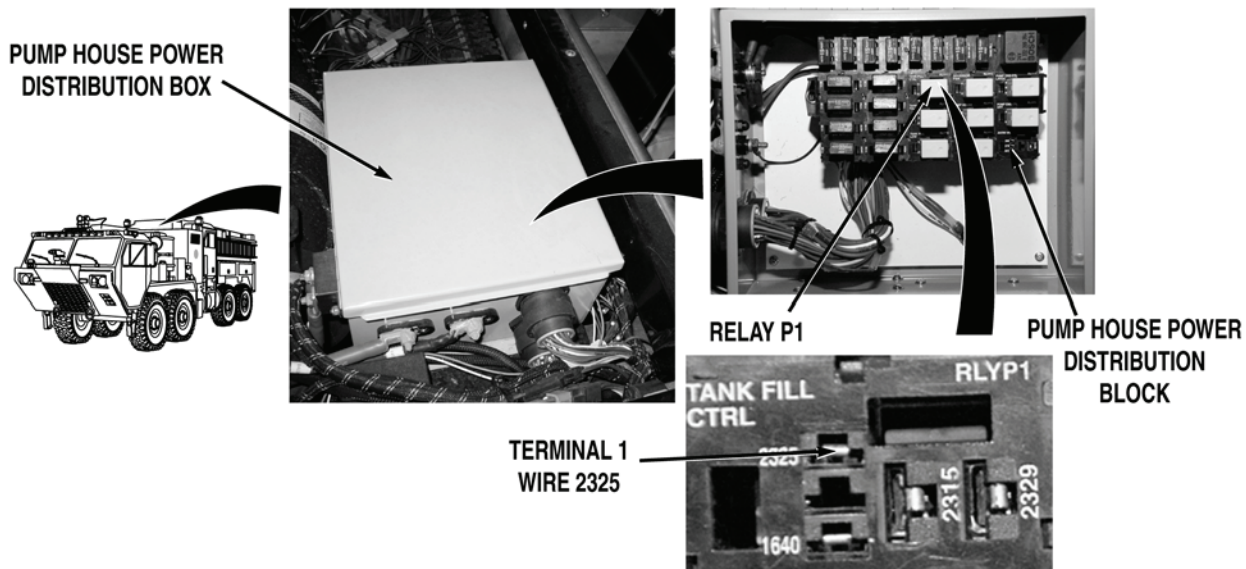
**MALFUNCTION****TEST OR INSPECTION****CORRECTIVE ACTION****WARNING**

Remove rings, wristwatches, neck chains, and any other jewelry before working around vehicle. Jewelry can catch on equipment and cause serious injury. Jewelry and tools may short across electrical circuits and cause damage to equipment, or severe burns or electrical shock to personnel.

**NOTE**

Steps (15) through (18) will isolate fault to a faulty relay. Perform Steps as written, replacing relays when instructed, to ensure faulty relay is located.

- Step 15. Turn battery disconnect switch to OFF position (WP 0007). Install relay P2 (WP 0413). Turn battery disconnect switch to ON position (WP 0007). With a test lead set, check for 22 to 28 VDC between pump house power distribution wire harness wire 2325 (black) at relay P1 connector, terminal 1 and a known good ground.

If 22 to 28 VDC are not present, install relay P1 and replace relay P2 (WP 0413).

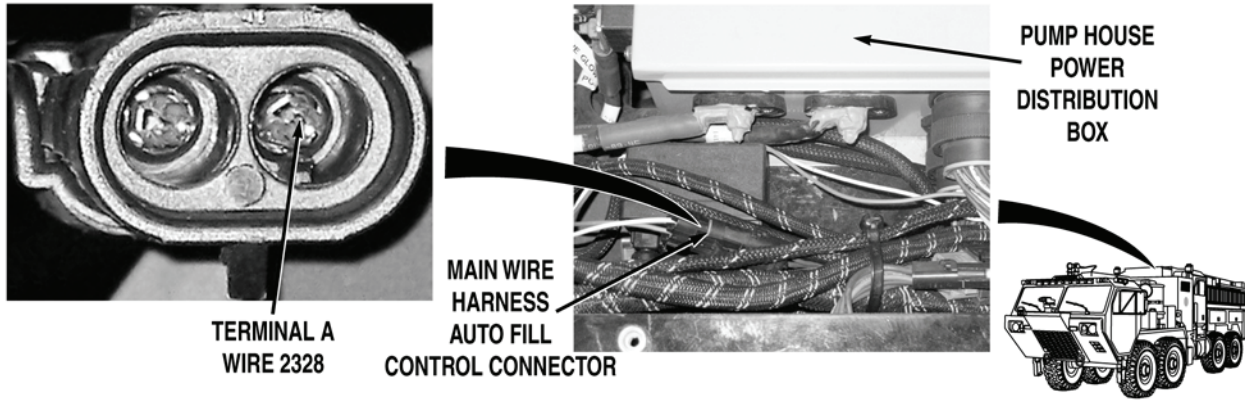
**MALFUNCTION****TEST OR INSPECTION****CORRECTIVE ACTION**

- Step 16. Install test lead set between main wire harness wire 2328 (green) at auto tank fill controller connector, terminal A and a known good ground. Check for 0 VDC between pump house power distribution wire harness wire 2325 at relay P1 connector, terminal 1 and a known good ground.

If 22 to 28 VDC are present, install relays in original positions and replace relay P2 (WP 0413).

## MALFUNCTION

## TEST OR INSPECTION

## CORRECTIVE ACTION

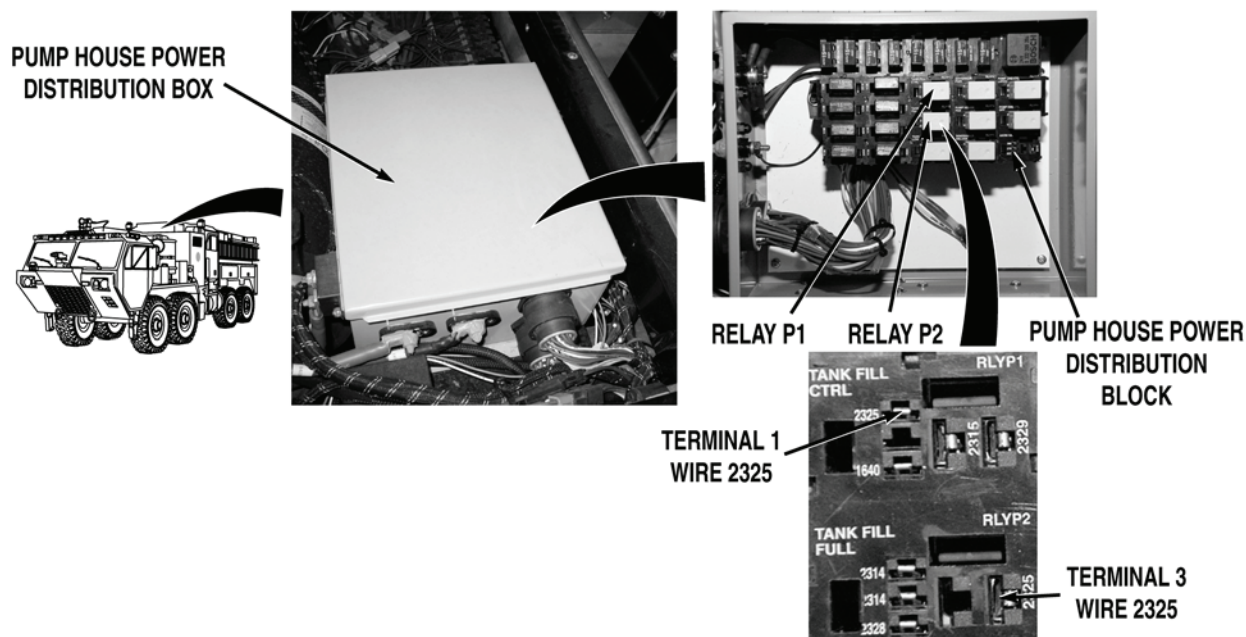

- Step 17. Turn battery disconnect switch to OFF Position (WP 0007). Remove relay P2 (WP 0413). Install relay P3 in relay P2 connector location (WP 0413). Turn battery disconnect switch to ON position (WP 0007). With a test lead set installed between main wire harness wire 2328 (green) at auto fill controller connector, terminal A and a known good ground. Check for 0 VDC between pump house power distribution wire harness wire 2325 (black) at relay P1 connector, terminal 1 and a known good ground.

If 22 to 28 VDC are present, install relays in original positions and replace relay P3 (WP 0413).

- Step 18. Turn battery disconnect switch to OFF position (WP 0007). Remove relay P3 from relay P2 connector (WP 0413). Install relay P1 in relay P2 connector location (WP 0413). Turn battery disconnect switch to ON position (WP 0007). With a test lead set installed between main wire harness wire 2328 (green) at auto tank fill controller connector, terminal A and a known good ground. Check for 0 VDC between pump house power distribution wire harness wire 2325 (black) at relay P1 connector, terminal 1 and a known good ground
- a. If 22 to 28 VDC are present, install relays in original positions and replace relay P1 (WP 0413).
  - b. If direct tank fill auto tank fill function does not operate properly, replace auto tank fill controller (WP 0418).

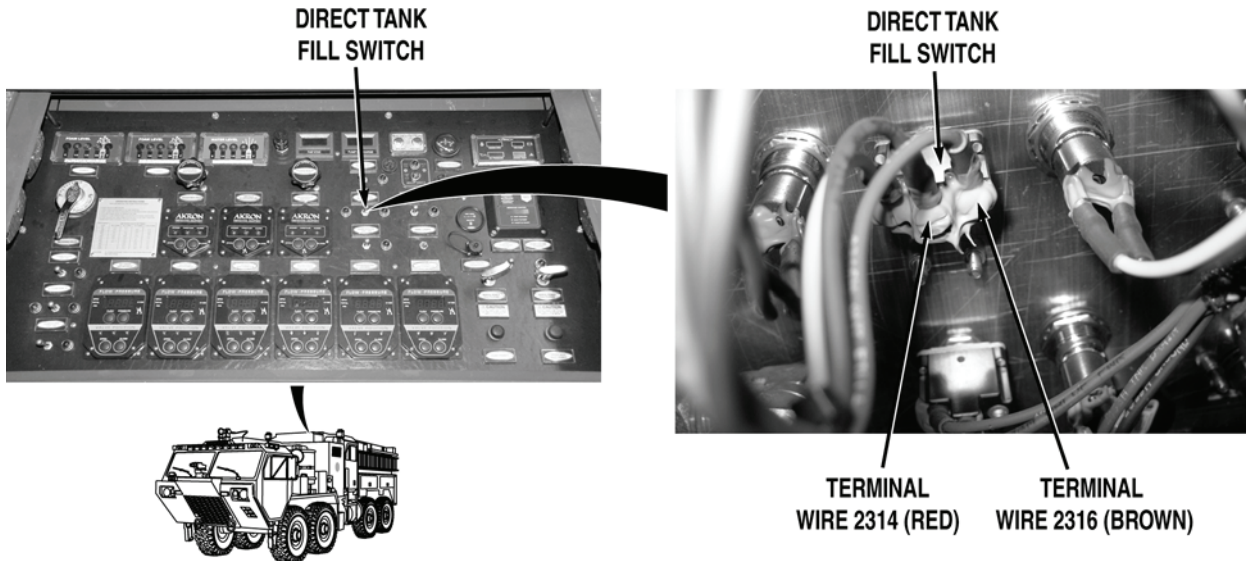
**MALFUNCTION****TEST OR INSPECTION****CORRECTIVE ACTION****WARNING**

**Remove rings, wristwatches, neck chains, and any other jewelry before working around vehicle. Jewelry can catch on equipment and cause serious injury. Jewelry and tools may short across electrical circuits and cause damage to equipment, or severe burns or electrical shock to personnel.**

- Step 19. Turn battery disconnect switch to OFF position (WP 0007). Open pump operator's panel housing (WP 0325). Connect main wire harness auto tank fill controller connector. Check for continuity across pump operator's panel DIRECT TANK FILL switch, from terminal wire 2314 (red) to terminal wire 2316 (brown), when switch is in AUTO position.

If there is no continuity, replace DIRECT TANK FILL switch (WP 0337).



---

<b>MALFUNCTION</b>	<b>TEST OR INSPECTION</b>	<b>CORRECTIVE ACTION</b>
--------------------	---------------------------	--------------------------

---

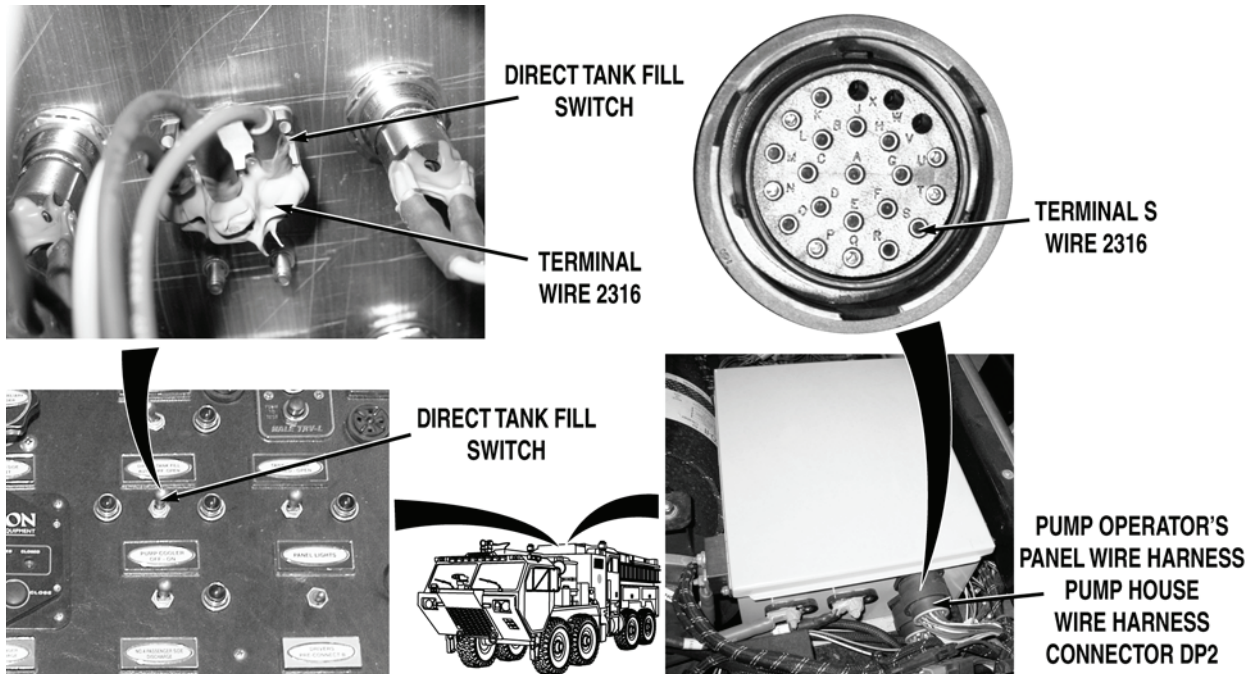

- Step 20. Disconnect pump operator's panel wire harness pump house power distribution wire harness connector DP2. With a test lead set, check for continuity across wire 2316 (brown) from pump operator's panel DIRECT TANK FILL switch, terminal wire 2316 to pump operator's panel wire harness pump house power distribution wire harness connector DP2, terminal S.
- a. If there is continuity, repair wire 2316 in pump house power distribution wire harness if repairable (TM 9-2320-325-14&P), or replace pump house power distribution wire harness and block (WP 0457).
  - b. If there is continuity, repair wire 2316 in pump operator's panel wire harness if repairable (TM 9-2320-325-14&P), or replace pump operator's panel wire harness (WP 0459).

## MALFUNCTION

## TEST OR INSPECTION

## CORRECTIVE ACTION

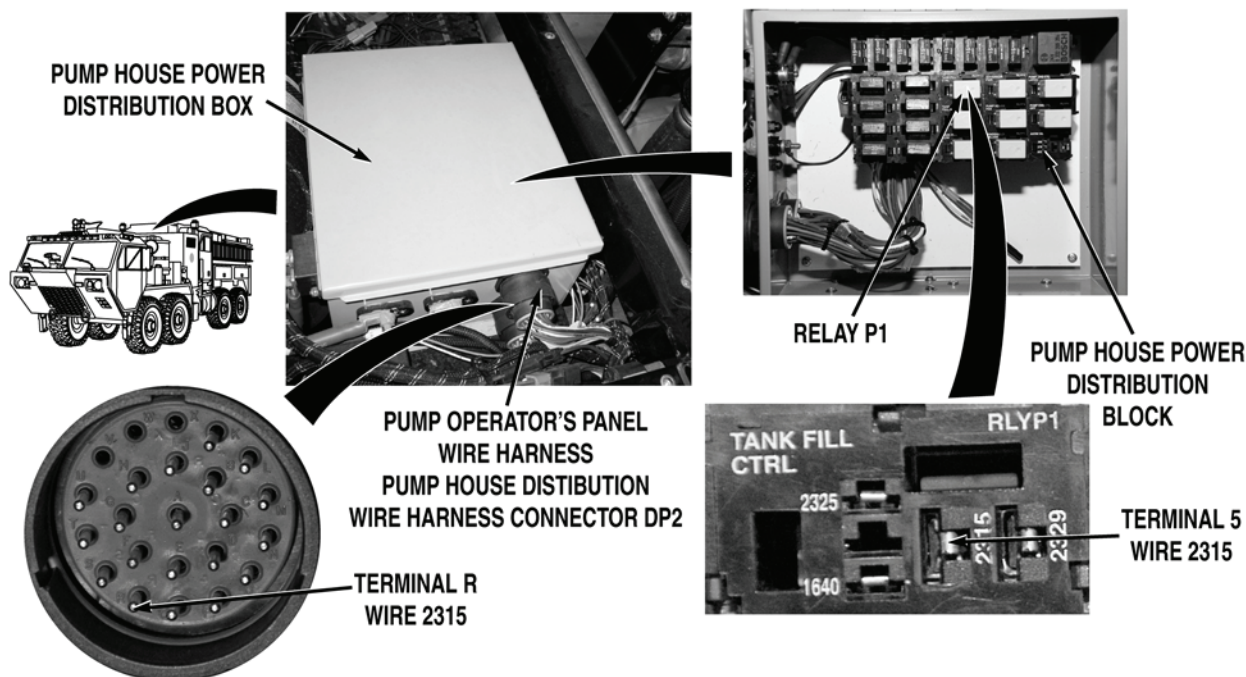
**WARNING**

Remove rings, wristwatches, neck chains, and any other jewelry before working around vehicle. Jewelry can catch on equipment and cause serious injury. Jewelry and tools may short across electrical circuits and cause damage to equipment, or severe burns or electrical shock to personnel.

- Step 21. Connect main wire harness auto tank fill controller connector. Disconnect pump operator's panel wire harness pump house power distribution wire harness connector DP2. With a test lead set, check for continuity across pump house power distribution wire harness wire 2315 (yellow) from relay P1 connector, terminal 5 to pump house power distribution wire harness connector DP2, terminal R.
- a. If there is no continuity, repair wire 2315 in pump house power distribution wire harness if repairable (TM 9-2320-325-14&P), or replace pump house power distribution wire harness and block (WP 0457).
  - b. If there is continuity, repair wire 2316 in pump operator's panel wire harness if repairable (TM 9-2320-325-14&P), or replace pump operator's panel wire harness (WP 0459).

## MALFUNCTION

## TEST OR INSPECTION

## CORRECTIVE ACTION

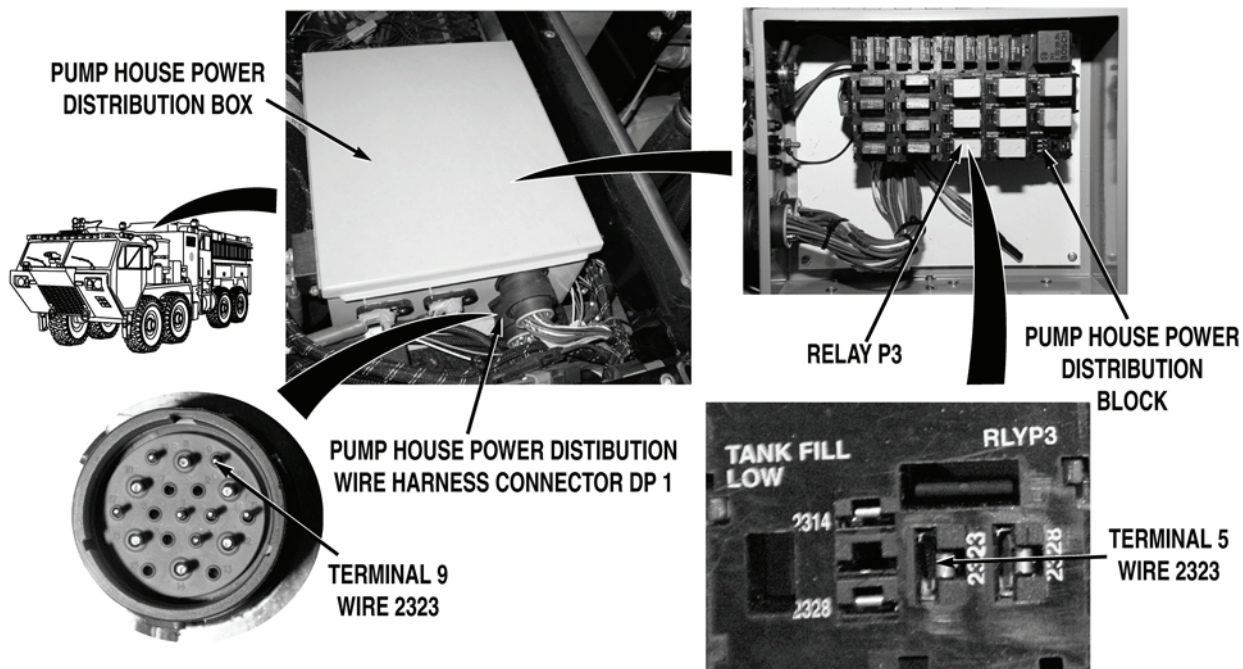
**WARNING**

Remove rings, wristwatches, neck chains, and any other jewelry before working around vehicle. Jewelry can catch on equipment and cause serious injury. Jewelry and tools may short across electrical circuits and cause damage to equipment, or severe burns or electrical shock to personnel.

- Step 22. Disconnect pump operator's panel wire harness pump house power distribution wire harness connector DP1. With a test lead set, check for continuity across pump house power distribution wire harness wire 2323 (brown) from relay P3 connector, terminal 5, to pump house power distribution wire harness connector DP1, terminal 9.
- a. If there is continuity, repair wire 2323 in pump operator's panel wire harness if repairable (TM 9-2320-325-14&P), or replace pump operator's wire harness (WP 0459).
  - b. If there is no continuity, repair wire 2323 in pump house power distribution wire harness if repairable (TM 9-2320-325-14&P), or replace pump house power distribution wire harness and block (WP 0457).

## MALFUNCTION

## TEST OR INSPECTION

## CORRECTIVE ACTION

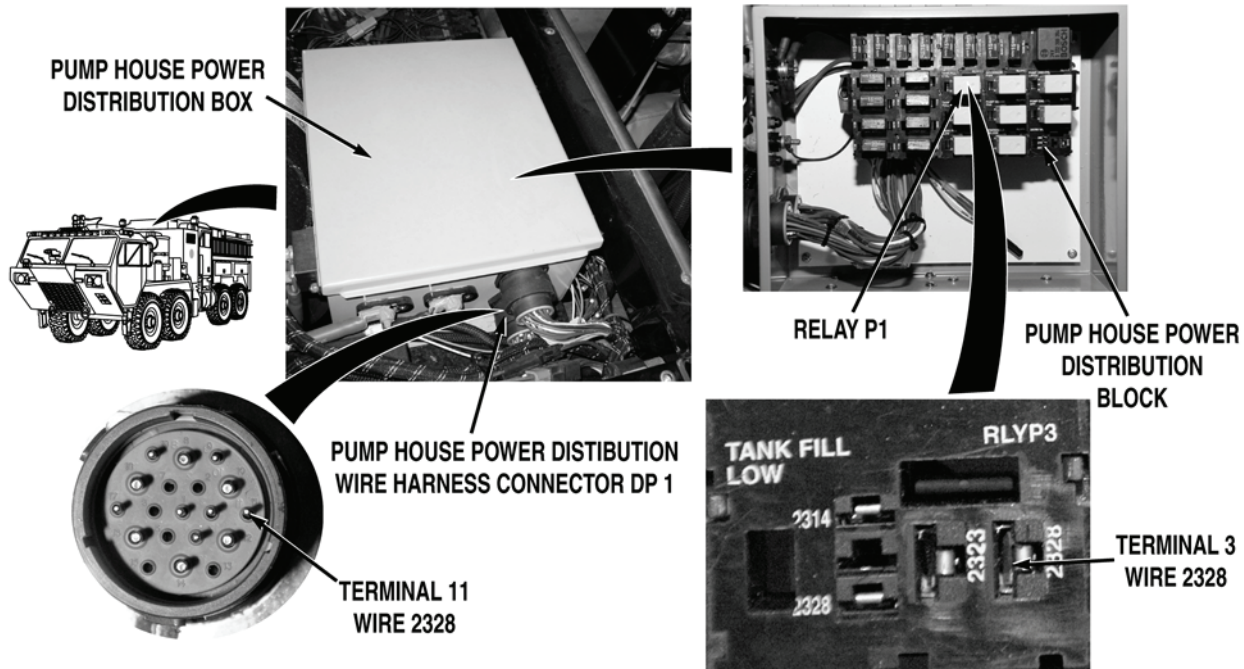
**WARNING**

Remove rings, wristwatches, neck chains, and any other jewelry before working around vehicle. Jewelry can catch on equipment and cause serious injury. Jewelry and tools may short across electrical circuits and cause damage to equipment, or severe burns or electrical shock to personnel.

- Step 23. Disconnect pump operator's panel wire harness pump house power distribution wire harness connector DP1. With a test lead set, check for continuity across pump house power distribution wire harness wire 2328 (green) from relay P3 connector, terminal 3 to pump house power distribution wire harness connector DP1, terminal 11.
- a. If there is continuity, repair wire 2328 in pump house wire harness if repairable (TM 9-2320-325-14&P), or replace pump house wire harness (WP 0459).
  - b. If there is no continuity, repair wire 2328 in pump house power distribution wire harness if repairable (TM 9-2320-325-14&P), or replace pump house power distribution wire harness and block (WP 0457).

**MALFUNCTION**  
**TEST OR INSPECTION**  
**CORRECTIVE ACTION**

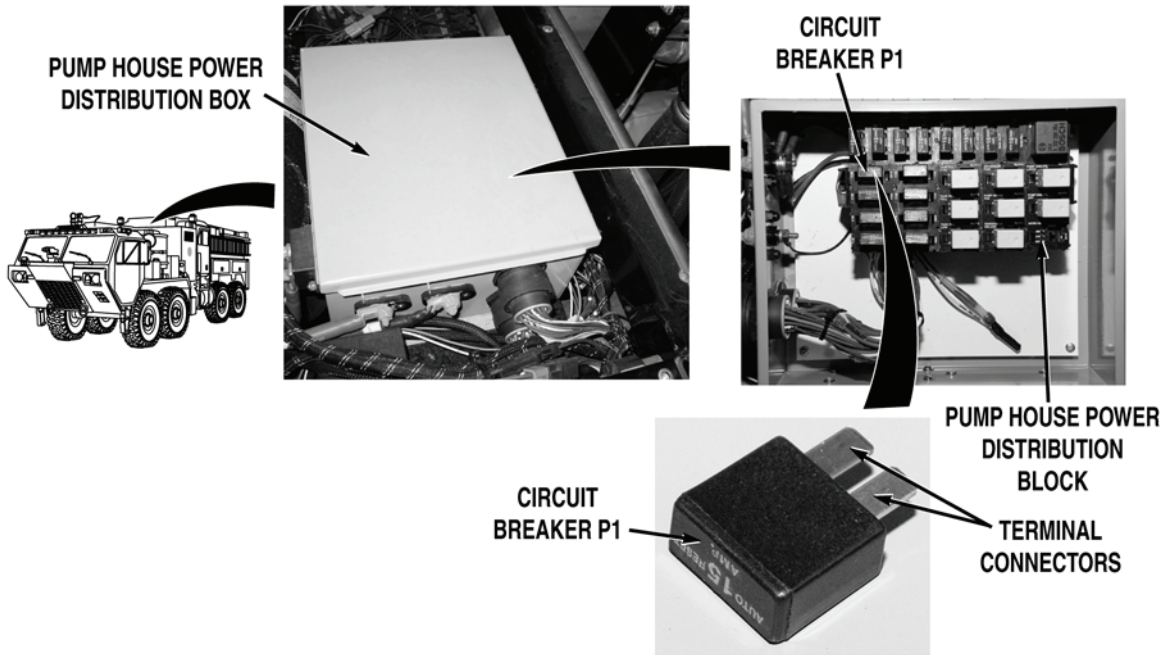

**WARNING**



Remove rings, wristwatches, neck chains, and any other jewelry before working around vehicle. Jewelry can catch on equipment and cause serious injury. Jewelry and tools may short across electrical circuits and cause damage to equipment, or severe burns or electrical shock to personnel.

- Step 24. Turn battery disconnect switch to OFF position (WP 0007). Remove pump house panel S (WP 0540). Open pump house power distribution box (WP 0412). Remove circuit breaker P1 (WP 0412). Check for continuity across circuit breaker.

If there is no continuity, replace circuit breaker P1 (WP 0412).

---

**MALFUNCTION****TEST OR INSPECTION****CORRECTIVE ACTION**

---



- Step 25. Install circuit breaker P1 (WP 0412). Open pump operator's housing (WP 0540). Disconnect pump operator's panel wire harness direct tank fill valve connector. Turn battery disconnect switch to ON position (WP 0007). With a test lead set, check for 22 to 28 VDC between pump operator's panel wire harness wire 2314 (red) at direct tank fill valve wire harness connector, terminal 1 and a known good ground.

If 22 to 28 VDC are not present, repair wire 2314 in pump house power distribution wire harness if repairable (TM 9-2320-325-14&P), or replace pump house distribution wire harness and block (WP 0457).

---

<b>MALFUNCTION</b>		
	<b>TEST OR INSPECTION</b>	
		<b>CORRECTIVE ACTION</b>

---

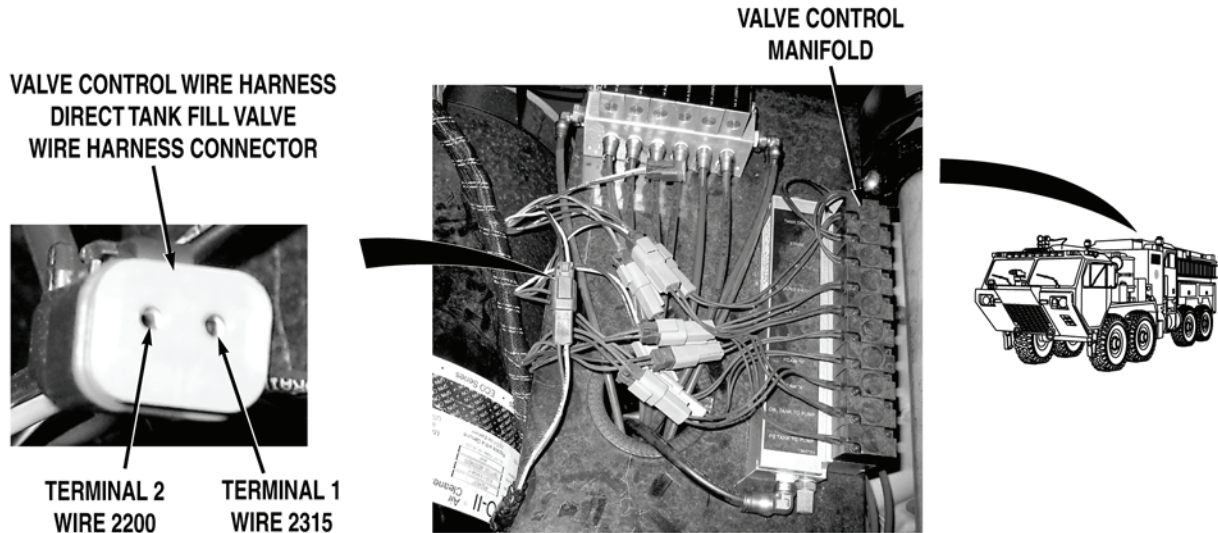
**WARNING**

**Remove rings, wristwatches, neck chains, and any other jewelry before working around vehicle. Jewelry can catch on equipment and cause serious injury. Jewelry and tools may short across electrical circuits and cause damage to equipment, or severe burns or electrical shock to personnel.**

- Step 26. Turn battery disconnect switch to OFF position (WP 0007). Disconnect valve control wire harness direct tank fill valve connector. Put pump operator's panel DIRECT TANK FILL switch to OPEN position (WP 0004). Turn battery disconnect switch to ON position (WP 0007). With a test lead set, check for 22 to 28 VDC between valve control wire harness wire 2315 (yellow) at valve control wire harness direct tank fill wire harness connector, terminal 1 and a known good ground.

If 22 to 28 VDC are not present, go to Step 31.

- Step 27. Put DIRECT TANK FILL switch to OFF position (WP 0004). Turn battery disconnect switch to OFF position (WP 0007). With a test lead set, check for continuity across wire 2200 (black) from valve control wire harness direct tank fill valve connector, terminal 2 to a known good ground.

If there is no continuity, repair wire 2200 in valve control wire harness if repairable (TM 9-2320-325-14&P), or replace valve control wire harness (WP 0463).

**MALFUNCTION**

**TEST OR INSPECTION**

**CORRECTIVE ACTION**

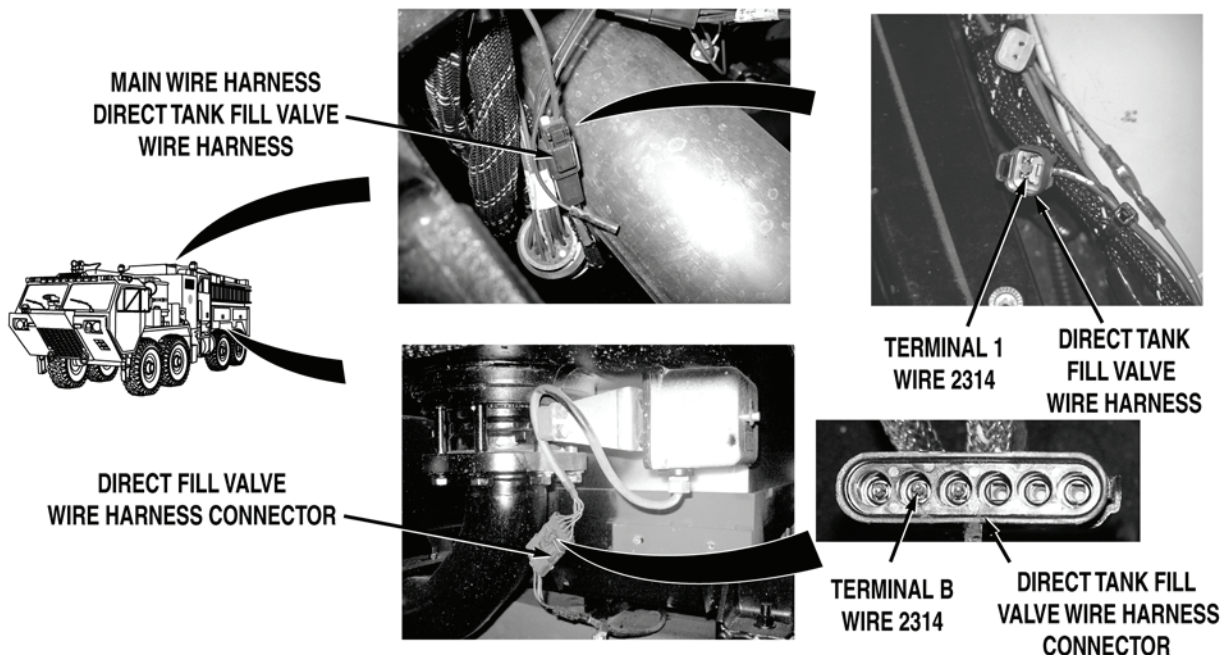

Step 28. Disconnect direct tank fill valve wire harness direct tank fill valve connector. With a test lead set, check for continuity across direct tank fill valve wire harness wire 2314 (red) from main wire harness direct tank fill wire harness connector, terminal 1 to direct tank fill valve wire harness connector, terminal B.

If there is no continuity, repair wire 2314 in direct tank fill valve wire harness if repairable (TM 9-2320-325-14&P), or replace direct tank fill valve wire harness (WP 0447).

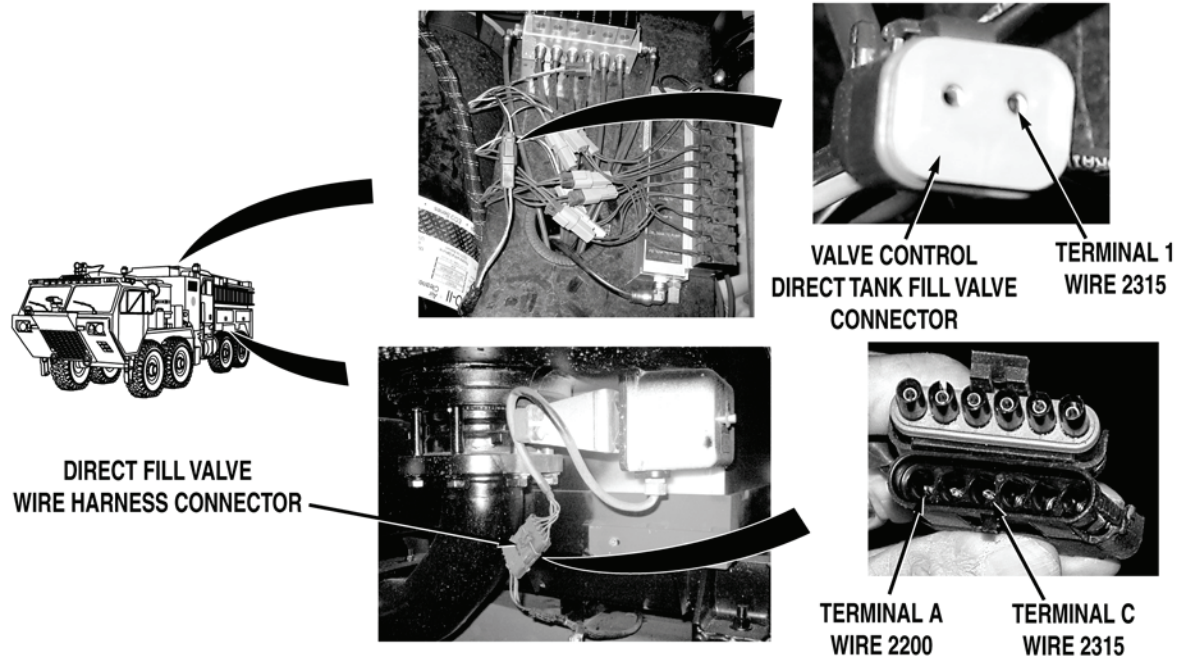

**MALFUNCTION****TEST OR INSPECTION****CORRECTIVE ACTION**

- Step 29. With a test lead set, check for continuity across direct tank fill valve wire harness wire 2315 (yellow) from valve control wire harness direct tank fill valve connector, terminal 1 to direct tank fill valve wire harness connector, terminal C.

If there is no continuity, repair wire 2315 in direct tank fill valve wire harness if repairable (TM 9-2320-325-14&P), or replace direct tank fill valve wire harness (WP 0447).

- Step 30. With a test lead set, check for continuity across direct tank fill valve wire harness wire 2200 (black) from direct tank fill valve wire harness connector, terminal A to a known good ground.
- a. If there is continuity, replace direct tank fill valve actuator (WP 0303).
  - b. If there is no continuity, repair wire 2200 in direct tank fill valve wire harness if repairable (TM 9-2320-325-14&P), or replace direct tank fill valve wire harness (WP 0447).

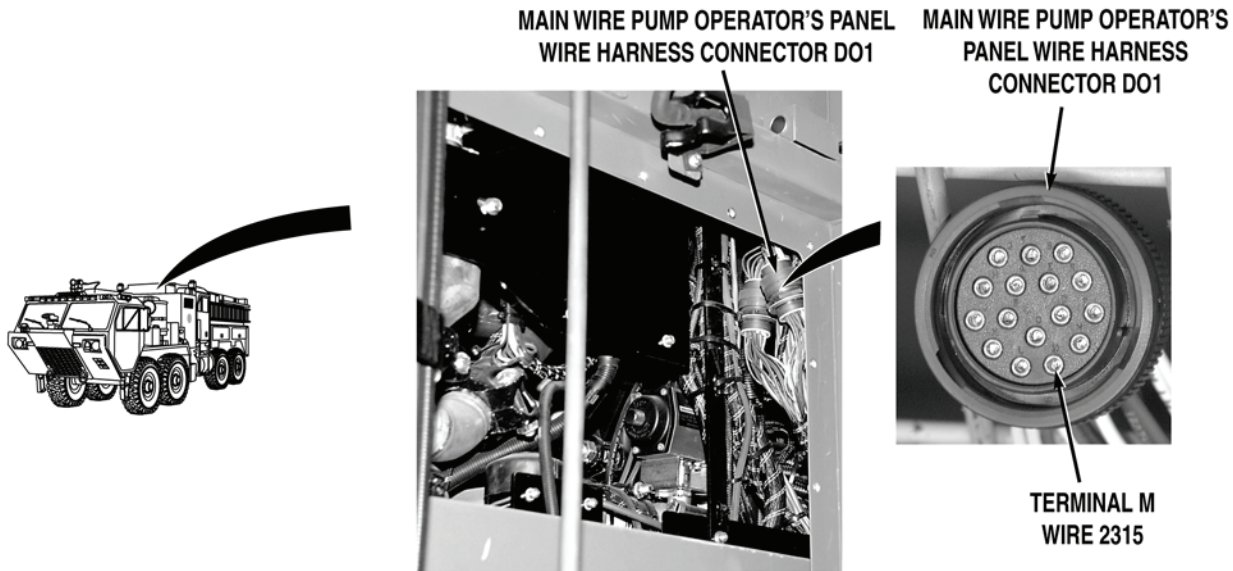
**MALFUNCTION****TEST OR INSPECTION****CORRECTIVE ACTION****WARNING**

**Remove rings, wristwatches, neck chains, and any other jewelry before working around vehicle. Jewelry can catch on equipment and cause serious injury. Jewelry and tools may short across electrical circuits and cause damage to equipment, or severe burns or electrical shock to personnel.**

- Step 31. Remove driver side crew cab panel (WP 0499). Remove pump house panel Q (WP 0540). Turn battery disconnect switch to OFF position (WP 0007). Disconnect main wire harness pump operator's panel wire harness connector DO1. Turn battery disconnect switch to ON position (WP 0007). With a test lead set, check for 22 to 28 VDC between main wire harness wire 2315 (yellow) at main wire harness pump operator's panel wire harness connector, terminal M to a known good ground.

If 22 to 28 VDC are present, repair wire 2315 in valve control wire harness if repairable (TM 9-2320-325-14&P), or replace valve control wire harness (WP 0463).

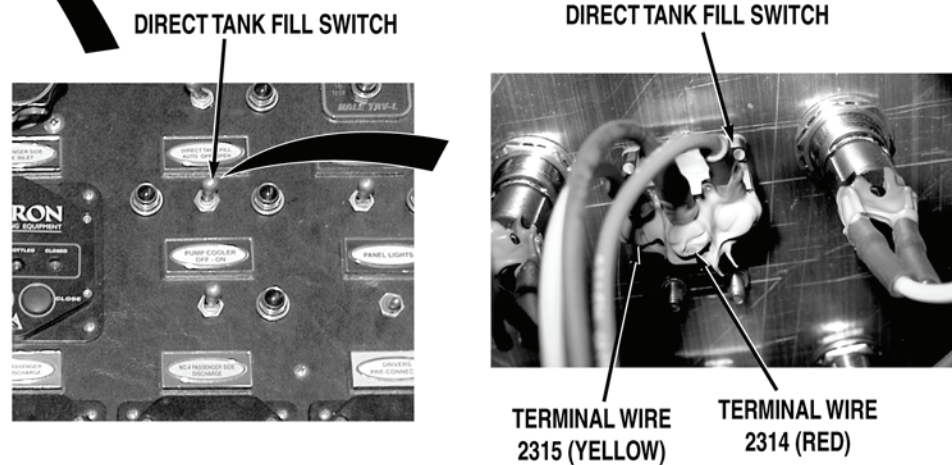
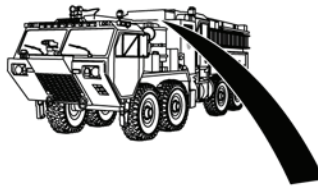
**MALFUNCTION****TEST OR INSPECTION****CORRECTIVE ACTION**

Step 32. Open pump operator's panel housing (WP 0325). Check for 22 to 28 VDC between pump operator's panel wire harness wire 2314 (red) at DIRECT TANK FILL switch terminal and a known good ground.

If 22 to 28 VDC are not present, go to Step 34.

Step 33. Turn battery disconnect switch to OFF position (WP 0007). Check for continuity across pump operator's panel DIRECT TANK FILL switch from terminal wire 2314 (red) to terminal wire 2315 (yellow), when switch is in OPEN position.

If there is no continuity, replace DIRECT TANK FILL switch (WP 0337).

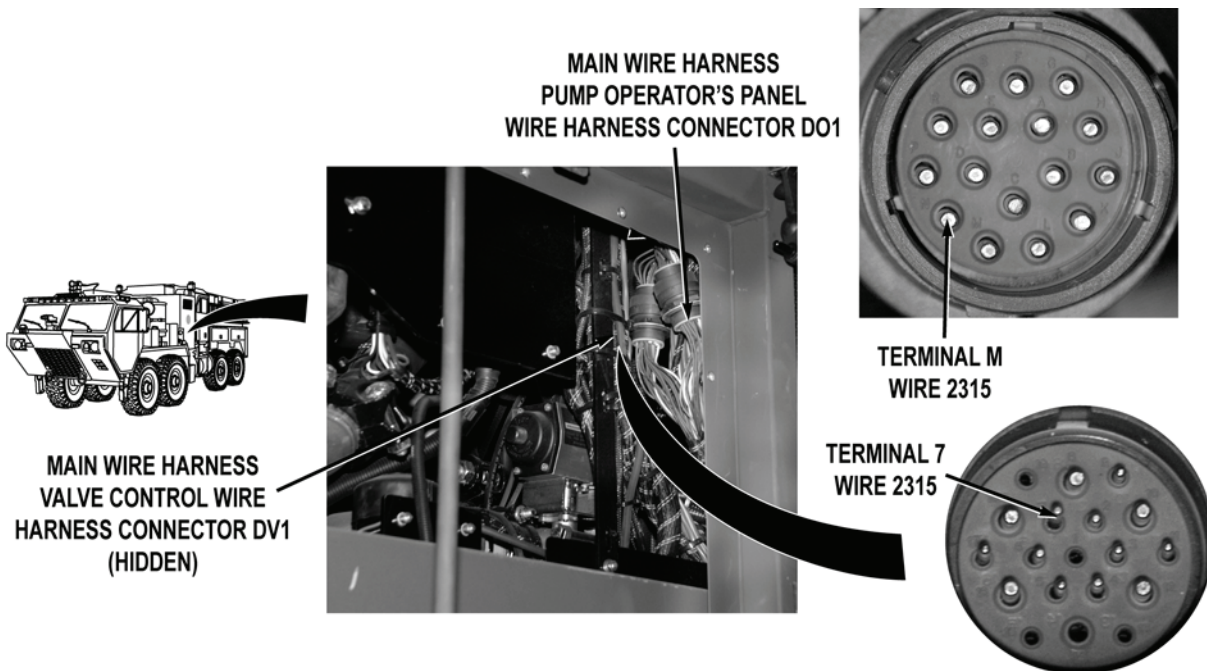
**MALFUNCTION****TEST OR INSPECTION****CORRECTIVE ACTION**

- Step 34. Turn battery disconnect switch to OFF position (WP 0007). Disconnect main wire harness valve control wire harness connector DV1. Turn battery disconnect switch to ON position (WP 0007). With a test lead set, check for continuity across main wire harness wire 2315 (yellow) from main wire harness valve control wire harness connector DV1, terminal 7 to main wire harness pump operator's panel wire harness connector DO1, terminal M.
- a. If there is continuity, repair wire 2315 in pump operator's panel wire harness if repairable (TM 9-2320-325-14&P), or replace pump operator's panel wire harness (WP 0459).
  - b. If there is no continuity at either terminal, repair wire 2315 in main wire harness if repairable (TM 9-2320-325-14&P), or replace main wire harness (WP 0455).

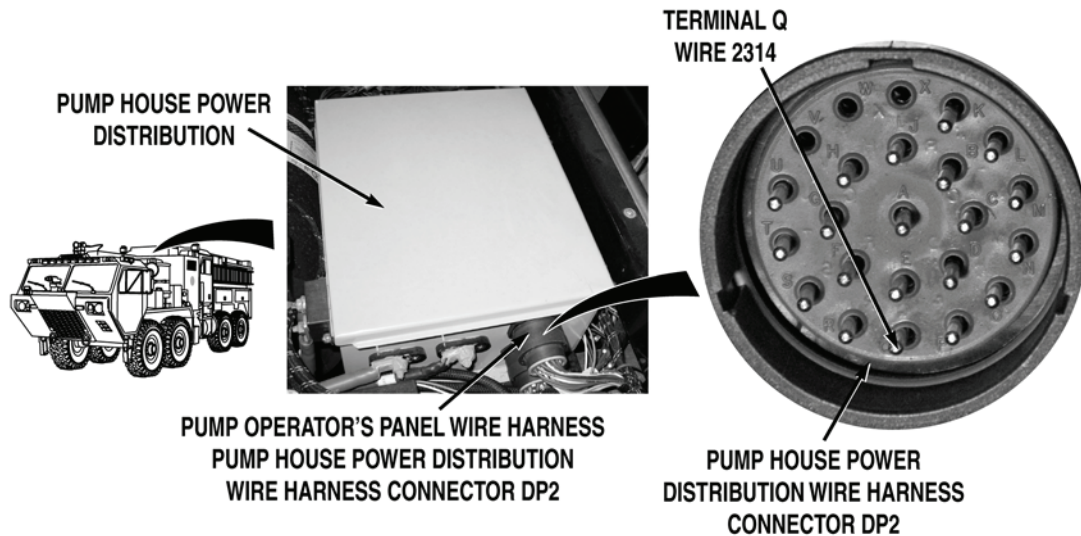
**MALFUNCTION****TEST OR INSPECTION****CORRECTIVE ACTION****WARNING**

**Remove rings, wristwatches, neck chains, and any other jewelry before working around vehicle. Jewelry can catch on equipment and cause serious injury. Jewelry and tools may short across electrical circuits and cause damage to equipment, or severe burns or electrical shock to personnel.**

- Step 35. Turn battery disconnect switch to OFF position (WP 0007). Disconnect pump operator's panel wire harness pump house power distribution wire harness connector DP2. Turn battery disconnect switch to ON position (WP 0007). With a test lead set, check for 22 to 28 VDC between pump house power distribution wire harness wire 2314 (red) at connector DP2, terminal Q and a known good ground.
- a. If 22 to 28 VDC are not present, repair wire 2314 in pump house power distribution wire harness if repairable (TM 9-2320-325-14&P), or replace pump house power distribution wire harness and block (WP 0457).
  - b. If there is continuity, repair wire 2314 in pump operator's panel wire harness if repairable (TM 9-2320-325-14&P), or replace pump operator's panel wire harness (WP 0459).

**END OF TASK**

**FOLLOW-ON MAINTENANCE**

Remove wheel chocks (TM 9-2320-347-10)

**END OF TASK**

**END OF WORK PACKAGE**

**FIELD LEVEL MAINTENANCE**

**DRIVER MAIN INLET VALVE DOES NOT OPERATE PROPERLY**

**Tools and Special Tools**

Lead Set, Test (WP 0622, Item 21)  
 Tool Kit, General Mechanic's: Automotive  
 (WP 0622, Item 27)

**References**

TM 9-2320-325-14&P  
 WP 0004  
 WP 0007  
 WP 0484  
 WP 0325  
 WP 0387  
 WP 0388

**References (continued)**

WP 0412  
 WP 0418  
 WP 0453  
 WP 0457  
 WP 0459  
 WP 0539  
 WP 0540

**Equipment Conditions**

Water pump engine OFF (WP 0022)  
 Engine OFF (TM 9-2320-347-10)  
 Wheels chocked (TM 9-2320-347-10)

**MALFUNCTION**

**TEST OR INSPECTION**

**CORRECTIVE ACTION**

**DRIVER MAIN INLET VALVE DOES NOT OPERATE PROPERLY**

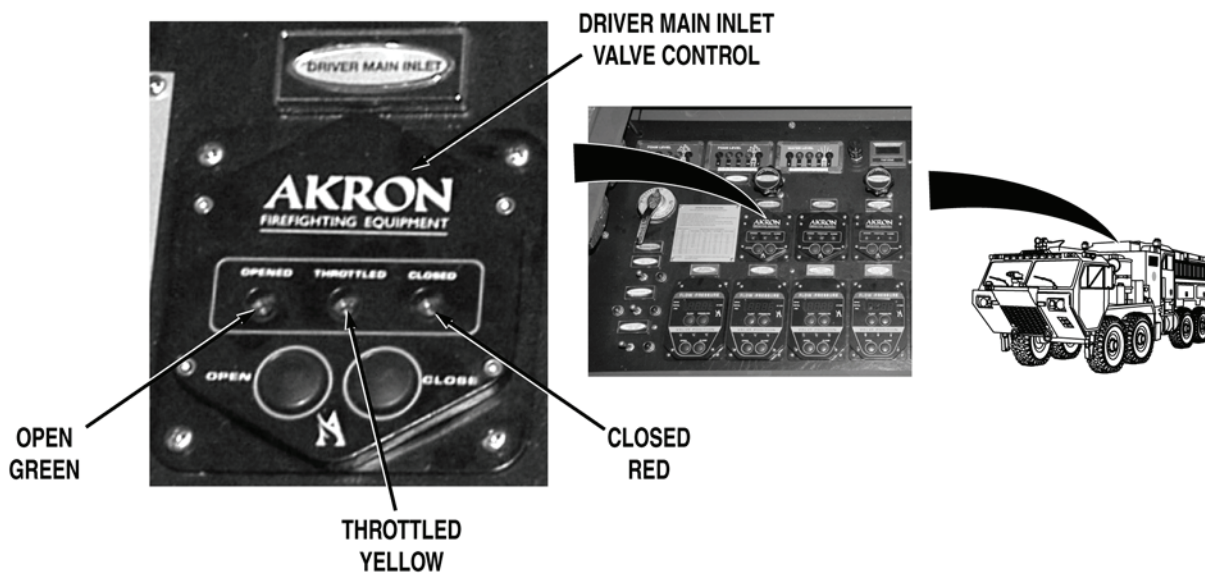

**NOTE**

Ensure batteries are fully charged before performing Step 1.

Step 1. Turn battery disconnect switch to ON position (WP 0007). Check if pump operator's panel DRIVER MAIN INLET valve control display illuminates (WP 0004).

If display is not illuminated, go to Step 12.

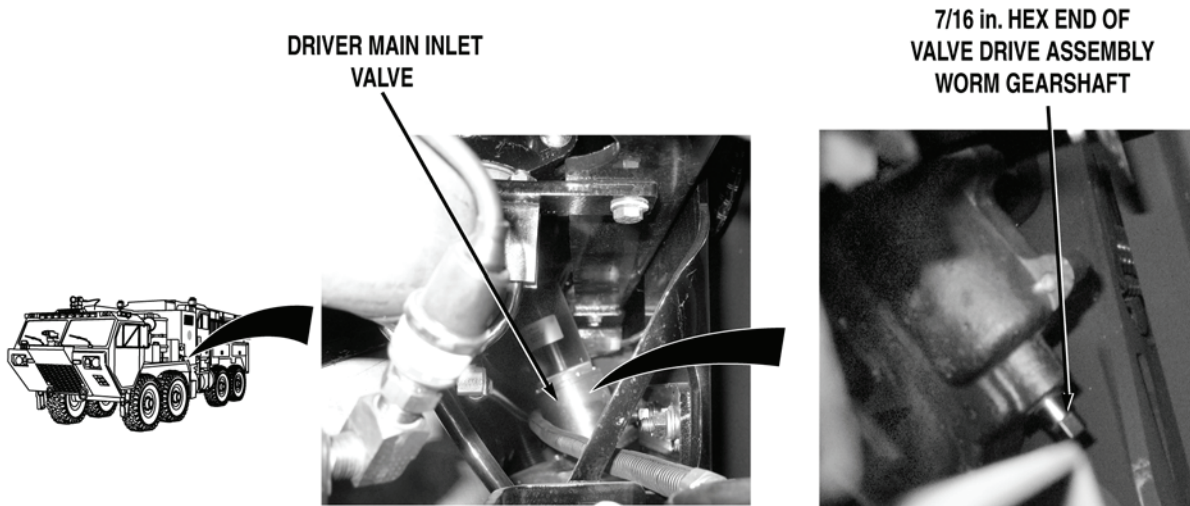
**MALFUNCTION****TEST OR INSPECTION****CORRECTIVE ACTION****NOTE**

- Valve operation can be checked either by noting vibration of valve assembly, or by observing rotation of 7/16 in. hex at end of valve drive assembly worm gearshaft.
- Do not remove cap from DRIVER MAIN INLET. Water may be released from system when valve is operated.

Step 2. Open driver side pump operator's panel door A (WP 0325). While an assistant pushes pump operator's panel DRIVER MAIN INLET valve control OPEN and CLOSE buttons (WP 0004), check if driver main inlet valve operates.

If driver main inlet valve does not open and close, go to Step 8.

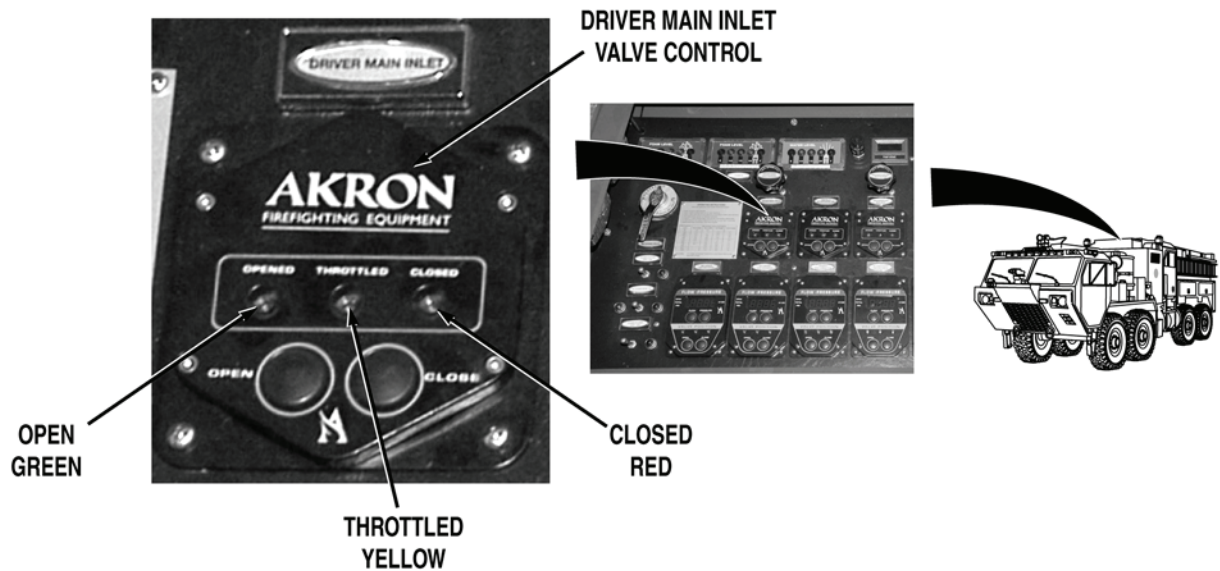

**MALFUNCTION****TEST OR INSPECTION****CORRECTIVE ACTION****NOTE**

DRIVER MAIN INLET valve control will indicate yellow 'THROTTLED' indicator when valve is partially opened or closed.

- Step 3. While an assistant monitors operation of driver main inlet valve, push pump operator's panel DRIVER MAIN INLET valve control OPEN and CLOSE buttons (WP 0004). Check if DRIVER MAIN INLET valve control OPENED (green) and CLOSED (red) indicators illuminate before valve is fully opened or closed.

If DRIVER MAIN INLET valve control indicators illuminate before driver main inlet valve is fully opened or closed, go to Step 6.

## MALFUNCTION

## TEST OR INSPECTION

## CORRECTIVE ACTION

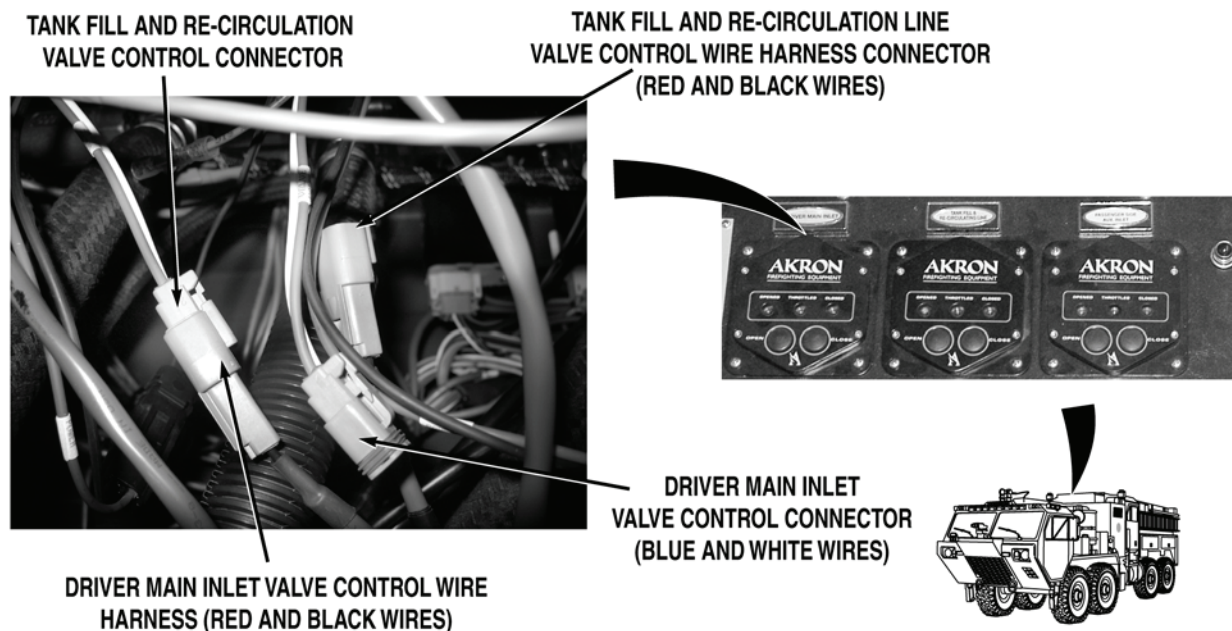
**WARNING**

Remove rings, wristwatches, neck chains, and any other jewelry before working around vehicle. Jewelry can catch on equipment and cause serious injury. Jewelry and tools may short across electrical circuits and cause damage to equipment, or severe burns or electrical shock to personnel.

- Step 4. Turn battery disconnect switch to OFF position (WP 0007). Open pump operator's panel (WP 0325). Disconnect valve control wire harness connector from DRIVER MAIN INLET valve control. Disconnect valve control wire harness connector from TANK FILL & RE-CIRCULATING LINE valve control. Connect driver main inlet valve control wire harness connector to TANK FILL & RE-CIRCULATING valve control. Turn battery disconnect switch to ON position (WP 0007). While an assistant monitors operation of driver main inlet valve, push pump operator's panel TANK FILL & RE-CIRCULATING valve control OPEN and CLOSE buttons (WP 0004). Check if TANK FILL & RE-CIRCULATING valve control OPENED (green) and CLOSED (red) indicators illuminate before driver main inlet valve is fully opened or closed.

If TANK FILL & RE-CIRCULATING valve control indicators do not illuminate before driver main inlet valve is fully opened or closed, reconnect valve control wire harnesses to original positions and replace DRIVER MAIN INLET valve control (WP 0418).

**MALFUNCTION****TEST OR INSPECTION****CORRECTIVE ACTION**

- Step 5. Turn battery disconnect switch to OFF position (WP 0007). Open pump house panel A (WP 0539). Remove driver main inlet valve (WP 0484) and inspect it for binding, damage, and contamination.
- If driver main inlet valve is free from binding, damage, and contamination, reinstall valve (WP 0484) and replace driver main inlet valve motor and drive assembly (WP 0388).
  - If driver main inlet valve is not free from binding, damage, or contamination, repair (WP 0387) or replace driver main inlet valve (WP 0484).

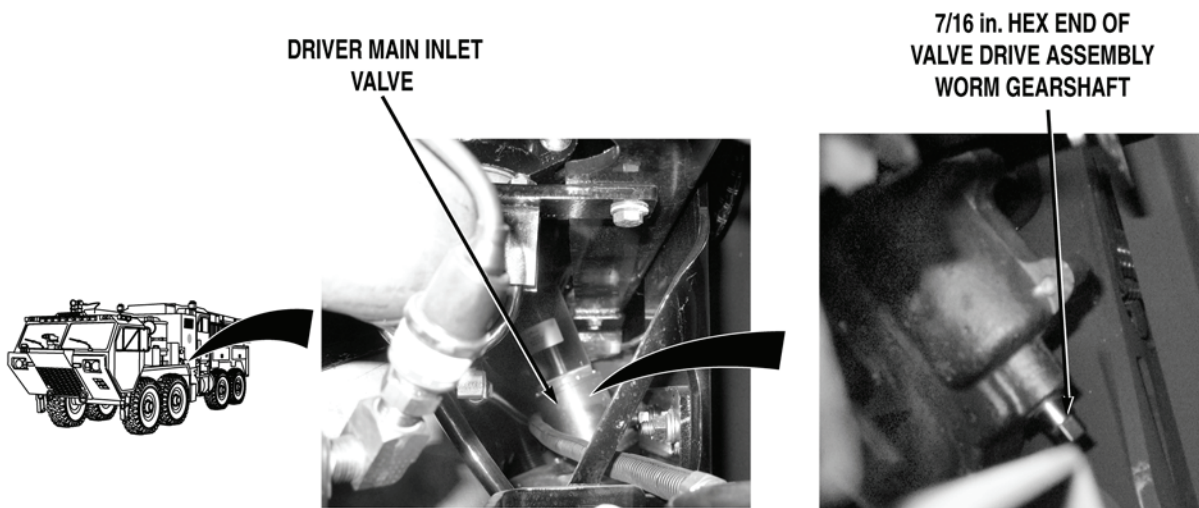
**NOTE**

Valve operations must be checked by observing rotation of 7/16 in. hex at end of valve drive assembly worm gearshaft for Step 6.

- Step 6. While an assistant pushes pump operator's panel DRIVER MAIN INLET valve control OPEN and CLOSE buttons (WP 0004), check if driver main inlet valve worm gearshaft moves after valve is fully opened or closed.
- If driver main inlet valve worm gearshaft moves excessively after valve is fully opened or closed, remove and reinstall driver main inlet valve motor (WP 0388), ensuring all mounting hardware is secure.
- Step 7. Remove pump house panel B (WP 0540). Remove driver main inlet valve (WP 0484) and inspect it for damage and contamination.
- If driver main inlet valve is free from damage and contamination, reinstall valve (WP 0484) and go to Step 8.
  - If driver main inlet valve is damaged and/or contaminated, repair (WP 0387) or replace driver main inlet valve (WP 0484).

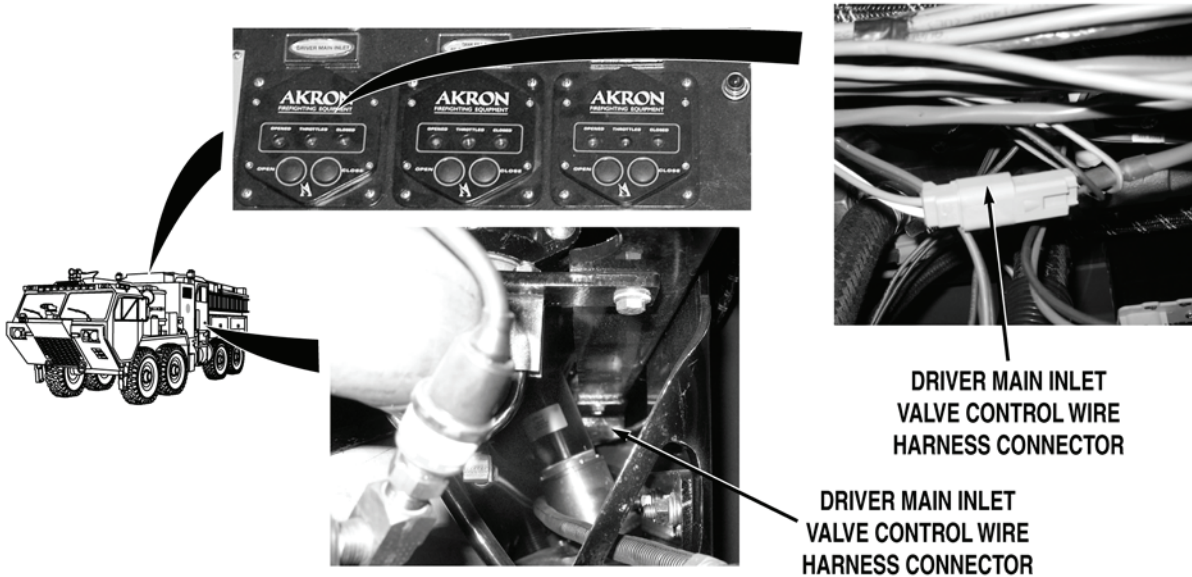
**MALFUNCTION****TEST OR INSPECTION****CORRECTIVE ACTION****WARNING**

**Remove rings, wristwatches, neck chains, and any other jewelry before working around vehicle. Jewelry can catch on equipment and cause serious injury. Jewelry and tools may short across electrical circuits and cause damage to equipment, or severe burns or electrical shock to personnel.**

- Step 8. Turn battery disconnect switch to OFF position (WP 0007). Open pump house panel A (WP 0539). Open pump operator's panel housing (WP 0325). Check driver main inlet valve control wire harness from DRIVER MAIN INLET valve control to driver main inlet valve motor for loose connections.

If connections are loose, reconnect driver main inlet valve control wire harness connectors (WP 0453).

---

**MALFUNCTION****TEST OR INSPECTION****CORRECTIVE ACTION**

---

**NOTE**

- Do not engage water pump engine during procedure. Valve operations can be checked without water pump operations.
- Valve motor operation can be checked either by noting vibration of valve assembly, or by observing rotation of 7/16 in. hex at end of valve drive assembly worm gearshaft.
- Do not remove cap from DRIVER MAIN INLET. Water may be released from system when valve is operated.

Step 9. Turn battery disconnect switch to ON position (WP 0007). While an assistant pushes pump operator's panel DRIVER MAIN INLET valve control OPEN and CLOSE buttons (WP 0004), check if DRIVER MAIN INLET valve control THROTTLED (yellow) indicator illuminates and driver main inlet valve motor operates.

If indicator illuminates and valve motor operates, replace driver main inlet valve drive assembly (WP 0388).

**MALFUNCTION**

**TEST OR INSPECTION**

**CORRECTIVE ACTION**



Step 10. Turn battery disconnect switch to OFF position (WP 0007). Disconnect valve control wire harness connector from DRIVER MAIN INLET valve control. Disconnect valve control wire harness connector from driver main inlet valve motor. With a test lead set, check for continuity across valve control wire harness from DRIVER MAIN INLET valve control connector to driver main inlet valve motor connector.

If there is no continuity, repair valve control wire harness if repairable (TM 9-2320-325-14&P), or replace driver main inlet valve control wire harness (WP 0453).

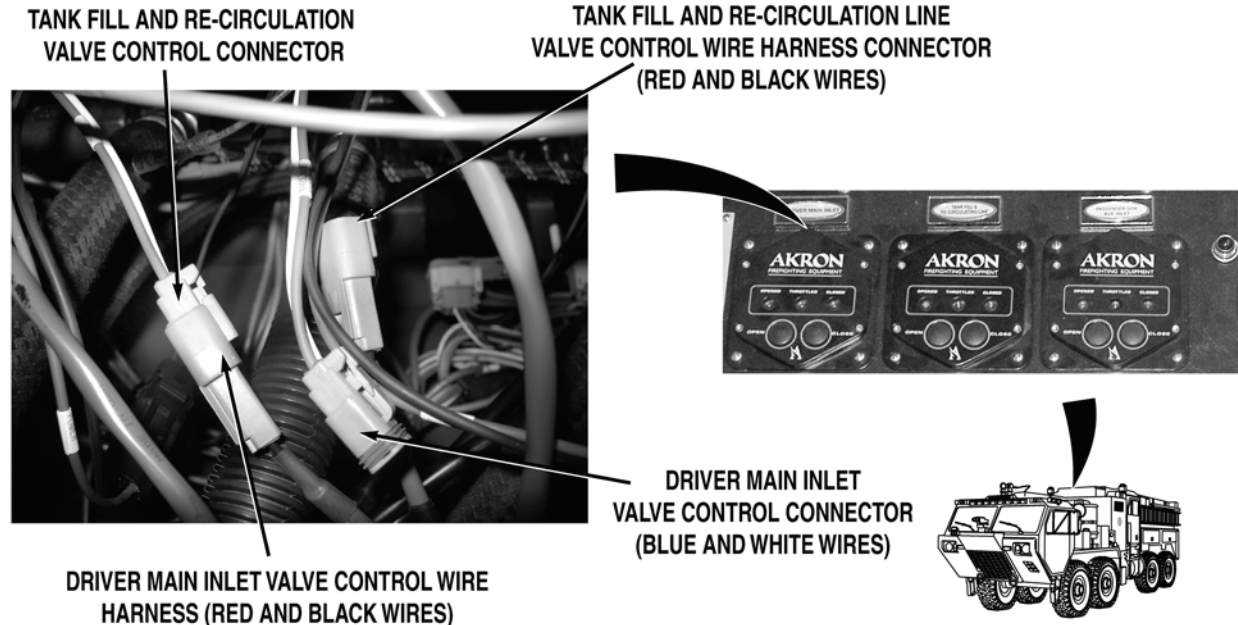
**MALFUNCTION****TEST OR INSPECTION****CORRECTIVE ACTION**

- Step 11. Connect valve control wire harness connector to driver main inlet valve motor. Disconnect valve control wire harness connector from TANK FILL & RE-CIRCULATING valve control. Connect driver main inlet valve control wire harness connector to TANK FILL & RE-CIRCULATING valve control. While an assistant pushes pump operator's panel TANK FILL & RE-CIRCULATING valve control OPEN and CLOSE buttons (WP 0004), check if driver main inlet valve operates.
- a. If driver main inlet valve operates, reconnect valve control wire harnesses to original positions and replace DRIVER MAIN INLET valve control (WP 0418).
  - b. If driver main inlet valve does not operate, reconnect valve control wire harnesses to original positions and replace driver main inlet valve motor (WP 0388).

## MALFUNCTION

## TEST OR INSPECTION

## CORRECTIVE ACTION

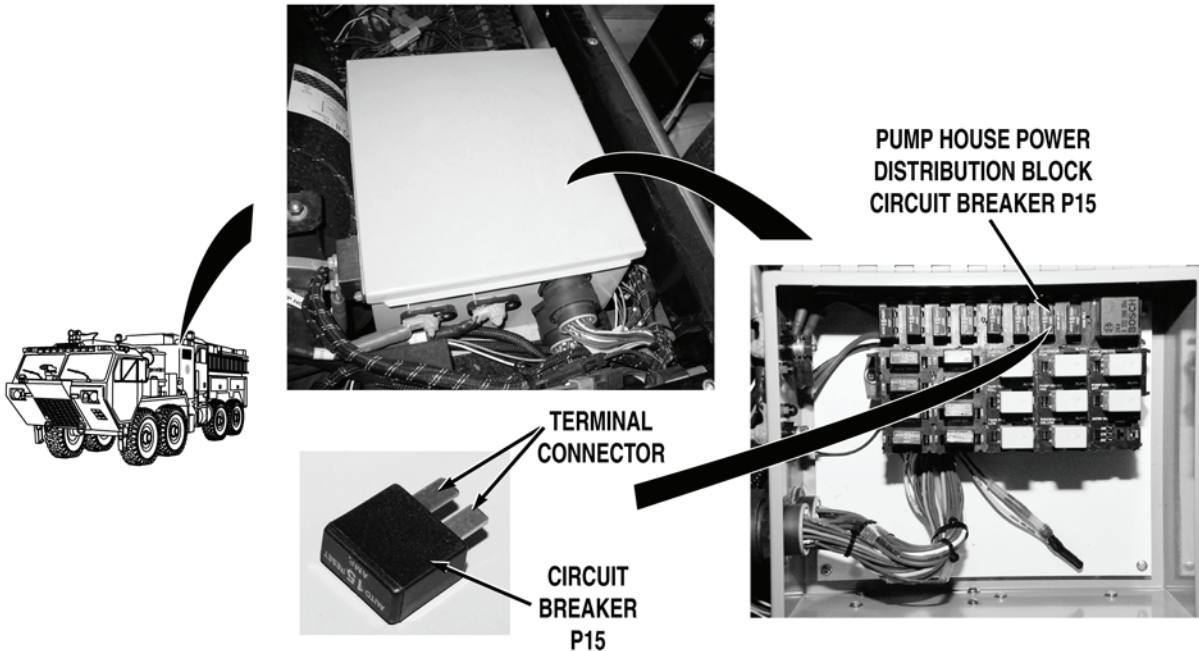
**WARNING**

Remove rings, wristwatches, neck chains, and any other jewelry before working around vehicle. Jewelry can catch on equipment and cause serious injury. Jewelry and tools may short across electrical circuits and cause damage to equipment, or severe burns or electrical shock to personnel.

- Step 12. Turn battery disconnect switch to OFF position (WP 0007). Remove pump house panel S (WP 0540). Open pump house power distribution (WP 0412). Remove circuit breaker P15 (WP 0412). Check for continuity across circuit breaker.

If there is no continuity, replace circuit breaker P15 (WP 0412).

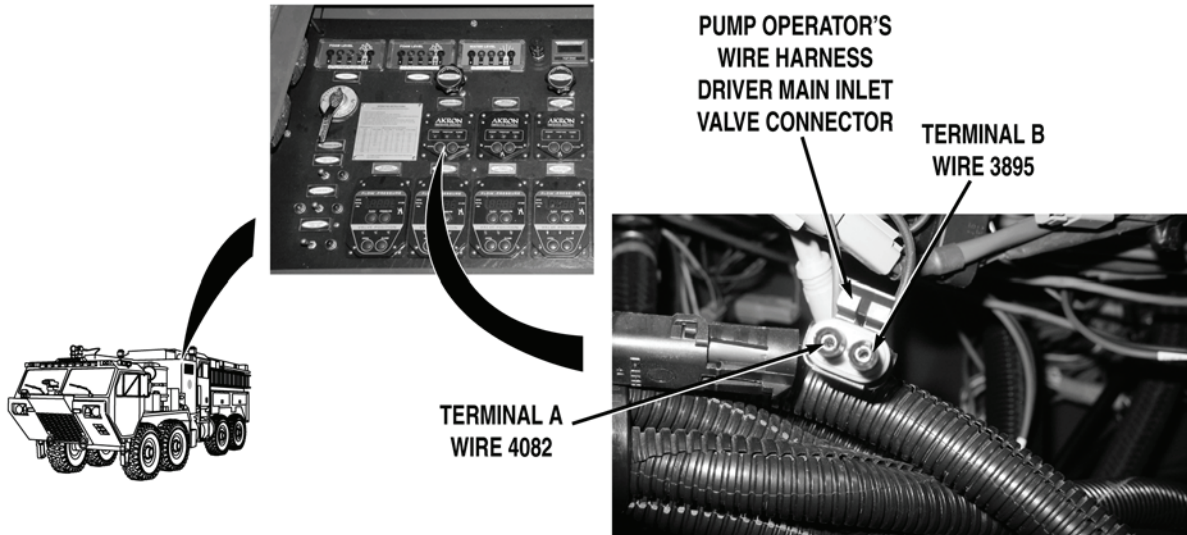

**MALFUNCTION****TEST OR INSPECTION****CORRECTIVE ACTION**

- Step 13. Install circuit breaker P15 (WP 0412). Open pump operator's panel housing (WP 0325). Disconnect pump operator's panel wire harness DRIVER MAIN INLET valve control connector. Turn battery disconnect switch to ON position (WP 0007). Check for 22 to 28 VDC between pump operator's panel wire harness wire 4082 (gray) at DRIVER MAIN INLET valve control connector, terminal A and a known good ground.

If 22 to 28 VDC are not present, go to Step 15.

- Step 14. Turn battery disconnect switch to OFF position (WP 0007). With a test lead set, check for continuity across wire 3895 (black) from pump operator's panel wire harness DRIVER MAIN INLET valve control connector, terminal B and a known good ground.
- a. If there is continuity, replace DRIVER MAIN INLET valve control (WP 0418).
  - b. If there is no continuity, repair wire 3895 in pump operator's panel wire harness if repairable (TM 9-2320-325-14&P), or replace pump operator's panel wire harness (WP 0459).

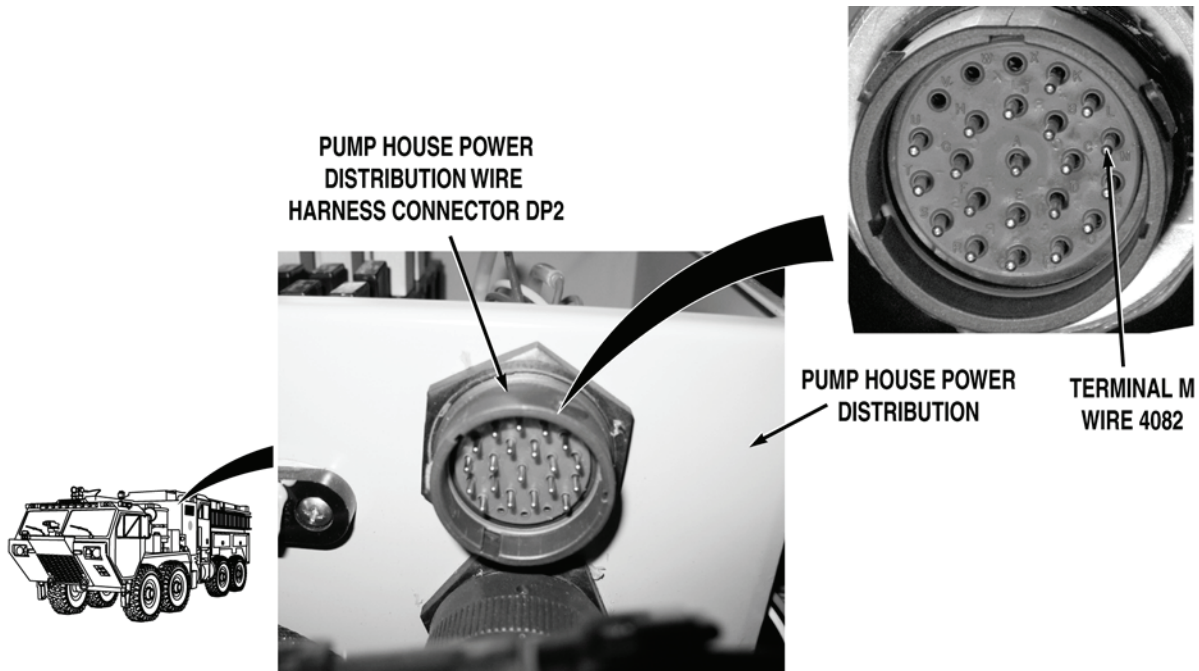
**MALFUNCTION****TEST OR INSPECTION****CORRECTIVE ACTION**

Step 15. Disconnect pump house wire harness pump house power distribution wire harness connector DP2. With a test lead set, check for 22 to 28 VDC between pump house power distribution wire harness wire 4082 (gray) at connector DP2, terminal M and a known good ground.

- a. If 22 to 28 VDC are not present, repair wire 4082 in pump house power distribution wire harness if repairable (TM 9-2320-325-14&P), or replace pump house power distribution wire harness and block (WP 0457).
- b. If 22 to 28 VDC are not present, repair wire 4082 (gray) in pump house wire harness if repairable (TM 9-2320-325-14&P), or replace pump house wire harness (WP 0458).

**END OF TASK****FOLLOW-ON MAINTENANCE**

Remove wheel chocks (TM 9-2320-347-10)

**END OF TASK****END OF WORK PACKAGE**

**FIELD LEVEL MAINTENANCE**

**DRIVER SIDE PRE-CONNECT A VALVE DOES NOT OPERATE PROPERLY**

**INITIAL SETUP:**

**Tools and Special Tools**

Lead Set, Test (WP 0622, Item 21)  
 Tool Kit, General Mechanic's: Automotive  
 (WP 0622, Item 27)

**Personnel Required**

MOS 63B Wheeled vehicle mechanic (2)

**References**

TM 9-2320-325-14&P  
 WP 0004  
 WP 0007  
 WP 0325  
 WP 0388  
 WP 0390

**References (continued)**

WP 0411  
 WP 0412  
 WP 0417  
 WP 0451  
 WP 0453  
 WP 0457  
 WP 0459  
 WP 0460  
 WP 0495  
 WP 0540

**Equipment Conditions**

Water pump engine OFF (WP 0022)  
 Engine OFF (TM 9-2320-347-10)  
 Wheels chocked (TM 9-2320-347-10)

**MALFUNCTION**

**TEST OR INSPECTION**

**CORRECTIVE ACTION**

**DRIVER SIDE PRE-CONNECT A VALVE DOES NOT OPERATE PROPERLY**

**MALFUNCTION**

**TEST OR INSPECTION**

**CORRECTIVE ACTION**

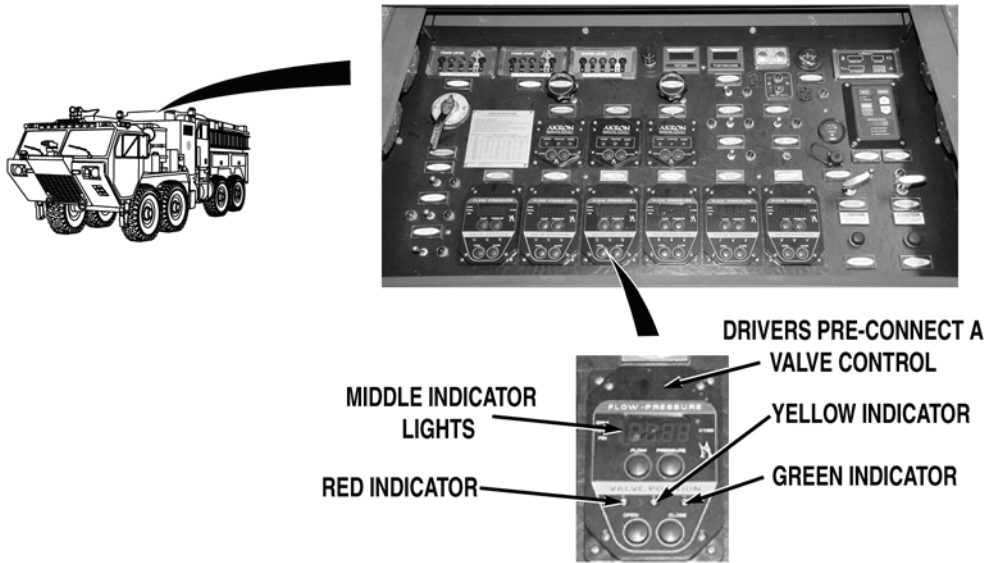

**NOTE**

Ensure batteries are fully charged before performing Step 1.

Step 1. Turn battery disconnect switch to ON position (WP 0007). Check if pump operator's panel DRIVERS PRE-CONNECT A valve control display illuminates.

If display is not illuminated, go to Step 17.

---

<b>MALFUNCTION</b>	<b>TEST OR INSPECTION</b>	<b>CORRECTIVE ACTION</b>
--------------------	---------------------------	--------------------------

---

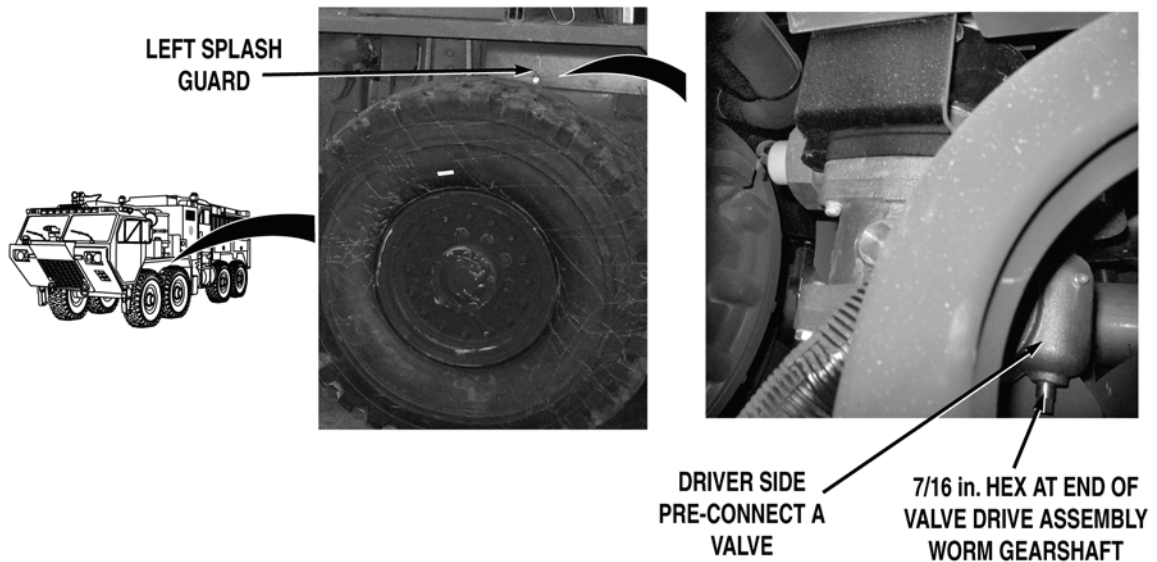
**NOTE**

- Valve operation can be checked either by noting vibration of valve assembly or by observing rotation of 7/16 in. hex at end of valve drive assembly worm gearshaft.
- Do not remove hose from driver side pre-connect A. Water may be released from system when valve is operated.

Step 2. Remove left splash guard (TM 9-2320-325-14&P). While an assistant pushes pump operator's panel DRIVERS PRE-CONNECT A valve control OPEN and CLOSE buttons (WP 0004), check if driver side pre-connect A valve operates.

If passenger side auxiliary inlet does not open and close, go to Step 9.

**MALFUNCTION**

**TEST OR INSPECTION**

**CORRECTIVE ACTION**

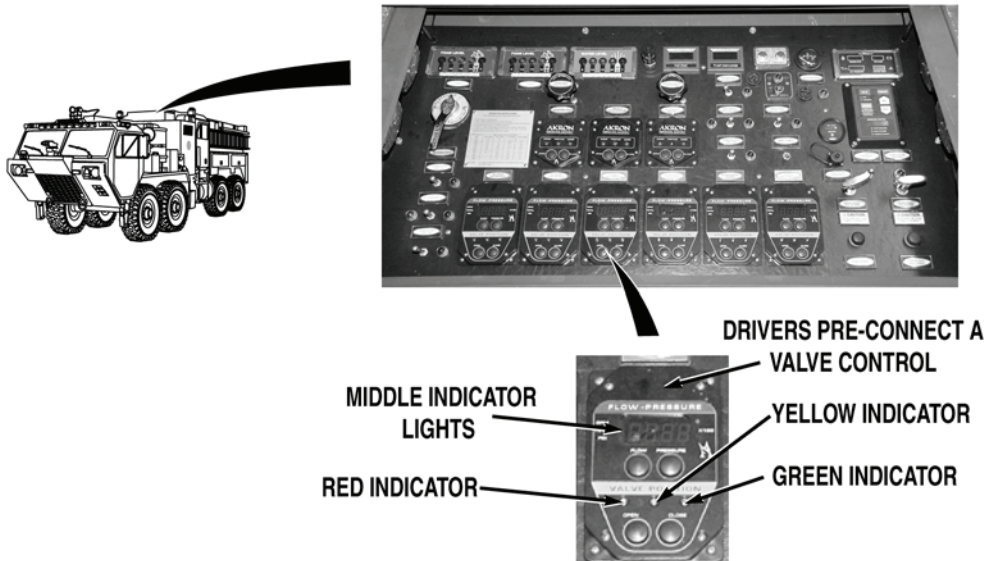

Step 3. While an assistant monitors operation of No. 3 passenger side discharge valve, push pump operator's panel DRIVERS PRE-CONNECT A valve control OPEN and CLOSE buttons (WP 0004). Check if DRIVERS PRE-CONNECT A valve control opened (green) and closed (red) indicators illuminate before No. 3 passenger side discharge valve is fully opened or closed.

If DRIVERS PRE-CONNECT A valve control indicators illuminate before drivers pre-connect A valve is fully opened or closed, go to Step 13.

---

<b>MALFUNCTION</b>	<b>TEST OR INSPECTION</b>	<b>CORRECTIVE ACTION</b>
--------------------	---------------------------	--------------------------

---

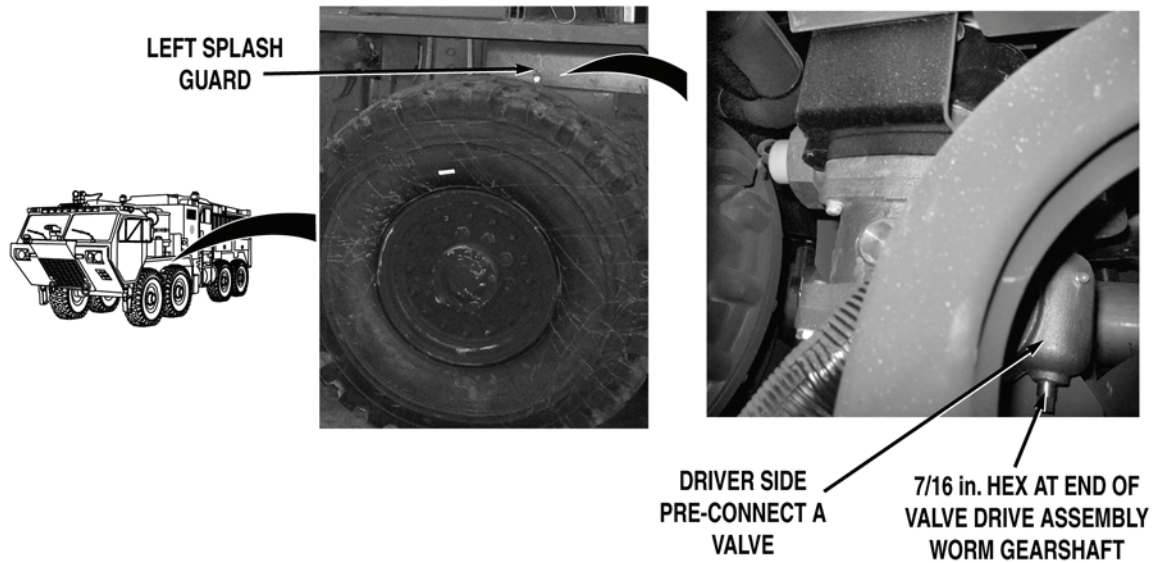
**NOTE**

Valve operation must be checked by observing rotation of 7/16 in. hex at end of valve drive assembly worm gearshaft for Step 4.

- Step 4. While an assistant pushes pump operator's panel DRIVERS PRE-CONNECT a valve control OPEN and CLOSE buttons (WP 0004), check if driver side pre-connect A valve worm gearshaft moves excessively after valve is fully opened or closed.

If driver side pre-connect A valve worm gearshaft moves excessively after valve is fully opened or closed, replace driver side pre-connect A valve motor (WP 0388), ensuring all mounting hardware is secure.

**MALFUNCTION**

**TEST OR INSPECTION**

**CORRECTIVE ACTION**

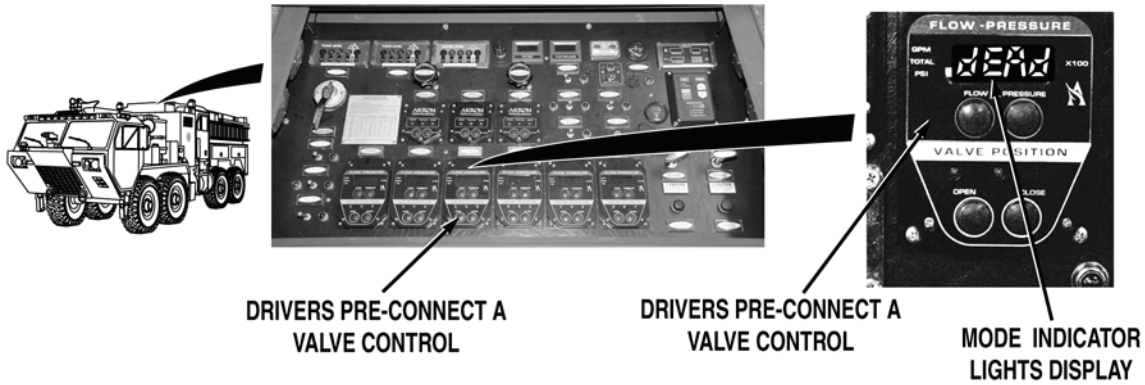

Step 5. Push pump operator's panel DRIVER SIDE PRE-CONNECT A valve control PRESSURE button. Check if dEAd error is indicated in mode indicator lights display.

If dEAd error message is displayed, replace DRIVER SIDE PRE-CONNECT A valve control (WP 0417).

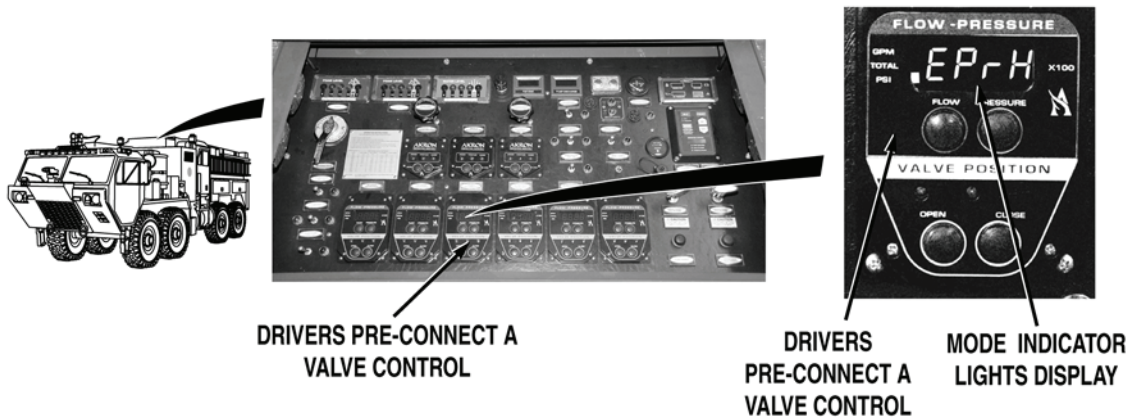

Step 6. Check if EPrL or EPrH error is indicated in mode indicator lights display.

If EPrL or EPrH error message is displayed, go to Step 15.

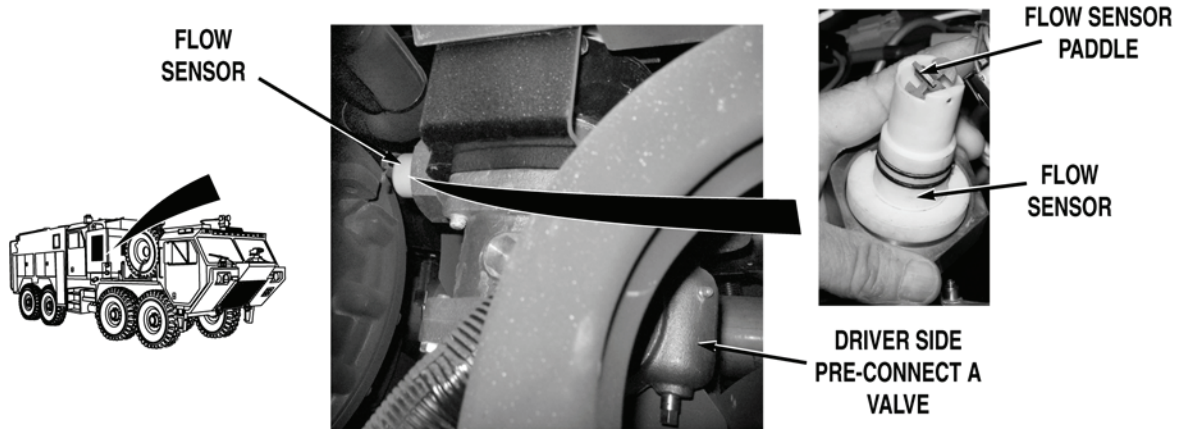

**MALFUNCTION****TEST OR INSPECTION****CORRECTIVE ACTION****WARNING**

Remove rings, wristwatches, neck chains, and any other jewelry before working around vehicle. Jewelry can catch on equipment and cause serious injury. Jewelry and tools may short across electrical circuits and cause damage to equipment, or severe burns or electrical shock to personnel.

- Step 7. Remove driver side pre-connect A valve flow sensor (WP 0390). Do not disconnect wires from sensor. Push pump operator's panel DRIVER SIDE PRE-CONNECT A valve control FLOW button. While an assistant spins flow sensor paddle, check if a flow reading is displayed when flow sensor paddle is spinning.

If a reading of 0 gpm (0 lpm) is displayed when flow sensor paddle is spinning, go to Step 16.

---

**MALFUNCTION****TEST OR INSPECTION****CORRECTIVE ACTION**

---

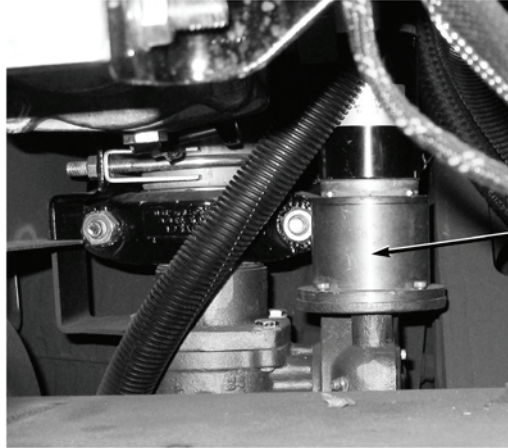

**DRIVER SIDE  
PRE-CONNECT A  
VALVE**

Step 8. Install driver side pre-connect A valve flow sensor (WP 0390). Remove driver side pre-connect A valve (WP 0495) and inspect for damage and contamination.

- a. If driver side pre-connect A valve is free from damage and contamination, reinstall valve (WP 0495) and go to Step 9.
- b. If driver side pre-connect A valve is damaged and/or contaminated, replace driver side pre-connect A (WP 0495).

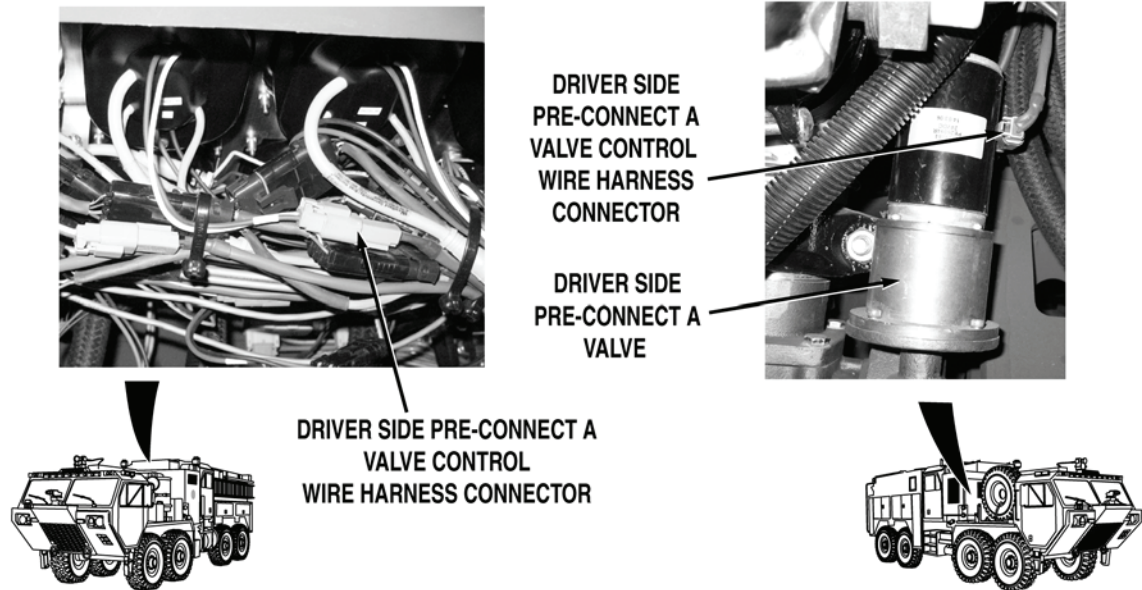
**MALFUNCTION****TEST OR INSPECTION****CORRECTIVE ACTION**

- Step 9. Open pump operator's panel housing (WP 0325). Check driver side pre-connect A valve control wire harness at DRIVER SIDE PRE-CONNECT A valve control and driver side pre-connect A valve motor for loose connections.

If driver side pre-connect A valve control wire harness connectors are loose, reconnect loose connectors (WP 0453).

**NOTE**

- Engine may have to be running to provide enough power to operate valve control. Valve will operate with less voltage, but only yellow indicator light will register on valve control.
- Do not engage water pump engine during this procedure. Valve operations can be checked without water pump operation.
- Valve motor operation can be checked by noting vibration of valve assembly, or by observing rotation of 7/16 in. hex at end of valve drive assembly worm gearshaft.

- Step 10. Remove pump house panel D (WP 0540). While an assistant pushes pump operator's panel DRIVER SIDE PRE-CONNECT A valve control OPEN and CLOSE buttons (WP 0004), check if DRIVER SIDE PRE-CONNECT A valve control yellow indicator illuminates and driver side pre-connect A valve motor operates.

If indicator illuminates and valve motor operates, replace driver side pre-connect A valve drive assembly (WP 0388).

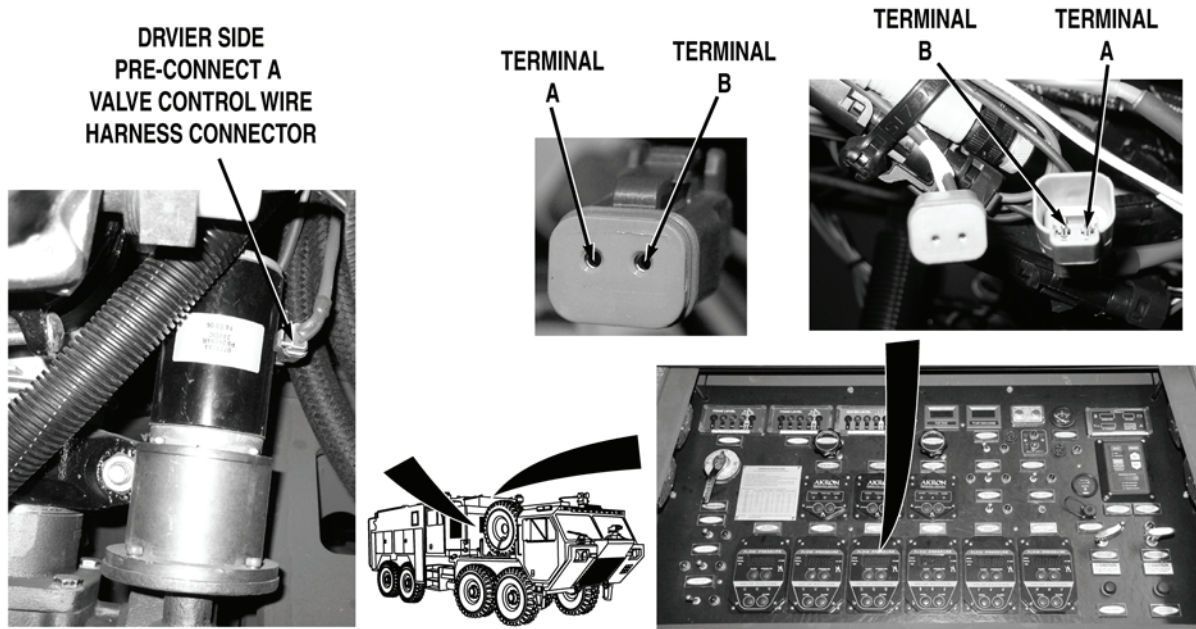
**MALFUNCTION****TEST OR INSPECTION****CORRECTIVE ACTION****WARNING**

**Remove rings, wristwatches, neck chains, and any other jewelry before working around vehicle. Jewelry can catch on equipment and cause serious injury. Jewelry and tools may short across electrical circuits and cause damage to equipment, or severe burns or electrical shock to personnel.**

- Step 11. Turn battery disconnect switch to OFF position (WP 0007). Disconnect driver side pre-connect A valve control wire harness connector from DRIVER SIDE PRE-CONNECT A valve control. Disconnect driver side pre-connect A valve control wire harness connector from driver side pre-connect A valve motor. With a test lead set, check for continuity across discharge valve control wire harness from terminal to terminal.

If there is no continuity, repair driver side pre-connect A valve control wire harness if repairable (TM 9-2320-325-14&P), or replace driver side pre-connect A valve control wire harness (WP 0453).

---

<b>MALFUNCTION</b>	<b>TEST OR INSPECTION</b>	<b>CORRECTIVE ACTION</b>
--------------------	---------------------------	--------------------------

---



**DRIVER PRE-CONNECT A  
CONTROL VALVE WIRE  
HARNESS CONNECTOR  
(RED AND BLACK)**

**NO. 3 PASSENGER SIDE  
DISCHARGE VALVE CONTROL  
WIRE HARNESS CONNECTOR  
(BLUE AND WHITE)**

- Step 12. Connect driver side pre-connect A valve control wire harness connector to driver side pre-connect A valve motor. Disconnect No. 3 passenger side discharge valve control wire harness connector from NO. 3 PASSENGER SIDE DISCHARGE valve control. Connect driver side pre-connect A valve control wire harness connector to NO. 3 PASSENGER SIDE DISCHARGE valve control. Turn battery disconnect switch to ON position (WP 0007). While an assistant pushes pump operator's panel NO. 3 PASSENGER SIDE DISCHARGE valve control OPEN and CLOSE buttons (WP 0004), check if driver side pre-connect A valve operates.
- a. If driver side pre-connect A valve operates, reconnect valve control wire harness connectors to original positions and replace DRIVER SIDE PRE-CONNECT A valve control (WP 0417).
  - b. If driver side pre-connect A valve does not operate, reconnect valve control wire harness connectors to original positions and replace driver side pre-connect A valve motor (WP 0388).

## MALFUNCTION

## TEST OR INSPECTION

## CORRECTIVE ACTION

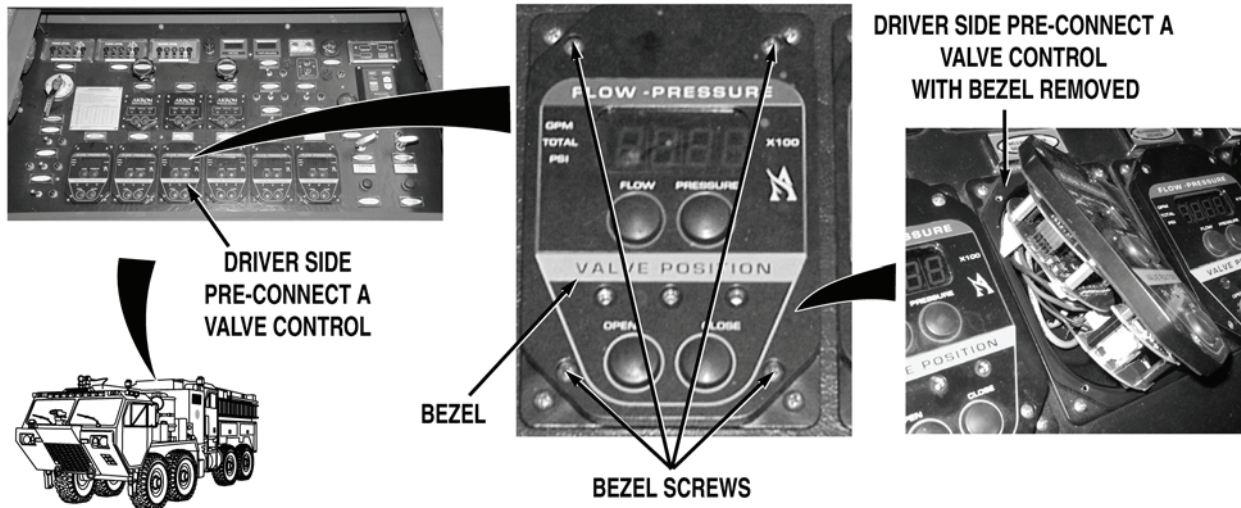

- Step 13. Remove four screws and bezel from pump operator's panel DRIVER SIDE PRE-CONNECT A valve control. Check for signs of water and moisture damage.

If DRIVER SIDE PRE-CONNECT A valve control shows evidence of water and moisture damage, replace DRIVER SIDE PRE-CONNECT A valve control (WP 0417).

- Step 14. Install bezel and four screws on DRIVER SIDE PRE-CONNECT A valve control. Remove driver side pre-connect A valve (WP 0495) and inspect it for binding, damage, and contamination.
- a. If driver side pre-connect A valve is free from binding, damage, and contamination, reinstall valve (WP 0495) and replace driver side pre-connect A valve motor and drive assembly (WP 0388).
  - b. If driver side pre-connect A valve is binding, damaged, and/or contaminated, replace driver side pre-connect A valve (WP 0495).

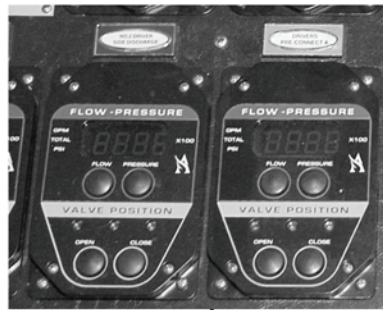
**MALFUNCTION****TEST OR INSPECTION****CORRECTIVE ACTION**

DRIVERS  
PRE-CONNECT A  
VALE CONTROL

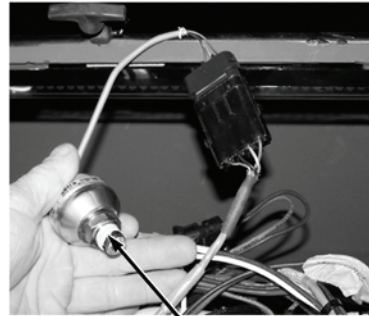

PRESSURE  
TRANSDUCER

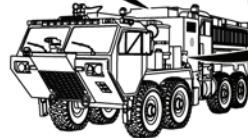

DRIVER SIDE  
PRE-CONNECT A  
PRESSURE TRANSDUCER

**WARNING**

Remove rings, wristwatches, neck chains, and any other jewelry before working around vehicle. Jewelry can catch on equipment and cause serious injury. Jewelry and tools may short across electrical circuits and cause damage to equipment, or severe burns or electrical shock to personnel.

- Step 15. Remove driver side pre-connect A valve pressure transducer (WP 0411). Disconnect driver side pre-connect A valve pressure transducer wire harness from DRIVER SIDE PRE-CONNECT A valve control. Connect pressure transducer to DRIVER SIDE PRE-CONNECT A valve control (removing wire harness from circuit). Check if error message EPrL or EPrH is displayed.
- a. If EPrL or EPrH error message is displayed, replace driver side pre-connect A valve discharge pressure transducer (WP 0411).
  - b. If EPrL or EPrH error message is not displayed, repair pressure transducer wire harness if repairable (TM 9-2320-325-14&P), or replace driver side pre-connect A valve pressure transducer wire harness (WP 0460).

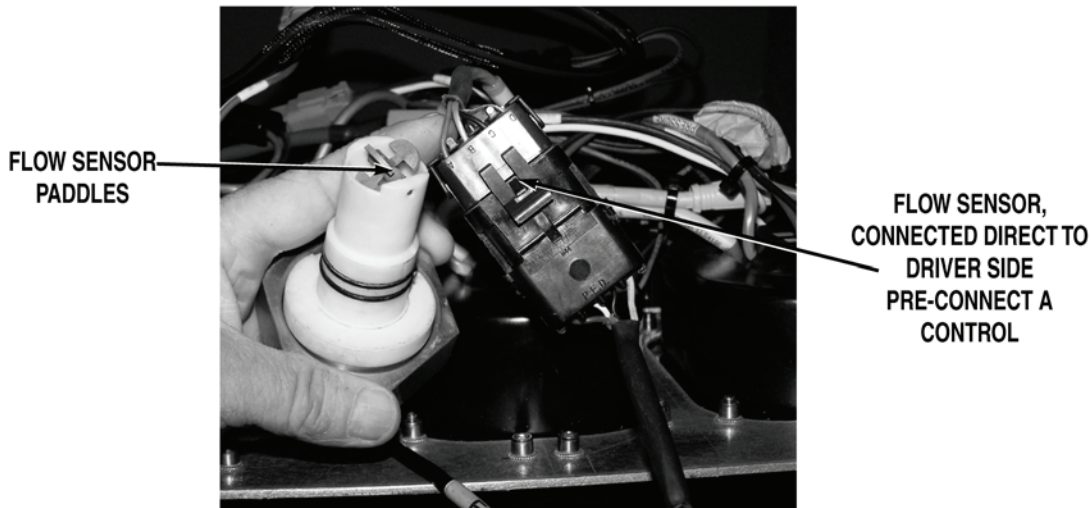
**MALFUNCTION****TEST OR INSPECTION****CORRECTIVE ACTION****WARNING**

**Remove rings, wristwatches, neck chains, and any other jewelry before working around vehicle. Jewelry can catch on equipment and cause serious injury. Jewelry and tools may short across electrical circuits and cause damage to equipment, or severe burns or electrical shock to personnel.**

- Step 16. Disconnect driver side pre-connect A valve flow sensor wire harness from driver side pre-connect A flow sensor. Disconnect driver side pre-connect A valve flow sensor wire harness from DRIVER SIDE PRE-CONNECT A valve control. Connect driver side pre-connect A flow sensor to DRIVER SIDE PRE-CONNECT A valve control (removing wire harness from circuit). While an assistant spins flow sensor paddle wheel, check if a flow reading is displayed when flow sensor paddle is spinning.
- a. If a flow reading is displayed when flow sensor paddle is spinning, repair flow sensor wire harness if repairable (TM 9-2320-325-14&P), or replace driver side pre-connect A valve flow sensor wire harness (WP 0451).
  - b. If a flow reading is not displayed when flow sensor paddle is spinning, replace driver side pre-connect A valve flow sensor (WP 0390).



## MALFUNCTION

## TEST OR INSPECTION

## CORRECTIVE ACTION

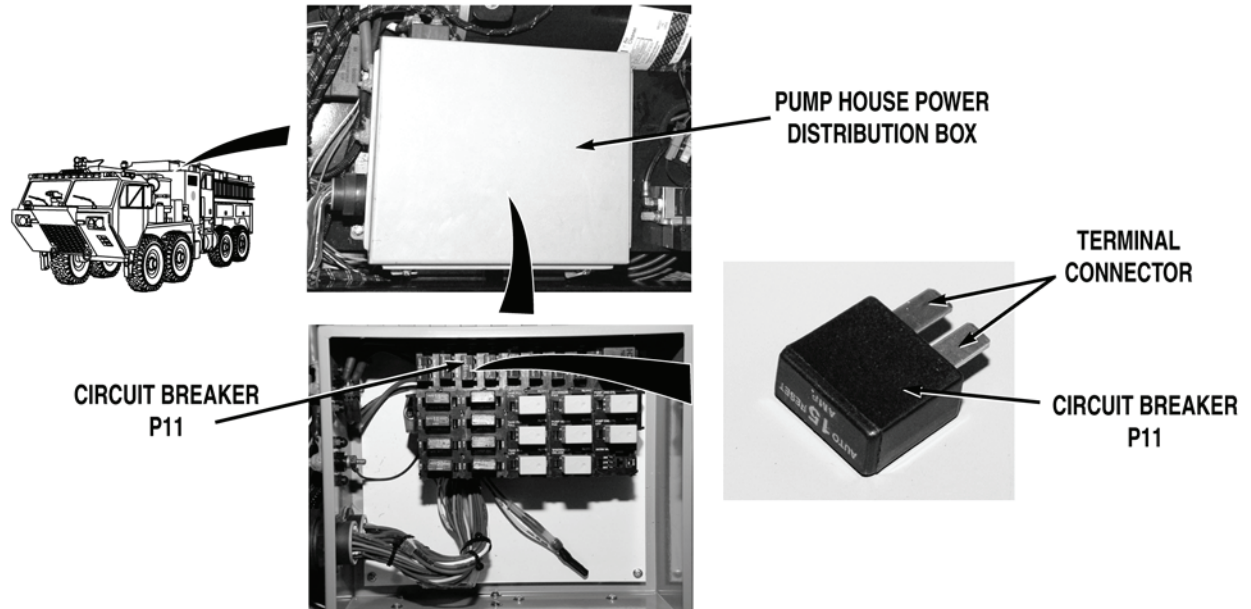
**WARNING**

Remove rings, wristwatches, neck chains, and any other jewelry before working around vehicle. Jewelry can catch on equipment and cause serious injury. Jewelry and tools may short across electrical circuits and cause damage to equipment, or severe burns or electrical shock to personnel.

- Step 17. Turn battery disconnect switch to OFF position (WP 0007). Remove pump house panel S (WP 0540). Open pump house power distribution (WP 0412). Remove circuit breaker P11 (WP 0412). Check for continuity across circuit breaker.

If there is no continuity, replace circuit breaker P11 (WP 0412).

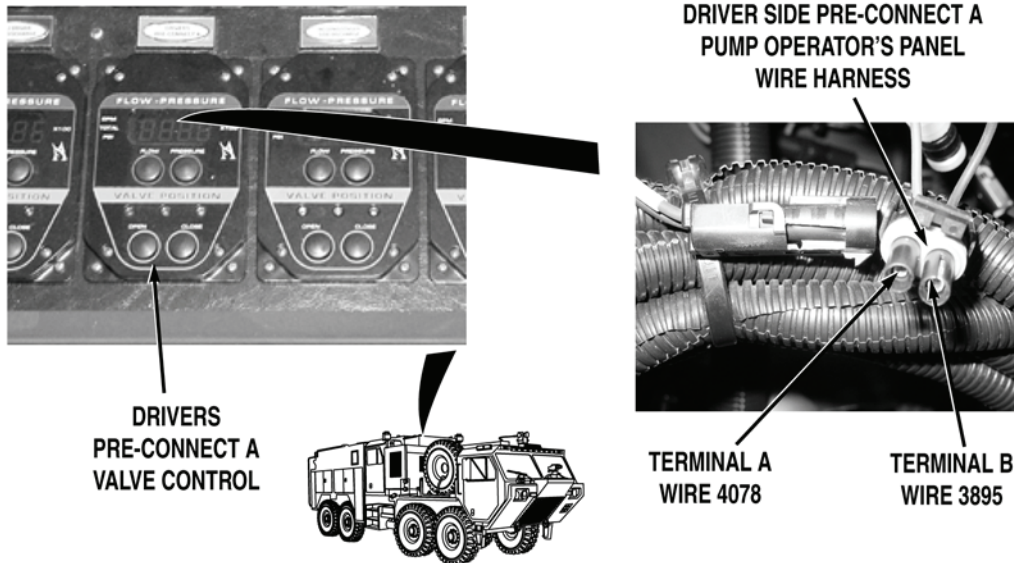
**MALFUNCTION****TEST OR INSPECTION****CORRECTIVE ACTION**

Step 18. Install circuit breaker P11 (WP 0412). Open pump operator's panel housing (WP 0325). Disconnect pump house wire harness DRIVER SIDE PRE-CONNECT A valve control connector. Turn battery disconnect switch to ON position (WP 0007). Check for 22 to 28 VDC between pump operator's panel wire harness wire 4078 (orange) at DRIVER SIDE PRE-CONNECT A valve control connector, terminal A and a known good ground.

If 22 to 28 VDC are not present, go to Step 20.

Step 19. Turn battery disconnect switch to OFF position (WP 0007). With a test lead set, check for continuity across wire 3895 (black) from pump operator's panel DRIVER SIDE PRE-CONNECT A valve control connector, terminal B and a known good ground.

- a. If there is continuity, replace DRIVER SIDE PRE-CONNECT A valve control (WP 0417).
- b. If there is no continuity, repair wire 3895 in pump operator's panel wire harness if repairable (TM 9-2320-325-14&P), or replace pump operator's panel wire harness (WP 0459).

**MALFUNCTION****TEST OR INSPECTION****CORRECTIVE ACTION**

- Step 20. Turn battery disconnect switch to OFF position (WP 0007). Disconnect pump operator's panel wire harness pump house power distribution wire harness connector DP2. Turn battery disconnect switch to ON position (WP 0007). With a test lead set, check for 22 to 28 VDC between pump house power distribution wire harness wire 4078 (orange) at connector DP2, terminal H and a known good ground.
- a. If 22 to 28 VDC are present, repair wire 4078 in pump house wire harness if repairable (TM 9-2320-325-14&P), or replace pump operator's panel wire harness (WP 0459).
  - b. If 22 to 28 VDC are not present, repair wire 4078 in pump house power distribution wire harness if repairable (TM 9-2320-325-14&P), or replace pump house power distribution wire harness and block (WP 0457).

**END OF TASK****FOLLOW-ON MAINTENANCE**

Remove wheel chocks (TM 9-2320-347-10)

**END OF TASK****END OF WORK PACKAGE**



**FIELD LEVEL MAINTENANCE**

**DRIVER SIDE PRE-CONNECT B VALVE DOES NOT OPERATE PROPERLY**

**INITIAL SETUP:**

**Tools and Special Tools**

Lead Set, Test (WP 0622, Item 21)  
 Tool Kit, General Mechanic's: Automotive  
 (WP 0622, Item 27)

**Personnel Required**

MOS 63B Wheeled vehicle mechanic (2)

**References**

TM 9-2320-325-14&P  
 WP 0004  
 WP 0007  
 WP 0325  
 WP 0388  
 WP 0390  
 WP 0411

**References (continued)**

WP 0412  
 WP 0417  
 WP 0451  
 WP 0453  
 WP 0457  
 WP 0459  
 WP 0460  
 WP 0496  
 WP 0540

**Equipment Conditions**

Water pump engine OFF (WP 0022)  
 Engine OFF (TM 9-2320-347-10)  
 Wheels chocked (TM 9-2320-347-10)

**MALFUNCTION**

**TEST OR INSPECTION**

**CORRECTIVE ACTION**

**DRIVER SIDE PRE-CONNECT B VALVE DOES NOT OPERATE PROPERLY**

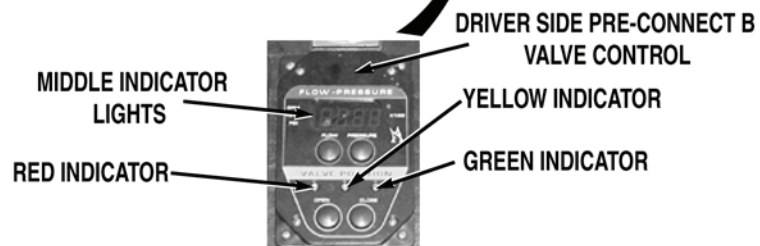
**MALFUNCTION****TEST OR INSPECTION****CORRECTIVE ACTION****NOTE**

Ensure batteries are fully charged before performing Step 1.

- Step 1. Turn battery disconnect switch to ON position (WP 0007). Check if pump operator's panel DRIVER SIDE PRE-CONNECT B valve control display illuminates.

If display is not illuminated, go to Step 17.

---

<b>MALFUNCTION</b>	
<b>TEST OR INSPECTION</b>	
<b>CORRECTIVE ACTION</b>	

---

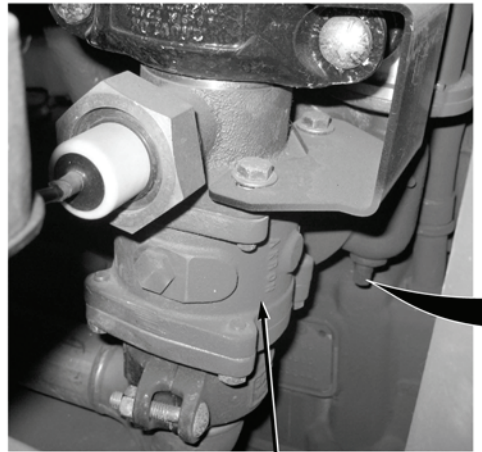

**DRIVER SIDE  
PRE-CONNECT B VALVE**

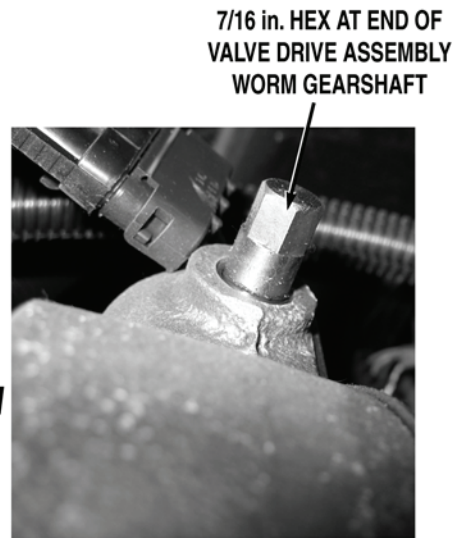

### NOTE

- Valve operation can be checked by noting vibration of valve assembly or by observing rotation of 7/16 in. hex at end of valve drive assembly worm gearshaft.
- Do not remove hose from driver side pre-connect B connector. Water may be released from system when valve is operated.

Step 2. Remove pump house panel G (WP 0540). While an assistant pushes pump operator's panel DRIVER SIDE PRE-CONNECT B valve control OPEN and CLOSE buttons (WP 0004), check if driver side pre-connect B valve operates to open and close positions.

If driver side pre-connect B valve does not open and close, go to Step 9

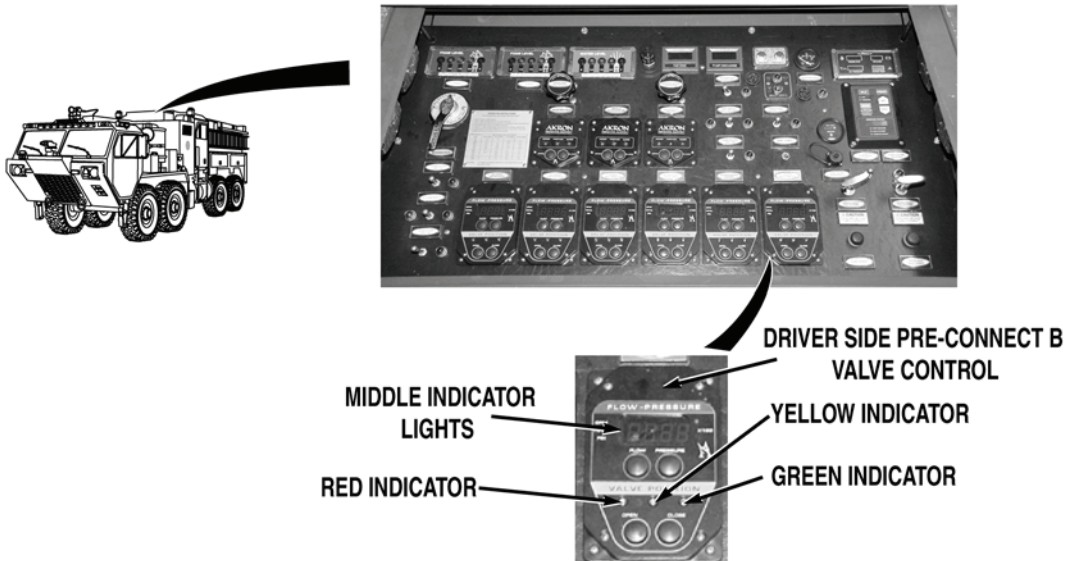
**MALFUNCTION****TEST OR INSPECTION****CORRECTIVE ACTION**

- Step 3. While an assistant monitors operation of driver side pre-connect B valve, push pump operator's panel DRIVER SIDE PRE-CONNECT B valve control OPEN and CLOSE buttons (WP 0004). Check if DRIVER SIDE PRE-CONNECT B valve control opened (green) and closed (red) indicators illuminate before driver side pre-connect B valve is fully opened or closed.

If DRIVER SIDE PRE-CONNECT B valve control indicators illuminate before driver side pre-connect B valve is fully opened or closed, go to Step 13

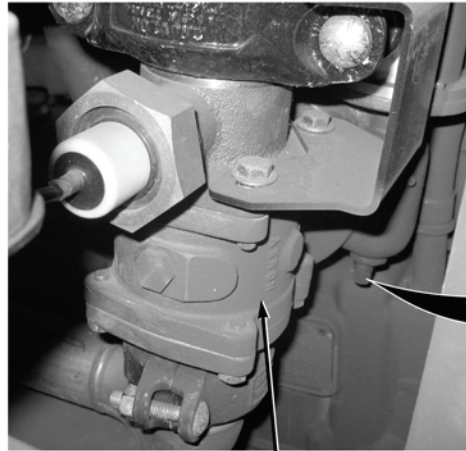

**MALFUNCTION****TEST OR INSPECTION****CORRECTIVE ACTION**

**DRIVER SIDE  
PRE-CONNECT B VALVE**

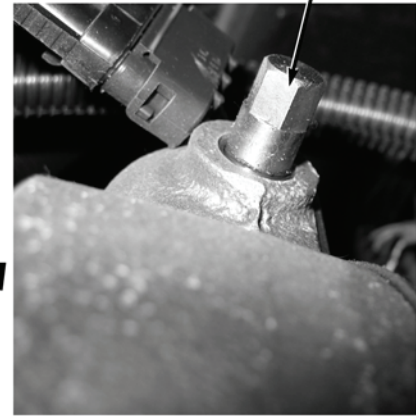

**7/16 in. HEX AT END OF  
VALVE DRIVE ASSEMBLY  
WORM GEARSHAFT**

**NOTE**

Valve operation must be checked by observing rotation of 7/16 in. hex at end of valve drive assembly worm gearshaft for Step 4

- Step 4. While an assistant pushes pump operator's panel DRIVER SIDE PRE-CONNECT B valve control OPEN and CLOSE buttons (WP 0004), check if driver side pre-connect B valve worm gearshaft moves excessively after valve is fully opened or closed.

If driver side pre-connect B valve worm gearshaft moves excessively after valve is fully opened or closed, remove and replace driver side pre-connect B valve motor (WP 0388), ensuring all mounting hardware is secure.

**MALFUNCTION**

**TEST OR INSPECTION**

**CORRECTIVE ACTION**

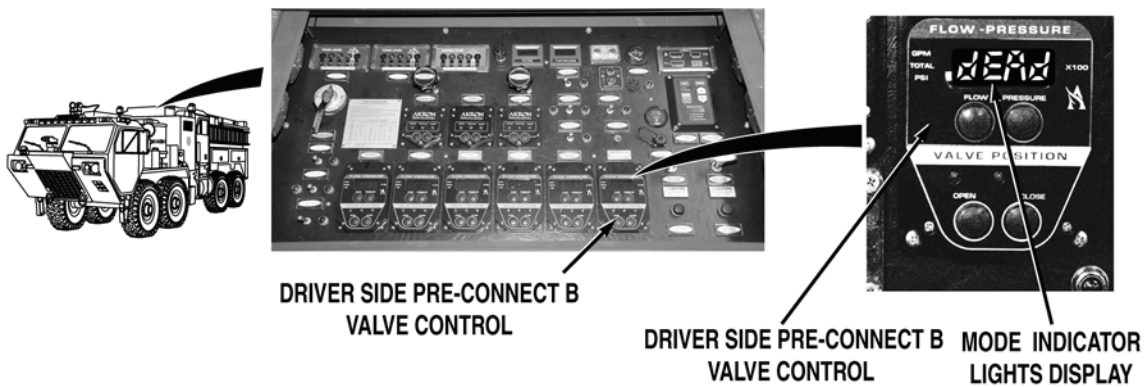

Step 5. Push pump operator's panel DRIVER SIDE PRE-CONNECT B valve control PRESSURE button. Check if dEAd error is indicated in mode indicator lights display.

If dEAd error message is displayed, replace DRIVER SIDE PRE-CONNECT B valve control (WP 0417).



Step 6. Check if EPrL or EPrH error is indicated in mode indicator lights display.

If EPrL or EPrH error message is displayed, go to Step 15

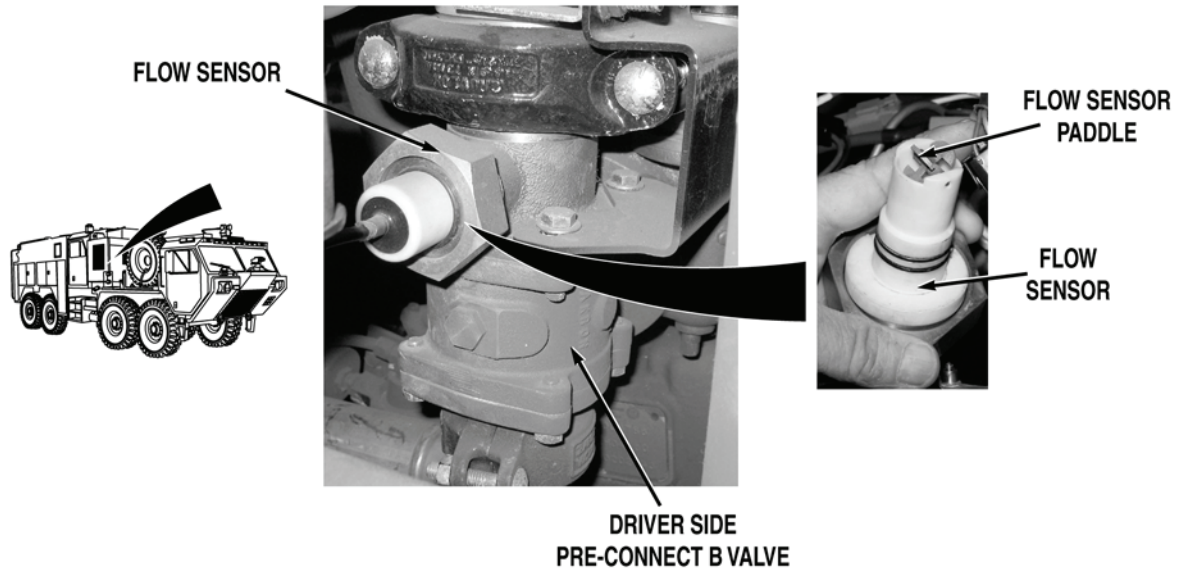
**MALFUNCTION****TEST OR INSPECTION****CORRECTIVE ACTION****WARNING**

Remove rings, wristwatches, neck chains, and any other jewelry before working around vehicle. Jewelry can catch on equipment and cause serious injury. Jewelry and tools may short across electrical circuits and cause damage to equipment, or severe burns or electrical shock to personnel.

- Step 7. Remove driver side pre-connect B valve flow sensor (WP 0390). Do not disconnect wires from sensor. Push pump operator's panel DRIVER SIDE PRE-CONNECT B valve control FLOW button. While an assistant spins flow sensor paddle, check if a flow reading is displayed when flow sensor paddle is spinning.

If a reading of 0 gpm (0 lpm) is displayed when flow sensor paddle is spinning, go to Step 16

---

**MALFUNCTION****TEST OR INSPECTION****CORRECTIVE ACTION**

---

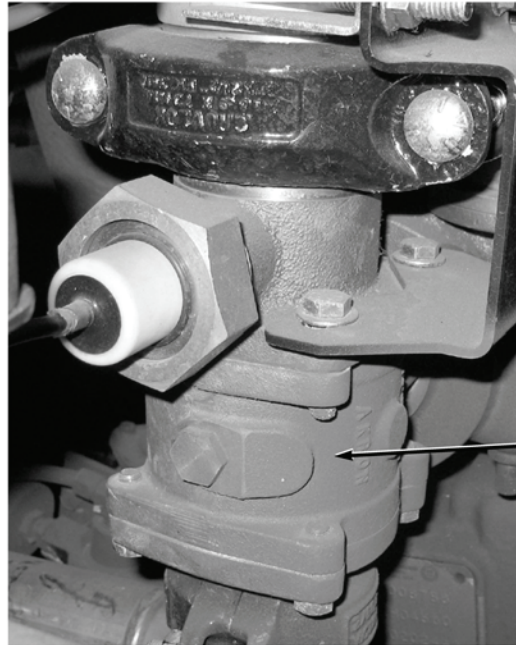

DRIVER SIDE  
PRE-CONNECT B  
VALVE

Step 8. Install driver side pre-connect B valve flow sensor (WP 0390). Remove driver side pre-connect B valve (WP 0496) and inspect for damage and contamination.

- a. If driver side pre-connect B valve is free from damage and contamination, reinstall valve (WP 0496) and go to Step 9
- b. If driver side pre-connect B valve is damaged and/or contaminated, replace driver side pre-connect B valve (WP 0496).

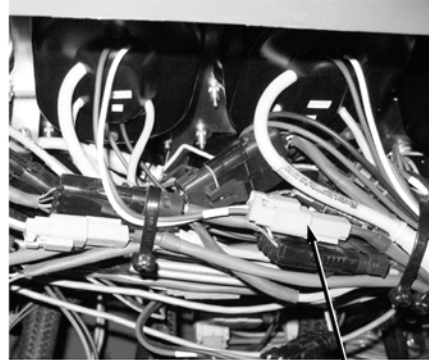
**MALFUNCTION****TEST OR INSPECTION****CORRECTIVE ACTION**

**DRIVER SIDE  
PRE-CONNECT B  
CONTROL VALVE  
WIRE HARNESS  
CONNECTOR**

**DRIVER SIDE  
PRE-CONNECT B  
VALVE CONTROL  
WIRE HARNESS  
CONNECTOR**

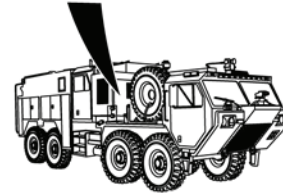
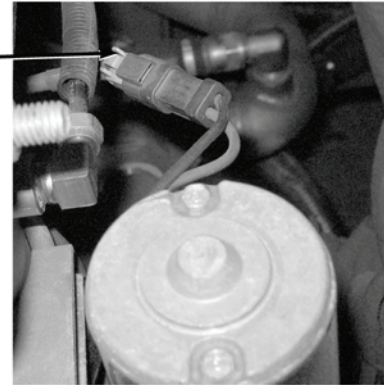

- Step 9. Open pump operator's panel housing (WP 0325). Check driver side pre-connect B valve control wire harness at DRIVER SIDE PRE-CONNECT B valve control and driver side pre-connect B valve motor for loose connections.

If driver side pre-connect B valve control wire harness connectors are loose, reconnect loose connectors (WP 0453).

**NOTE**

- Engine may have to be running to provide enough power to operate valve control. Valve will operate with less voltage, but only yellow indicator light will register on valve control.
- Do not engage water pump engine during this procedure. Valve operations can be checked without water pump operation.
- Valve motor operation can be checked by noting vibration of valve assembly, or by observing rotation of 7/16 in. hex at end of valve drive assembly worm gearshaft.
- Do not remove hose from DRIVER SIDE PRE-CONNECT B. Water may be released from system when valve is operated.

- Step 10. While an assistant pushes pump operator's panel DRIVER SIDE PRE-CONNECT B valve control OPEN and CLOSE buttons (WP 0004), check if DRIVER SIDE PRE-CONNECT B valve control yellow indicator illuminates and driver side pre-connect B valve motor operates.

If indicator illuminates and valve motor operates, replace driver side pre-connect B valve drive assembly (WP 0388).

**MALFUNCTION**

**TEST OR INSPECTION**

**CORRECTIVE ACTION**

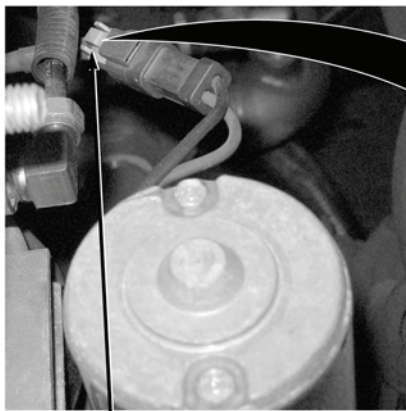

**DRIVER SIDE  
PRE-CONNECT B  
VALVE CONTROL  
WIRE HARNESS  
CONNECTOR**



**TERMINAL A      TERMINAL B**

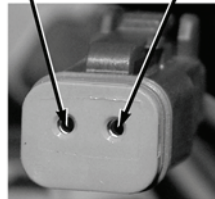

**TERMINAL B      TERMINAL A**

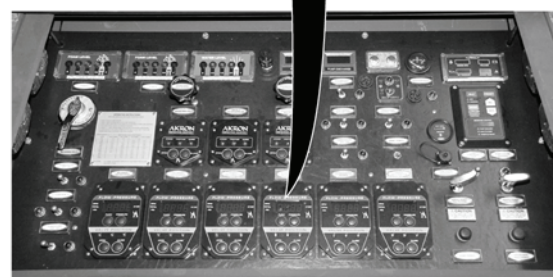
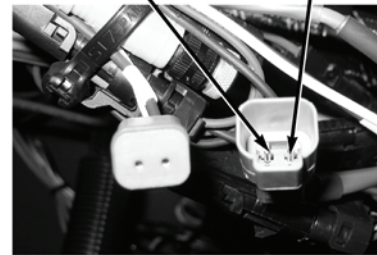

**WARNING**



**Remove rings, wristwatches, neck chains, and any other jewelry before working around vehicle. Jewelry can catch on equipment and cause serious injury. Jewelry and tools may short across electrical circuits and cause damage to equipment, or severe burns or electrical shock to personnel.**

- Step 11. Turn battery disconnect switch to OFF position (WP 0007). Disconnect driver side pre-connect B valve control wire harness connector from DRIVER SIDE PRE-CONNECT B valve control. Disconnect driver side pre-connect B valve control wire harness connector from driver side pre-connect B valve motor. With a test lead set, check for continuity across discharge valve control wire harness from terminal to terminal.

If there is no continuity, repair driver side pre-connect B valve control wire harness if repairable (TM 9-2320-325-14&P), or replace driver side pre-connect B valve control wire harness (WP 0453).

---

**MALFUNCTION**  
**TEST OR INSPECTION**  
**CORRECTIVE ACTION**

---

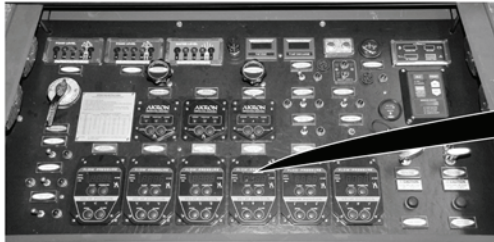

**NO. 4 PASSENGER SIDE  
DISCHARGE VALVE CONTROL  
WIRE HARNESS CONNECTOR  
(BLUE AND WHITE)**

**DRIVER SIDE  
PRE-CONNECT B VALVE CONTROL  
WIRE HARNESS CONNECTOR  
(RED AND BLACK)**

- Step 12. Connect driver side pre-connect B valve control wire harness connector to driver side pre-connect B valve motor. Disconnect No. 4 passenger side discharge valve control wire harness connector from No. 4 passenger side discharge valve control. Turn battery disconnect switch to ON position (WP 0007). Connect driver side pre-connect B valve control wire harness connector to NO. 4 PASSENGER SIDE DISCHARGE valve control. While an assistant pushes pump operator's panel NO. 4 PASSENGER SIDE DISCHARGE valve control OPEN and CLOSE buttons (WP 0004), check if driver side pre-connect B valve operates.
- a. If driver side pre-connect B valve operates, reconnect valve control wire harness connectors to original positions and replace DRIVER SIDE PRE-CONNECT B valve control (WP 0417).
  - b. If driver side pre-connect B valve does not operate, reconnect valve control wire harness connectors to original positions and replace driver side pre-connect B valve motor (WP 0388).

## MALFUNCTION

## TEST OR INSPECTION

## CORRECTIVE ACTION

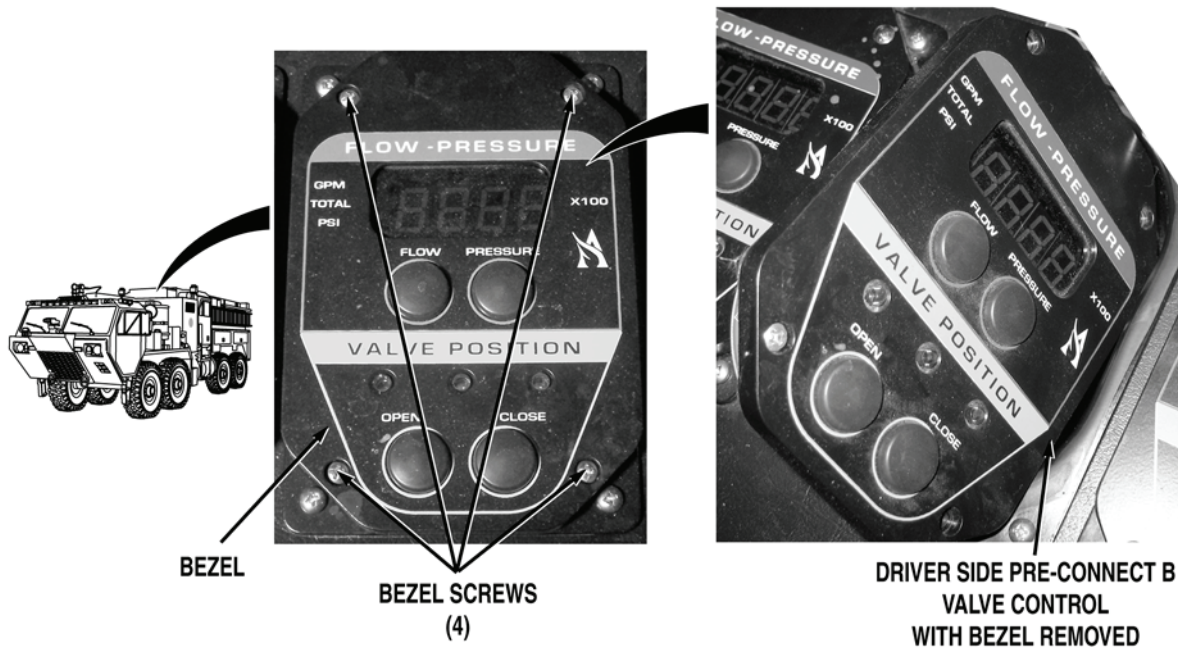

- Step 13. Remove four screws and bezel from pump operator's panel DRIVER SIDE PRE-CONNECT B valve control. Check for signs of water and moisture damage.

If DRIVER SIDE PRE-CONNECT B valve control shows evidence of water and moisture damage, replace DRIVER SIDE PRE-CONNECT B valve control (WP 0417).

- Step 14. Install bezel and four screws on DRIVER SIDE PRE-CONNECT B valve control. Remove driver side pre-connect B valve (WP 0496) and inspect it for binding, damage, and contamination.
- a. If driver side pre-connect B valve is free from binding, damage, and contamination, reinstall valve (WP 0496) and replace driver side pre-connect B valve motor and drive assembly (WP 0388).
  - b. If driver side pre-connect B valve is binding, damaged, and/or contaminated, replace driver side pre-connect B valve (WP 0496).



**MALFUNCTION**  
**TEST OR INSPECTION**  
**CORRECTIVE ACTION**

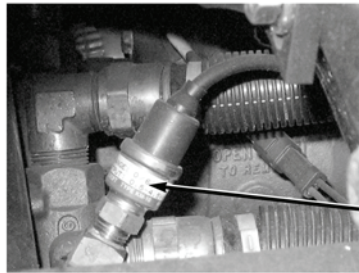

PRESSURE  
 TRANSDUCER

NO. 3 PASSENGER SIDE  
 DISCHARGE CONTROL  
 VALVE PRESSURE  
 TRANSDUCER CONNECTOR



PRESSURE TRANSDUCER

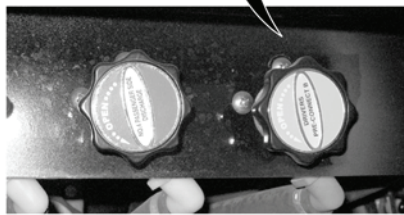

NO. 3 PASSENGER SIDE  
 DISCHARGE VALVE CONTROL

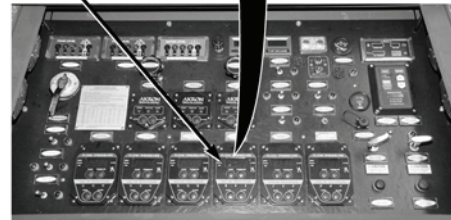

**WARNING**



**Remove rings, wristwatches, neck chains, and any other jewelry before working around vehicle. Jewelry can catch on equipment and cause serious injury. Jewelry and tools may short across electrical circuits and cause damage to equipment, or severe burns or electrical shock to personnel.**

- Step 15. Remove driver side pre-connect B valve pressure transducer (WP 0411). Disconnect driver side pre-connect B valve pressure transducer wire harness from DRIVER SIDE PRE-CONNECT B valve control. Connect pressure transducer to DRIVER SIDE PRE-CONNECT B valve control (removing wire harness from circuit). Check if error message EPrL or EPrH is displayed.
- a. If EPrL or EPrH error message is displayed, replace driver side pre-connect B valve discharge pressure transducer (WP 0411).
  - b. If EPrL or EPrH error message is not displayed, repair pressure transducer wire harness if repairable (TM 9-2320-325-14&P), or replace driver side pre-connect B valve pressure transducer wire harness (WP 0460).

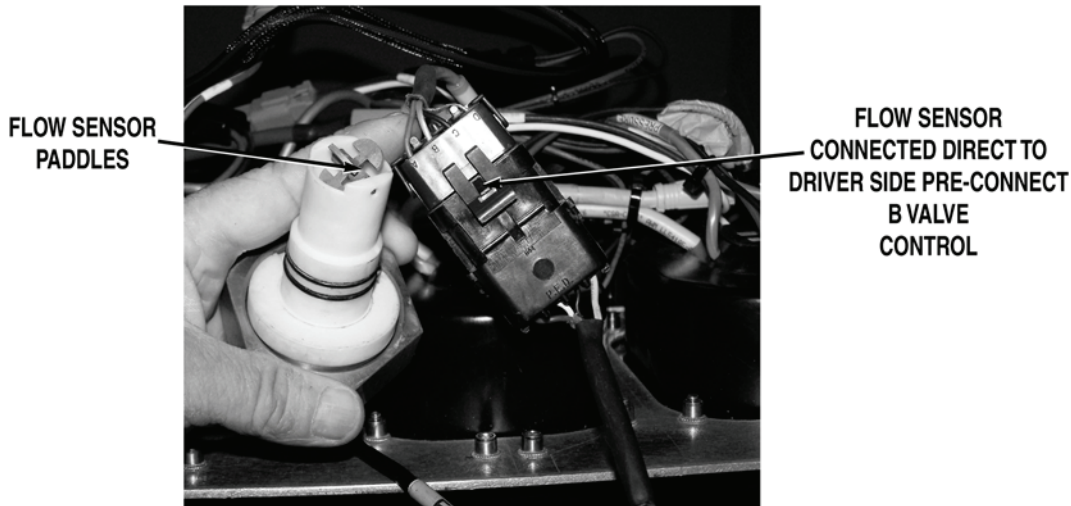
**MALFUNCTION****TEST OR INSPECTION****CORRECTIVE ACTION****WARNING**

**Remove rings, wristwatches, neck chains, and any other jewelry before working around vehicle. Jewelry can catch on equipment and cause serious injury. Jewelry and tools may short across electrical circuits and cause damage to equipment, or severe burns or electrical shock to personnel.**

- Step 16. Disconnect driver side pre-connect B valve flow sensor wire harness from driver side pre-connect B flow sensor. Disconnect driver side pre-connect B valve flow sensor wire harness from DRIVER SIDE PRE-CONNECT B valve control. Connect driver side pre-connect B flow sensor to DRIVER SIDE PRE-CONNECT B valve control (removing wire harness from circuit). While an assistant spins flow sensor paddle wheel, check if a flow reading is displayed when flow sensor paddle is spinning.
- a. If a flow reading is displayed when flow sensor paddle is spinning, repair flow sensor wire harness if repairable (TM 9-2320-325-14&P), or replace driver side pre-connect B valve flow sensor wire harness (WP 0451).
  - b. If a flow reading is not displayed when flow sensor paddle is spinning, replace driver side pre-connect B valve flow sensor (WP 0390).

## MALFUNCTION

## TEST OR INSPECTION

## CORRECTIVE ACTION

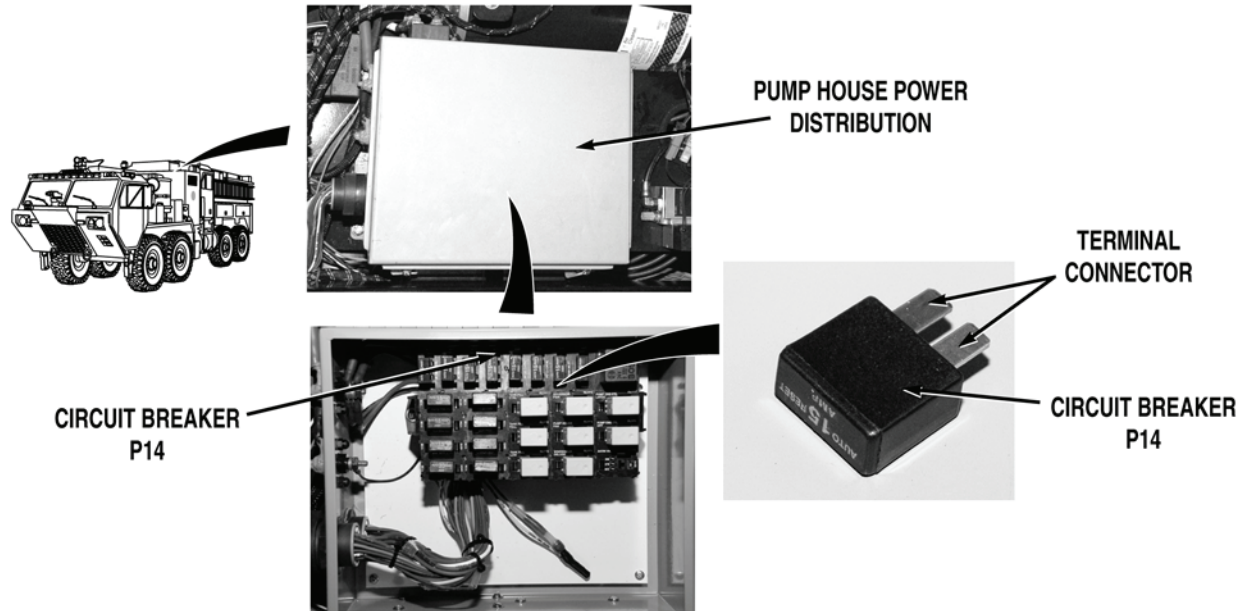
**WARNING**

Remove rings, wristwatches, neck chains, and any other jewelry before working around vehicle. Jewelry can catch on equipment and cause serious injury. Jewelry and tools may short across electrical circuits and cause damage to equipment, or severe burns or electrical shock to personnel.

- Step 17. Turn battery disconnect switch to OFF position (WP 0007). Remove pump house panel S (WP 0540). Open pump house power distribution (WP 0412). Remove circuit breaker P14 (WP 0412). Check for continuity across circuit breaker.

If there is no continuity, replace circuit breaker P14 (WP 0412).

## MALFUNCTION

## TEST OR INSPECTION

## CORRECTIVE ACTION

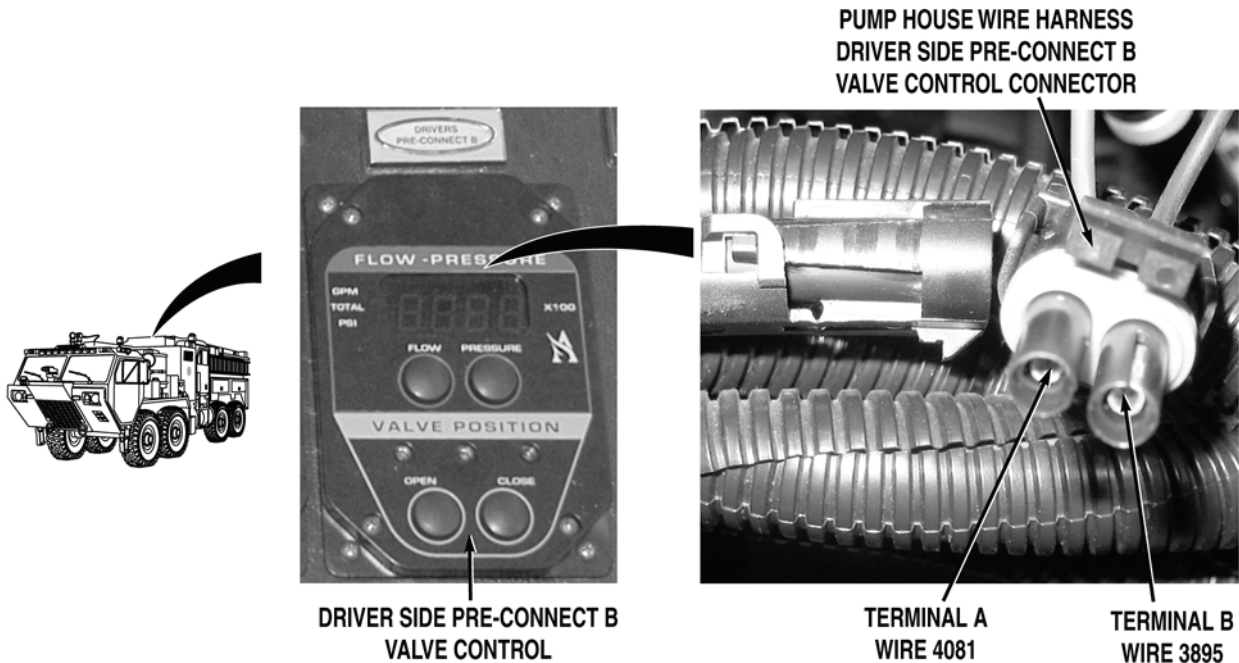

- Step 18. Install circuit breaker P14 (WP 0412). Open pump operator's panel housing (WP 0325). Disconnect pump house wire harness DRIVER SIDE PRE-CONNECT B valve control connector. Turn battery disconnect switch to ON position (WP 0007). Check for 22 to 28 VDC between pump operator's panel wire harness wire 4081 (blue) at DRIVER SIDE PRE-CONNECT B valve control connector, terminal A and a known good ground.

If 22 to 28 VDC are not present, go to Step 20

- Step 19. Turn battery disconnect switch to OFF position (WP 0007). With a test lead set, check for continuity across wire 3895 (black) from pump operator's panel DRIVER SIDE PRE-CONNECT B valve control connector, terminal B and a known good ground.
- If there is continuity, replace DRIVER SIDE PRE-CONNECT B valve control (WP 0417).
  - If there is no continuity, repair wire 3895 in pump operator's panel wire harness if repairable (TM 9-2320-325-14&P), or replace pump operator's panel wire harness (WP 0459).

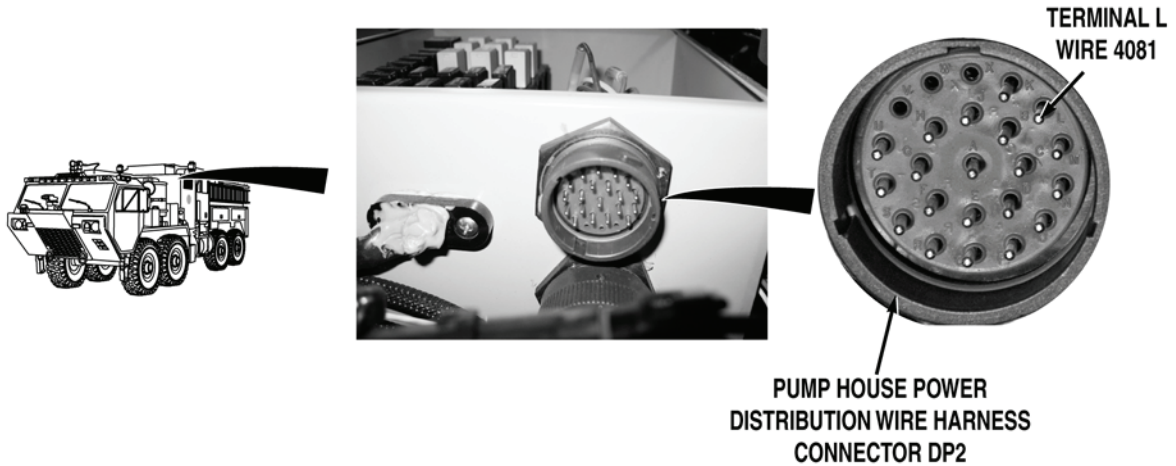
**MALFUNCTION****TEST OR INSPECTION****CORRECTIVE ACTION**

- Step 20. Turn battery disconnect switch to OFF position (WP 0007). Disconnect pump operator's panel wire harness pump house power distribution wire harness connector DP2. Turn battery disconnect switch to ON position (WP 0007). With a test lead set, check for 22 to 28 VDC between pump house power distribution wire harness wire 4081 (brown) at connector DP2, terminal L and a known good ground.
- a. If 22 to 28 VDC are present, repair wire 4081 in pump house wire harness if repairable (TM 9-2320-325-14&P), or replace pump operator's panel wire harness (WP 0459).
  - b. If 22 to 28 VDC are not present, repair wire 4081 in pump house power distribution wire harness if repairable (TM 9-2320-325-14&P), or replace pump house power distribution wire harness and block (WP 0457).

**END OF TASK****FOLLOW-ON MAINTENANCE**

Remove wheel chocks (TM 9-2320-347-10)

**END OF TASK****END OF WORK PACKAGE**



**FIELD LEVEL MAINTENANCE**

**NO. 1 DISCHARGE VALVE (DRIVER SIDE) DOES NOT OPERATE PROPERLY**

**INITIAL SETUP:**

**Tools and Special Tools**

Lead Set, Test (WP 0622, Item 21)  
 Tool Kit, General Mechanic's: Automotive  
 (WP 0622, Item 27)

**Personnel Required**

MOS 63B Wheeled vehicle mechanic (2)

**References**

TM 9-2320-325-14&P  
 WP 0004  
 WP 0007  
 WP 0325  
 WP 0387  
 WP 0388  
 WP 0390

**References (continued)**

WP 0411  
 WP 0412  
 WP 0417  
 WP 0451  
 WP 0453  
 WP 0457  
 WP 0459  
 WP 0460  
 WP 0485  
 WP 0539

**Equipment Conditions**

Water pump engine OFF (WP 0022)  
 Engine OFF (TM 9-2320-347-10)  
 Wheels chocked (TM 9-2320-347-10)

**MALFUNCTION**

**TEST OR INSPECTION**

**CORRECTIVE ACTION**

**NO. 1 DISCHARGE VALVE (DRIVER SIDE) DOES NOT OPERATE PROPERLY**

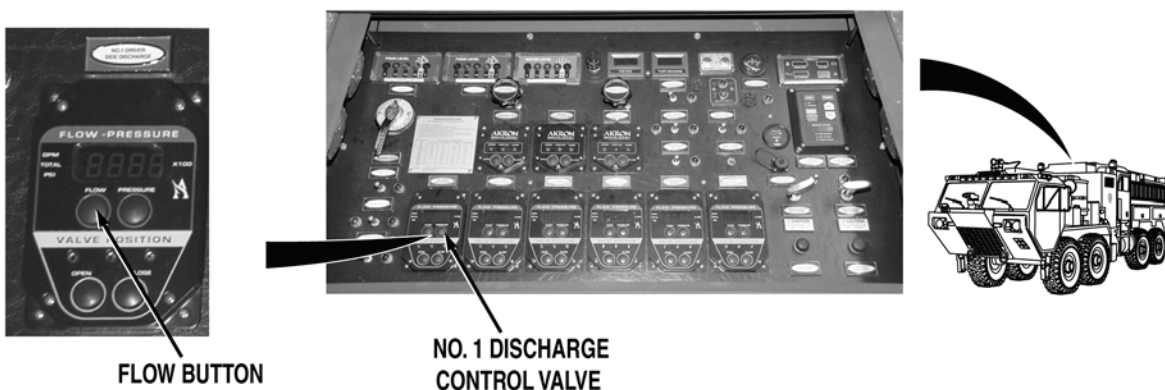

**NOTE**

Ensure batteries are fully charged before performing Step 1.

Step 1. Turn battery disconnect switch to ON position (WP 0007). Check if pump operator's panel NO. 1 DRIVER SIDE DISCHARGE valve control display illuminates.

If display is not illuminated, go to Step 17.

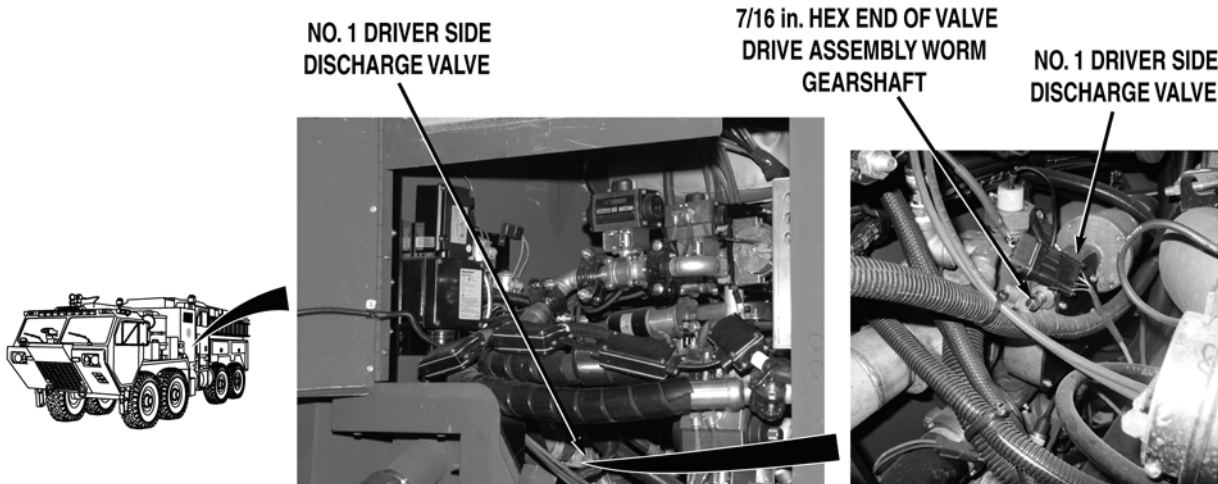
**MALFUNCTION****TEST OR INSPECTION****CORRECTIVE ACTION****NOTE**

- Valve operation can be checked by noting vibration of valve assembly, or by observing rotation of 7/16 in. hex at end of valve drive assembly worm gearshaft.
- Do not remove cap from NO. 1 DRIVER SIDE DISCHARGE. Water may be released from system when valve is operated.

Step 2. Open pump house panel A (WP 0539). While an assistant pushes pump operator's panel NO. 1 DRIVER SIDE DISCHARGE valve control OPEN and CLOSE buttons (WP 0004), check if No. 1 driver side discharge valve operates to open and close positions.

If No. 1 driver side discharge valve does not operate to open and close positions, go to Step 9.

Step 3. While an assistant monitors the operation of No. 1 driver side discharge valve. Push pump operator's panel NO. 1 DRIVER SIDE DISCHARGE valve control OPEN and CLOSE buttons (WP 0004). Check if NO. 1 DRIVER SIDE DISCHARGE valve control opened (green) and closed (red) indicators illuminate before No. 1 driver side discharge valve is fully open and closed.

If NO. 1 DRIVER SIDE DISCHARGE valve control indicators illuminate before No. 1 driver side discharge valve is fully opened or closed, go to Step 13.



**MALFUNCTION****TEST OR INSPECTION****CORRECTIVE ACTION****NOTE**

Valve operations must be checked by observing rotation of 7/16 in. hex at end of valve drive assembly worm gearshaft for Step 4

- Step 4. While an assistant pushes pump operator's panel NO. 1 DRIVER SIDE DISCHARGE valve control OPEN and CLOSE buttons (WP 0004), check if No. 1 driver side discharge valve worm gearshaft moves after valve is fully opened or closed.

If No. 1 driver side discharge valve worm gearshaft moves excessively after valve is fully open and closed, remove and reinstall No. 1 driver side discharge valve motor (WP 0388), ensuring all mounting hardware is secure.

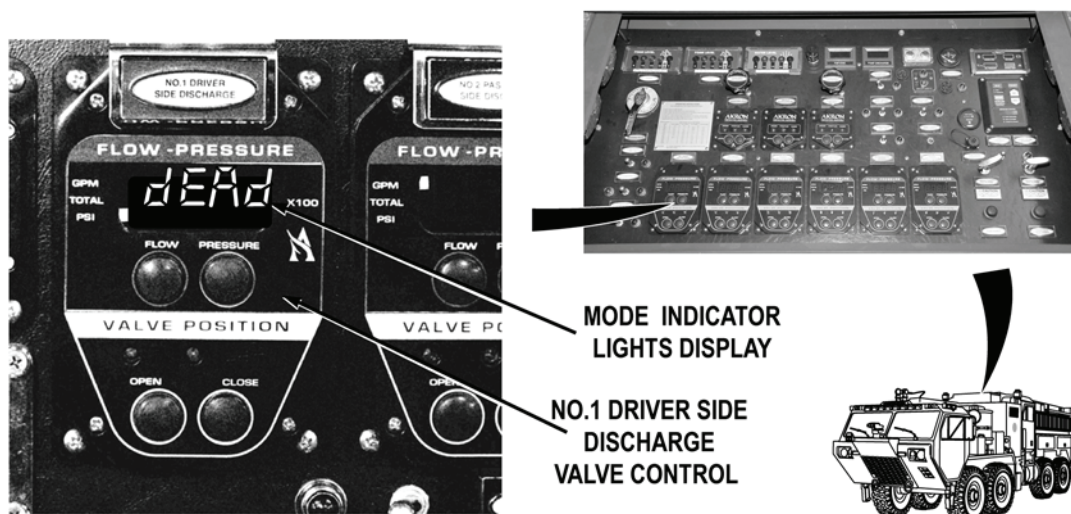

- Step 5. Push pump operator's panel NO. 1 DRIVER SIDE DISCHARGE valve control PRESSURE button. Check if dEAd error is in mode indicator lights display.

If dEAd error message is displayed, replace NO. 1 DRIVER SIDE DISCHARGE valve control (WP 0417).

**MALFUNCTION**

**TEST OR INSPECTION**

**CORRECTIVE ACTION**

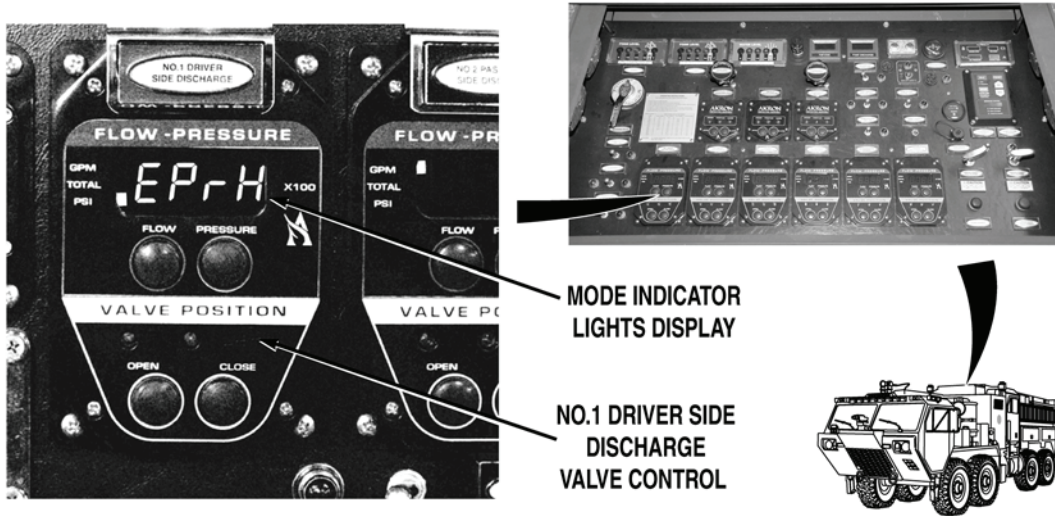

MODE INDICATOR LIGHTS DISPLAY

NO.1 DRIVER SIDE DISCHARGE VALVE CONTROL

Step 6. Check if EPrL or EPrH error is indicated in No. 1 DRIVER SIDE DISCHARGE mode indicator lights display.

If EPrL or EPrH error message is displayed, go to Step 15

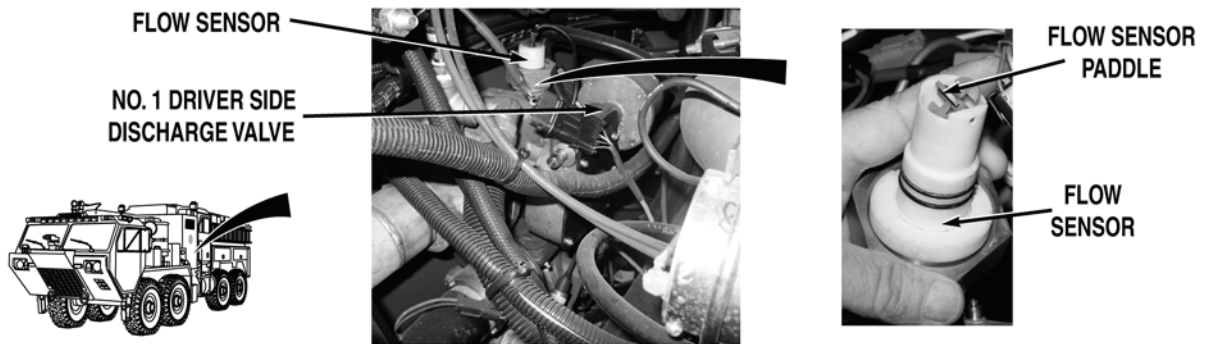
**MALFUNCTION****TEST OR INSPECTION****CORRECTIVE ACTION****WARNING**

**Remove rings, wristwatches, neck chains, and any other jewelry before working around vehicle. Jewelry can catch on equipment and cause serious injury. Jewelry and tools may short across electrical circuits and cause damage to equipment, or severe burns or electrical shock to personnel.**

- Step 7. Remove No. 1 driver side discharge valve flow sensor (WP 0390). Do not disconnect wires from sensor. Press pump operator's panel NO. 1 DRIVER SIDE DISCHARGE valve control FLOW button. While an assistant spins flow sensor paddle, check if a flow reading is displayed when flow sensor paddle is spinning.

If a reading of 0 gpm (0 lpm) is displayed when the flow sensor paddle is spinning, go to Step 16.

- Step 8. Install No. 1 driver side discharge valve flow sensor (WP 0390). Remove No. 1 driver side discharge valve (WP 0485) and inspect it for damage and contamination.
- a. If No. 1 driver side discharge valve is free from damage and contamination, reinstall valve (WP 0485) and go to Step 9.
  - b. If No. 1 driver side discharge valve is damaged and/or contaminated, repair (WP 0387) or replace No. 1 driver side discharge valve (WP 0485).

**MALFUNCTION****TEST OR INSPECTION****CORRECTIVE ACTION**

**NO. 1 DRIVER SIDE DISCHARGE  
VALVE CONTROL WIRE HARNESS**

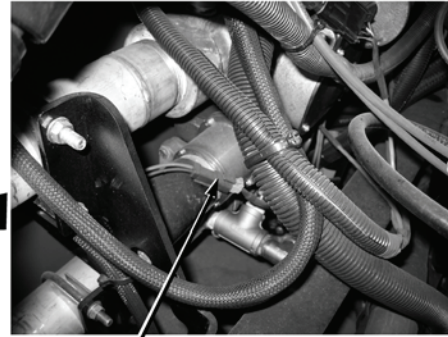

**NO. 1 DRIVER SIDE DISCHARGE  
VALVE CONTROL WIRE HARNESS  
AT VALVE MOTOR**

- Step 9. Open pump operator's panel housing (WP 0325). Check discharge valve control wire harness at NO. 1 DRIVER SIDE DISCHARGE valve control and No. 1 driver side discharge valve motor for loose connections.

If discharge valve control wire harness connectors are loose, reconnect loose connectors (WP 0453).

**NOTE**

- Engine may have to be running to provide enough power to operate valve control. Valve will operate with less voltage, but only yellow indicator light will register on valve control.
- Do not engage water pump engine during this procedure. Valve operations can be checked without water pump operation.
- Valve motor operation can be checked by noting vibration of valve assembly, or by observing rotation of 7/16 in. hex at end of valve drive assembly worm gearshaft.
- Do not remove cap from No. 1 driver side discharge. Water may be released from system when valve is operated.

- Step 10. While an assistant pushes pump operator's panel NO. 1 DRIVER SIDE DISCHARGE valve control OPEN and CLOSE buttons (WP 0004), check if NO. 1 DRIVER SIDE DISCHARGE valve control yellow indicator light illuminates and No. 1 driver side discharge valve motor operates.

If yellow indicator light illuminates and valve motor operates, replace No. 1 driver side discharge valve drive assembly (WP 0388).

**MALFUNCTION**  
**TEST OR INSPECTION**  
**CORRECTIVE ACTION**

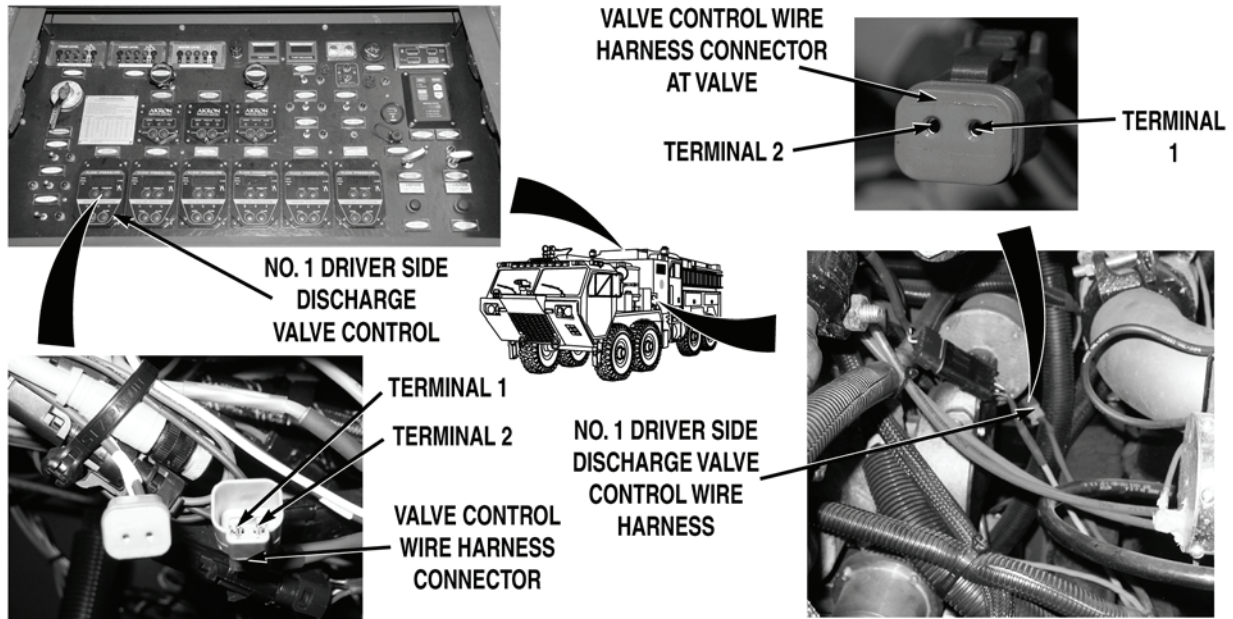

**WARNING**



**Remove rings, wristwatches, neck chains, and any other jewelry before working around vehicle. Jewelry can catch on equipment and cause serious injury. Jewelry and tools may short across electrical circuits and cause damage to equipment, or severe burns or electrical shock to personnel.**

- Step 11. Turn battery disconnect switch to OFF position (WP 0007). Disconnect valve control wire harness connectors from NO. 1 DRIVER SIDE DISCHARGE valve control. Disconnect valve control wire harness connector from No. 1 driver side discharge valve motor. With a test lead set, check for continuity across discharge valve control wire harness from terminal to terminal.

If there is no continuity, repair discharge valve control wire harness if repairable (TM 9-2320-325-14&P), or replace No. 1 driver side discharge valve control wire harness (WP 0453).

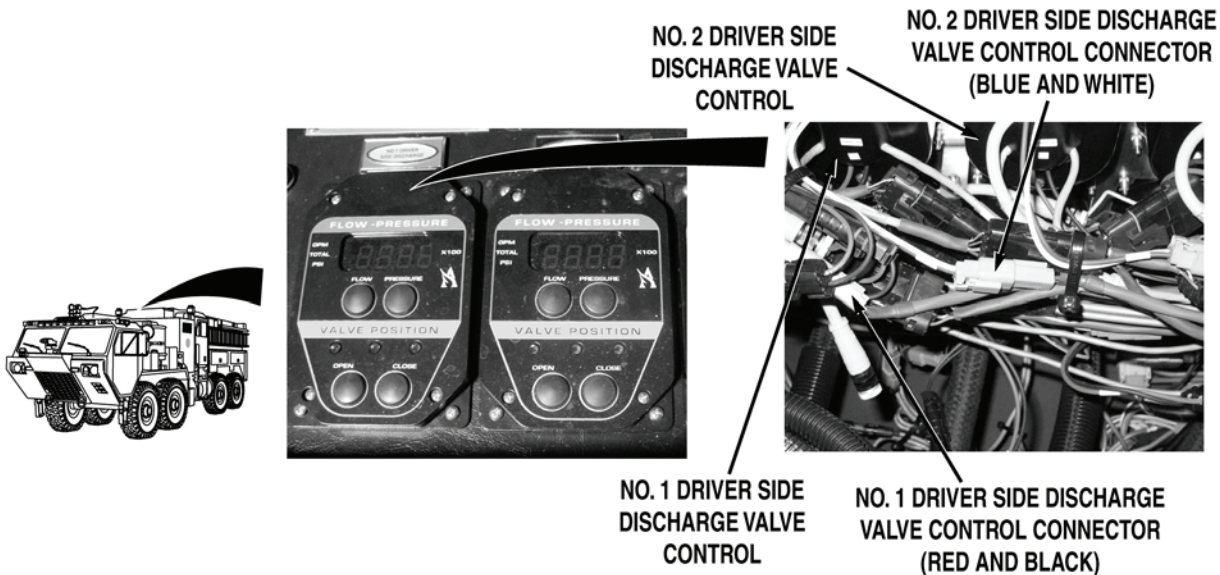
**MALFUNCTION****TEST OR INSPECTION****CORRECTIVE ACTION**

- Step 12. Connect valve control wire harness connector to No. 1 driver side discharge valve motor. Disconnect valve control wire harness connector from NO. 2 DRIVER SIDE DISCHARGE VALVE CONTROL. Connect No. 1 driver side discharge valve control wire harness connector to NO. 2 DRIVER SIDE DISCHARGE VALVE CONTROL. Turn the battery disconnect switch to ON position (WP 0007). While an assistant pushes pump operator's panel No. 2 Driver Side Discharge valve control OPEN and CLOSE buttons (WP 0004), check if No. 1 driver side discharge valve operates.
- a. If No. 1 driver side discharge valve operates, reconnect valve control wire harness connectors to original positions and replace NO. 1 DRIVER SIDE DISCHARGE valve control (WP 0417).
  - b. If No. 1 driver side discharge valve does not operate, reconnect valve control wire harness connectors to original positions and replace No. 1 driver side discharge valve motor (WP 0388).

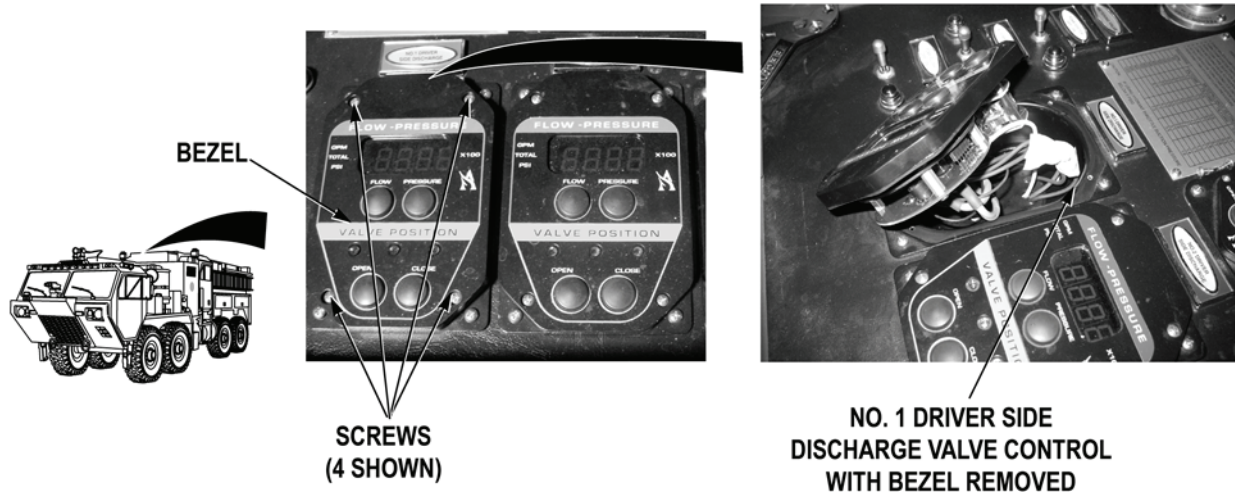
**MALFUNCTION****TEST OR INSPECTION****CORRECTIVE ACTION**

- Step 13. Remove 4 screws and bezel from pump operator's panel NO. 1 DRIVER SIDE DISCHARGE valve control. Check for signs of water and moisture damage.

If valve control shows evidence of water and moisture damage, replace NO. 1 DRIVER SIDE DISCHARGE valve control (WP 0417).

- Step 14. Install 4 screws and bezel on NO. 1 DRIVER SIDE DISCHARGE valve control. Remove No. 1 driver side discharge valve (WP 0485) and inspect it for binding, damage, and contamination.
- a. If No. 1 driver side discharge valve is free from binding, damage, and contamination, reinstall valve (WP 0485) and replace No. 1 driver side discharge valve motor and drive assembly (WP 0388).
  - b. If No. 1 driver side discharge valve is not free from binding, damage, and contamination, repair (WP 0387) or replace No. 1 driver side discharge valve (WP 0485).

## MALFUNCTION

## TEST OR INSPECTION

## CORRECTIVE ACTION



NO. 1 DRIVER SIDE  
DISCHARGE VALVE CONTROL

PRESSURE  
TRANSDUCER WITH  
WIRE HARNESS REMOVED,  
DIRECT CONNECTION  
TO NO. 1 DRIVER SIDE  
DISCHARGE VALVE  
CONTROL

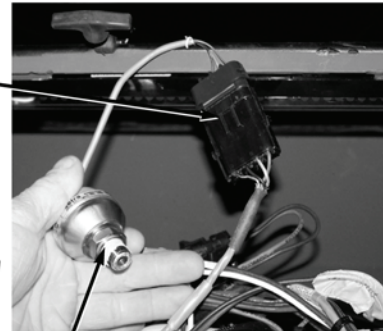

PRESSURE  
TRANSDUCER

**WARNING**

Remove rings, wristwatches, neck chains, and any other jewelry before working around vehicle. Jewelry can catch on equipment and cause serious injury. Jewelry and tools may short across electrical circuits and cause damage to equipment, or severe burns or electrical shock to personnel.

- Step 15. Open pump house panel A (WP 0539). Open pump operator's panel housing (WP 0325). Remove No. 1 driver side discharge valve pressure transducer (WP 0411). Connect pressure transducer to NO. 1 DRIVER SIDE DISCHARGE valve control (removing pressure transducer wire harness from circuit). Check if error message EPrL or EPrH is displayed.
- a. If EPrL or EPrH error message is displayed, replace No. 1 driver side discharge valve pressure transducer (WP 0411).
  - b. If EPrL or EPrH error message is not displayed, repair pressure transducer wire harness if repairable (TM 9-2320-325-14&P), or replace No. 1 driver side discharge pressure transducer wire harness (WP 0460).

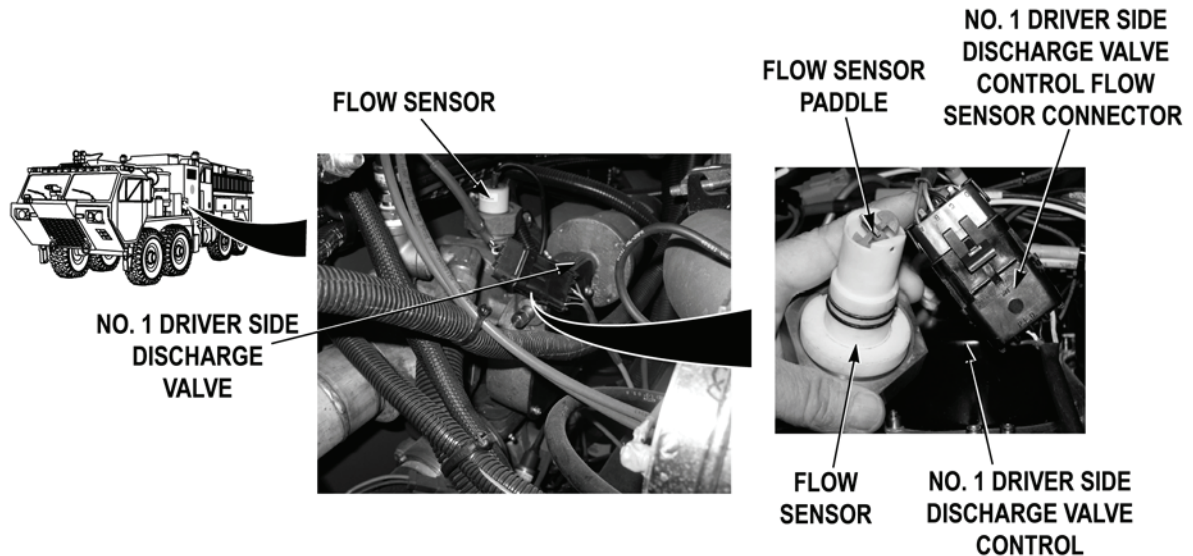

**MALFUNCTION****TEST OR INSPECTION****CORRECTIVE ACTION**

- Step 16. Disconnect No. 1 driver side discharge flow sensor (WP 0390) and connect it directly to NO. 1 DRIVER SIDE DISCHARGE valve control (removing flow sensor wire harness from circuit). While an assistant spins flow sensor paddle wheel, check if a flow reading is displayed when the flow sensor paddle is spinning.
- a. If a flow reading is displayed when flow sensor paddle is spinning, repair flow sensor wire harness if repairable (TM 9-2320-325-14&P), or replace No. 1 driver side discharge flow sensor wire harness (WP 0451).
  - b. If a flow reading is not displayed when flow sensor paddle is spinning, replace No. 1 driver side discharge flow sensor (WP 0390).

## MALFUNCTION

## TEST OR INSPECTION

## CORRECTIVE ACTION

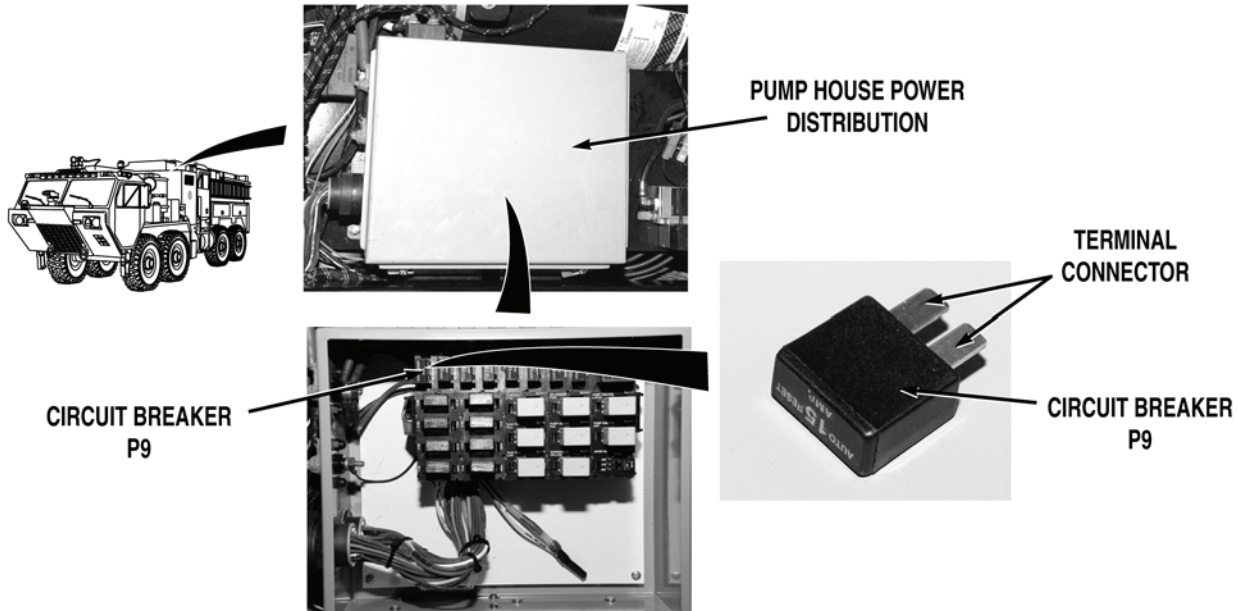
**WARNING**

Remove rings, wristwatches, neck chains, and any other jewelry before working around vehicle. Jewelry can catch on equipment and cause serious injury. Jewelry and tools may short across electrical circuits and cause damage to equipment, or severe burns or electrical shock to personnel.

- Step 17. Turn battery disconnect switch to OFF position (WP 0007). Remove pump house panel S (WP 0540). Open pump house power distribution (WP 0412). Remove circuit breaker P9 (WP 0412). Check for continuity across circuit breaker.

If there is no continuity, replace circuit breaker P9 (WP 0412).

**MALFUNCTION**  
**TEST OR INSPECTION**  
**CORRECTIVE ACTION**



**PUMP OPERATOR'S PANEL  
 WIRE HARNESS NO. 1 DRIVER SIDE  
 DISCHARGE VALVE CONTROL CONNECTOR**

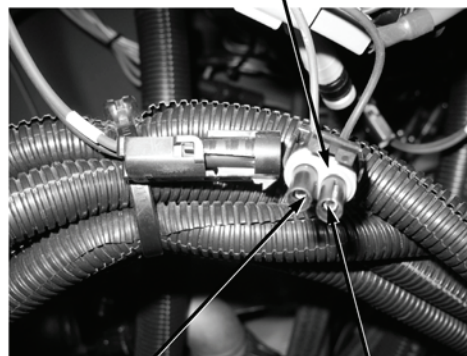

**TERMINAL A  
 WIRE 4076**

**TERMINAL B  
 WIRE 3895**

**WARNING**



**Remove rings, wristwatches, neck chains, and any other jewelry before working around vehicle. Jewelry can catch on equipment and cause serious injury. Jewelry and tools may short across electrical circuits and cause damage to equipment, or severe burns or electrical shock to personnel.**

- Step 18. Install circuit breaker P9 (WP 0412). Open pump operator's panel housing (WP 0325). Disconnect pump house wire harness NO. 1 DRIVER SIDE DISCHARGE valve control connector. Turn battery disconnect switch to ON position (WP 0007). With a test lead set, check for 22 to 28 VDC between pump operator's panel wire harness wire 4076 (purple) at NO. 1 DRIVER SIDE DISCHARGE valve control connector, terminal A and a known good ground.

If 22 to 28 VDC are not present, go to Step 20.

- Step 19. Turn battery disconnect switch to OFF position (WP 0007). With a test lead set, check for continuity across wire 3895 (black) from pump operator's panel NO. 1 DRIVER SIDE DISCHARGE valve control connector, terminal B and a known good ground.
- a. If there is continuity, replace NO. 1 DRIVER SIDE DISCHARGE valve control (WP 0417).
  - b. If there is no continuity, repair wire 3895 in pump operator's panel wire harness if repairable (TM 9-2320-325-14&P), or replace pump operator's panel wire harness (WP 0459).

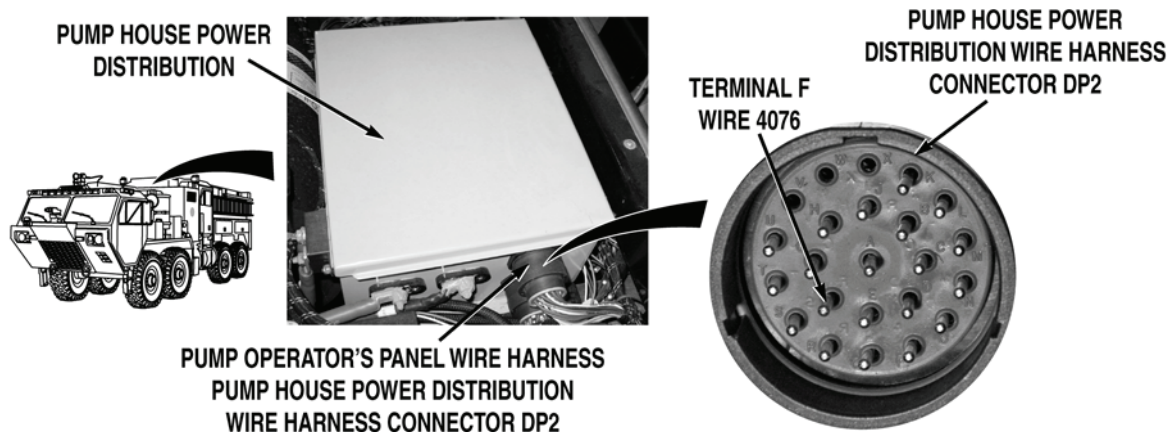
**MALFUNCTION****TEST OR INSPECTION****CORRECTIVE ACTION****WARNING**

Remove rings, wristwatches, neck chains, and any other jewelry before working around vehicle. Jewelry can catch on equipment and cause serious injury. Jewelry and tools may short across electrical circuits and cause damage to equipment, or severe burns or electrical shock to personnel.

- Step 20. Turn battery disconnect switch to OFF position (WP 0007). Disconnect pump operator's panel wire harness pump house power distribution wire harness connector DP2. Turn battery disconnect switch to ON position (WP 0007). With a test lead set, check for 22 to 28 VDC between pump house power distribution wire harness wire 4076 (purple) at connector DP2, terminal F and a known good ground.
- a. If 22 to 28 VDC are present, repair wire 4076 in pump operator's panel wire harness if repairable (TM 9-2320-325-14&P), or replace pump operator's panel wire harness (WP 0459).
  - b. If 22 to 28 VDC are not present, repair wire 4076 in pump house power distribution wire harness if repairable (TM 9-2320-325-14&P), or replace pump house power distribution wire harness and block (WP 0457).

**END OF TASK****FOLLOW-ON MAINTENANCE**

Remove wheel chocks

**END OF TASK****END OF WORK PACKAGE**

**FIELD LEVEL MAINTENANCE**

**NO. 2 DISCHARGE VALVE (DRIVER SIDE) DOES NOT OPERATE PROPERLY**

**INITIAL SETUP:**

**Tools and Special Tools**

- Lead Set, Test (WP 0622, Item 21)
- Tool Kit, General Mechanic's: Automotive (WP 0622, Item 27)

**Personnel Required**

- MOS 63B Wheeled vehicle mechanic (2)

**References**

- TM 9-2320-325-14&P
- WP 0004
- WP 0007
- WP 0326
- WP 0387
- WP 0388
- WP 0390

**References (continued)**

- WP 0411
- WP 0412
- WP 0417
- WP 0451
- WP 0453
- WP 0457
- WP 0459
- WP 0460
- WP 0486
- WP 0539
- WP 0540

**Equipment Conditions**

- Water pump engine OFF (WP 0022)
- Engine OFF (TM 9-2320-347-10)
- Wheels chocked (TM 9-2320-347-10)

**MALFUNCTION**

**TEST OR INSPECTION**

**CORRECTIVE ACTION**

**NO. 2 DISCHARGE VALVE (DRIVER SIDE) DOES NOT OPERATE PROPERLY**

**MALFUNCTION**

**TEST OR INSPECTION**

**CORRECTIVE ACTION**

MODE INDICATOR LIGHTS NO. 2 DRIVER SIDE DISCHARGE VALVE CONTROL

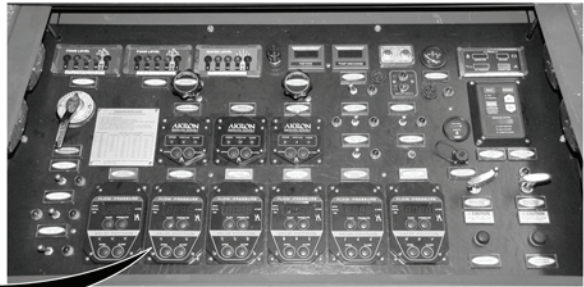
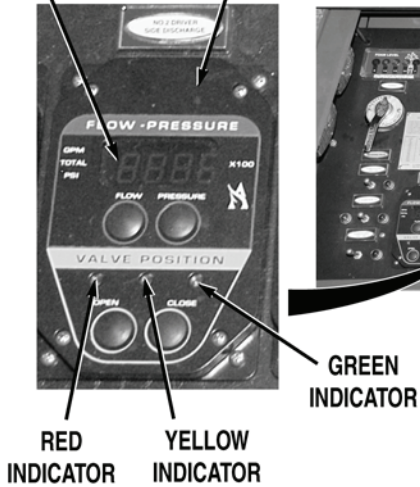

**NOTE**

Ensure batteries are fully charged before performing Step 1.

Step 1. Turn battery disconnect switch to ON position (WP 0007). Check if pump operator's panel NO. 2 DRIVER SIDE DISCHARGE valve control display illuminates.

If display is not illuminated, go to Step 17.

---

<b>MALFUNCTION</b>	<b>TEST OR INSPECTION</b>	<b>CORRECTIVE ACTION</b>
--------------------	---------------------------	--------------------------

---

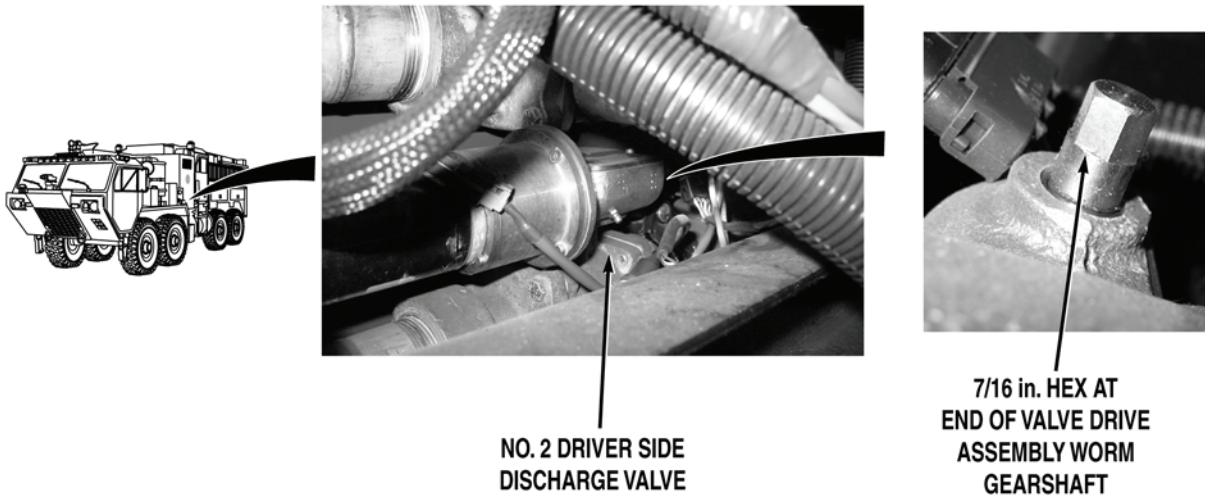
**NOTE**

- Valve operation can be checked by noting vibration of valve assembly or by observing rotation of 7/16 in. hex at end of valve drive assembly worm gearshaft.
- Do not remove cap from NO. 2 DRIVER SIDE DISCHARGE. Water may be released from system when valve is operated.

Step 2. Open pump house panel A (WP 0539). While an assistant pushes pump operator's panel NO. 2 DRIVER SIDE DISCHARGE valve control OPEN and CLOSE buttons (WP 0004), check if No. 2 driver side discharge valve operates to open and close positions.

If No. 2 driver side discharge valve does not open and close, go to Step 9.

**MALFUNCTION**

**TEST OR INSPECTION**

**CORRECTIVE ACTION**

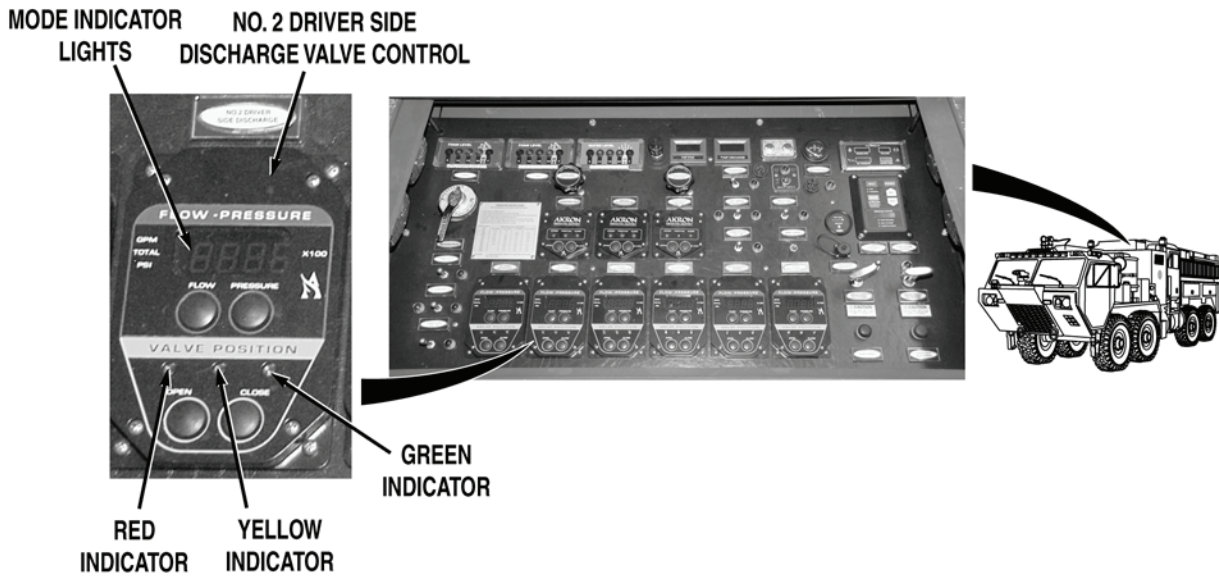

Step 3. While an assistant monitors operation of No. 2 driver side discharge valve, push pump operator's panel NO. 2 DRIVER SIDE DISCHARGE valve control OPEN and CLOSE buttons (WP 0004). Check if NO. 2 DRIVER SIDE DISCHARGE valve control open (green) and close (red) indicators illuminate before No. 2 driver side discharge valve is fully opened or closed.

If NO. 2 DRIVER SIDE DISCHARGE valve control indicators illuminate before No. 2 driver side discharge valve is fully opened or closed, go to Step 13



---

**MALFUNCTION**  
**TEST OR INSPECTION**  
**CORRECTIVE ACTION**

---

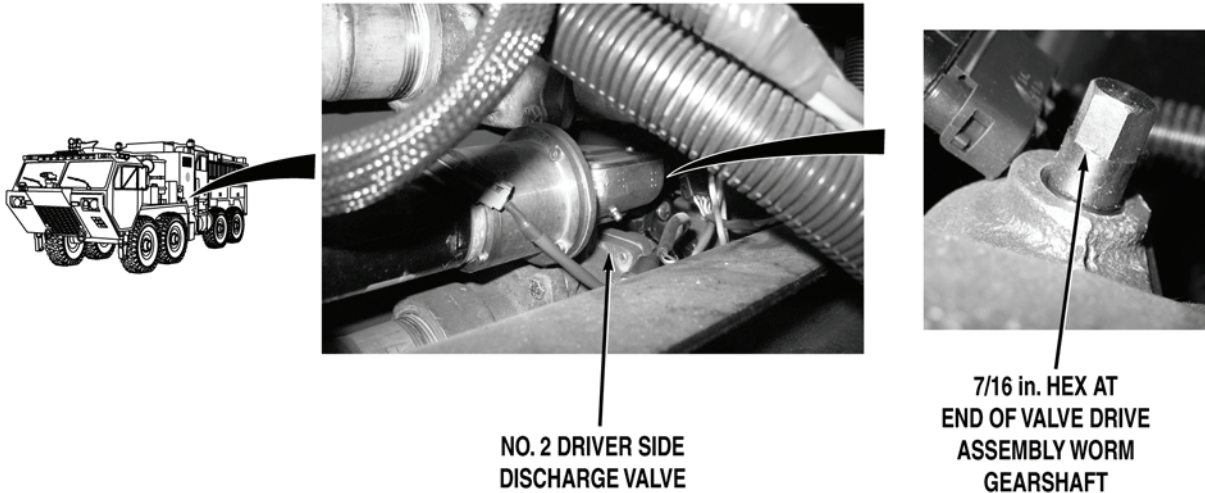

**NOTE**

Valve operation must be checked by observing rotation of 7/16 in. hex at end of valve drive assembly worm gearshaft for Step 4.

- Step 4. While an assistant pushes pump operator's panel NO. 2 DRIVER SIDE DISCHARGE valve control OPEN and CLOSE (WP 0004), check if No. 2 driver side discharge valve worm gearshaft moves excessively after valve is fully opened or closed.

If No. 2 driver side discharge valve worm gearshaft moves excessively after valve is fully opened or closed, remove and re-install No. 2 driver side discharge valve motor (WP 0388), ensuring all mounting hardware is secure.

**MALFUNCTION**

**TEST OR INSPECTION**

**CORRECTIVE ACTION**

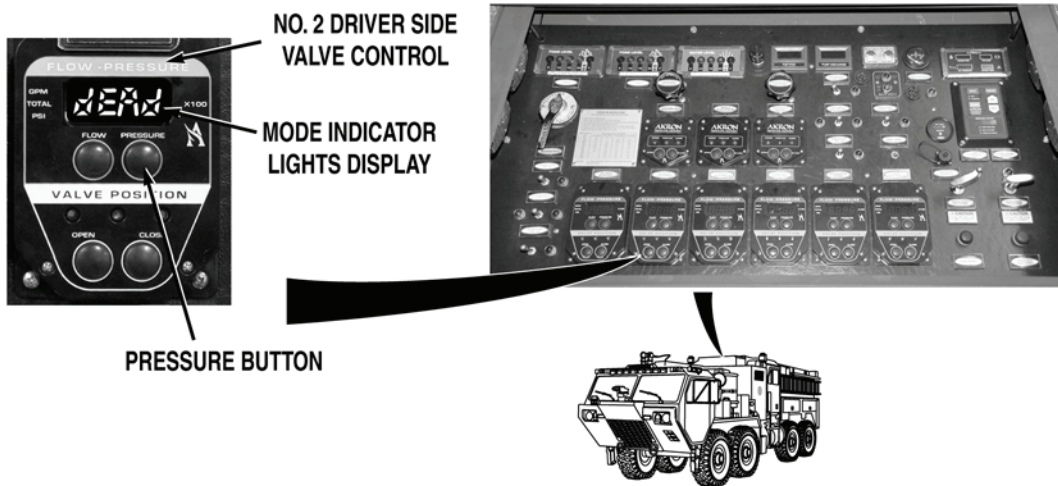

Step 5. Push pump operator's panel NO. 2 DRIVER SIDE DISCHARGE valve control PRESSURE button. Check if dEAd error is indicated in mode indicator lights display.

If dEAd error message is displayed, replace NO. 2 DRIVER SIDE DISCHARGE valve control (WP 0417).

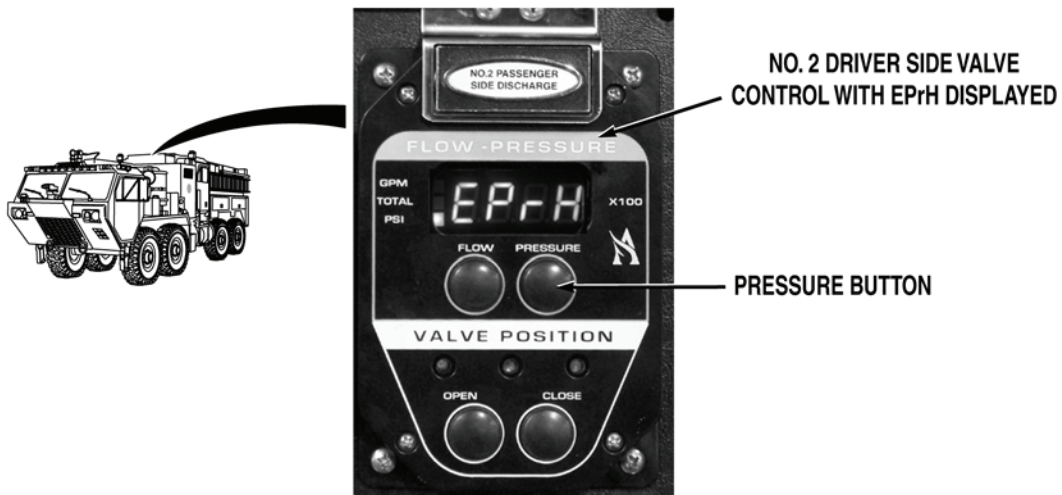

Step 6. Check if EPrL or EPrH error is indicated in mode indicator lights display.

If EPrL or EPrH error message is displayed, go to Step 15.

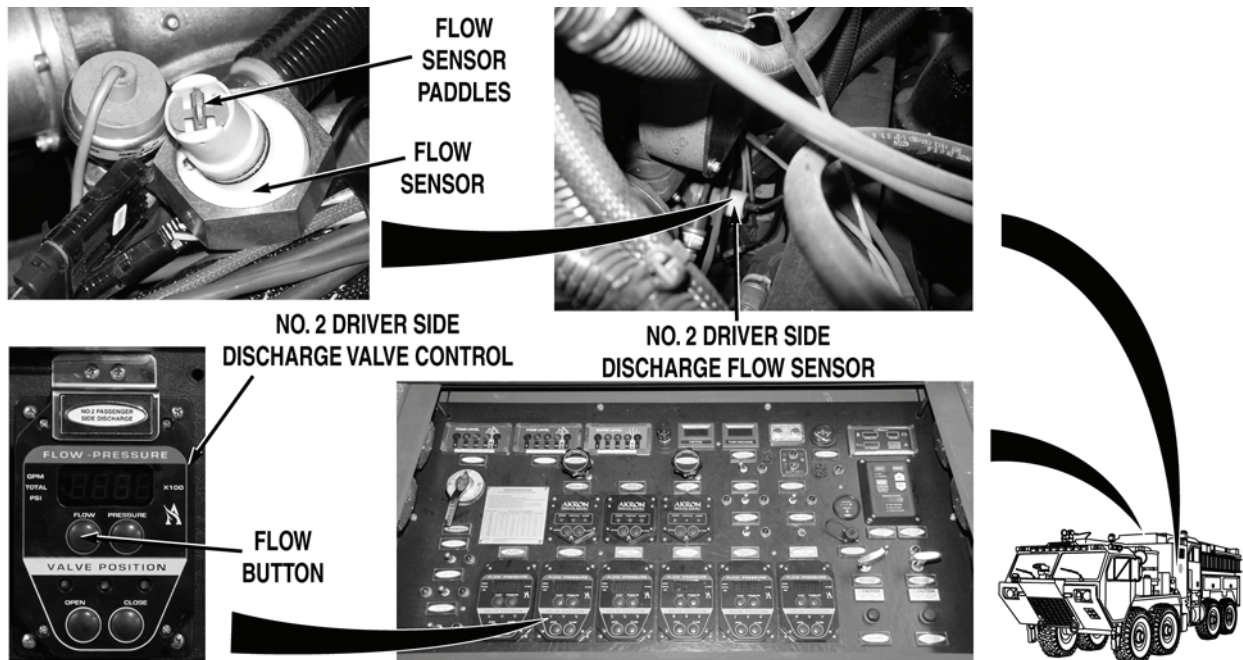
**MALFUNCTION****TEST OR INSPECTION****CORRECTIVE ACTION****WARNING**

**Remove rings, wristwatches, neck chains, and any other jewelry before working around vehicle. Jewelry can catch on equipment and cause serious injury. Jewelry and tools may short across electrical circuits and cause damage to equipment, or severe burns or electrical shock to personnel.**

- Step 7. Remove No. 2 driver side discharge valve flow sensor (WP 0390). Do not disconnect wires from sensor. Push pump operator's panel NO. 2 DRIVER SIDE DISCHARGE valve control FLOW button. While an assistant spins flow sensor paddle, check if a flow reading is displayed when flow sensor paddle is spinning.

If a reading of 0 gpm (0 lpm) is displayed when flow sensor paddle is spinning, go to Step 16.

- Step 8. Install No. 2 driver side discharge valve flow sensor (WP 0390). Remove No. 2 driver side discharge valve (WP 0486) and inspect it for damage and contamination.
- a. If No. 2 driver side discharge valve is free from damage and contamination, reinstall valve (WP 0486) and go to Step 9.
  - b. If No. 2 driver side discharge valve is damaged and/or contaminated, repair (WP 0387) or replace No. 2 driver side discharge valve (WP 0486).

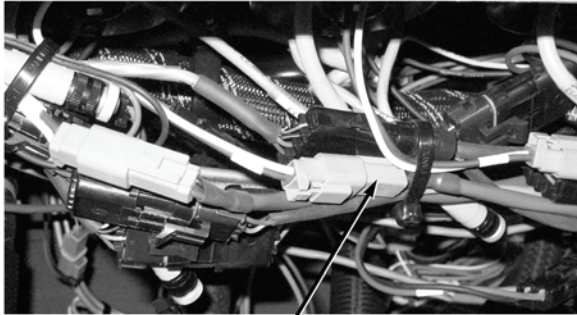
**MALFUNCTION****TEST OR INSPECTION****CORRECTIVE ACTION**

**NO. 2 DRIVER SIDE  
DISCHARGE VALVE CONTROL  
WIRE HARNESS CONNECTOR**

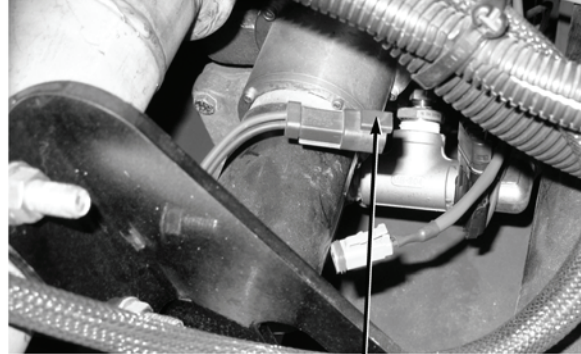

**NO. 2 DRIVER SIDE  
DISCHARGE VALVE CONTROL  
WIRE HARNESS CONNECTOR**



- Step 9. Open pump operator's panel housing (WP 0325). Check No. 2 driver side discharge valve control wire harness at NO. 2 DRIVER SIDE DISCHARGE valve control and No. 2 driver side discharge valve motor for loose connections.

If No. 2 driver side discharge valve control wire harness connectors are loose, reconnect loose connectors (WP 0453).

**NOTE**

- Engine may have to be running to provide enough power to operate valve control. Valve will operate with less voltage, but only yellow indicator light will register on valve control.
- Do not engage water pump engine during this procedure. Valve operations can be checked without water pump operation.
- Valve motor operation can be checked by noting vibration of valve assembly, or by observing rotation of 7/16 in. hex at end of valve drive assembly worm gearshaft.
- Do not remove cap from NO. 2 DRIVER SIDE DISCHARGE. Water may be released from system when valve is operated.

- Step 10. While an assistant pushes pump operator's panel NO. 2 DRIVER SIDE DISCHARGE valve control OPEN and CLOSE buttons (WP 0004), check if NO. 2 DRIVER SIDE DISCHARGE valve control yellow indicator illuminates and No. 2 driver side discharge valve motor operates.

If indicator illuminates and valve motor operates, replace No. 2 driver side discharge valve drive assembly (WP 0388).

**MALFUNCTION**

**TEST OR INSPECTION**

**CORRECTIVE ACTION**

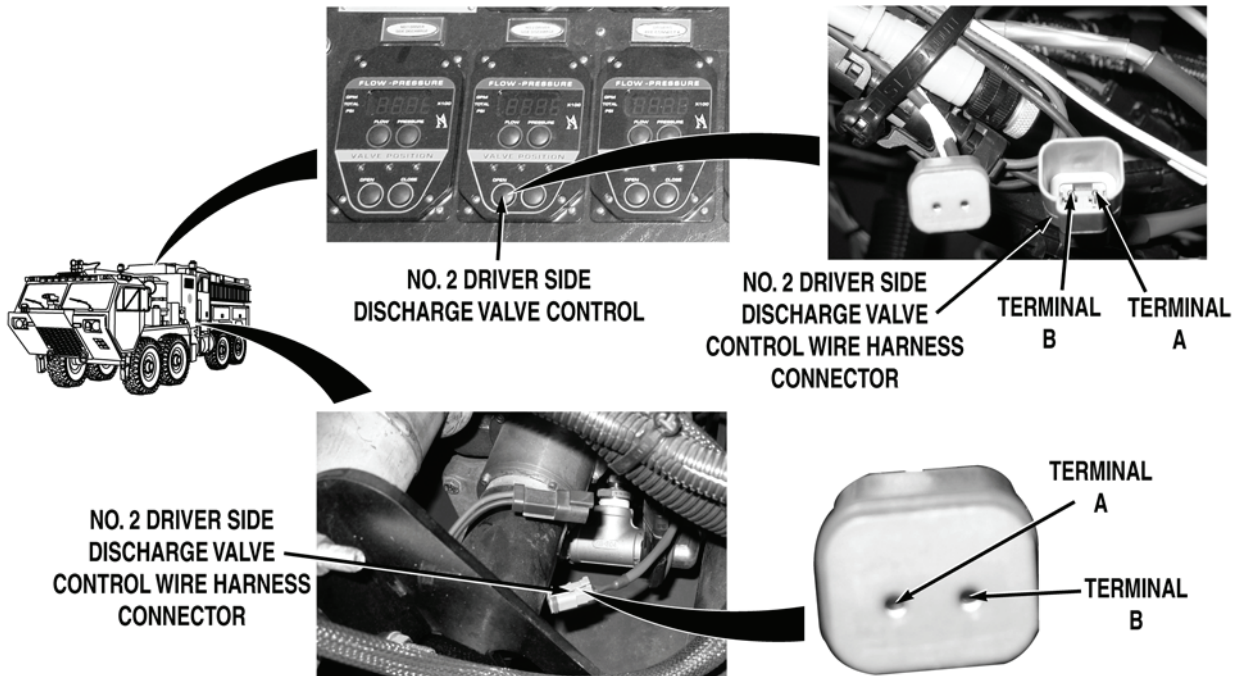

**WARNING**



Remove rings, wristwatches, neck chains, and any other jewelry before working around vehicle. Jewelry can catch on equipment and cause serious injury. Jewelry and tools may short across electrical circuits and cause damage to equipment, or severe burns or electrical shock to personnel.

- Step 11. Turn battery disconnect switch to OFF position (WP 0007). Disconnect No. 2 driver side discharge valve control wire harness connector from NO. 2 DRIVER SIDE DISCHARGE valve control. Disconnect No. 2 driver side discharge valve control wire harness connector from No. 2 driver side discharge valve motor. With a test lead set, check for continuity across discharge valve control wire harness from terminal to terminal.

If there is no continuity, repair No. 2 driver side discharge valve control wire harness if repairable (TM 9-2320-325-14&P), or replace No. 2 driver side discharge valve control wire harness (WP 0453).

## MALFUNCTION

## TEST OR INSPECTION

## CORRECTIVE ACTION

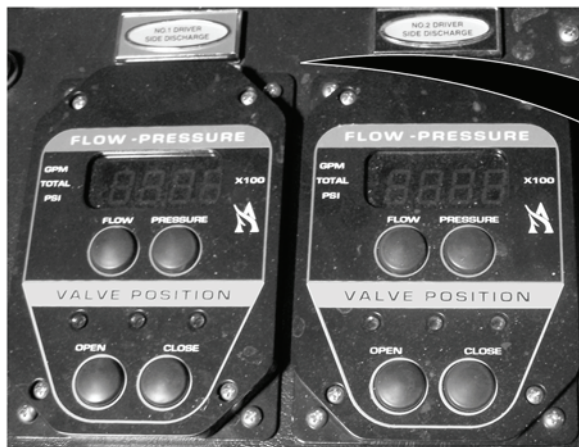
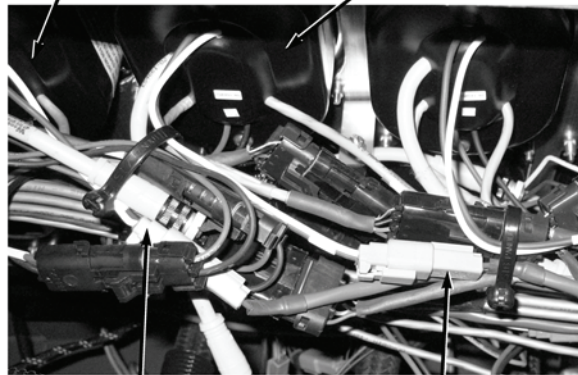
NO. 1 DRIVER SIDE  
DISCHARGE VALVE CONTROLNO. 2 DRIVER SIDE  
DISCHARGE VALVE CONTROLNO. 1 DRIVER SIDE  
DISCHARGE VALVE  
CONTROL CONNECTOR  
(BLUE AND WHITE)NO. 2 DRIVER SIDE  
DISCHARGE VALVE CONTROL  
WIRE HARNESS  
(RED AND BLACK)

- Step 12. Connect No. 2 driver side discharge valve control wire harness connector to No. 2 driver side discharge valve motor. Disconnect No. 1 driver side discharge valve control wire harness connector from NO. 1 DRIVER SIDE DISCHARGE valve control. Connect No. 2 driver side discharge valve control wire harness connector to NO. 1 DRIVER SIDE DISCHARGE valve control. Turn battery disconnect switch to ON position (WP 0007). While an assistant pushes pump operator's panel NO. 1 DRIVER SIDE DISCHARGE valve control OPEN and CLOSE buttons (WP 0004), check if No. 2 driver side discharge valve operates.
- a. If No. 2 driver side discharge valve operates, reconnect valve control wire harness connectors to original positions and replace NO. 2 DRIVER SIDE DISCHARGE valve control (WP 0417).
  - b. If No. 2 driver side discharge valve does not operate, reconnect valve control wire harness connectors to original positions and replace No. 2 driver side discharge valve motor (WP 0388).

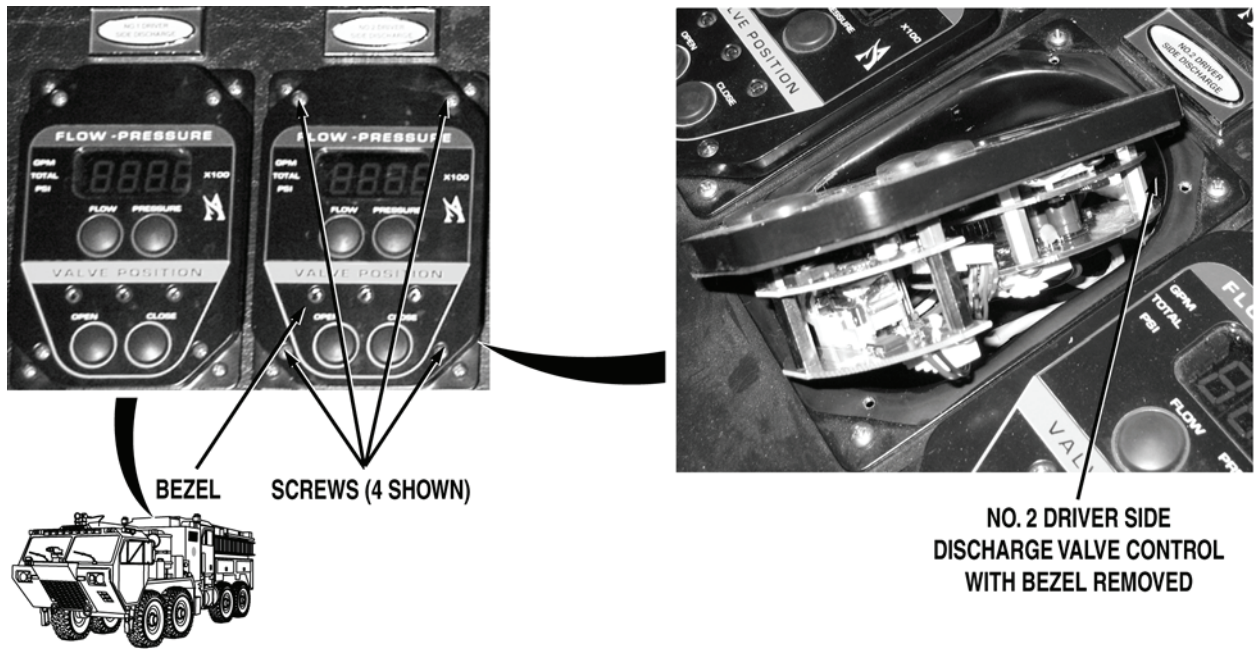
**MALFUNCTION****TEST OR INSPECTION****CORRECTIVE ACTION**

- Step 13. Remove four screws and bezel from pump operator's panel NO. 2 DRIVER SIDE DISCHARGE valve control. Check for signs of water and moisture damage.

If NO. 2 DRIVER SIDE DISCHARGE valve control shows evidence of water and moisture damage, replace NO. 2 DRIVER SIDE DISCHARGE valve control (WP 0417).

- Step 14. Install bezel and four screws on NO. 2 DRIVER SIDE DISCHARGE valve control. Remove No. 2 driver side discharge valve (WP 0486) and inspect it for binding, damage, and contamination.
- a. If No. 2 driver side discharge valve is free from binding, damage, and contamination, reinstall valve (WP 0486) and replace No. 2 driver side discharge valve motor and drive assembly (WP 0388).
  - b. If No. 2 driver side discharge valve is binding, damaged, and/or contaminated, repair (WP 0387) or replace No. 2 driver side discharge valve (WP 0486).

## MALFUNCTION

## TEST OR INSPECTION

## CORRECTIVE ACTION

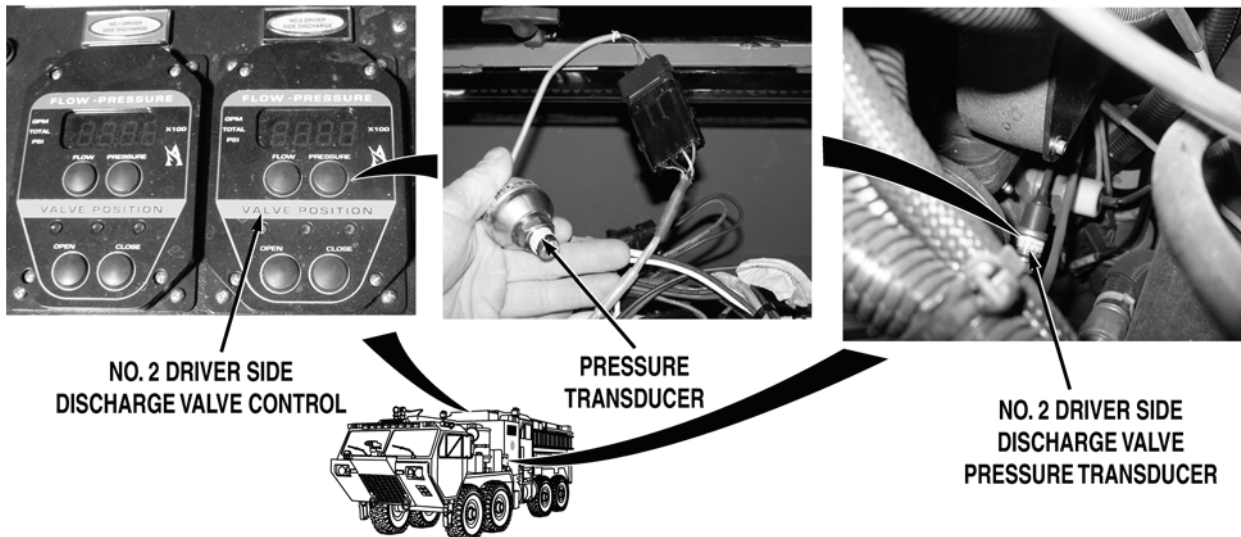
**WARNING**

Remove rings, wristwatches, neck chains, and any other jewelry before working around vehicle. Jewelry can catch on equipment and cause serious injury. Jewelry and tools may short across electrical circuits and cause damage to equipment, or severe burns or electrical shock to personnel.

- Step 15. Remove No. 2 driver side discharge valve pressure transducer (WP 0411). Disconnect No. 2 driver side discharge valve pressure transducer wire harness from NO. 2 DRIVER SIDE DISCHARGE valve control. Connect pressure transducer to NO. 2 DRIVER DISCHARGE valve control (removing wire harness from circuit). Check if error message EPrL or EPrH is displayed.
- a. If EPrL or EPrH error message is displayed, replace No. 2 driver side valve discharge pressure transducer (WP 0411).
  - b. If EPrL or EPrH error message is not displayed, repair pressure transducer wire harness if repairable (TM 9-2320-325-14&P), or replace No. 2 driver side discharge valve pressure transducer wire harness (WP 0460).

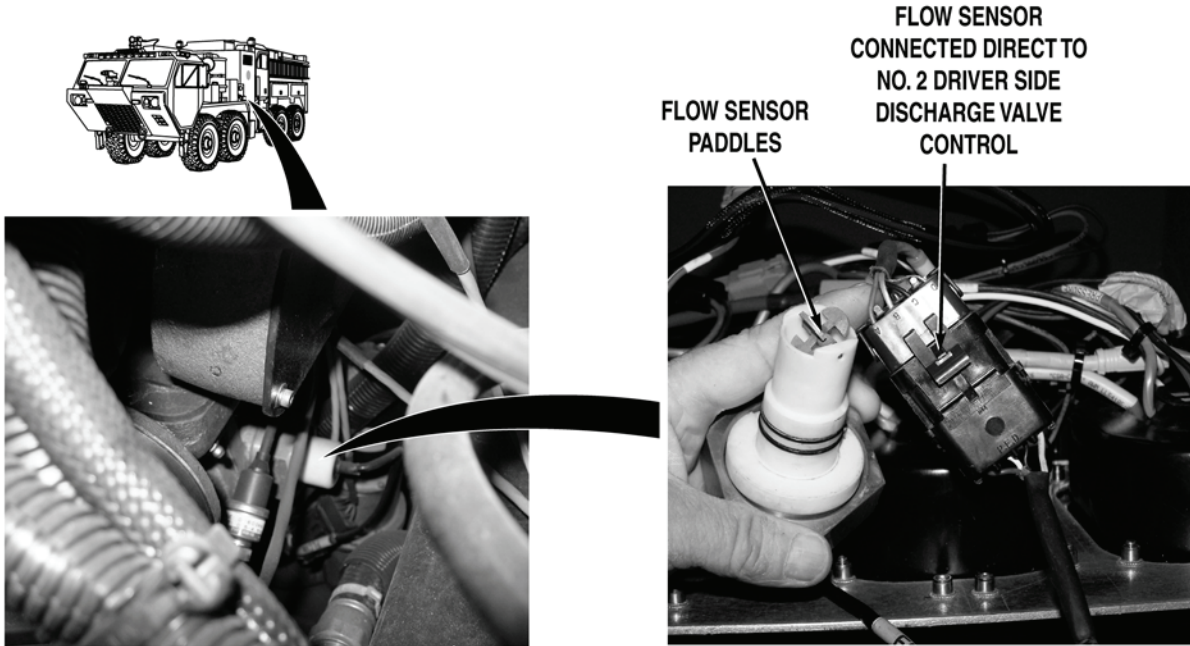

**MALFUNCTION****TEST OR INSPECTION****CORRECTIVE ACTION****WARNING**

**Remove rings, wristwatches, neck chains, and any other jewelry before working around vehicle. Jewelry can catch on equipment and cause serious injury. Jewelry and tools may short across electrical circuits and cause damage to equipment, or severe burns or electrical shock to personnel.**

- Step 16. Disconnect No. 2 driver side discharge valve flow sensor wire harness from No. 2 driver side discharge flow sensor. Disconnect No. 2 driver side discharge valve flow sensor wire harness from NO. 2 DRIVER DISCHARGE valve control. Connect No. 2 driver side discharge flow sensor to NO. 2 DRIVER DISCHARGE valve control (removing wire harness from circuit). While an assistant spins flow sensor paddle wheel, check if a flow reading is displayed when flow sensor paddle is spinning.
- a. If a flow reading is displayed when flow sensor paddle is spinning, repair flow sensor wire harness if repairable (TM 9-2320-325-14&P), or replace No. 2 driver side discharge valve flow sensor wire harness (WP 0451).
  - b. If a flow reading is not displayed when flow sensor paddle is spinning, replace No. 2 driver side discharge valve flow sensor (WP 0390).

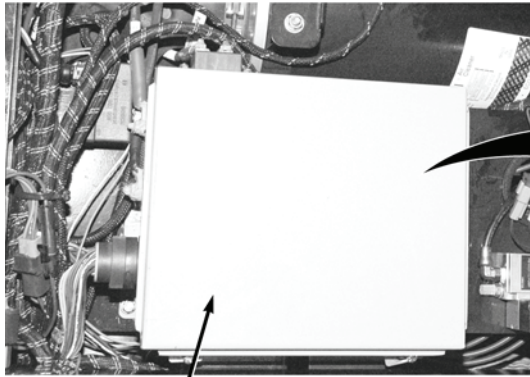
**MALFUNCTION****TEST OR INSPECTION****CORRECTIVE ACTION**

PUMP HOUSE  
POWER  
DISTRIBUTION BOX

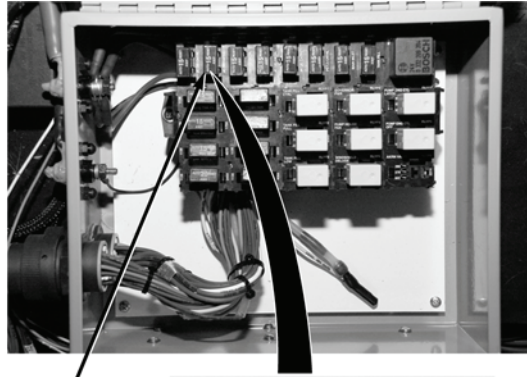

CIRCUIT BREAKER  
P10

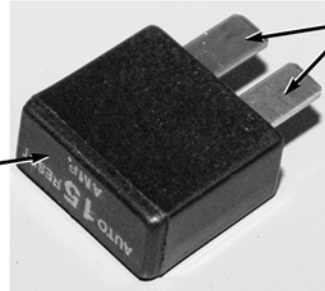

CIRCUIT  
BREAKER  
P10

TERMINAL  
CONNECTOR

**WARNING**

Remove rings, wristwatches, neck chains, and any other jewelry before working around vehicle. Jewelry can catch on equipment and cause serious injury. Jewelry and tools may short across electrical circuits and cause damage to equipment, or severe burns or electrical shock to personnel.

- Step 17. Turn battery disconnect switch to OFF position (WP 0007). Remove pump house panel S (WP 0540). Open pump house power distribution (WP 0412). Remove circuit breaker P10 (WP 0412). Check for continuity across circuit breaker.

If there is no continuity, replace circuit breaker P10 (WP 0412).

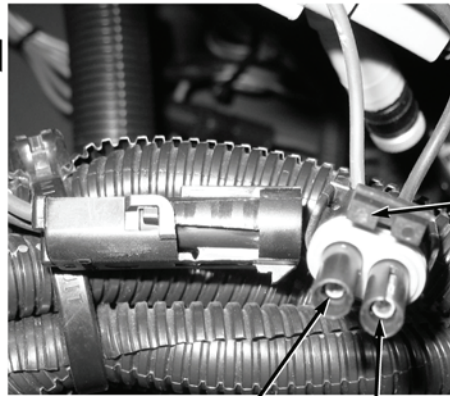
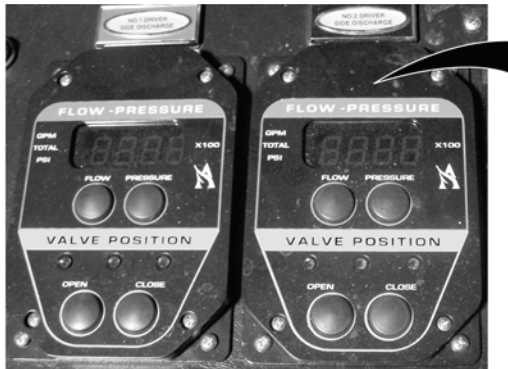
**MALFUNCTION****TEST OR INSPECTION****CORRECTIVE ACTION**

**PUMP HOUSE WIRE HARNESS NO. 2 DRIVER SIDE DISCHARGE VALVE CONTROL CONNECTOR**

**TERMINAL A WIRE 4077**      **TERMINAL B WIRE 3895**



- Step 18. Install circuit breaker P10 (WP 0412). Open pump operator's panel housing (WP 0325). Disconnect pump house wire harness NO. 2 DRIVER SIDE DISCHARGE valve control connector. Turn battery disconnect switch to ON position (WP 0007). Check for 22 to 28 VDC between pump operator's panel wire harness wire 4077 (blue) at NO. 2 DRIVER SIDE DISCHARGE valve control connector, terminal A and a known good ground.

If 22 to 28 VDC are not present, go to Step 20.

- Step 19. Turn battery disconnect switch to OFF position (WP 0007). With a test lead set, check for continuity across wire 3895 (black) from pump operator's panel NO. 2 DRIVER SIDE DISCHARGE valve control connector, terminal B and a known good ground.
- a. If there is continuity, replace No. 2 DRIVER SIDE DISCHARGE valve control (WP 0417).
  - b. If there is no continuity, repair wire 3895 in pump operator's panel wire harness if repairable (TM 9-2320-325-14&P), or replace pump operator's panel wire harness (WP 0459).

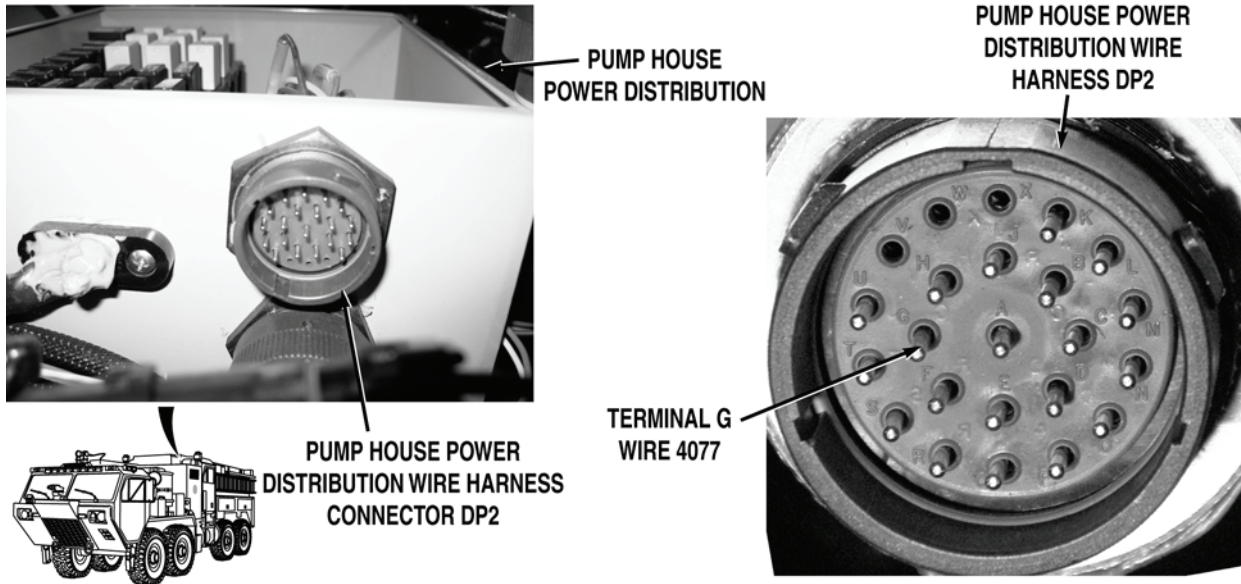
**MALFUNCTION****TEST OR INSPECTION****CORRECTIVE ACTION**

- Step 20. Turn battery disconnect switch to OFF position (WP 0007). Disconnect pump operator's panel wire harness pump house power distribution wire harness connector DP2. Turn battery disconnect switch to ON position (WP 0007). With a test lead set, check for 22 to 28 VDC between pump house power distribution wire harness wire 4077 (blue) at connector DP2, terminal G and a known good ground.
- a. If 22 to 28 VDC are present, repair wire 4077 in pump operator's panel wire harness if repairable (TM 9-2320-325-14&P), or replace pump operator's panel wire harness (WP 0459).
  - b. If 22 to 28 VDC are not present, repair wire 4077 in pump house power distribution wire harness if repairable (TM 9-2320-325-14&P), or replace pump house power distribution wire harness and block (WP 0457).

**END OF TASK****FOLLOW-ON MAINTENANCE**

Remove wheel chocks (TM 9-2320-347-10)

**END OF TASK****END OF WORK PACKAGE**

**FIELD LEVEL MAINTENANCE**

**NO. 3 DISCHARGE VALVE (PASSENGER SIDE) DOES NOT OPERATE PROPERLY**

**INITIAL SETUP:**

**Tools and Special Tools**

Lead Set, Test (WP 0622, Item 21)  
 Tool Kit, General Mechanic's: Automotive  
 (WP 0622, Item 27)

**Personnel Required**

MOS 63B Wheeled vehicle mechanic (2)

**References**

TM 9-2320-325-14&P  
 WP 0004  
 WP 0007  
 WP 0325  
 WP 0388  
 WP 0390

**References (continued)**

WP 0411  
 WP 0412  
 WP 0417  
 WP 0451  
 WP 0453  
 WP 0457  
 WP 0459  
 WP 0460  
 WP 0487  
 WP 0540

**Equipment Conditions**

Water pump engine OFF (WP 0022)  
 Engine OFF (TM 9-2320-347-10)  
 Wheels chocked (TM 9-2320-347-10)

**MALFUNCTION**

**TEST OR INSPECTION**

**CORRECTIVE ACTION**

**NO. 3 DISCHARGE VALVE (PASSENGER SIDE) DOES NOT OPERATE PROPERLY**

**MALFUNCTION**

**TEST OR INSPECTION**

**CORRECTIVE ACTION**

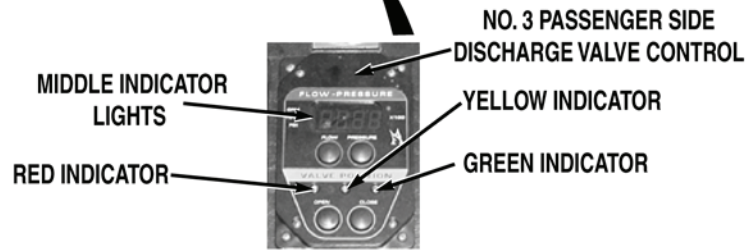

**NOTE**

Ensure batteries are fully charged before performing Step 1.

Step 1. Turn battery disconnect switch to ON position (WP 0007). Check if pump operator's panel NO. 3 PASSENGER SIDE DISCHARGE valve control display illuminates.

If display is not illuminated, go to Step 17.

**MALFUNCTION****TEST OR INSPECTION****CORRECTIVE ACTION**

**NO. 3 PASSENGER SIDE  
DISCHARGE VALVE**

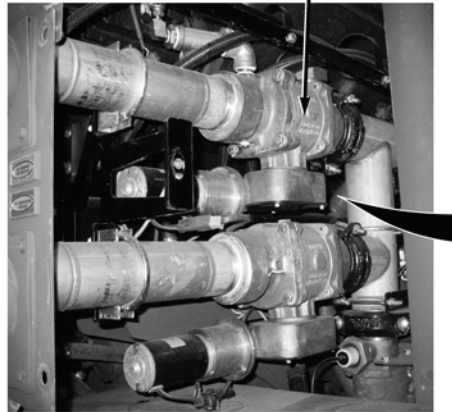

**7/16 in. HEX AT END OF  
VALVE DRIVE ASSEMBLY  
WORM GEARSHAFT**

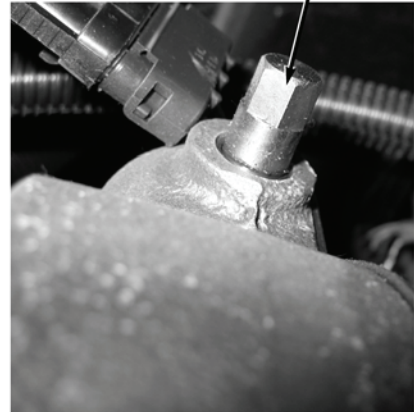
**NOTE**

- Valve operation can be checked by noting vibration of valve assembly or by observing rotation of 7/16 in. hex at end of valve drive assembly worm gearshaft.
- Do not remove cap from NO. 3 PASSENGER SIDE DISCHARGE. Water may be released from system when valve is operated.

Step 2. Remove pump house panel G (WP 0540). While an assistant pushes pump operator's panel NO. 3 PASSENGER SIDE DISCHARGE valve control OPEN and CLOSE buttons (WP 0004), check if No. 3 passenger side discharge valve operates to open and close positions.

If No. 3 passenger side discharge valve does not open and close, go to Step 9.

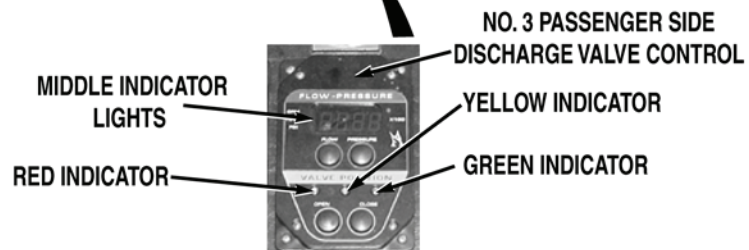
**MALFUNCTION****TEST OR INSPECTION****CORRECTIVE ACTION**

- Step 3. While an assistant monitors operation of No. 3 passenger side discharge valve, push pump operator's panel NO. 3 PASSENGER SIDE DISCHARGE valve control OPEN and CLOSE buttons (WP 0004). Check if NO. 3 PASSENGER SIDE DISCHARGE valve control opened (green) and closed (red) indicators illuminate before No. 3 passenger side discharge valve is fully opened or closed.

If NO. 3 PASSENGER SIDE DISCHARGE valve control indicators illuminate before No. 3 passenger side discharge valve is fully opened or closed, go to Step 13.



**MALFUNCTION****TEST OR INSPECTION****CORRECTIVE ACTION**

**NO. 3 PASSENGER SIDE  
DISCHARGE VALVE**

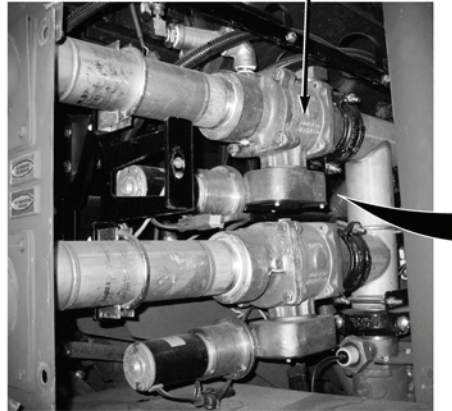

**7/16 in. HEX AT END OF  
VALVE DRIVE ASSEMBLY  
WORM GEARSHAFT**

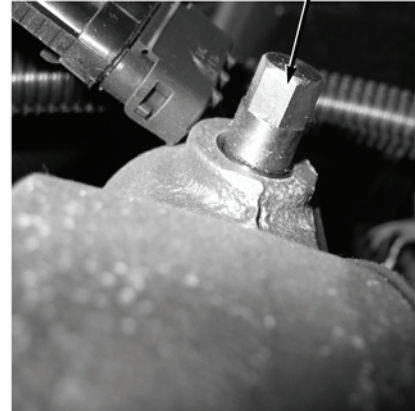
**NOTE**

Valve operation must be checked by observing rotation of 7/16 in. hex at end of valve drive assembly worm gearshaft for Step 4.

- Step 4. While an assistant pushes pump operator's panel NO. 3 PASSENGER SIDE DISCHARGE valve control OPEN and CLOSE buttons (WP 0004), check if No. 3 passenger side discharge valve worm gearshaft moves excessively after valve is fully opened or closed.

If No. 3 passenger side discharge valve worm gearshaft moves excessively after valve is fully opened or closed, remove and re-install No. 3 passenger side discharge valve motor (WP 0388), ensuring all mounting hardware is secure.

**MALFUNCTION**

**TEST OR INSPECTION**

**CORRECTIVE ACTION**

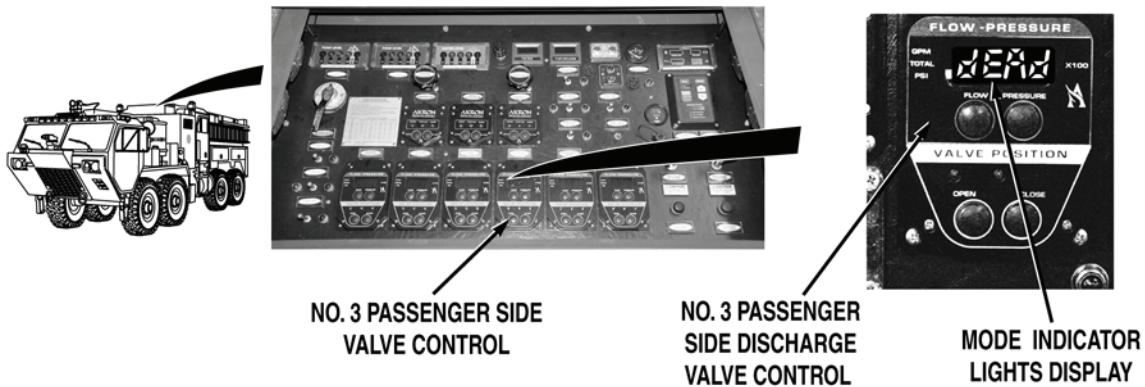

Step 5. Push pump operator's panel NO. 3 PASSENGER SIDE DISCHARGE valve control PRESSURE button. Check if dEAd error is indicated in mode indicator lights display.

If dEAd error message is displayed, replace NO. 3 PASSENGER SIDE DISCHARGE valve control (WP 0417).

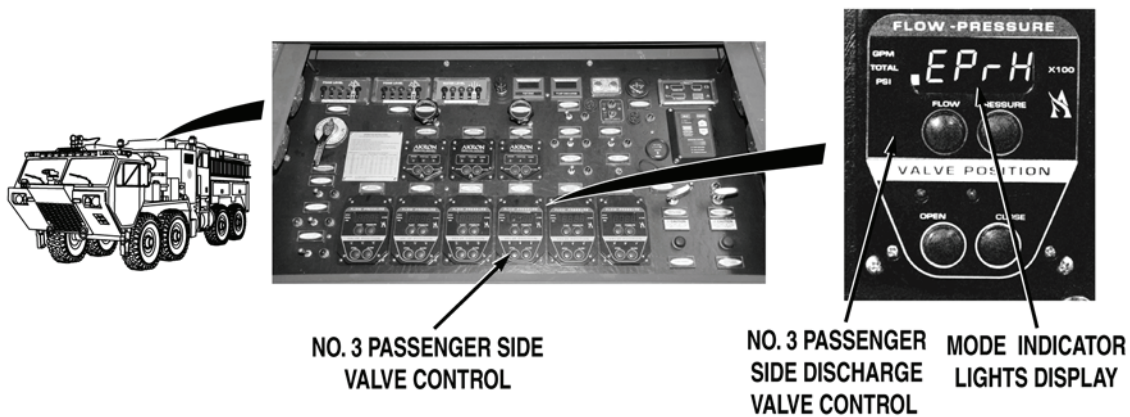

Step 6. Check if EPrL or EPrH error is indicated in mode indicator lights display.

If EPrL or EPrH error message is displayed, go to Step 15.

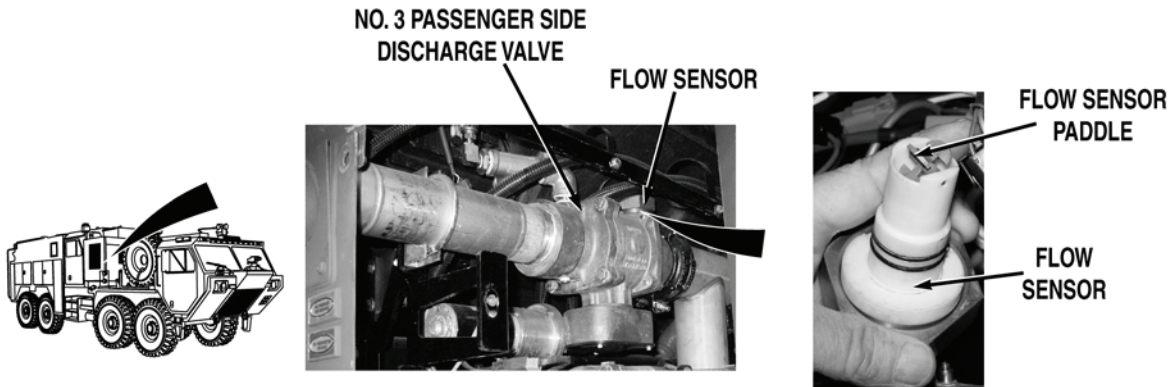
**MALFUNCTION****TEST OR INSPECTION****CORRECTIVE ACTION****WARNING**

**Remove rings, wristwatches, neck chains, and any other jewelry before working around vehicle. Jewelry can catch on equipment and cause serious injury. Jewelry and tools may short across electrical circuits and cause damage to equipment, or severe burns or electrical shock to personnel.**

- Step 7. Remove No. 3 passenger side discharge valve flow sensor (WP 0390). Do not disconnect wires from sensor. Push pump operator's panel NO. 3 PASSENGER SIDE DISCHARGE valve control FLOW button. While an assistant spins flow sensor paddle, check if a flow reading is displayed when flow sensor paddle is spinning.

If a reading of 0 gpm (0 lpm) is displayed when flow sensor paddle is spinning, go to Step 16.

---

**MALFUNCTION****TEST OR INSPECTION****CORRECTIVE ACTION**

---

NO. 3 PASSENGER SIDE  
DISCHARGE VALVE

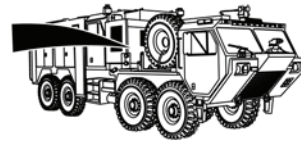
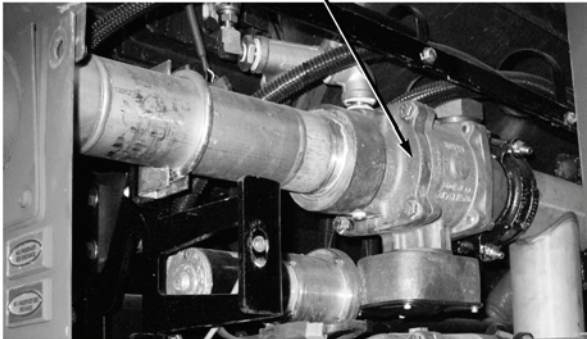

- Step 8. Install No. 3 passenger side discharge valve flow sensor (WP 0390). Remove No. 3 passenger side discharge valve (WP 0487) and inspect for damage and contamination.
- a. If No. 3 passenger side discharge valve is free from damage and contamination, reinstall valve (WP 0487) and go to Step 9.
  - b. If No. 3 passenger side discharge valve is damaged and/or contaminated, replace No. 3 passenger side discharge valve (WP 0487).

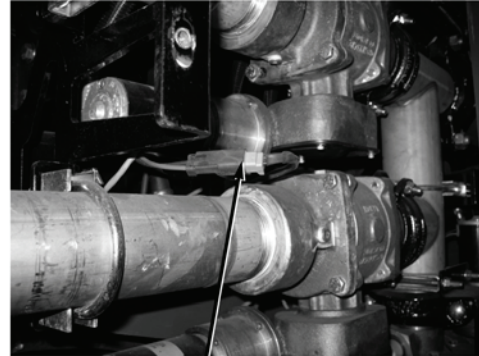
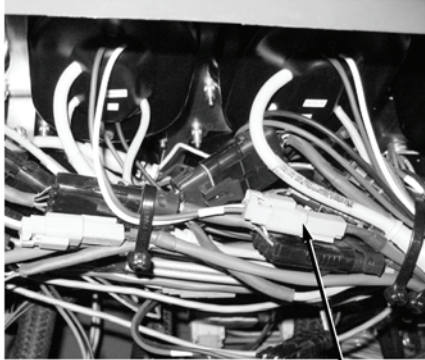
**MALFUNCTION****TEST OR INSPECTION****CORRECTIVE ACTION**

**NO. 3 PASSENGER SIDE  
DISCHARGE VALVE CONTROL  
WIRE HARNESS CONNECTOR**

**NO. 3 PASSENGER SIDE  
DISCHARGE VALVE CONTROL  
WIRE HARNESS CONNECTOR**



- Step 9. Open pump operator's panel housing (WP 0325). Check No. 3 passenger side discharge valve control wire harness at NO. 3 PASSENGER SIDE DISCHARGE valve control and No. 3 passenger side discharge valve motor for loose connections.

If No. 3 passenger side discharge valve control wire harness connectors are loose, reconnect loose connectors (WP 0453).

**NOTE**

- Engine may have to be running to provide enough power to operate valve control. Valve will operate with less voltage, but only yellow indicator light will register on valve control.
- Do not engage water pump engine during this procedure. Valve operations can be checked without water pump operation.
- Valve motor operation can be checked by noting vibration of valve assembly, or by observing rotation of 7/16 in. hex at end of valve drive assembly worm gearshaft.
- Do not remove cap from NO. 3 PASSENGER SIDE DISCHARGE. Water may be released from system when valve is operated.

- Step 10. While an assistant pushes pump operator's panel NO. 3 PASSENGER SIDE DISCHARGE valve control OPEN and CLOSE buttons (WP 0004), check if NO. 3 PASSENGER SIDE DISCHARGE valve control yellow indicator illuminates and No. 3 passenger side discharge valve motor operates.

If indicator illuminates and valve motor operates, replace No. 3 passenger side discharge valve drive assembly (WP 0388).

## MALFUNCTION

## TEST OR INSPECTION

## CORRECTIVE ACTION

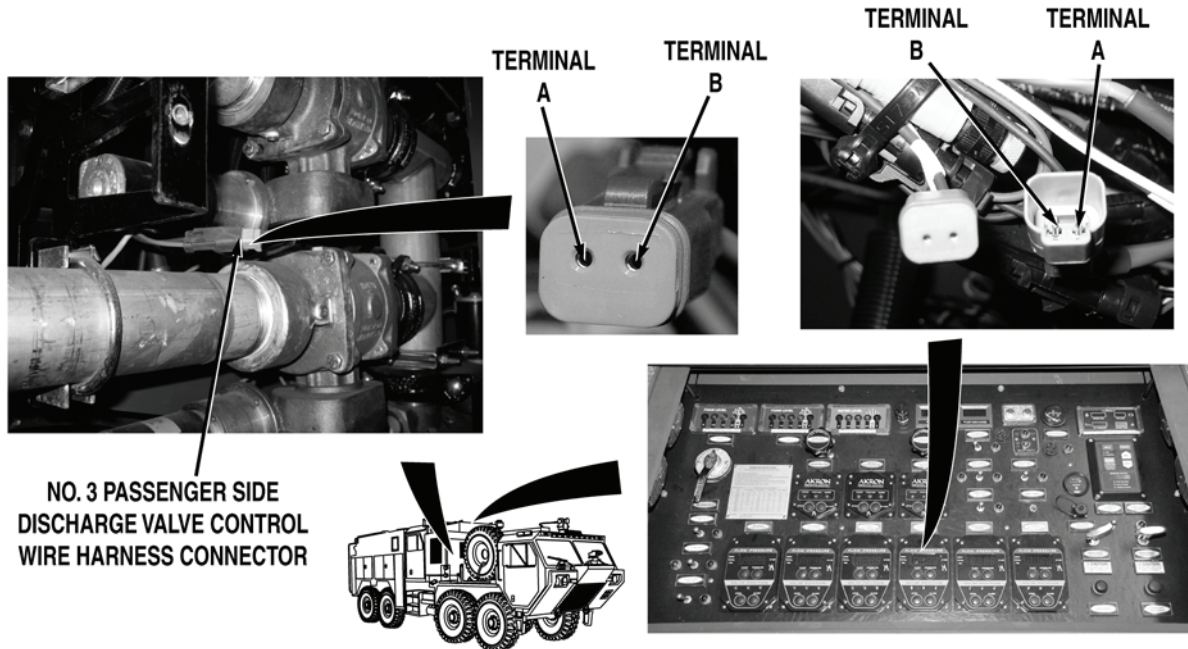
**WARNING**

Remove rings, wristwatches, neck chains, and any other jewelry before working around vehicle. Jewelry can catch on equipment and cause serious injury. Jewelry and tools may short across electrical circuits and cause damage to equipment, or severe burns or electrical shock to personnel.

- Step 11. Turn battery disconnect switch to OFF position (WP 0007). Disconnect No. 3 passenger side discharge valve control wire harness connector from NO. 3 PASSENGER SIDE DISCHARGE valve control. Disconnect No. 3 passenger side discharge valve control wire harness connector from No. 3 passenger side discharge valve motor. With a test lead set, check for continuity across discharge valve control wire harness from terminal to terminal.

If there is no continuity, repair No. 3 passenger side discharge valve control wire harness if repairable (TM 9-2320-325-14&P), or replace No. 3 passenger side discharge valve control wire harness (WP 0453).

---

**MALFUNCTION**  
**TEST OR INSPECTION**  
**CORRECTIVE ACTION**

---

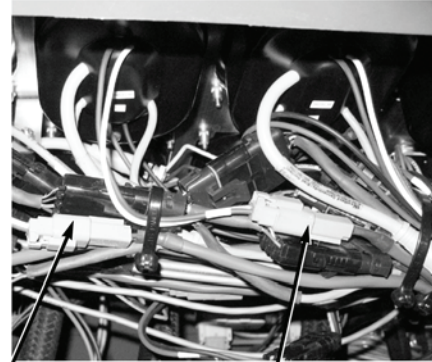
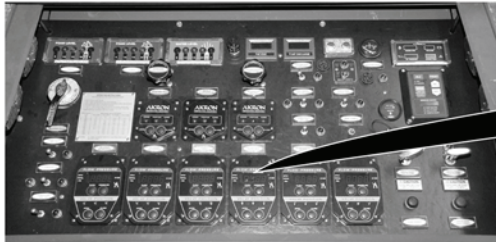

**DRIVER PRE-CONNECT A  
CONTROL VALVE WIRE  
HARNESS CONNECTOR  
(BLUE AND WHITE)**

**NO. 3 PASSENGER SIDE  
DISCHARGE VALVE CONTROL  
WIRE HARNESS CONNECTOR  
(RED AND BLACK)**

- Step 12. Connect No. 3 passenger side discharge valve control wire harness connector to No. 3 passenger side discharge valve motor. Disconnect driver pre-connect A valve control wire harness connector from DRIVER PRE-CONNECT A valve control. Connect No. 3 passenger side discharge valve control wire harness connector to NO. 1 DRIVER PRE-CONNECT A valve control. Turn battery disconnect switch to ON position (WP 0007). While an assistant pushes pump operator's panel NO. 1 DRIVER PRE-CONNECT A valve control OPEN and CLOSE buttons (WP 0004), check if No. 3 passenger side discharge valve operates.
- a. If No. 3 passenger side discharge valve operates, reconnect valve control wire harness connectors to original positions and replace NO. 3 PASSENGER SIDE DISCHARGE valve control (WP 0417).
  - b. If No. 3 passenger side discharge valve does not operate, reconnect valve control wire harness connectors to original positions and replace No. 3 passenger side discharge valve motor (WP 0388).

## MALFUNCTION

## TEST OR INSPECTION

## CORRECTIVE ACTION

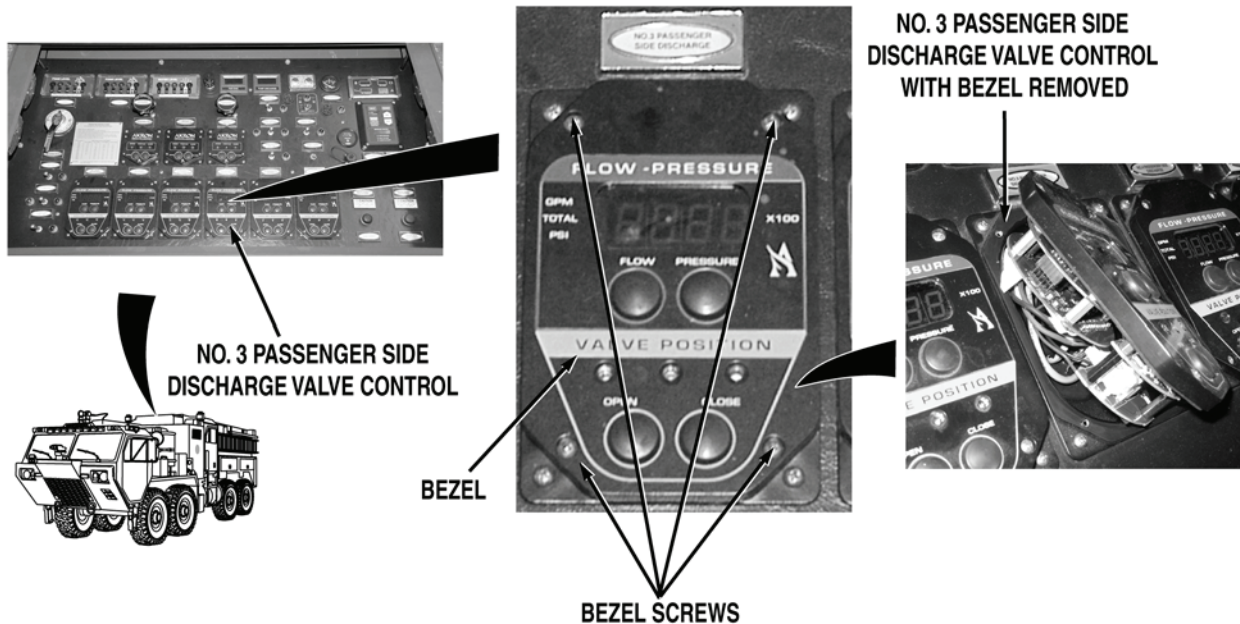

- Step 13. Remove four screws and bezel from pump operator's panel NO. 3 PASSENGER SIDE DISCHARGE valve control. Check for signs of water and moisture damage.

If NO. 3 PASSENGER SIDE DISCHARGE valve control shows evidence of water and moisture damage, replace NO. 3 PASSENGER SIDE DISCHARGE valve control (WP 0417).

- Step 14. Install bezel and four screws on NO. 3 PASSENGER SIDE DISCHARGE valve control. Remove No. 3 passenger side discharge valve (WP 0487) and inspect it for binding, damage, and contamination.
- a. If No. 3 passenger side discharge valve is free from binding, damage, and contamination, reinstall valve (WP 0487) and replace No. 3 passenger side discharge valve motor and drive assembly (WP 0388).
  - b. If No. 3 passenger side discharge valve is binding, damaged, and/or contaminated, replace No. 3 passenger side discharge valve (WP 0487).



---

**MALFUNCTION**  
**TEST OR INSPECTION**  
**CORRECTIVE ACTION**

---

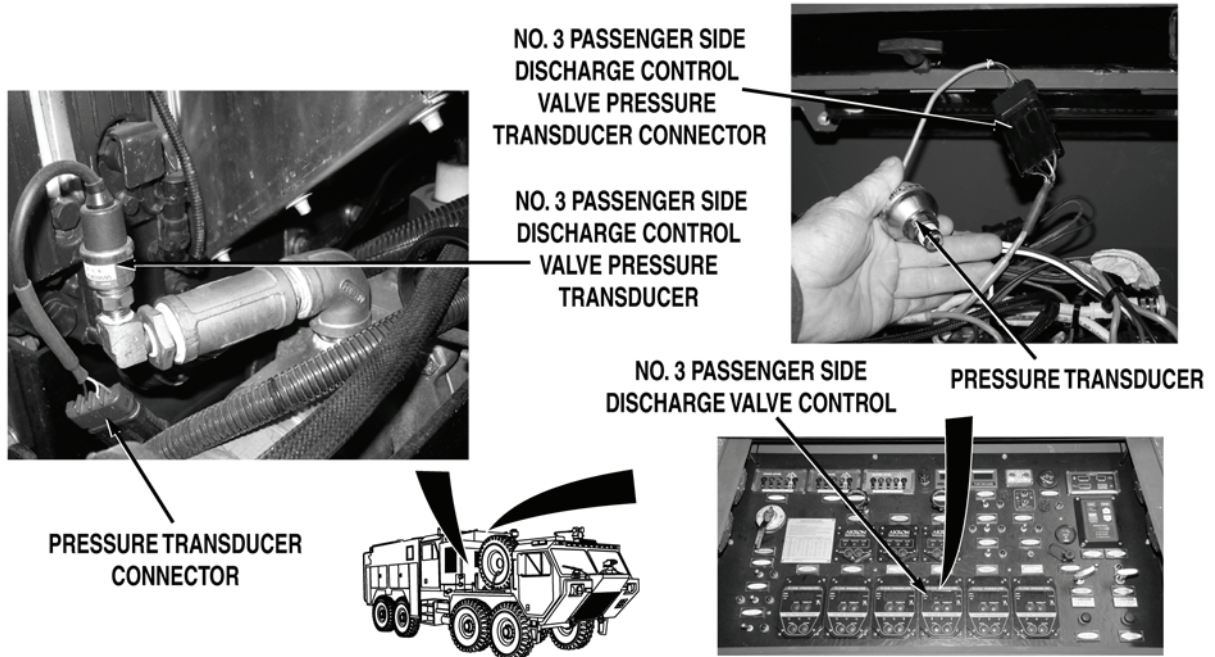

**WARNING**



**Remove rings, wristwatches, neck chains, and any other jewelry before working around vehicle. Jewelry can catch on equipment and cause serious injury. Jewelry and tools may short across electrical circuits and cause damage to equipment, or severe burns or electrical shock to personnel.**

- Step 15. Remove No. 3 passenger side discharge valve pressure transducer (WP 0411). Disconnect No. 3 passenger side discharge valve pressure transducer wire harness from NO. 3 PASSENGER SIDE DISCHARGE valve control. Connect pressure transducer to NO. 3 PASSENGER DISCHARGE valve control (removing wire harness from circuit). Check if error message EPrL or EPrH is displayed.
- a. If EPrL or EPrH error message is displayed, replace No. 3 passenger side valve discharge pressure transducer (WP 0411).
  - b. If EPrL or EPrH error message is not displayed, repair pressure transducer wire harness if repairable (TM 9-2320-325-14&P), or replace No. 3 passenger side discharge valve pressure transducer wire harness (WP 0460).

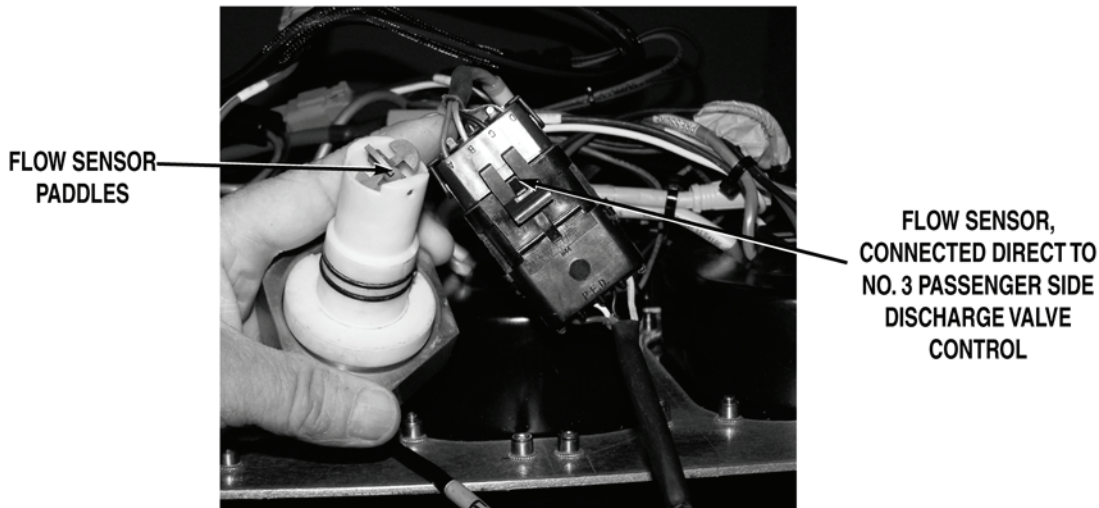
**MALFUNCTION****TEST OR INSPECTION****CORRECTIVE ACTION****WARNING**

**Remove rings, wristwatches, neck chains, and any other jewelry before working around vehicle. Jewelry can catch on equipment and cause serious injury. Jewelry and tools may short across electrical circuits and cause damage to equipment, or severe burns or electrical shock to personnel.**

- Step 16. Disconnect No. 3 passenger side discharge valve flow sensor wire harness from No. 3 passenger side discharge flow sensor. Disconnect No. 3 passenger side discharge valve flow sensor wire harness from NO. 3 PASSENGER DISCHARGE valve control. Connect No. 3 passenger side discharge flow sensor to NO. 3 PASSENGER DISCHARGE valve control (removing wire harness from circuit). While an assistant spins flow sensor paddle wheel, check if a flow reading is displayed when flow sensor paddle is spinning.
- a. If a flow reading is displayed when flow sensor paddle is spinning, repair flow sensor wire harness if repairable (TM 9-2320-325-14&P), or replace No. 3 passenger side discharge valve flow sensor wire harness (WP 0451).
  - b. If a flow reading is not displayed when flow sensor paddle is spinning, replace No. 3 passenger side discharge valve flow sensor (WP 0390).

**MALFUNCTION**  
**TEST OR INSPECTION**  
**CORRECTIVE ACTION**

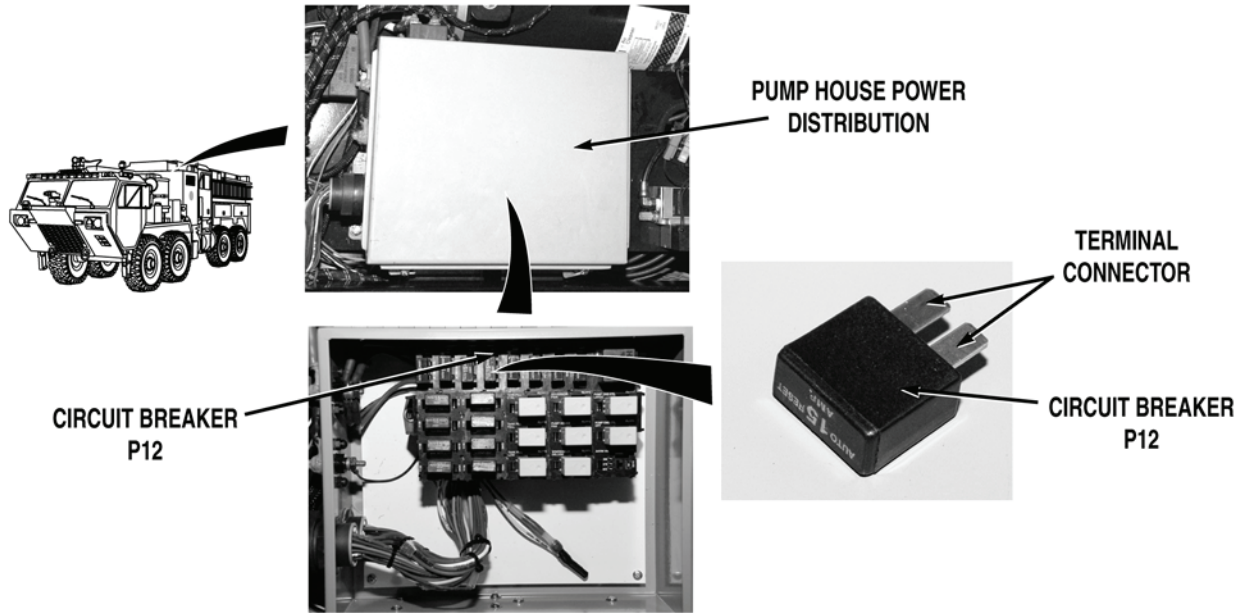

**WARNING**



**Remove rings, wristwatches, neck chains, and any other jewelry before working around vehicle. Jewelry can catch on equipment and cause serious injury. Jewelry and tools may short across electrical circuits and cause damage to equipment, or severe burns or electrical shock to personnel.**

- Step 17. Turn battery disconnect switch to OFF position (WP 0007). Remove pump house panel S (WP 0540). Open pump house power distribution (WP 0412). Remove circuit breaker P12 (WP 0412). Check for continuity across circuit breaker.

If there is no continuity, replace circuit breaker P12 (WP 0412).

**MALFUNCTION****TEST OR INSPECTION****CORRECTIVE ACTION**

Step 18. Install circuit breaker P12 (WP 0412). Open pump operator's panel housing (WP 0325). Disconnect pump house wire harness NO. 3 PASSENGER SIDE DISCHARGE valve control connector. Turn battery disconnect switch to ON position (WP 0007). Check for 22 to 28 VDC between pump operator's panel wire harness wire 4079 (yellow) at NO. 3 PASSENGER SIDE DISCHARGE valve control connector, terminal A and a known good ground.

If 22 to 28 VDC are not present, go to Step 20.

Step 19. Turn battery disconnect switch to OFF position (WP 0007). With a test lead set, check for continuity across wire 3895 (black) from pump operator's panel NO. 3 PASSENGER SIDE DISCHARGE valve control connector, terminal B and a known good ground.

- a. If there is continuity, replace No. 3 PASSENGER SIDE DISCHARGE valve control (WP 0417).
- b. If there is no continuity, repair wire 3895 in pump operator's panel wire harness if repairable (TM 9-2320-325-14&P), or replace pump operator's panel wire harness (WP 0459).

**MALFUNCTION****TEST OR INSPECTION****CORRECTIVE ACTION**

- Step 20. Turn battery disconnect switch to OFF position (WP 0007). Disconnect pump operator's panel wire harness pump house power distribution wire harness connector DP2. Turn battery disconnect switch to ON position (WP 0007). With a test lead set, check for 22 to 28 VDC between pump house power distribution wire harness wire 4079 (yellow) at connector DP2, terminal C and a known good ground.
- a. If 22 to 28 VDC are present, repair wire 4079 in pump house wire harness if repairable (TM 9-2320-325-14&P), or replace pump operator's panel wire harness (WP 0459).
  - b. If 22 to 28 VDC are not present, repair wire 4079 in pump house power distribution wire harness if repairable (TM 9-2320-325-14&P), or replace pump house power distribution wire harness and block (WP 0457).

**END OF TASK****FOLLOW-ON MAINTENANCE**

Remove wheel chocks (TM 9-2320-347-10)

**END OF TASK****END OF WORK PACKAGE**



**FIELD LEVEL MAINTENANCE**

**NO. 4 DISCHARGE VALVE (PASSENGER SIDE) DOES NOT OPERATE PROPERLY**

**INITIAL SETUP:**

**Tools and Special Tools**

Lead Set, Test (WP 0622, Item 21)  
 Tool Kit, General Mechanic's: Automotive  
 (WP 0622, Item 27)

**Personnel Required**

MOS 63B Wheeled vehicle mechanic (2)

**References**

TM 9-2320-325-14&P  
 WP 0004  
 WP 0007  
 WP 0325  
 WP 0388  
 WP 0390  
 WP 0411

**References (continued)**

WP 0412  
 WP 0417  
 WP 0451  
 WP 0453  
 WP 0457  
 WP 0459  
 WP 0460  
 WP 0488  
 WP 0539  
 WP 0540

**Equipment Conditions**

Water pump engine OFF (WP 0022)  
 Engine OFF (TM 9-2320-347-10)  
 Wheels chocked (TM 9-2320-347-10)

**MALFUNCTION**

**TEST OR INSPECTION**

**CORRECTIVE ACTION**

**NO. 4 DISCHARGE VALVE (PASSENGER SIDE) DOES NOT OPERATE PROPERLY**

**MALFUNCTION**

**TEST OR INSPECTION**

**CORRECTIVE ACTION**

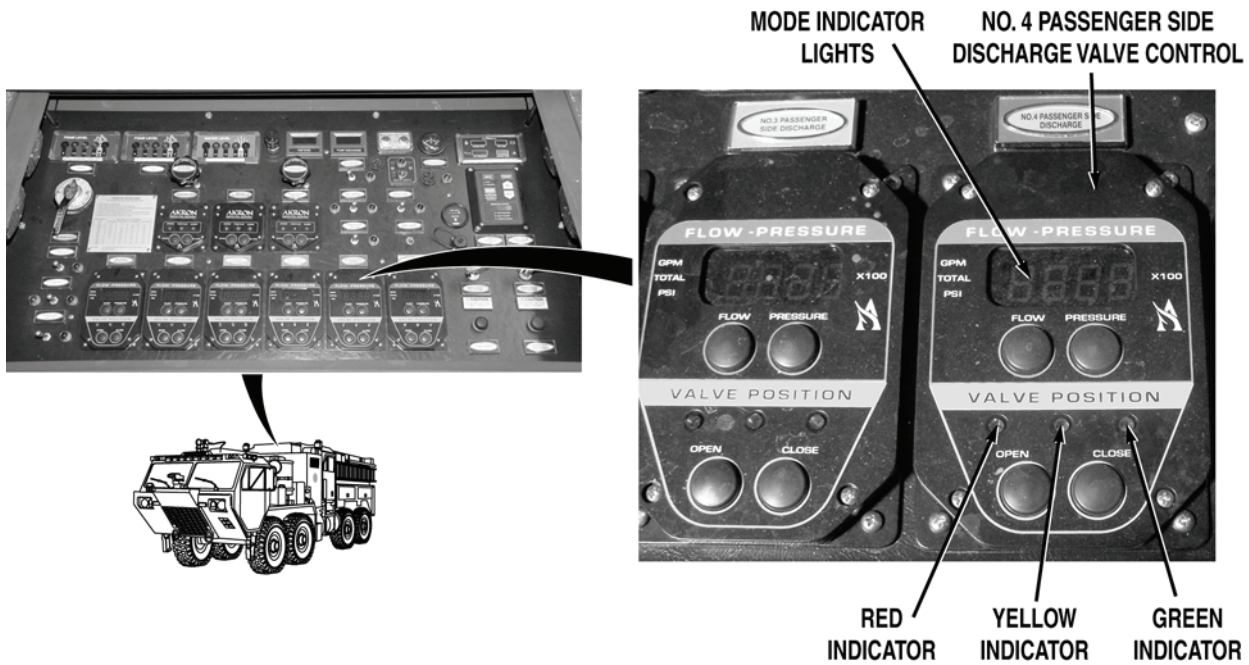

**NOTE**

Ensure batteries are fully charged before performing Step 1.

- Step 1. Turn battery disconnect switch to ON position (WP 0007). Check if pump operator's panel NO. 4 PASSENGER SIDE DISCHARGE valve control display illuminates.

If display is not illuminated, go to Step 17.



---

**MALFUNCTION**  
**TEST OR INSPECTION**  
**CORRECTIVE ACTION**

---

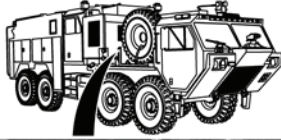

**NO. 4 PASSENGER SIDE  
DISCHARGE VALVE**

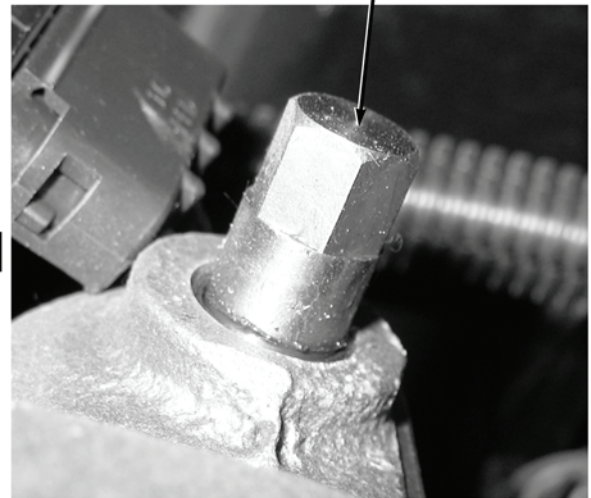

**7/16 in. HEX END OF  
VALVE DRIVE ASSEMBLY  
WORM GEARSHAFT**

**NOTE**

- Valve operation can be checked by noting vibration of valve assembly or by observing rotation of 7/16 in. hex at end of valve drive assembly worm gearshaft.
- Do not remove cap from NO. 4 PASSENGER SIDE DISCHARGE. Water may be released from system when valve is operated.

Step 2. Remove pump house panel G (WP 0540). While an assistant pushes pump operator's panel NO. 4 PASSENGER SIDE DISCHARGE valve control OPEN and CLOSE buttons (WP 0004), check if No. 4 passenger side discharge valve operates to open and close positions.

If No. 4 passenger side discharge valve does not operate to open and close positions, go to Step 9.

**MALFUNCTION**

**TEST OR INSPECTION**

**CORRECTIVE ACTION**

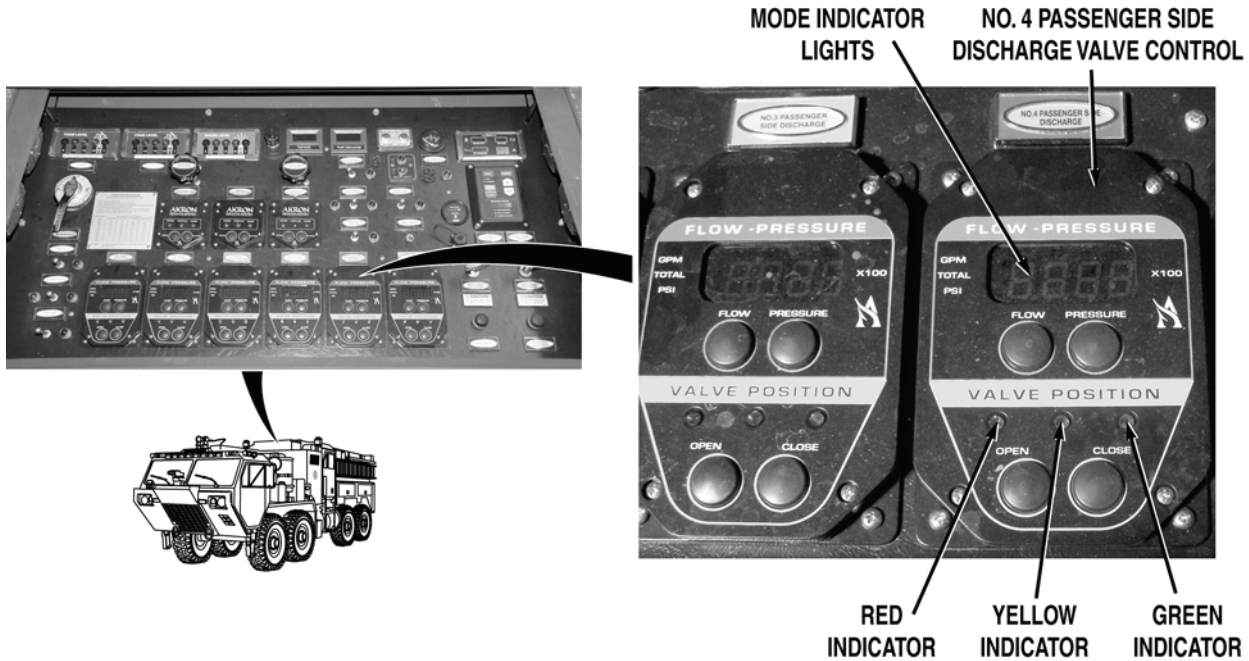

Step 3. While an assistant monitors operation of No. 4 passenger side discharge valve, push pump operator's panel NO. 4 PASSENGER SIDE DISCHARGE valve control OPEN and CLOSE buttons (WP 0004). Check if NO. 4 PASSENGER SIDE DISCHARGE valve control open (green) and close (red) indicators illuminate before No. 4 passenger side discharge valve is fully opened or closed.

If NO. 4 PASSENGER SIDE DISCHARGE valve control indicators illuminate before No. 4 passenger side discharge valve is fully opened or closed, go to Step 13.

---

**MALFUNCTION**  
**TEST OR INSPECTION**  
**CORRECTIVE ACTION**

---

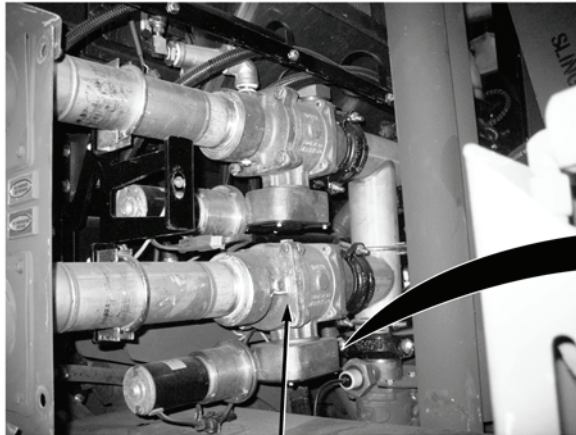
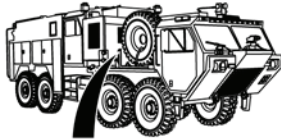

**NO. 4 PASSENGER SIDE  
DISCHARGE VALVE**

**7/16 in. HEX END OF  
VALVE DRIVE ASSEMBLY  
WORM GEARSHAFT**

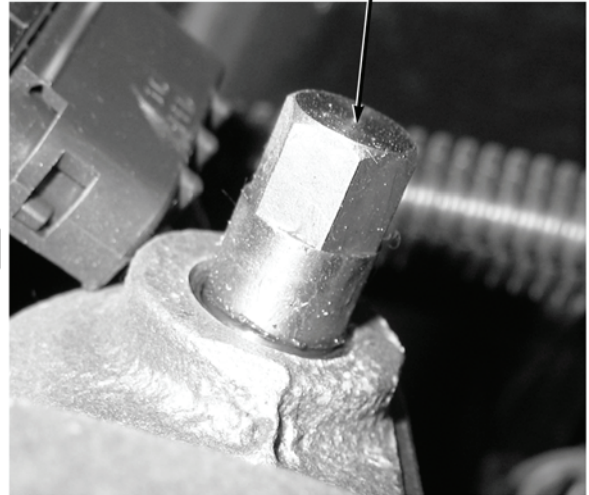

**NOTE**

Valve operation must be checked by observing rotation of 7/16 in. hex at end of valve drive assembly worm gearshaft for Step 4.

- Step 4. While an assistant pushes pump operator's panel NO. 4 PASSENGER SIDE DISCHARGE valve control OPEN and CLOSE buttons (WP 0004), check if No. 4 passenger side discharge valve worm gearshaft moves excessively after valve is fully opened or closed.

If No. 4 passenger side discharge valve worm gearshaft moves excessively after valve is fully opened or closed, remove and re-install No. 4 passenger side discharge valve motor (WP 0388), ensuring all mounting hardware is secure.

**MALFUNCTION**

**TEST OR INSPECTION**

**CORRECTIVE ACTION**

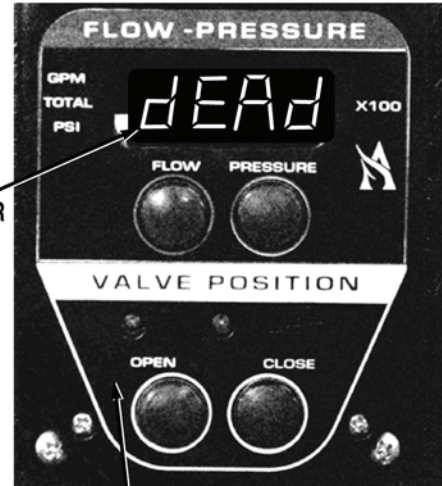
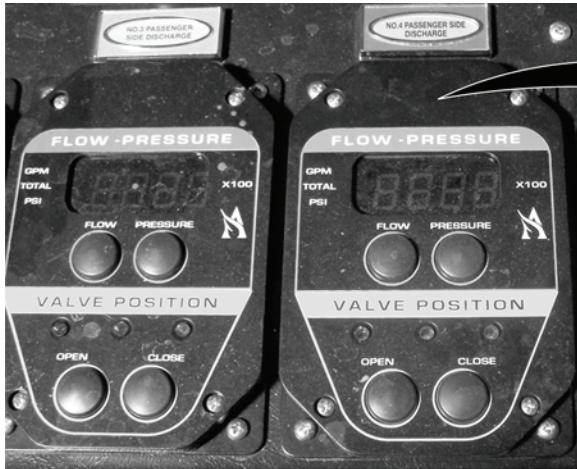

MODE INDICATOR  
LIGHTS DISPLAY

NO. 4 PASSENGER SIDE  
DISCHARGE VALVE CONTROL



Step 5. Push pump operator's panel NO. 4 PASSENGER SIDE DISCHARGE valve control PRESSURE button. Check if dEAd error is indicated in mode indicator lights display.

If dEAd error message is displayed, replace NO. 4 PASSENGER SIDE DISCHARGE valve control (WP 0417).

**MALFUNCTION**

**TEST OR INSPECTION**

**CORRECTIVE ACTION**

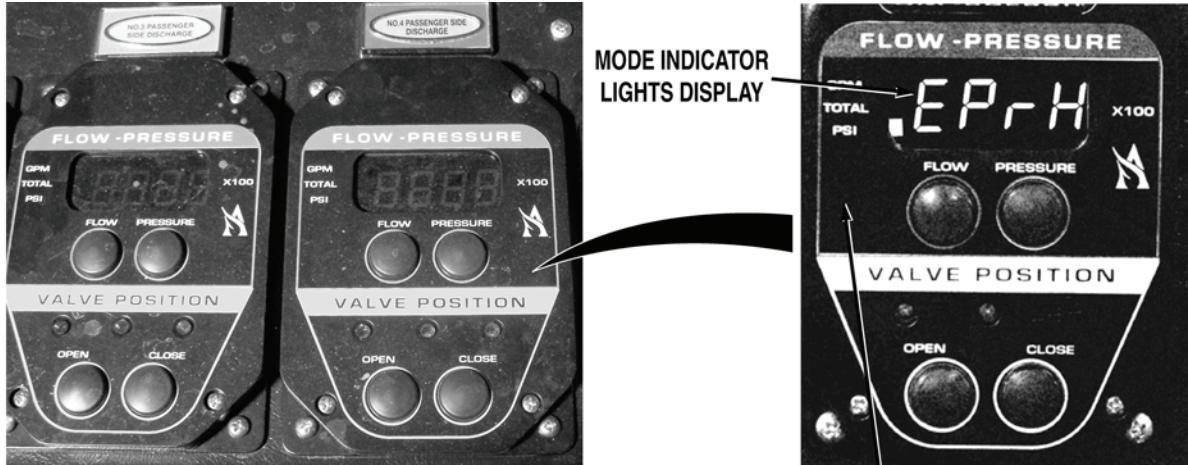

**NO. 4 PASSENGER SIDE  
DISCHARGE VALVE CONTROL**

Step 6. Check if EPrL or EPrH error is indicated in mode indicator lights display.

If EPrL or EPrH error message is displayed, go to Step 15.

## MALFUNCTION

## TEST OR INSPECTION

## CORRECTIVE ACTION

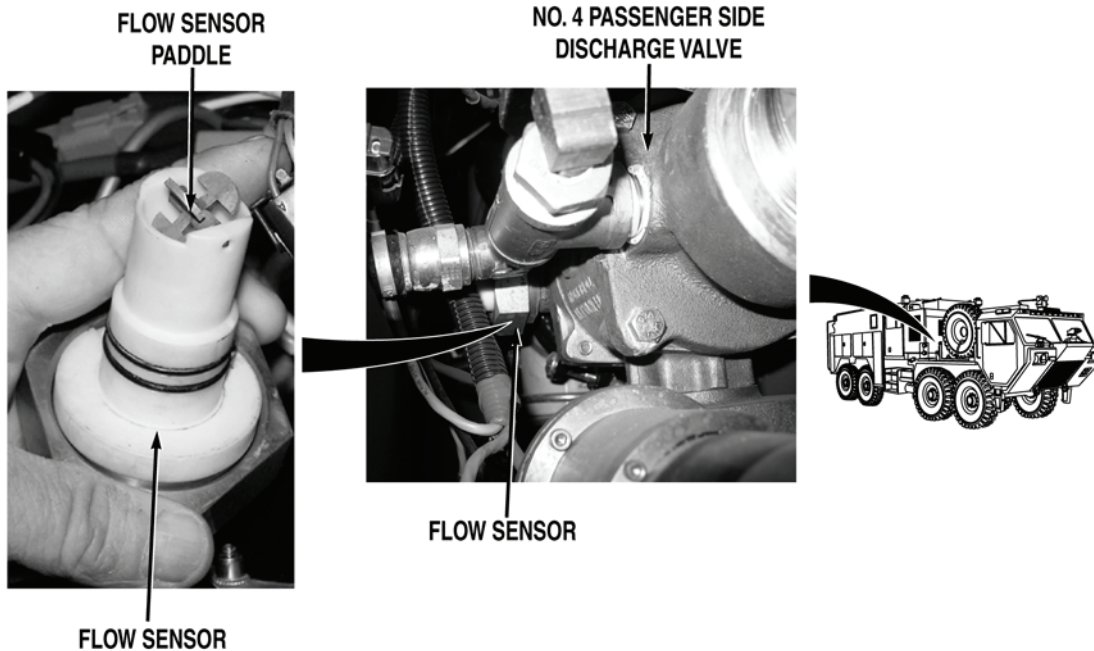
**WARNING**

Remove rings, wristwatches, neck chains, and any other jewelry before working around vehicle. Jewelry can catch on equipment and cause serious injury. Jewelry and tools may short across electrical circuits and cause damage to equipment, or severe burns or electrical shock to personnel.

- Step 7. Remove No. 4 passenger side discharge valve flow sensor (WP 0390). Do not disconnect wires from sensor. Push pump operator's panel NO. 4 PASSENGER SIDE DISCHARGE valve control FLOW button. While an assistant spins flow sensor paddle, check if a flow reading is displayed when flow sensor paddle is spinning.

If a reading of 0 gpm (0 lpm) is displayed when flow sensor paddle is spinning, go to Step 16.

---

MALFUNCTION	TEST OR INSPECTION	CORRECTIVE ACTION
-------------	--------------------	-------------------

---

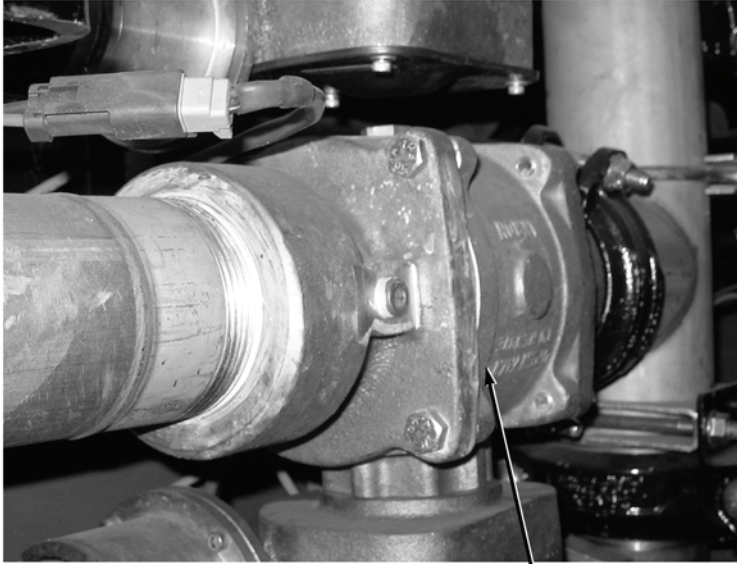

**NO. 4 PASSENGER DISCHARGE VALVE**

- Step 8. Install No. 4 passenger side discharge valve flow sensor (WP 0390). Remove No. 4 passenger side discharge valve (WP 0488) and inspect it for damage and contamination.
- If No. 4 passenger side discharge valve is free from damage and contamination, reinstall valve (WP 0488) and go to Step 9.
  - If No. 4 passenger side discharge valve is damaged and/or contaminated, repair (WP 0388) or replace No. 2 passenger side discharge valve (WP 0488).

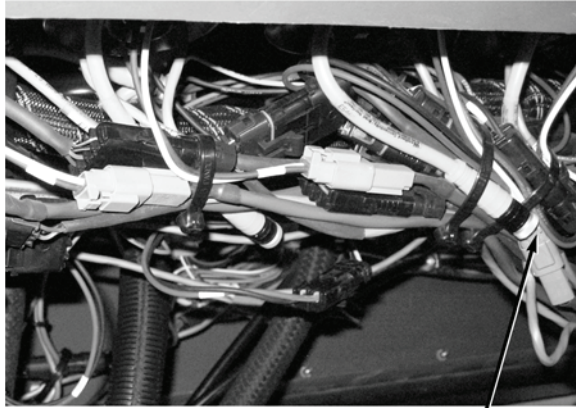
**MALFUNCTION****TEST OR INSPECTION****CORRECTIVE ACTION**

**NO. 4 PASSENGER  
SIDE DISCHARGE  
VALVE CONTROL WIRE  
HARNESS CONNECTOR**

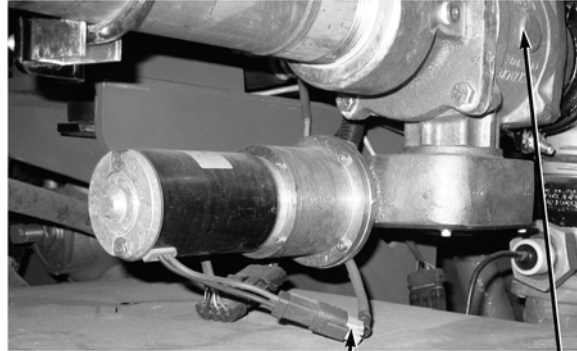

**NO. 4 PASSENGER  
SIDE DISCHARGE  
VALVE CONTROL  
WIRE HARNESS  
CONNECTOR**

**NO. 4 PASSENGER  
SIDE DISCHARGE  
VALVE**



- Step 9. Open pump operator's panel housing (WP 0325). Check No. 4 passenger side discharge valve control wire harness at NO. 4 PASSENGER SIDE DISCHARGE valve control and No. 4 passenger side discharge valve motor for loose connections.

If No. 4 passenger side discharge valve control wire harness connectors are loose, reconnect loose connectors (WP 0453).

**NOTE**

- Engine may have to be running to provide enough power to operate valve control. Valve will operate with less voltage, but only yellow indicator light will register on valve control.
- Do not engage water pump engine during this procedure. Valve operations can be checked without water pump operation.
- Valve motor operation can be checked by noting vibration of valve assembly, or by observing rotation of 7/16 in. hex at end of valve drive assembly worm gearshaft.
- Do not remove cap from NO. 4 PASSENGER SIDE DISCHARGE. Water may be released from system when valve is operated.

- Step 10. While an assistant pushes pump operator's panel NO. 4 PASSENGER SIDE DISCHARGE valve control OPEN and CLOSE buttons (WP 0004), check if NO. 4 PASSENGER SIDE DISCHARGE valve control yellow indicator illuminates and No. 4 passenger side discharge valve motor operates.

If indicator illuminates and valve motor operates, replace No. 4 passenger side discharge valve drive assembly (WP 0388).



MALFUNCTION	TEST OR INSPECTION	CORRECTIVE ACTION
-------------	--------------------	-------------------

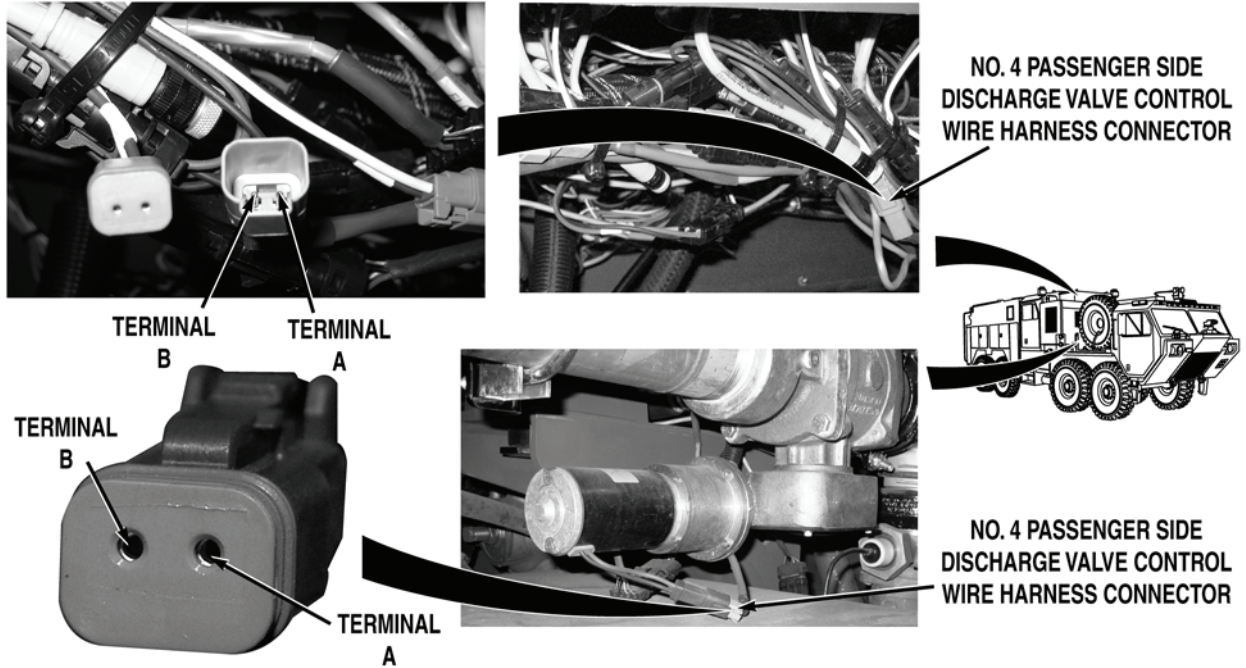

**WARNING**



Remove rings, wristwatches, neck chains, and any other jewelry before working around vehicle. Jewelry can catch on equipment and cause serious injury. Jewelry and tools may short across electrical circuits and cause damage to equipment, or severe burns or electrical shock to personnel.

- Step 11. Turn battery disconnect switch to OFF position (WP 0007). Disconnect No. 4 passenger side discharge valve control wire harness connector from NO. 4 PASSENGER SIDE DISCHARGE valve control. Disconnect No. 4 passenger side discharge valve control wire harness connector from No. 4 passenger side discharge valve motor. With a test lead set, check for continuity across discharge valve control wire harness from terminal to terminal.

If there is no continuity, repair No. 4 passenger side discharge valve control wire harness if repairable (TM 9-2320-325-14&P), or replace No. 4 passenger side discharge valve control wire harness (WP 0453).

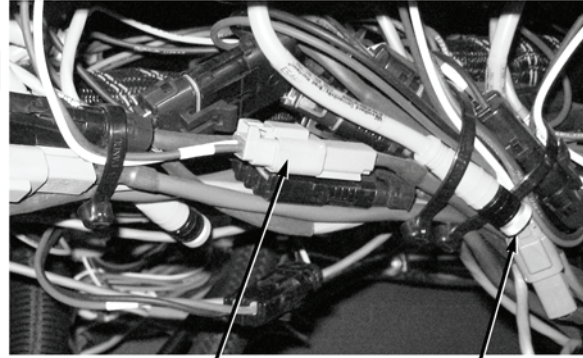
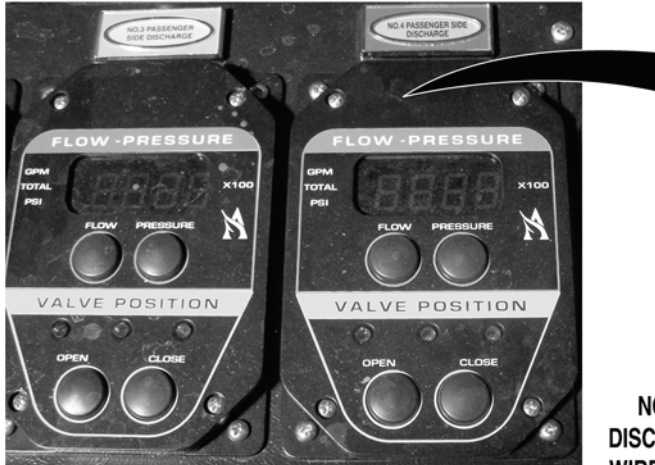
**MALFUNCTION****TEST OR INSPECTION****CORRECTIVE ACTION**

**NO. 3 PASSENGER SIDE  
DISCHARGE VALVE CONTROL  
WIRE HARNESS CONNECTOR  
(BLUE AND WHITE)**

**NO. 4 PASSENGER  
SIDE DISCHARGE VALVE  
CONTROL WIRE HARNESS  
CONNECTOR  
(RED AND BLACK)**

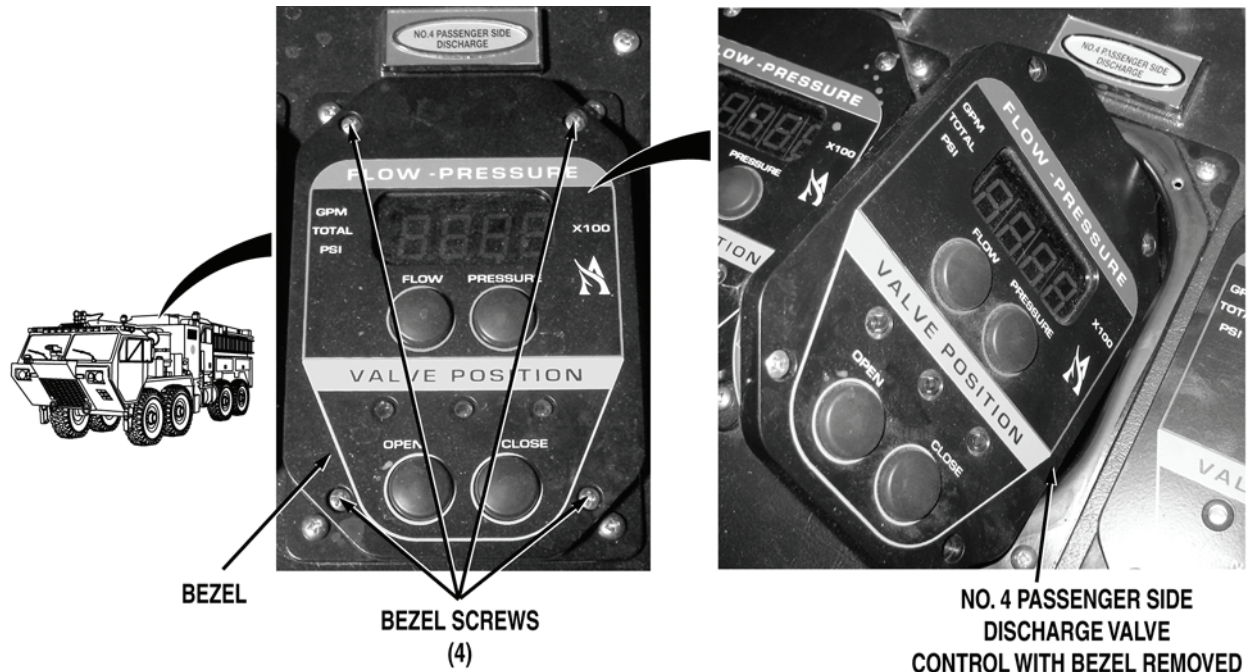

- Step 12. Open pump operator's panel housing (WP 0325). Connect No. 4 passenger side discharge valve control wire harness connector to No. 4 passenger side discharge valve motor. Disconnect No. 3 driver side discharge valve control wire harness connector from NO. 3 DRIVER SIDE DISCHARGE valve control. Connect No. 4 passenger side discharge valve control wire harness connector to NO. 3 DRIVER SIDE DISCHARGE valve control. Turn battery disconnect switch to ON position (WP 0007). While an assistant pushes pump operator's panel NO. 3 DRIVER SIDE DISCHARGE valve control OPEN and CLOSE buttons (WP 0004), check if No. 4 passenger side discharge valve operates.
- a. If No. 4 passenger side discharge valve operates, reconnect valve control wire harness connectors to original positions and replace NO. 4 PASSENGER SIDE DISCHARGE valve control (WP 0417).
  - b. If No. 4 passenger side discharge valve does not operate, reconnect valve control wire harness connectors to original positions and replace No. 4 passenger side discharge valve motor (WP 0388).

**MALFUNCTION****TEST OR INSPECTION****CORRECTIVE ACTION**

- Step 13. Remove four screws and bezel from pump operator's panel NO. 4 PASSENGER SIDE DISCHARGE valve control. Check for signs of water and moisture damage.

If NO. 4 PASSENGER SIDE DISCHARGE valve control shows evidence of water and moisture damage, replace NO. 4 PASSENGER SIDE DISCHARGE valve control (WP 0417).

- Step 14. Install bezel and four screws on NO. 4 PASSENGER SIDE DISCHARGE valve control. Remove No. 4 passenger side discharge valve (WP 0488) and inspect it for binding, damage, and contamination.
- a. If No. 4 passenger side discharge valve is free from binding, damage, and contamination, reinstall valve (WP 0488) and replace No. 4 passenger side discharge valve motor and drive assembly (WP 0388).
  - b. If No. 4 passenger side discharge valve is binding, damaged, and/or contaminated, replace No. 4 passenger side discharge valve (WP 0488).

## MALFUNCTION

## TEST OR INSPECTION

## CORRECTIVE ACTION



NO. 4 PASSENGER  
SIDE PRESSURE  
TRANSDUCER

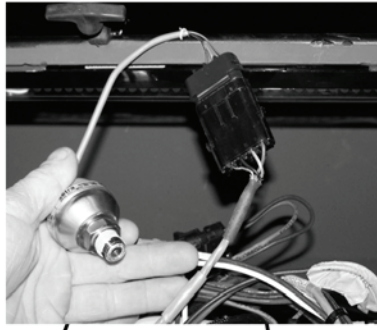

PRESSURE  
TRANSDUCER

PRESSURE  
TRANSDUCER WITH  
WIRE HARNESS REMOVED,  
DIRECT CONNECTION  
TO NO. 4 PASSENGER SIDE  
DISCHARGE VALVE  
CONTROL

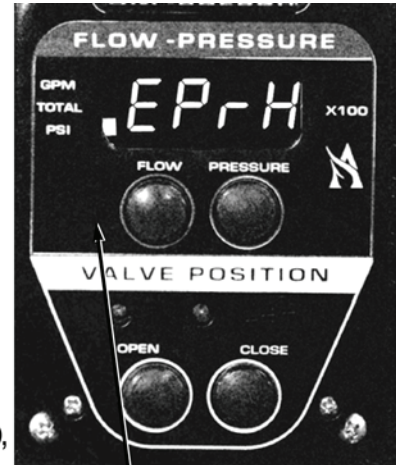

NO. 4 PASSENGER SIDE  
DISCHARGE VALVE CONTROL

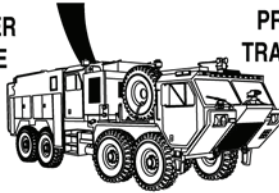
**WARNING**

Remove rings, wristwatches, neck chains, and any other jewelry before working around vehicle. Jewelry can catch on equipment and cause serious injury. Jewelry and tools may short across electrical circuits and cause damage to equipment, or severe burns or electrical shock to personnel.

- Step 15. Open pump operator's panel housing (WP 0325). Remove No. 4 passenger side discharge valve pressure transducer (WP 0411). Disconnect No. 4 passenger side discharge valve pressure transducer wire harness from NO. 4 PASSENGER SIDE DISCHARGE valve control. Connect pressure transducer to NO. 4 PASSENGER DISCHARGE valve control (removing wire harness from circuit). Check if error message EPrL or EPrH is displayed.
- a. If EPrL or EPrH error message is displayed, replace No. 4 passenger side valve discharge pressure transducer (WP 0411).
  - b. If EPrL or EPrH error message is not displayed, repair pressure transducer wire harness if repairable (TM 9-2320-325-14&P), or replace No. 4 passenger side discharge valve pressure transducer wire harness (WP 0460).

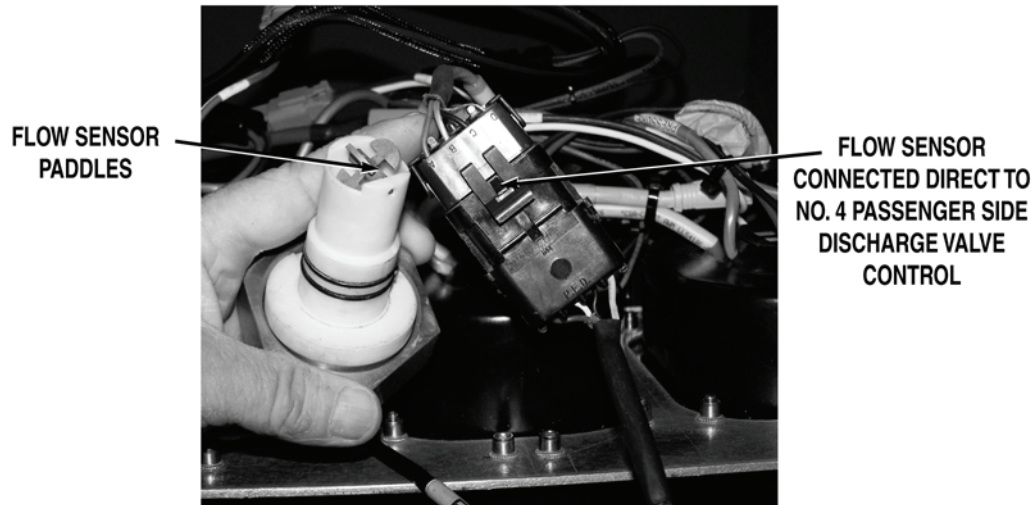
**MALFUNCTION****TEST OR INSPECTION****CORRECTIVE ACTION****WARNING**

**Remove rings, wristwatches, neck chains, and any other jewelry before working around vehicle. Jewelry can catch on equipment and cause serious injury. Jewelry and tools may short across electrical circuits and cause damage to equipment, or severe burns or electrical shock to personnel.**

- Step 16. Disconnect No. 4 passenger side discharge valve flow sensor wire harness from No. 4 passenger side discharge flow sensor. Disconnect No. 4 passenger side discharge valve flow sensor wire harness from NO. 4 PASSENGER DISCHARGE valve control. Connect No. 4 passenger side discharge flow sensor to NO. 4 PASSENGER DISCHARGE valve control (removing wire harness from circuit). While an assistant spins flow sensor paddle wheel, check if a flow reading is displayed when flow sensor paddle is spinning.
- a. If a flow reading is displayed when flow sensor paddle is spinning, repair flow sensor wire harness if repairable (TM 9-2320-325-14&P), or replace No. 4 passenger side discharge valve flow sensor wire harness (WP 0451).
  - b. If a flow reading is not displayed when flow sensor paddle is spinning, replace No. 4 passenger side discharge valve flow sensor (WP 0390).

**MALFUNCTION**

**TEST OR INSPECTION**

**CORRECTIVE ACTION**



PUMP HOUSE  
POWER  
DISTRIBUTION

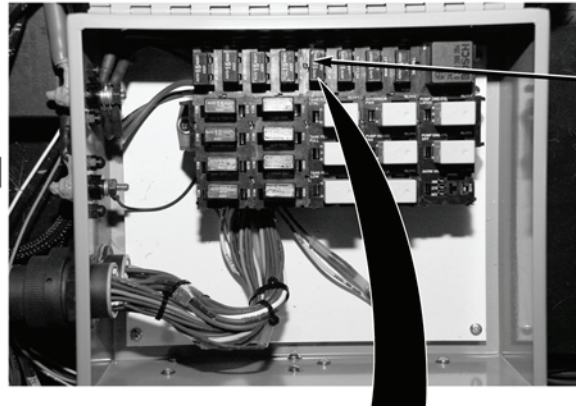

CIRCUIT BREAKER  
P 13

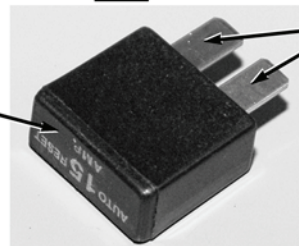

CIRCUIT BREAKER  
P 13

TERMINAL  
CONNECTOR

**WARNING**



Remove rings, wristwatches, neck chains, and any other jewelry before working around vehicle. Jewelry can catch on equipment and cause serious injury. Jewelry and tools may short across electrical circuits and cause damage to equipment, or severe burns or electrical shock to personnel.

- Step 17. Turn battery disconnect switch to OFF position (WP 0007). Remove pump house panel S (WP 0540). Open pump house power distribution (WP 0412). Remove circuit breaker P13 (WP 0412). Check for continuity across circuit breaker.

If there is no continuity, replace circuit breaker P13 (WP 0412).

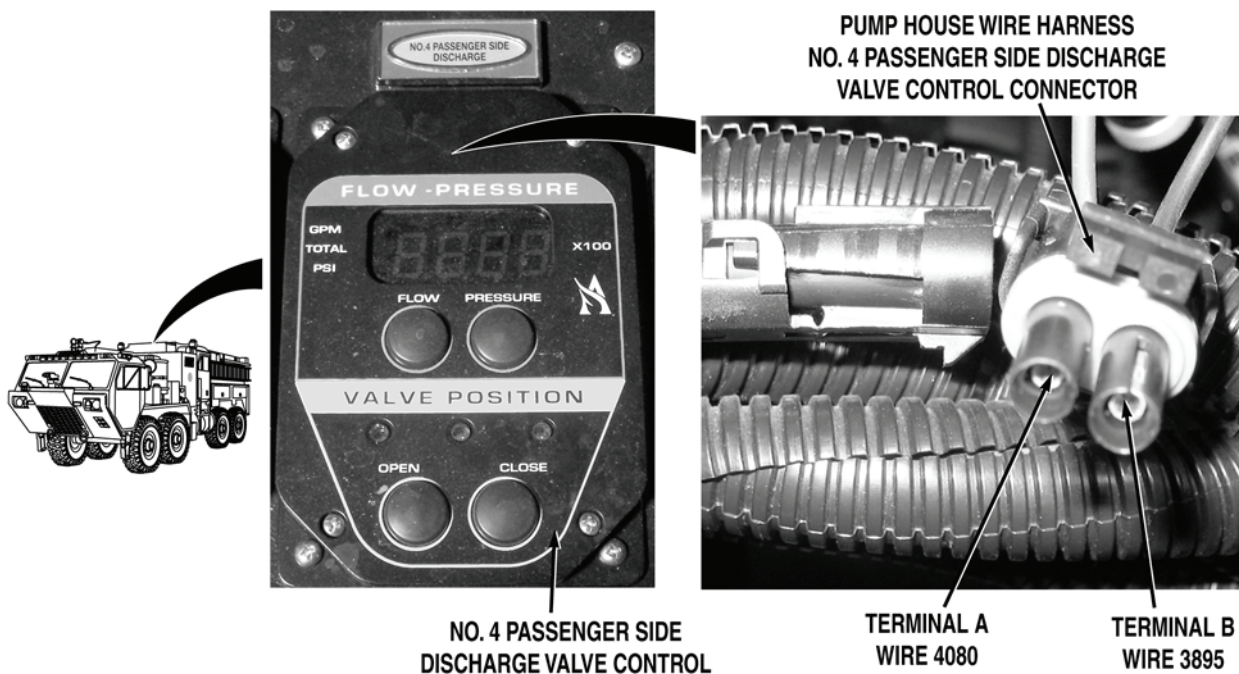
**MALFUNCTION****TEST OR INSPECTION****CORRECTIVE ACTION**

- Step 18. Install circuit breaker P13 (WP 0412). Open pump operator's panel housing (WP 0325). Disconnect pump house wire harness NO. 4 PASSENGER SIDE DISCHARGE valve control connector. Turn battery disconnect switch to ON position (WP 0007). Check for 22 to 28 VDC between pump operator's panel wire harness wire 4080 (violet) at NO. 4 PASSENGER SIDE DISCHARGE valve control connector, terminal A and a known good ground.

If 22 to 28 VDC are not present, go to Step 20.

- Step 19. Turn battery disconnect switch to OFF position (WP 0007). With a test lead set, check for continuity across wire 3895 (black) from pump operator's panel NO. 4 PASSENGER SIDE DISCHARGE valve control connector, terminal B and a known good ground.
- If there is continuity, replace No. 4 PASSENGER SIDE DISCHARGE valve control (WP 0417).
  - If there is no continuity, repair wire 3895 in pump operator's panel wire harness if repairable (TM 9-2320-325-14&P), or replace pump operator's panel wire harness (WP 0459).

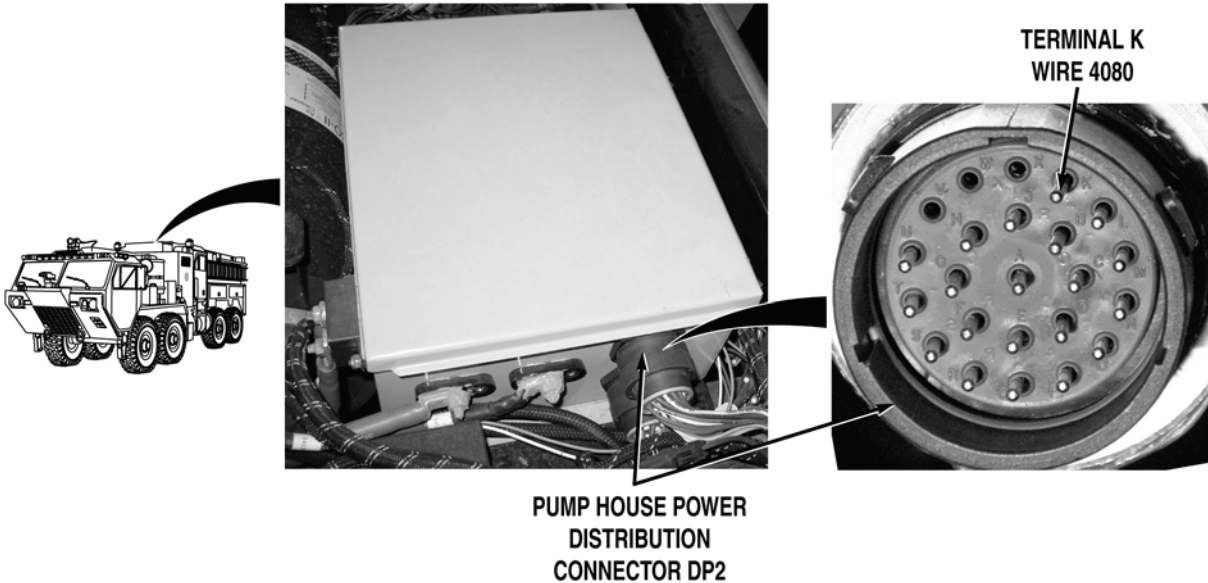
**MALFUNCTION****TEST OR INSPECTION****CORRECTIVE ACTION**

- Step 20. Turn battery disconnect switch to OFF position (WP 0007). Disconnect pump operator's panel wire harness pump house power distribution wire harness connector DP2. Turn battery disconnect switch to ON position (WP 0007). With a test lead set, check for 22 to 28 VDC between pump house power distribution wire harness wire 4080 (violet) at connector DP2, terminal K and a known good ground.
- a. If 22 to 28 VDC are present, repair wire 4080 in pump operator's panel wire harness if repairable (TM 9-2320-325-14&P), or replace pump operator's panel wire harness (WP 0459).
  - b. If 22 to 28 VDC are not present, repair wire 4080 in pump house power distribution wire harness if repairable (TM 9-2320-325-14&P), or replace pump house power distribution wire harness and block (WP 0457).

**END OF TASK****FOLLOW-ON MAINTENANCE**

Remove wheel chocks (TM 9-2320-347-10)

**END OF TASK****END OF WORK PACKAGE**



**FIELD LEVEL MAINTENANCE**

**PASSENGER SIDE AUXILIARY INLET VALVE DOES NOT OPERATE PROPERLY**

**INITIAL SETUP:**

**Tools and Special Tools**

- Lead Set, Test (WP 0622, Item 21)
- Tool Kit, General Mechanic's: Automotive (WP 0622, Item 27)

**References**

- TM 9-2320-325-14&P
- WP 0004
- WP 0007
- WP 0010
- WP 0294
- WP 0325
- WP 0387

**References (continued)**

- WP 0388
- WP 0412
- WP 0418
- WP 0453
- WP 0457
- WP 0459
- WP 0540

**Equipment Conditions**

- Water pump engine OFF (WP 0022)
- Engine OFF (TM 9-2320-347-10)
- Wheels chocked (TM 9-2320-347-10)

**MALFUNCTION**

**TEST OR INSPECTION**

**CORRECTIVE ACTION**

**PASSENGER SIDE AUXILIARY INLET VALVE DOES NOT OPERATE PROPERLY**

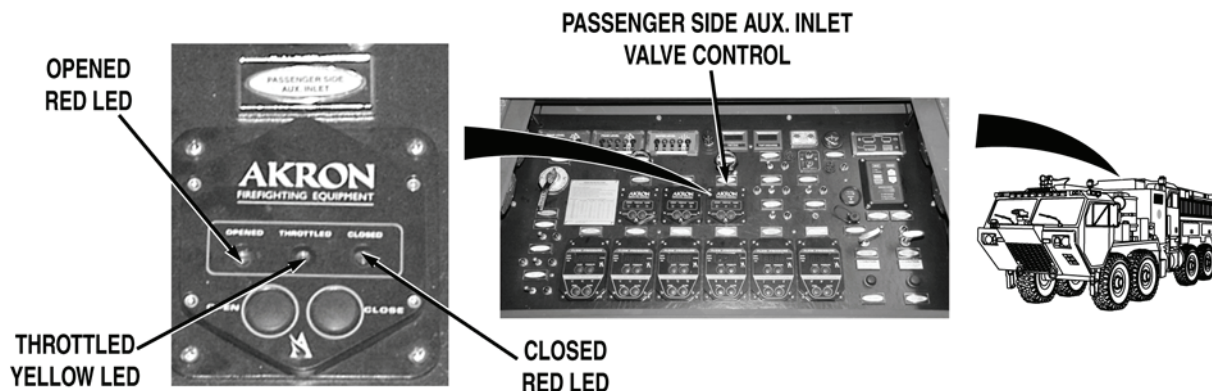

**NOTE**

Ensure batteries are fully charged before performing Step 1.

Step 1. Turn battery disconnect switch to ON position (WP 0007). Check if pump operator's panel PASSENGER SIDE AUX. INLET valve control display illuminates.

If display is not illuminated, go to Step 12.

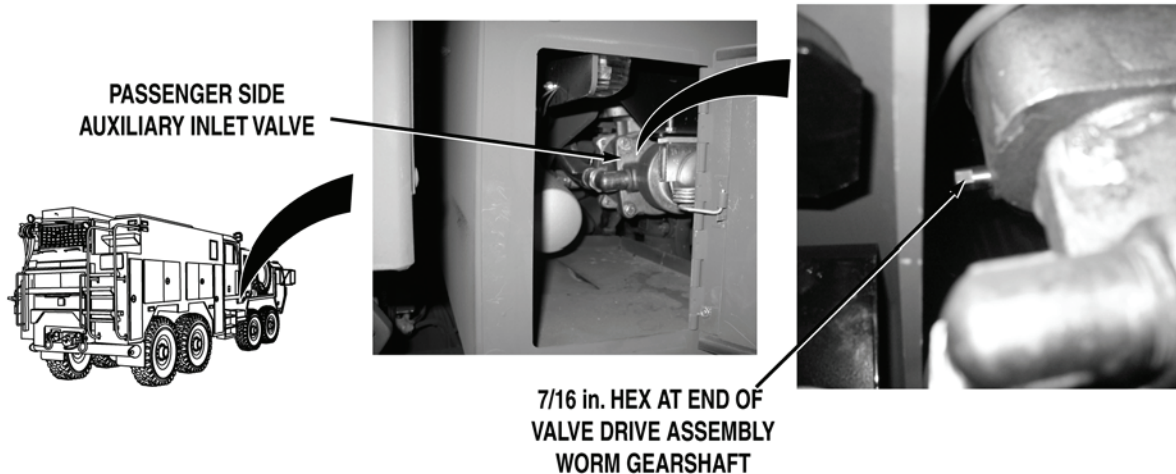
**MALFUNCTION****TEST OR INSPECTION****CORRECTIVE ACTION****NOTE**

- Do not engage water pump engine during this procedure. Valve operations can be checked without water pump operations.
- Valve operation can be checked either by noting vibration of valve assembly, or by observing rotation of 7/16 in. hex at end of valve drive assembly worm gearshaft.
- Do not remove cap from PASSENGER SIDE AUX. INLET. Water may be released from system when valve is operated.

Step 2. Open remote oil filter door (WP 0010). While an assistant pushes pump operator's panel PASSENGER SIDE AUX. INLET valve control OPEN and CLOSE buttons (WP 0004), check if passenger side auxiliary inlet valve operates.

If passenger side auxiliary inlet valve does not open and close, go to Step 6.

**NOTE**

PASSENGER SIDE AUX. INLET valve control will indicate 'THROTTLED' with a yellow LED while valve is partially opened or closed.

Step 3. While an assistant pushes pump operator's panel PASSENGER SIDE AUX. INLET valve control OPEN and CLOSE buttons (WP 0004), check if PASSENGER SIDE AUX. INLET valve control OPENED (green) and CLOSED (red) indicators illuminate before the valve is fully opened or closed.

If PASSENGER SIDE AUX. INLET valve control indicators illuminate before the valve is fully opened or closed, go to Step 8.

---

**MALFUNCTION****TEST OR INSPECTION****CORRECTIVE ACTION**

---

**NOTE**

Valve operations must be checked by observing rotation of 7/16 in. hex at end of valve drive assembly worm gearshaft for Step 4.

- Step 4. While an assistant pushes pump operator's panel PASSENGER SIDE AUX. INLET valve control OPEN and CLOSE buttons (WP 0004), check if passenger side auxiliary inlet valve worm gearshaft moves excessively after valve is fully opened or closed.

If passenger side auxiliary inlet valve worm gearshaft moves excessively after valve is fully opened or closed, remove and re-install passenger side auxiliary inlet valve motor (WP 0388), ensuring all mounting hardware is secure.

- Step 5. Remove passenger side auxiliary inlet valve (WP 0294) and inspect it for damage and contamination.
- a. If passenger side auxiliary inlet valve is free from damage and contamination, reinstall valve (WP 0294) and go to Step 6.
  - b. If passenger side auxiliary inlet valve is damaged and/or contaminated, repair (WP 0387) or replace passenger side auxiliary inlet valve (WP 0294).

**MALFUNCTION**

**TEST OR INSPECTION**

**CORRECTIVE ACTION**

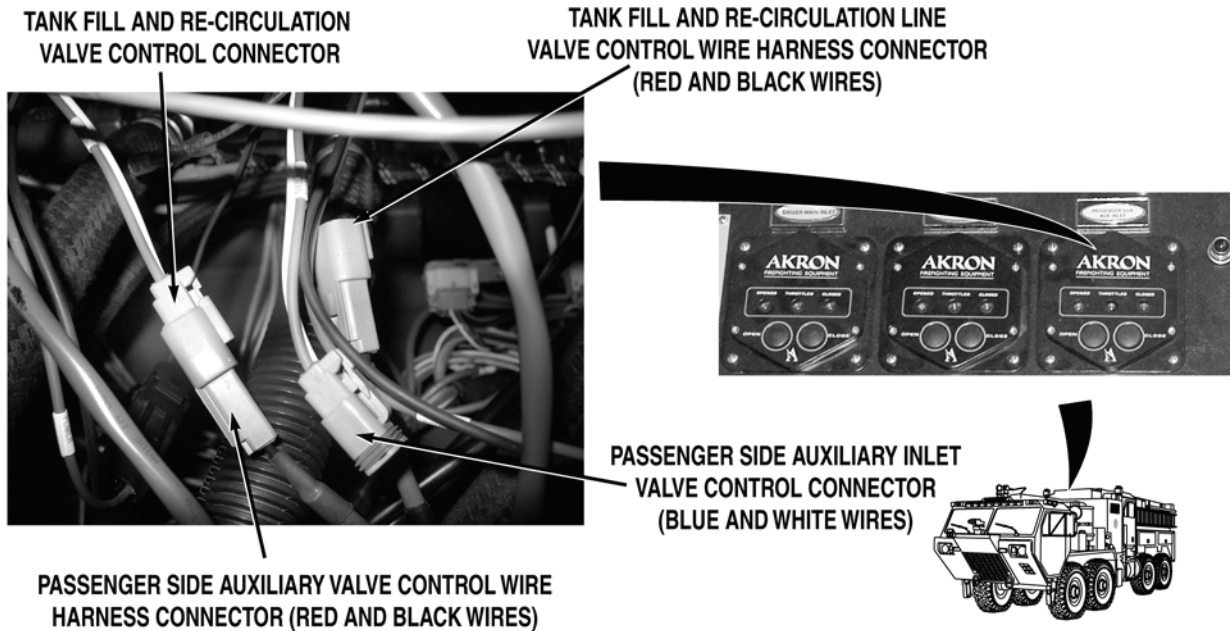

**WARNING**



**Remove rings, wristwatches, neck chains, and any other jewelry before working around vehicle. Jewelry can catch on equipment and cause serious injury. Jewelry and tools may short across electrical circuits and cause damage to equipment, or severe burns or electrical shock to personnel.**

Step 6. Turn battery disconnect switch to OFF position (WP 0007). Open pump operator's panel housing (WP 0325). Disconnect valve control wire harness connector from PASSENGER SIDE AUX. INLET valve control. Disconnect valve control wire harness connector from TANK FILL & RE-CIRCULATING LINE valve control. Connect passenger side auxiliary inlet valve control wire harness connector to TANK FILL & RE-CIRCULATING LINE valve control connector. Turn battery disconnect switch to ON position (WP 0007). While an assistant monitors operation of passenger side auxiliary inlet valve, push pump operator's panel TANK FILL & RE-CIRCULATING LINE valve control OPEN and CLOSE buttons (WP 0004). Check if TANK FILL & RE-CIRCULATING LINE valve control OPENED (green) and CLOSED (red) indicators illuminate before passenger side auxiliary inlet valve is fully opened or closed.

If TANK FILL & RE-CIRCULATING valve control indicators do not illuminate before passenger side auxiliary valve is fully opened or closed, reconnect valve control wire harnesses to original positions and replace PASSENGER SIDE AUX. INLET valve control (WP 0418).

**MALFUNCTION****TEST OR INSPECTION****CORRECTIVE ACTION**

- Step 7. Turn battery disconnect switch to OFF position (WP 0007). Reconnect valve control wire harnesses to original positions. Remove passenger side auxiliary inlet valve (WP 0294) and inspect it for binding, damage, and contamination.
- If passenger side auxiliary inlet valve is free from binding, damage, and contamination, reinstall valve (WP 0294) and replace passenger side auxiliary inlet valve motor and drive assembly (WP 0388).
  - If passenger side auxiliary inlet valve is not free from binding, damage, and/or contamination, repair (WP 0387) or replace passenger side auxiliary inlet valve (WP 0294).

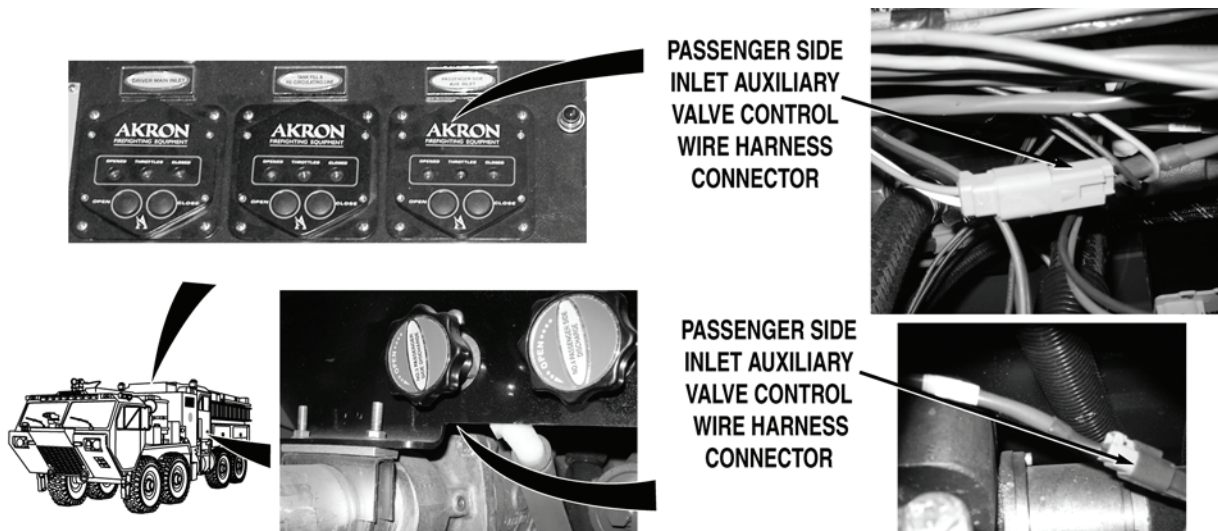
**WARNING**

**Remove rings, wristwatches, neck chains, and any other jewelry before working around vehicle. Jewelry can catch on equipment and cause serious injury. Jewelry and tools may short across electrical circuits and cause damage to equipment, or severe burns or electrical shock to personnel.**

- Step 8. Turn battery disconnect switch to OFF position (WP 0007). Open pump operator's panel housing (WP 0325). Check passenger side auxiliary inlet valve control wire harness from PASSENGER SIDE AUX. INLET valve control to passenger side auxiliary inlet valve motor for loose connections.

If passenger side auxiliary inlet valve control wire harness connectors are loose, reconnect loose passenger side auxiliary inlet valve control wire harness connectors (WP 0453).

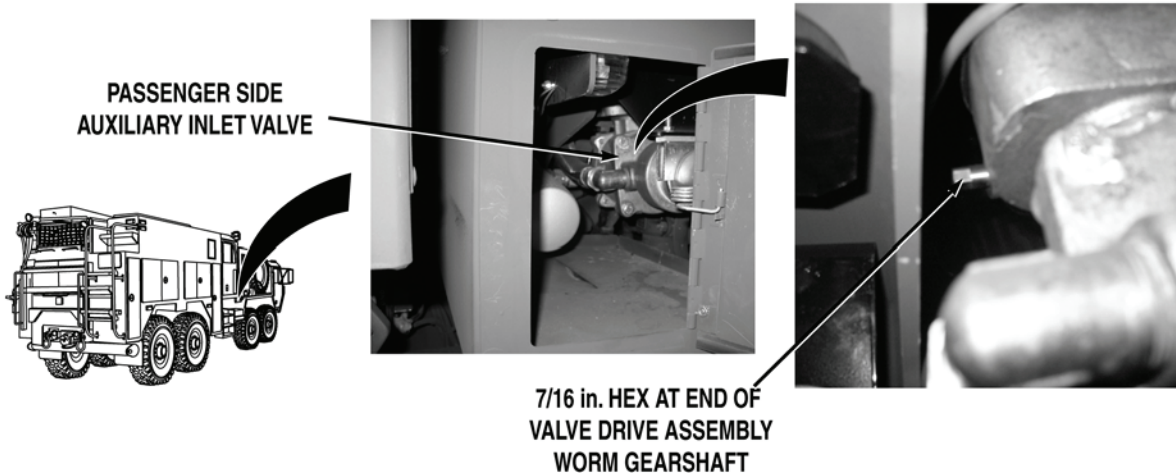
**MALFUNCTION****TEST OR INSPECTION****CORRECTIVE ACTION****NOTE**

- Do not engage water pump engine during this procedure. Valve operations can be checked without water pump operations.
- Valve motor operation can be checked either by noting vibration of valve assembly, or by observing rotation of 7/16 in. hex at end of valve drive assembly worm gearshaft.
- Do not remove cap from PASSENGER SIDE AUX. INLET. Water may be released from the system when valve is operated.

Step 9. Turn battery disconnect switch to ON position (WP 0007). While an assistant pushes pump operator's panel PASSENGER SIDE AUX. INLET valve control OPEN and CLOSE buttons (WP 0004), check if PASSENGER SIDE AUX. INLET valve control THROTTLED (yellow) indicator illuminates and passenger side auxiliary inlet valve motor operates.

If indicator illuminates and valve motor operates, replace passenger side auxiliary inlet valve drive assembly (WP 0388).

**MALFUNCTION**  
**TEST OR INSPECTION**  
**CORRECTIVE ACTION**

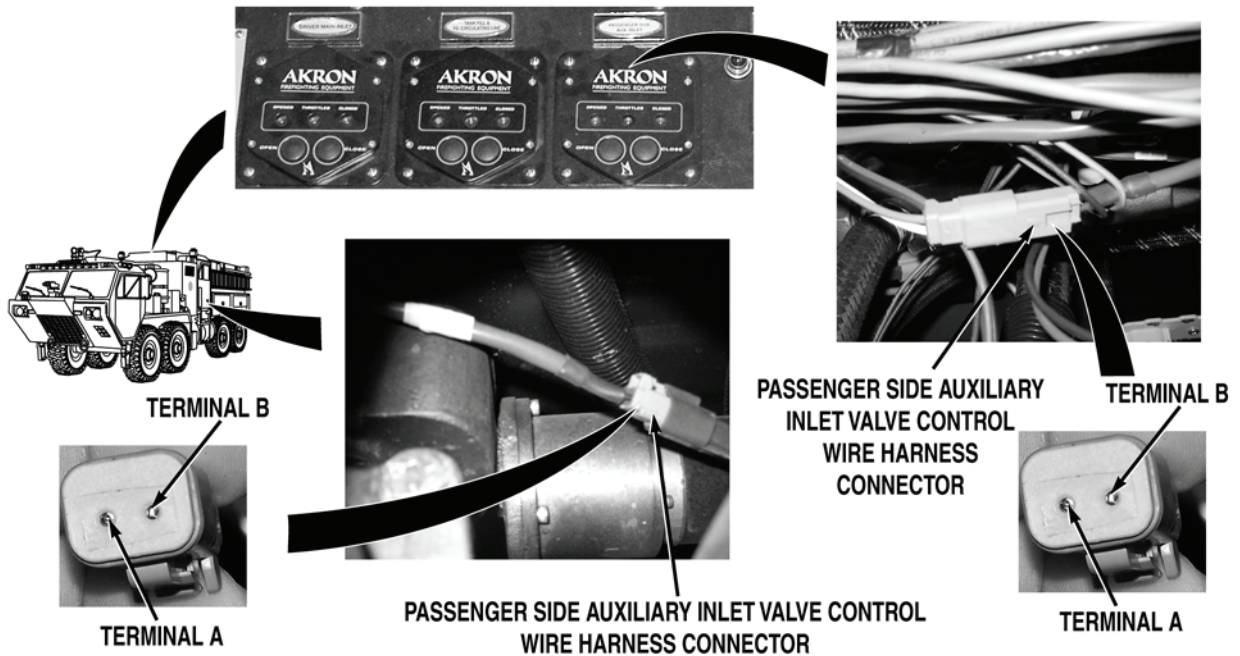

**WARNING**



**Remove rings, wristwatches, neck chains, and any other jewelry before working around vehicle. Jewelry can catch on equipment and cause serious injury. Jewelry and tools may short across electrical circuits and cause damage to equipment, or severe burns or electrical shock to personnel.**

- Step 10. Turn battery disconnect switch to OFF position (WP 0007). Disconnect valve control wire harness connectors from PASSENGER SIDE AUX. INLET valve control and passenger side auxiliary inlet valve motor. With a test lead set, check for continuity across passenger side auxiliary inlet valve control wire harness valve control to passenger side auxiliary inlet valve motor connector, terminal to terminal.

If there is no continuity, repair wires if repairable (TM 9-2320-325-14&P), or replace passenger side auxiliary inlet valve control wire harness (WP 0453).

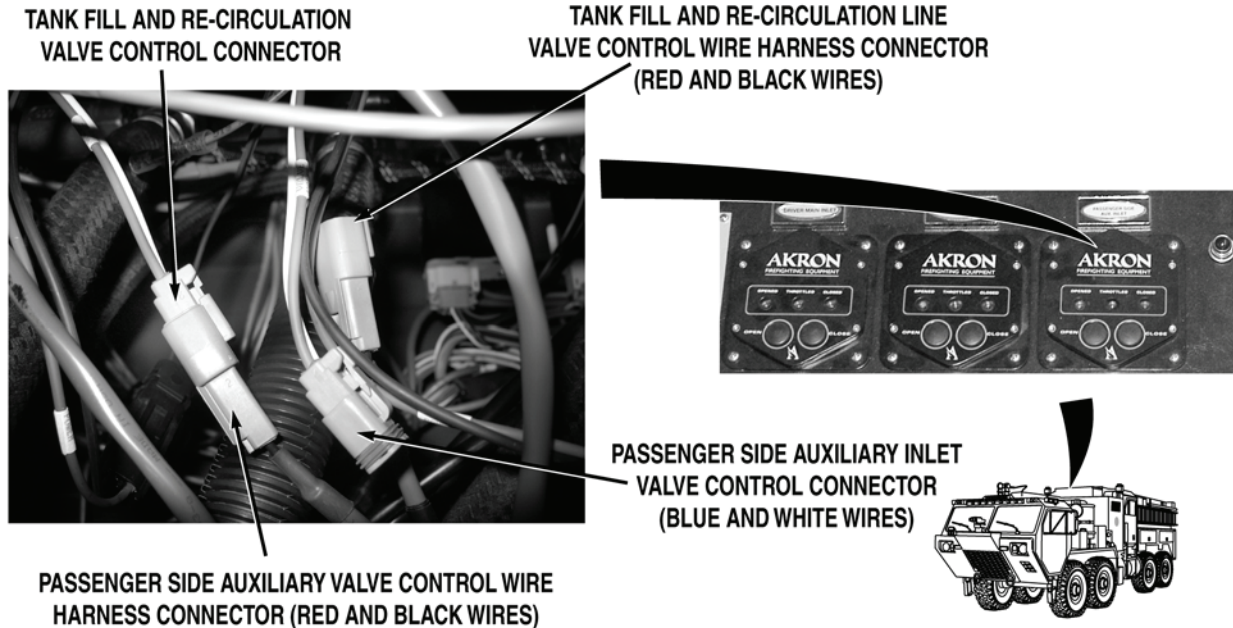
**MALFUNCTION****TEST OR INSPECTION****CORRECTIVE ACTION**

- Step 11. Connect passenger side auxiliary inlet valve control wire harness connector to passenger side auxiliary inlet valve motor. Disconnect driver side auxiliary inlet valve control wire harness connector from TANK FILL & RE-CIRCULATING LINE valve control. Connect passenger side auxiliary inlet valve control wire harness connector to TANK FILL & RE-CIRCULATING LINE valve control connector. Push battery disconnect switch to ON position (WP 0007). While an assistant pushes pump operator's panel TANK FILL & RE-CIRCULATING LINE valve control OPEN and CLOSE buttons (WP 0004), check if passenger side auxiliary inlet valve operates.
- a. If passenger side auxiliary inlet valve operates, reconnect valve control wire harness connectors to original positions and replace PASSENGER SIDE AUX. INLET valve control (WP 0418).
  - b. If passenger side auxiliary inlet valve does not operate, reconnect valve control wire harness connectors to original positions and replace passenger side auxiliary inlet valve motor (WP 0388).

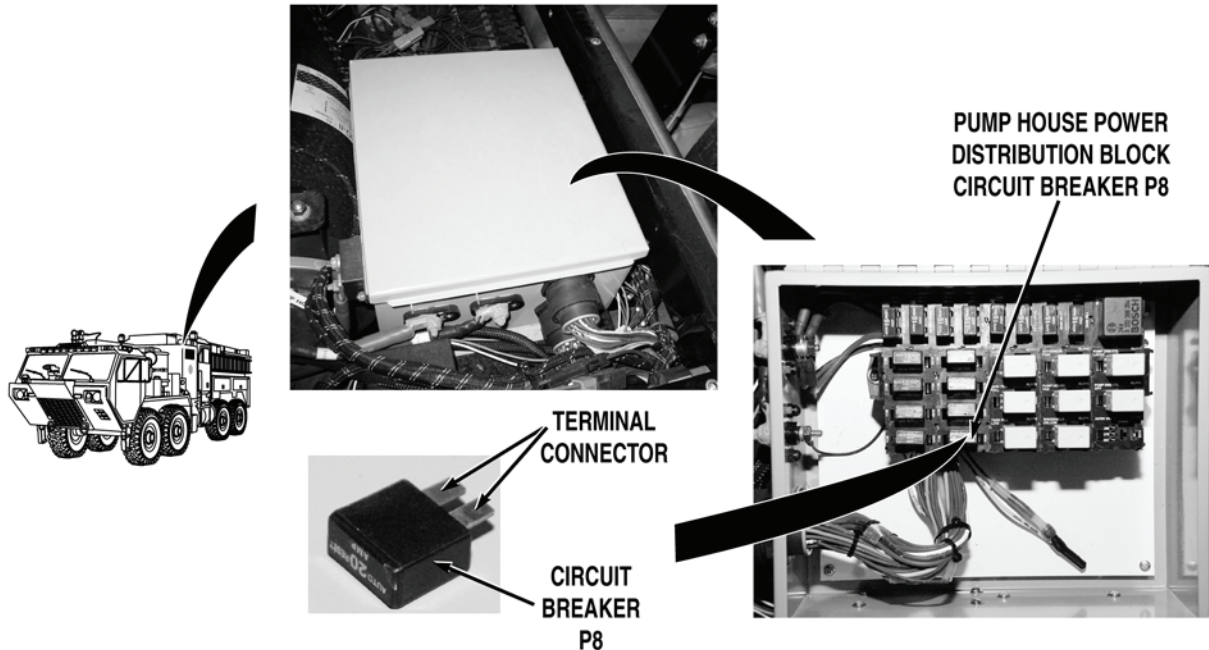

**MALFUNCTION****TEST OR INSPECTION****CORRECTIVE ACTION****WARNING**

**Remove rings, wristwatches, neck chains, and any other jewelry before working around vehicle. Jewelry can catch on equipment and cause serious injury. Jewelry and tools may short across electrical circuits and cause damage to equipment, or severe burns or electrical shock to personnel.**

- Step 12. Turn battery disconnect switch to OFF position (WP 0007). Remove pump house panel S (WP 0540). Open pump house power distribution (WP 0412). Remove circuit breaker P8 (WP 0412). Check for continuity across circuit breaker.

If there is no continuity, replace circuit breaker P8 (WP 0412).

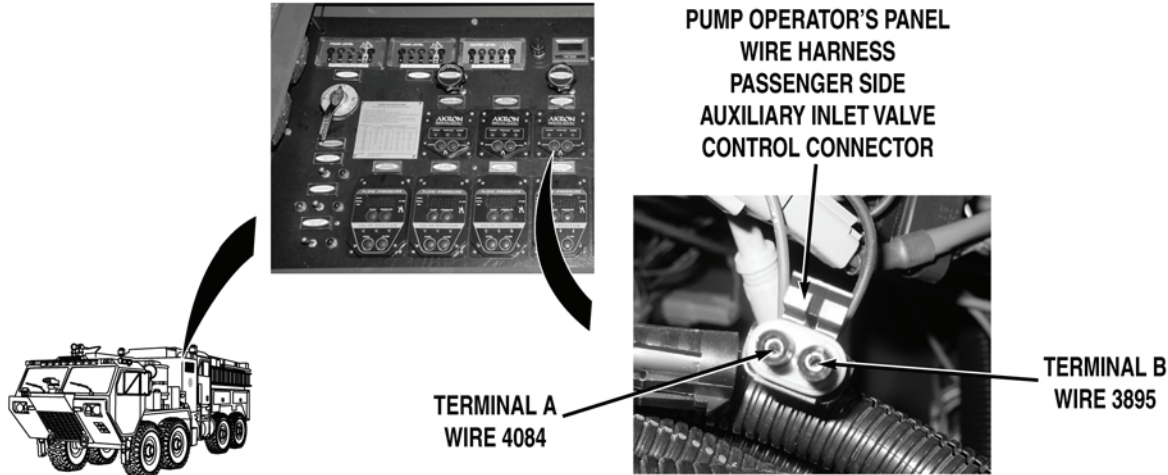
**MALFUNCTION****TEST OR INSPECTION****CORRECTIVE ACTION**

- Step 13. Install circuit breaker P8 (WP 0412). Open pump operator's panel housing (WP 0325). Disconnect pump operator's panel wire harness PASSENGER SIDE AUX. INLET valve control connector. Turn battery disconnect switch to ON position (WP 0007). With a test lead set, check for 22 to 28 VDC between pump operator's panel wire harness wire 4084 (white) at PASSENGER SIDE AUX. INLET valve control connector, terminal A and a known good ground.

If 22 to 28 VDC are not present, go to Step 15.

- Step 14. Turn battery disconnect switch to OFF position (WP 0007). With a test lead set, check for continuity across wire 3895 (black) from pump operator's panel wire harness PASSENGER SIDE AUX. INLET valve control connector, terminal B to a known good ground.
- a. If there is continuity, replace PASSENGER SIDE AUX. INLET valve control (WP 0418).
  - b. If there is no continuity, repair wire 3895 in pump operator's panel wire harness if repairable (TM 9-2320-325-14&P), or replace pump operator's panel wire harness (WP 0459).

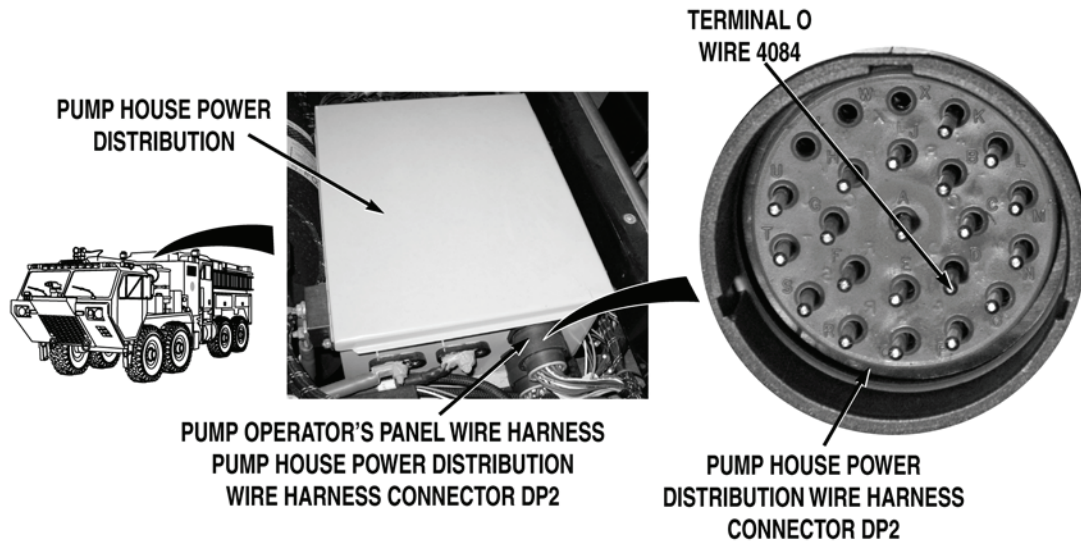
**MALFUNCTION****TEST OR INSPECTION****CORRECTIVE ACTION**

- Step 15. Turn battery disconnect switch to OFF position (WP 0007). Disconnect pump operator's panel wire harness pump house power distribution wire harness connector DP2. Turn battery disconnect switch to ON position (WP 0007). With a test lead set, check for 22 to 28 VDC between pump house power distribution wire harness wire 4084 (white) at connector DP2, terminal O and a known good ground.
- a. If 22 to 28 VDC are present, repair wire 4084 in pump operator's panel wire harness if repairable (TM 9-2320-325-14&P), or replace pump operator's panel wire harness (WP 0459).
  - b. If 22 to 28 VDC are not present, repair wire 4084 in power distribution wire harness if repairable (TM 9-2320-325-14&P), or replace power distribution wire harness and block (WP 0457).

**END OF TASK****FOLLOW-ON MAINTENANCE**

Remove wheel chocks (TM 9-2320-347-10)

**END OF TASK****END OF WORK PACKAGE**



**FIELD LEVEL MAINTENANCE**

**PUMP COOLER VALVE DOES NOT OPERATE PROPERLY**

**INITIAL SETUP:**

**Tools and Special Tools**

Lead Set, Test (WP 0622, Item 21)  
 Tool Kit, General Mechanic's: Automotive  
 (WP 0622, Item 27)

**Personnel Required**

MOS 63B Wheeled vehicle mechanic (2)

**References**

TM 9-2320-325-14&P  
 WP 0004  
 WP 0007  
 WP 0311  
 WP 0315  
 WP 0337  
 WP 0339  
 WP 0370  
 WP 0398

**References (continued)**

WP 0402  
 WP 0440  
 WP 0441  
 WP 0442  
 WP 0443  
 WP 0455  
 WP 0459  
 WP 0499  
 WP 0540  
 WP 0550  
 WP 0567  
 WP 0578

**Equipment Conditions**

Water pump engine OFF (WP 0022)  
 Engine OFF (TM 9-2320-347-10)  
 Wheels chocked (TM 9-2320-347-10)

**MALFUNCTION**

**TEST OR INSPECTION**

**CORRECTIVE ACTION**

**PUMP COOLER VALVE DOES NOT OPERATE PROPERLY**

**NOTE**

- Ensure system air pressure is at least 85 psi (586 kPa) during this procedure. System air pressure is required to activate valves.
- Do not engage water pump engine during this procedure, except when performing complete system checks. Valve operations can be checked without water pump operation.
- Valve operations can be checked by observing valve shaft rotation.

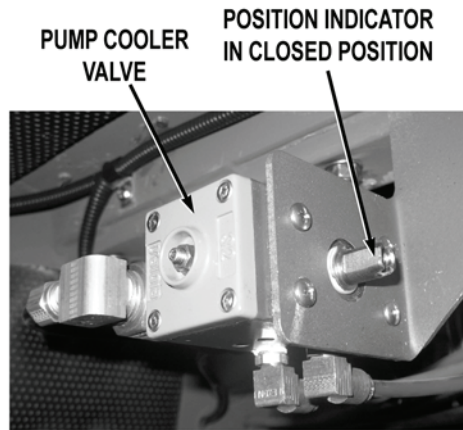
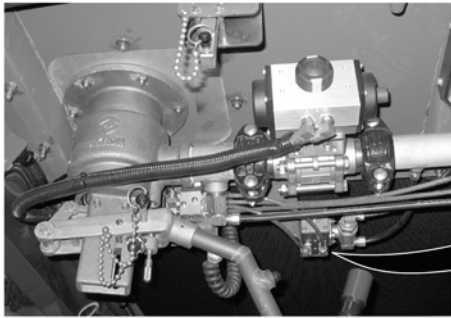
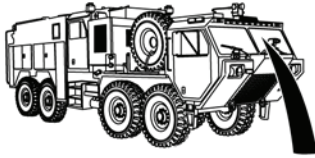
**MALFUNCTION****TEST OR INSPECTION****CORRECTIVE ACTION**

Step 1. Turn battery disconnect switch to ON position (WP 0007). If system air pressure is below 85 psi (586 kPa), start engine and allow system air pressure to build to at least 85 psi (586 kPa) (TM 9-2320-347-10). Then shut off engine (TM 9-2320-347-10). While an assistant puts pump operator's panel PUMP COOLER switch to ON position (WP 0004), check if pump cooler valve operates to open position.

If pump cooler valve does not operate to open position, go to Step 27.

Step 2. Check if pump cooler valve remains in open position, when assistant releases pump operator's panel PUMP COOLER switch (WP 0004).

If pump cooler valve does not remain in open position, go to Step 18.

Step 3. While an assistant puts pump operator's panel PUMP COOLER switch to OFF position (WP 0004), check if pump cooler valve operates to closed position.

If pump cooler valve does not operate to closed position, go to Step 12.

Step 4. Put cab PUMP COOLER switch to on position (WP 0004). Check if pump cooler valve operates to open position.

If pump cooler valve does not operate to open position, go to Step 8.

Step 5. Put cab PUMP COOLER switch to off position (WP 0004). Check if pump cooler valve operates to closed position.

If pump cooler valve operates to closed position, pump cooler valve control is operating correctly.

**MALFUNCTION**  
**TEST OR INSPECTION**  
**CORRECTIVE ACTION**

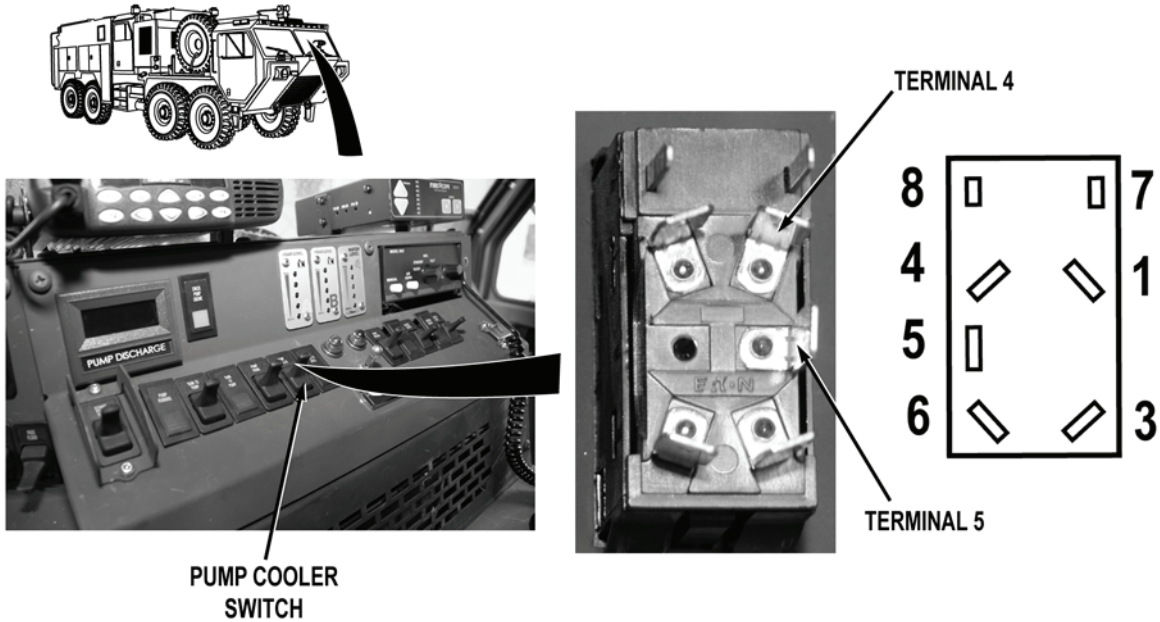

**WARNING**



Remove rings, wristwatches, neck chains, and any other jewelry before working around vehicle. Jewelry can catch on equipment and cause serious injury. Jewelry and tools may short across electrical circuits and cause damage to equipment, or severe burns or electrical shock to personnel.

- Step 6. Turn battery disconnect switch to OFF position (WP 0007). Remove cab instrument panel B (WP 0311). Disconnect cab pump control wire harness PUMP COOLER switch connector. While an assistant holds switch in off position, check for continuity across PUMP COOLER switch, from terminal 5 to terminal 4.

If there is no continuity, replace cab PUMP COOLER switch (WP 0315).

**MALFUNCTION**

**TEST OR INSPECTION**

**CORRECTIVE ACTION**



- Step 7. Disconnect cab pump control wire harness cab power distribution wire harness connector. With a test lead set, check for continuity across cab pump control wire harness wire 4038 (brown) from PUMP COOLER switch connector, terminal 4 to cab pump control wire harness connector, terminal 16.
- a. If there is continuity, repair wire 4038 in cab power distribution wire harness if repairable (TM 9-2320-325-14&P), or replace cab power distribution wire harness and block (WP 0441).
  - b. If there is no continuity, repair wire 4038 in cab pump control wire harness if repairable (TM 9-2320-325-14&P), or replace cab pump control wire harness (WP 0443).



**MALFUNCTION**  
**TEST OR INSPECTION**  
**CORRECTIVE ACTION**

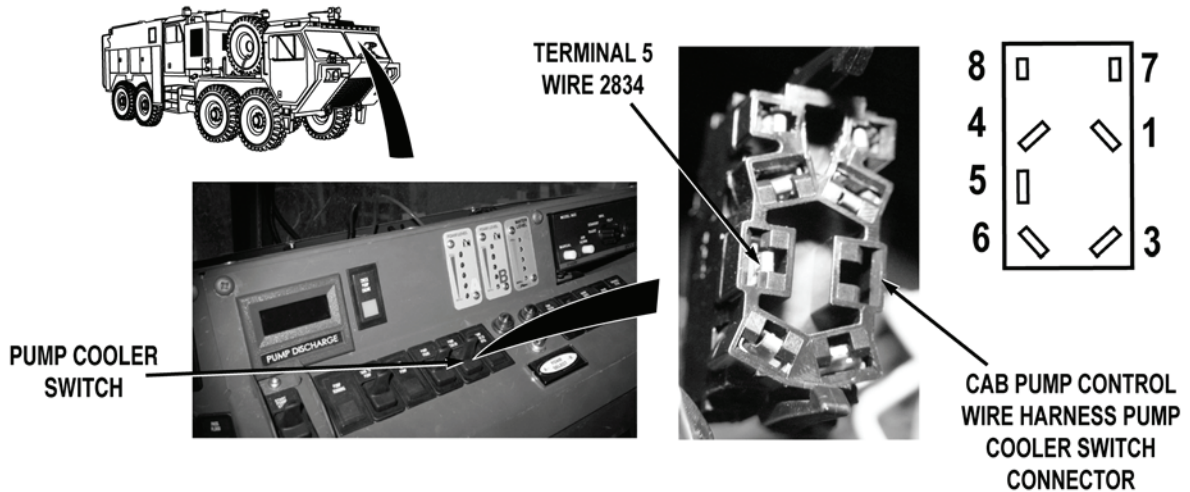

**WARNING**



**Remove rings, wristwatches, neck chains, and any other jewelry before working around vehicle. Jewelry can catch on equipment and cause serious injury. Jewelry and tools may short across electrical circuits and cause damage to equipment, or severe burns or electrical shock to personnel.**

- Step 8. Turn battery disconnect switch to OFF position (WP 0007). Release PUMP COOLER switch (WP 0004). Remove cab instrument panel B (WP 0311). Disconnect cab pump control wire harness PUMP COOLER switch connector. Turn battery disconnect switch to ON position (WP 0007). Check for 22 to 28 VDC between cab pump control wire harness wire 2834 (red) at PUMP COOLER switch connector, terminal 5 and a known good ground.

If 22 to 28 VDC are not present, go to Step 11.

**MALFUNCTION**

**TEST OR INSPECTION**

**CORRECTIVE ACTION**

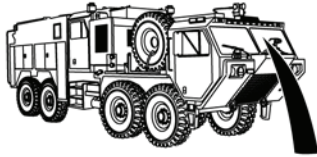

**PUMP COOLER SWITCH**

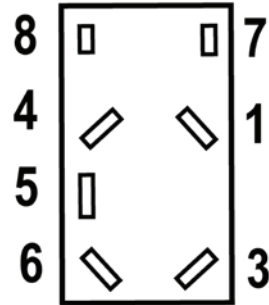
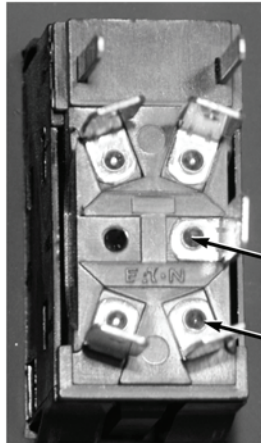

**TERMINAL 5**

**TERMINAL 6**

Step 9. Turn battery disconnect switch to OFF position (WP 0007). While an assistant holds switch in on position, check for continuity across PUMP COOLER switch, from terminal 5 to terminal 6.

If there no continuity, replace cab PUMP COOLER switch (WP 0315).

**MALFUNCTION**

**TEST OR INSPECTION**

**CORRECTIVE ACTION**

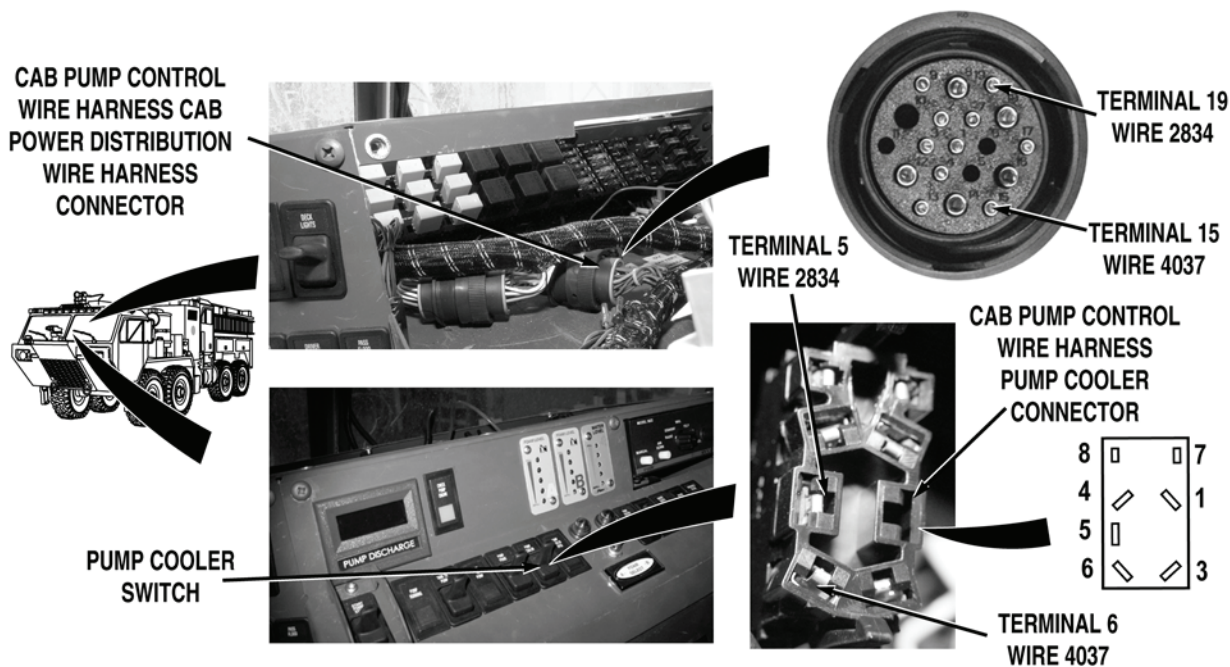

- Step 10. Disconnect cab pump control wire harness cab power distribution wire harness connector. With a test lead set, check for continuity across cab pump control wire harness wire 4037 (orange) from PUMP COOLER switch connector, terminal 6 to cab pump control wire harness connector, terminal 15.
- a. If there is continuity, repair wire 4037 in cab power distribution wire harness if repairable (TM 9-2320-325-14&P), or replace cab power distribution wire harness and block (WP 0441).
  - b. If there is no continuity, repair wire 4037 in cab pump control wire harness if repairable (TM 9-2320-325-14&P), or replace cab pump control wire harness (WP 0443).
- Step 11. Turn battery disconnect switch to OFF position (WP 0007). Disconnect cab pump control wire harness cab power distribution wire harness connector. With a test lead set, check for continuity across cab pump control wire harness wire 2834 (red) from PUMP COOLER switch connector, terminal 5 to cab pump control wire harness connector, terminal 19.
- a. If there is continuity, repair wire 2834 in cab power distribution wire harness if repairable (TM 9-2320-325-14&P), or replace cab power distribution wire harness and block (WP 0441).
  - b. If there is no continuity, repair wire 2834 in cab pump control wire harness if repairable (TM 9-2320-325-14&P), or replace cab pump control wire harness (WP 0443).

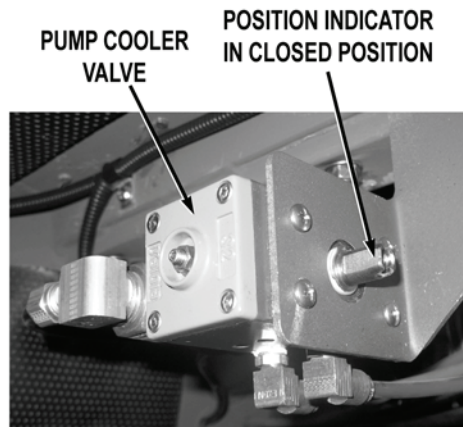
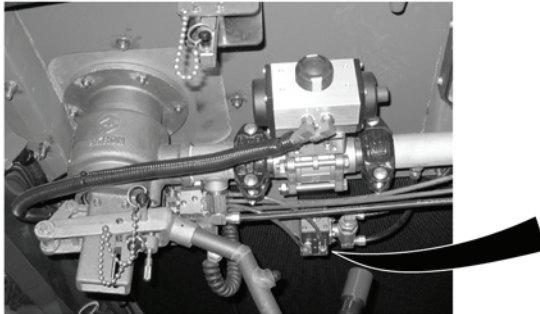
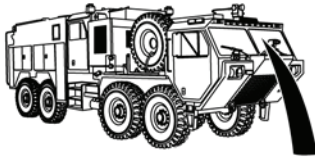
**MALFUNCTION****TEST OR INSPECTION****CORRECTIVE ACTION****NOTE**

- Ensure system air pressure is at least 85 psi (586 kPa) during this procedure. System air pressure is required to activate valves.
- Do not engage water pump engine during this procedure, except when performing complete system checks. Valve operations can be checked without water pump operation.
- Valve operations can be checked by observing valve shaft rotation.

Step 12. Release pump operator's panel PUMP COOLER switch (WP 0004). Put cab PUMP COOLER switch to off position (WP 0004), check if pump cooler valve operates to closed position.

If pump cooler valve does not operate to closed position, go to Step 16.

---

<b>MALFUNCTION</b>	
<b>TEST OR INSPECTION</b>	
<b>CORRECTIVE ACTION</b>	

---

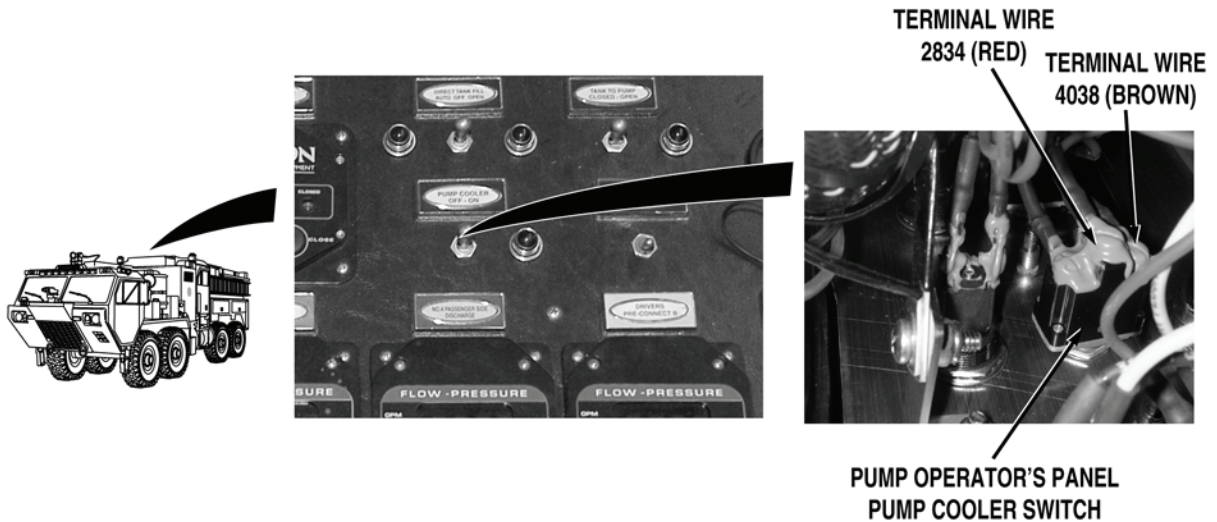
**WARNING**

Remove rings, wristwatches, neck chains, and any other jewelry before working around vehicle. Jewelry can catch on equipment and cause serious injury. Jewelry and tools may short across electrical circuits and cause damage to equipment, or severe burns or electrical shock to personnel.

- Step 13. Release PUMP COOLER switch (WP 0004). Turn battery disconnect switch to OFF position (WP 0007). Open pump operator's panel housing (WP 0325). Check for continuity across pump operator's panel PUMP COOLER switch, from terminal wire 2834 (red) to terminal wire 4038 (brown), while an assistant puts and holds switch in ON position.

If there is no continuity, replace pump operator's panel PUMP COOLER switch (WP 0339).

**MALFUNCTION**

**TEST OR INSPECTION**

**CORRECTIVE ACTION**

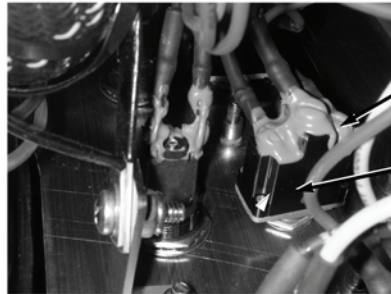
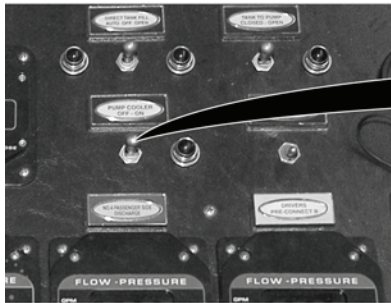

TERMINAL  
WIRE 4038

PUMP OPERATOR'S  
PANEL PUMP  
COOLER SWITCH

CONNECTOR LOCATIONS  
ARE AS FOLLOWS

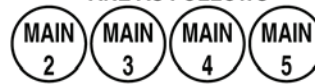

← FRONT OF VEHICLE



MAIN WIRE HARNESS  
MAIN 2 CONNECTOR

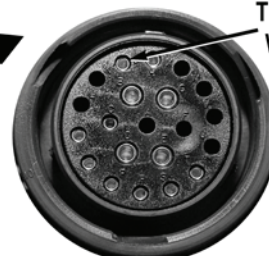

TERMINAL J  
WIRE 4038

- Step 14. Remove skid plate grille (WP 0550). Disconnect main wire harness main 2 connector. With a test lead set, check for continuity across wire 4038 (brown) from pump operator's panel PUMP COOLER switch, terminal to main wire harness main 2 connector, terminal J.

If there is continuity, repair wire 4038 in cab power distribution wire harness if repairable (TM 9-2320-325-14&P), or replace cab power distribution wire harness and block (WP 0441).

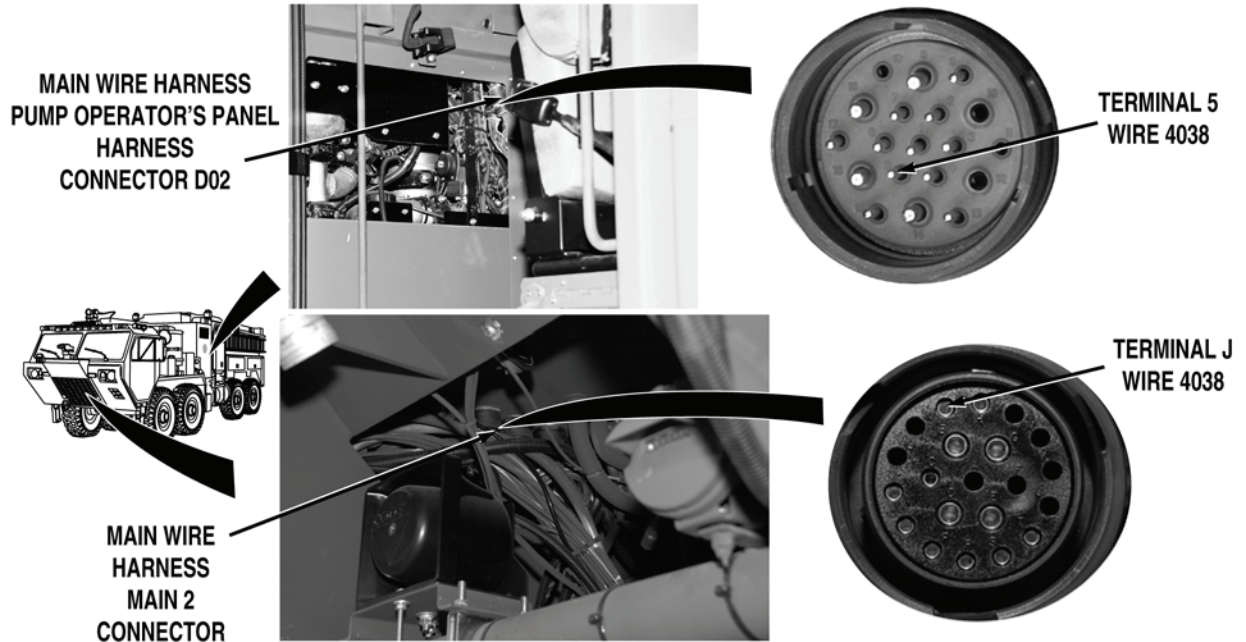
**MALFUNCTION****TEST OR INSPECTION****CORRECTIVE ACTION**

- Step 15. Remove driver side crew cab panel (WP 0499). Remove pump house panel Q (WP 0540). Disconnect main wire harness pump operator's panel wire harness connector D02. With a test lead set, check for continuity across main wire harness wire 4038 (brown) from main wire harness pump operator's panel wire harness connector D02, terminal 5 to main 2 connector, terminal J.
- a. If there is continuity, repair wire 4038 in pump operator's panel wire harness if repairable (TM 9-2320-325-14&P), or replace pump operator's panel wire harness (WP 0459).
  - b. If there is no continuity, repair wire 4038 in main wire harness if repairable (TM 9-2320-325-14&P), or replace main wire harness (WP 0455).

## MALFUNCTION

## TEST OR INSPECTION

## CORRECTIVE ACTION

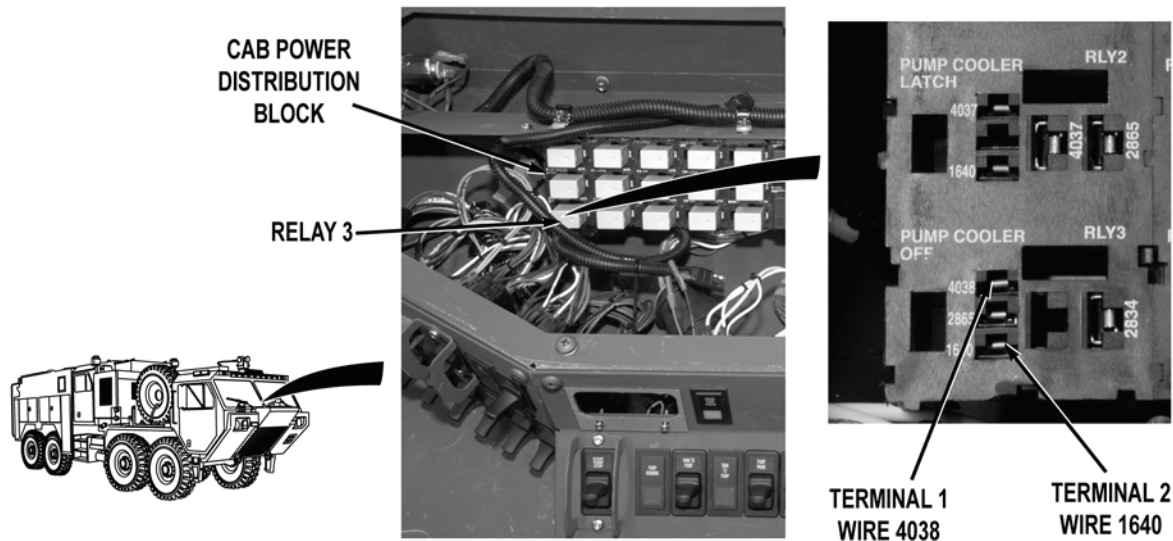
**WARNING**

Remove rings, wristwatches, neck chains, and any other jewelry before working around vehicle. Jewelry can catch on equipment and cause serious injury. Jewelry and tools may short across electrical circuits and cause damage to equipment, or severe burns or electrical shock to personnel.

- Step 16. Release PUMP COOLER switch (WP 0004). Remove cab instrument panel A (WP 0311). Remove relay 3 (WP 0402). While an assistant holds cab PUMP COOLER switch to off position (WP 0004), check for 22 to 28 VDC between cab power distribution wire harness wire 4038 (brown) at relay 3 connector, terminal 1 and a known good ground.

If 22 to 28 VDC are not present, repair wire 4038 in cab power distribution wire harness if repairable (TM 9-2320-325-14&P), or replace cab power distribution wire harness and block (WP 0441).

- Step 17. Turn battery disconnect switch to OFF position (WP 0007). Check for continuity across cab power distribution wire harness wire 1640 (black) from relay 3 connector, terminal 2 to a known good ground.
- If there is continuity, replace relay 3 (WP 0402).
  - If there is no continuity, replace cab power distribution wire harness and block (WP 0441).



---

**MALFUNCTION****TEST OR INSPECTION****CORRECTIVE ACTION**

---

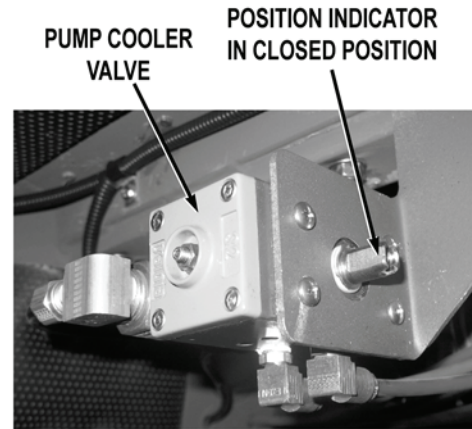
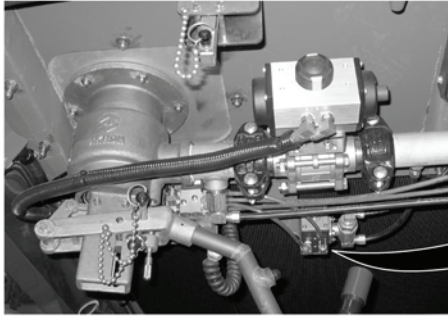
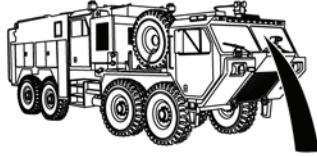

Step 18. Put cab PUMP COOLER switch to on position (WP 0004), check if pump cooler valve operates to open position.

If pump cooler valve does operate to open position, go to Step 26.

## MALFUNCTION

## TEST OR INSPECTION

## CORRECTIVE ACTION

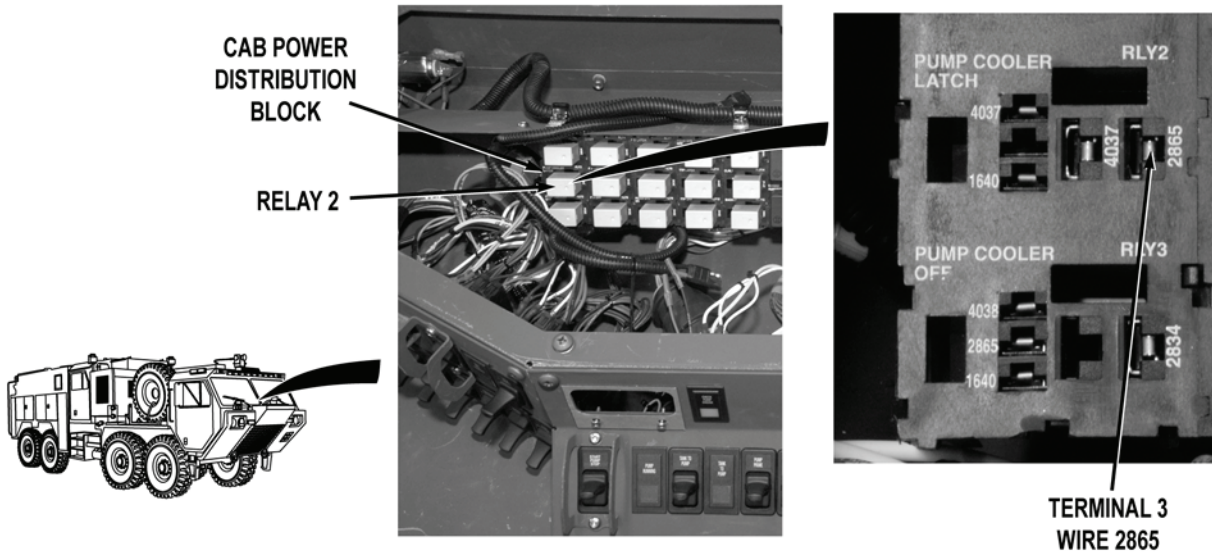
**WARNING**

Remove rings, wristwatches, neck chains, and any other jewelry before working around vehicle. Jewelry can catch on equipment and cause serious injury. Jewelry and tools may short across electrical circuits and cause damage to equipment, or severe burns or electrical shock to personnel.

- Step 19. Turn battery disconnect switch to OFF position (WP 0007). Put cab PUMP COOLER switch to off position (WP 0004). Remove cab instrument panel A (WP 0311). Remove relay 2 (WP 0402). Turn battery disconnect switch to ON position (WP 0007). Check for 22 to 28 VDC between cab power distribution wire harness wire 2865 (gray) at relay 2 connector, terminal 3 and a known good ground.

If 22 to 28 VDC are not present, go to Step 24.

**MALFUNCTION**  
**TEST OR INSPECTION**  
**CORRECTIVE ACTION**

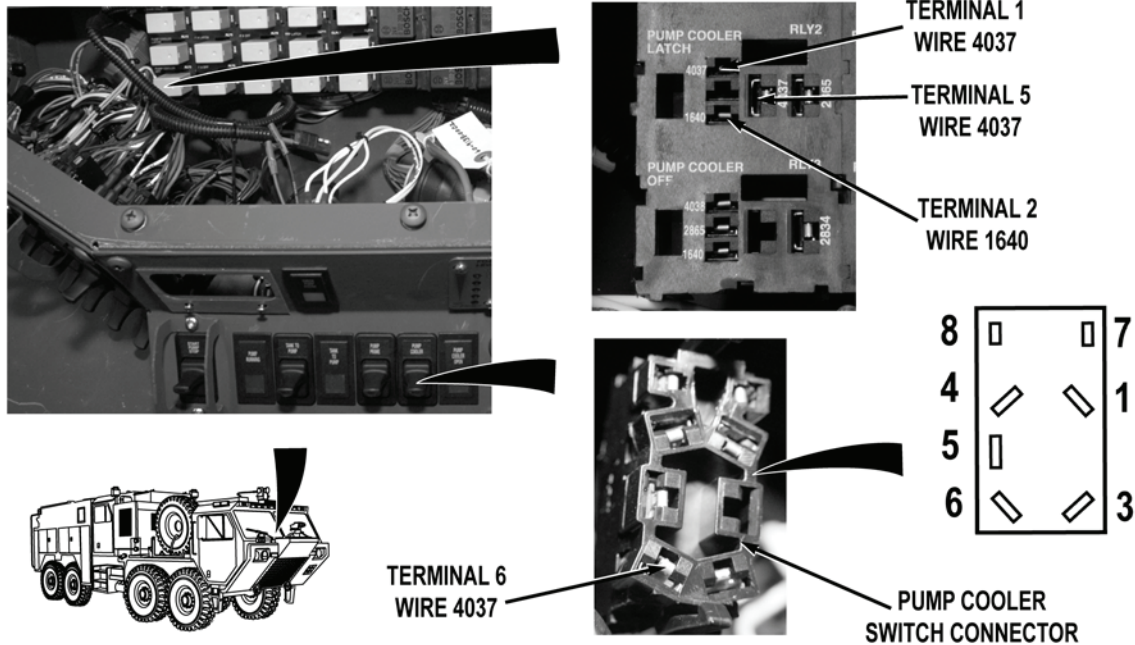

Step 20. Turn battery disconnect switch to OFF position (WP 0007). Disconnect cab pump control wire harness PUMP COOLER switch connector. Check for continuity across wire 4037 (orange) from cab pump control wire harness PUMP COOLER switch connector, terminal 6 to cab power distribution wire harness relay 2 connector, terminal 1.

If there is no continuity, go to Step 23.

Step 21. Check for continuity across cab power distribution wire harness wire 1640 (black) from relay 2 connector, terminal 2 to a known good ground.

If there is no continuity, replace cab power distribution wire harness and block (WP 0441).

Step 22. Check for continuity across cab power distribution wire harness wire 4037 (orange) from relay 2 connector, terminal 1 to relay 2 connector, terminal 5.

- a. If there is continuity, replace relay 2 (WP 0402).
- b. If there is no continuity, replace cab power distribution wire harness and block (WP 0441).

**MALFUNCTION**

**TEST OR INSPECTION**

**CORRECTIVE ACTION**



**WARNING**



**Remove rings, wristwatches, neck chains, and any other jewelry before working around vehicle. Jewelry can catch on equipment and cause serious injury. Jewelry and tools may short across electrical circuits and cause damage to equipment, or severe burns or electrical shock to personnel.**

- Step 23. Disconnect cab pump control wire harness cab power distribution wire harness connector. With a test lead set, check for continuity across cab pump control wire harness wire 4037 (orange) from PUMP COOLER switch connector, terminal 6 to cab pump control wire harness connector, terminal 15.
- a. If there is continuity, repair wire 4037 in cab power distribution wire harness if repairable (TM 9-2320-325-14&P), or replace cab power distribution wire harness and block (WP 0441).
  - b. If there is no continuity, repair wire 4037 in cab pump control wire harness if repairable (TM 9-2320-325-14&P), or replace cab pump control wire harness (WP 0443).

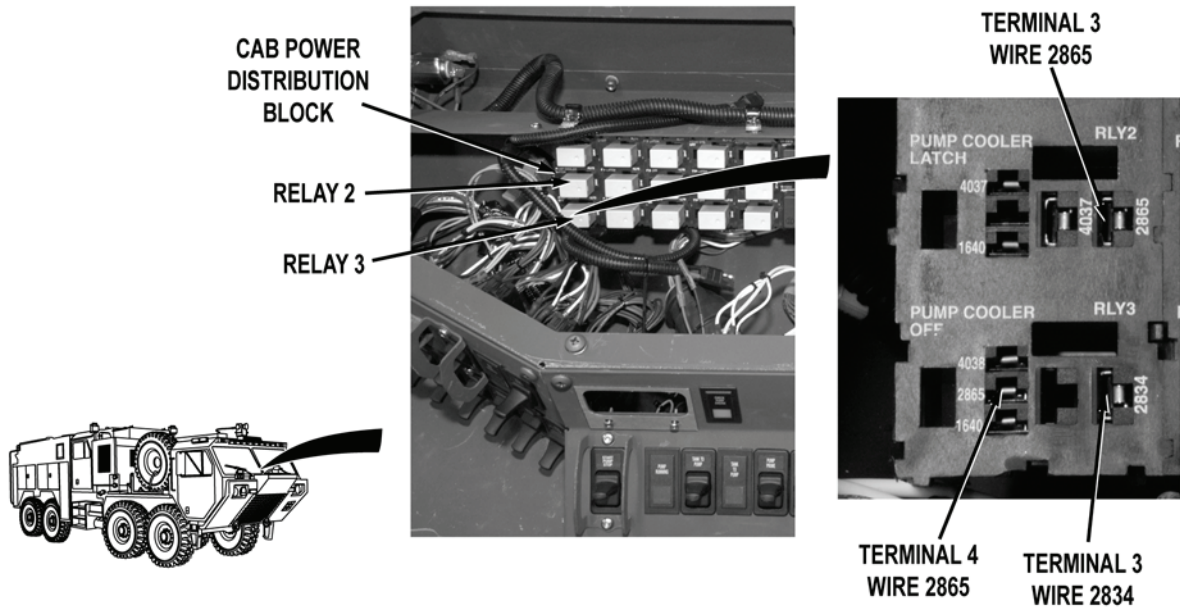
**MALFUNCTION****TEST OR INSPECTION****CORRECTIVE ACTION****WARNING**

**Remove rings, wristwatches, neck chains, and any other jewelry before working around vehicle. Jewelry can catch on equipment and cause serious injury. Jewelry and tools may short across electrical circuits and cause damage to equipment, or severe burns or electrical shock to personnel.**

- Step 24. Turn battery disconnect switch to OFF position (WP 0007). Remove relay 3 (WP 0402). Turn battery disconnect switch to ON position (WP 0007). Check for 22 to 28 VDC between cab power distribution wire harness wire 2834 (red) at relay 3 connector, terminal 3 and a known good ground.

If 22 to 28 VDC are not present, replace cab power distribution wire harness and block (WP 0441).

- Step 25. Turn battery disconnect switch to OFF position (WP 0007). Check for continuity across cab power distribution wire harness wire 2865 (gray) from relay 3 connector, terminal 4 to relay 2 connector, terminal 3.
- a. If there is continuity, replace relay 2 (WP 0402).
  - b. If there is no continuity, replace cab power distribution wire harness and block (WP 0441).

## MALFUNCTION

## TEST OR INSPECTION

## CORRECTIVE ACTION

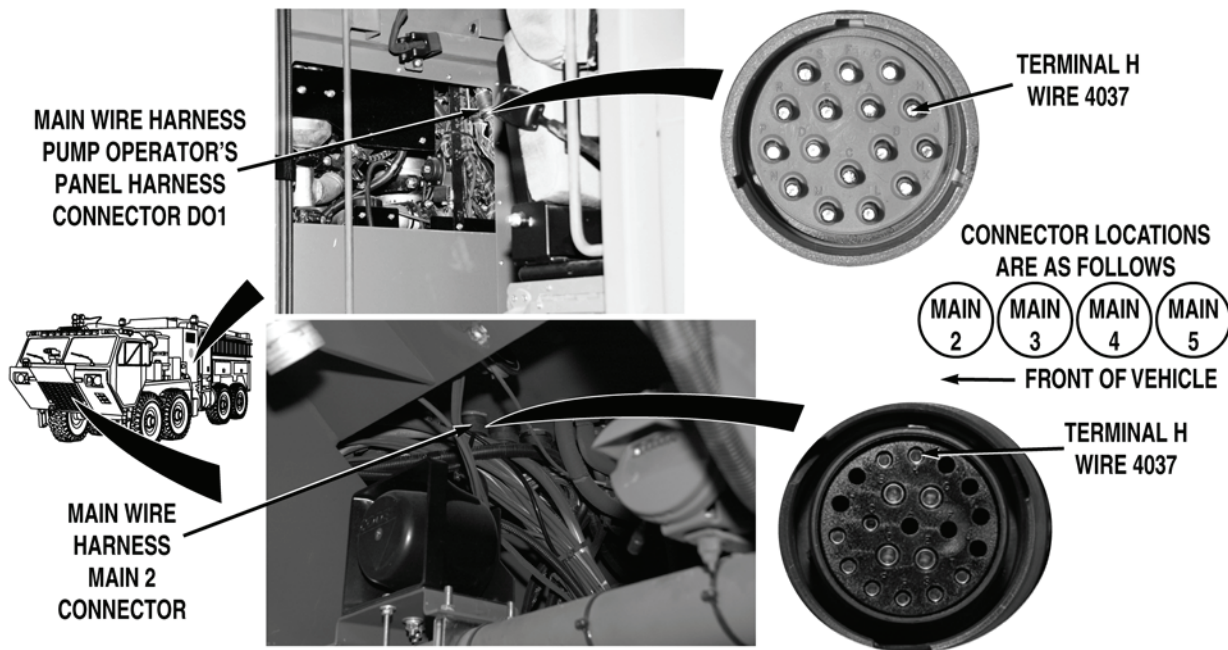
**WARNING**

Remove rings, wristwatches, neck chains, and any other jewelry before working around vehicle. Jewelry can catch on equipment and cause serious injury. Jewelry and tools may short across electrical circuits and cause damage to equipment, or severe burns or electrical shock to personnel.

- Step 26. Turn battery disconnect switch to OFF position (WP 0007). Remove driver side crew cab panel (WP 0499). Remove pump house panel Q (WP 0540). Disconnect main wire harness pump operator's panel wire harness connector. Remove skid plate grille (WP 0550). Disconnect main wire harness main 2 connector. With a test lead set, check for continuity across main wire harness wire 4037 (orange) from main wire harness pump operator's panel wire harness connector DO1, terminal H to main 2 connector, terminal H.
- If there is continuity, repair wire 4037 in cab power distribution wire harness if repairable (TM 9-2320-325-14&P), or replace cab power distribution wire harness and block (WP 0441).
  - If there is no continuity, repair wire 4037 in main wire harness if repairable (TM 9-2320-325-14&P), or replace main wire harness (WP 0455).

**MALFUNCTION**

**TEST OR INSPECTION**

**CORRECTIVE ACTION**

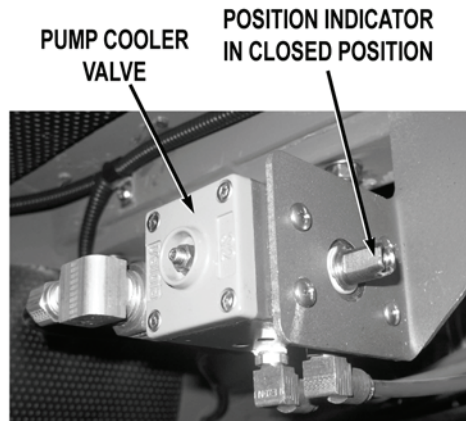
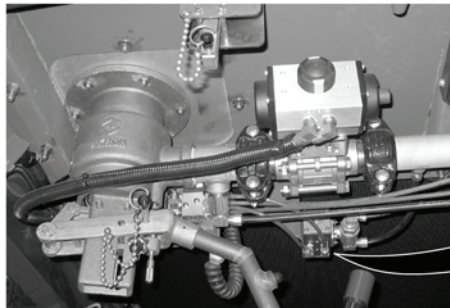
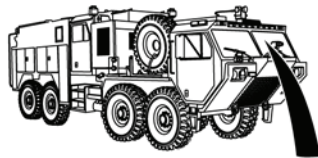

**NOTE**

- Ensure system air pressure is at least 85 psi (586 kPa) during this procedure. System air pressure is required to activate valves.
- Do not engage water pump engine during this procedure, except when performing complete system checks. Valve operations can be checked without water pump operation.
- Valve operations can be checked by observing valve shaft rotation.

Step 27. While an assistant puts cab PUMP COOLER switch to on position (WP 0004), check if pump cooler valve operates to open position.

If pump cooler valve does not operate to open position, go to Step 34.

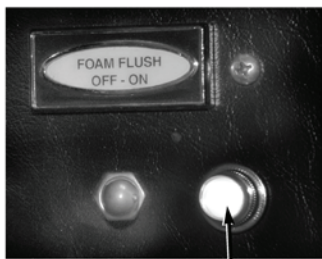

**FOAM FLUSH INDICATOR**

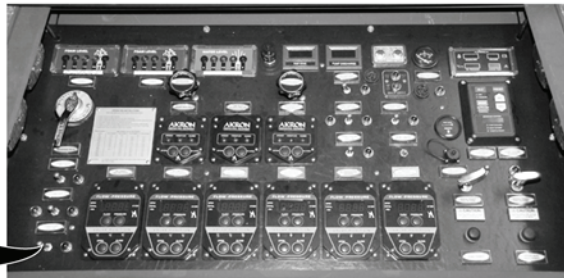

Step 28. Put cab PUMP COOLER switch to off position (WP 0004). Put pump operator's panel FOAM FLUSH switch to ON position (WP 0004). Check if FOAM FLUSH indicator illuminates.

If FOAM FLUSH indicator does not illuminate, go to Step 32.

**MALFUNCTION**

**TEST OR INSPECTION**

**CORRECTIVE ACTION**

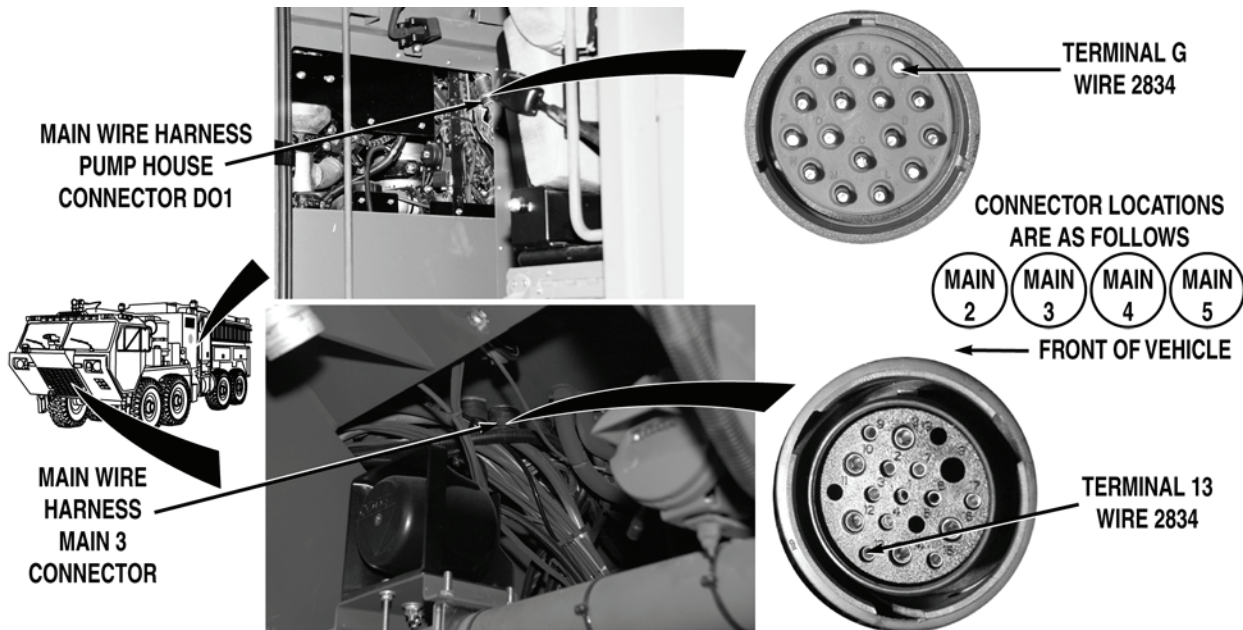

**WARNING**



**Remove rings, wristwatches, neck chains, and any other jewelry before working around vehicle. Jewelry can catch on equipment and cause serious injury. Jewelry and tools may short across electrical circuits and cause damage to equipment, or severe burns or electrical shock to personnel.**

Step 29. Put pump operator's panel FOAM FLUSH switch to OFF position (WP 0004). Turn battery disconnect switch to OFF position (WP 0007). Open pump operator's panel housing (WP 0325). Turn battery disconnect switch to ON position (WP 0007). With a test lead set, check for 22 to 28 VDC between pump operator's panel wire harness wire 2834 (red) at PUMP COOLER switch, terminal and a known good ground.

If 22 to 28 VDC are not present, repair wire 2834 in pump operator's panel wire harness if repairable (TM 9-2320-325-14&P), or replace pump operator's panel wire harness (WP 0459).

Step 30. Turn battery disconnect switch to OFF position (WP 0007). While an assistant holds pump operator's panel PUMP COOLER switch in ON position, check for continuity across pump operator's panel PUMP COOLER switch, from terminal wire 2834 (red) to terminal wire 4037 (orange).

If there is no continuity, replace pump operator's panel PUMP COOLER switch (WP 0337).



**MALFUNCTION**

**TEST OR INSPECTION**

**CORRECTIVE ACTION**

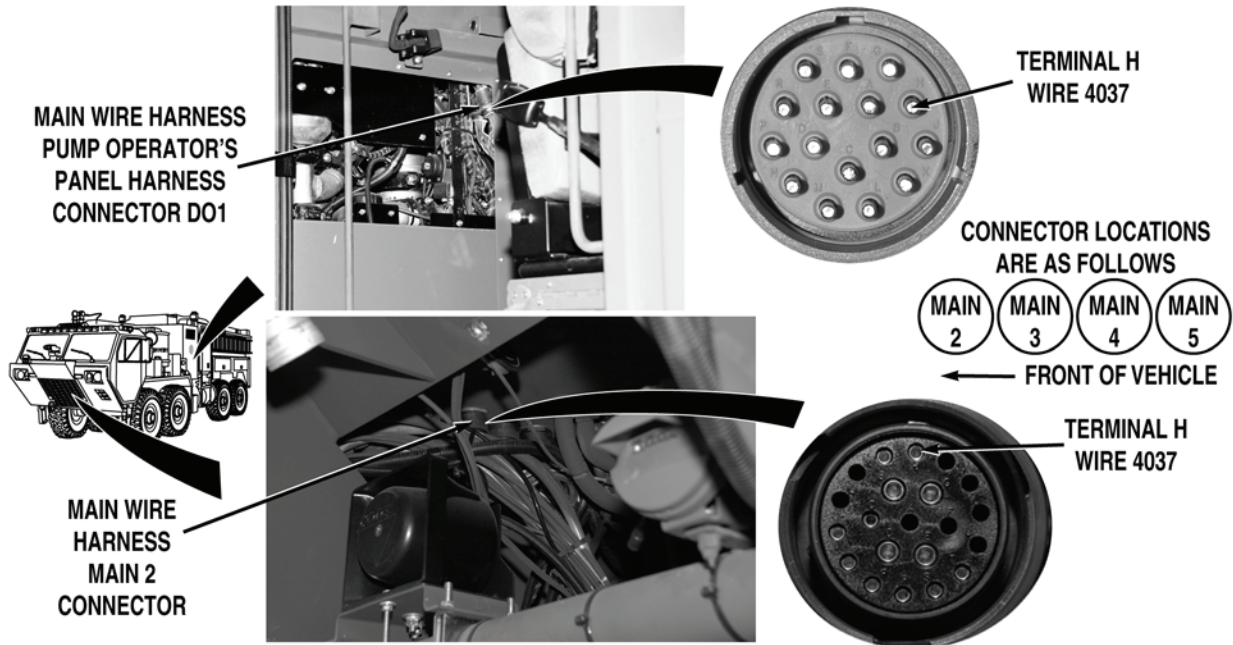

- Step 31. Disconnect main wire harness pump operator's panel wire harness connector DO1. Disconnect main wire harness main 2 harness connector. With a test lead set, check for continuity across main wire harness wire 4037 (orange) from main wire harness pump operator's panel wire harness connector DO1, terminal H to main wire harness main 2 wire harness connector, terminal 4.
- a. If there is continuity, repair wire 4037 in pump operator's panel wire harness if repairable (TM 9-2320-325-14&P), or replace pump operator's panel wire harness (WP 0459).
  - b. If there is no continuity, repair wire 4037 in main wire harness if repairable (TM 9-2320-325-14&P), or replace main wire harness (WP 0455).

**MALFUNCTION**

**TEST OR INSPECTION**

**CORRECTIVE ACTION**

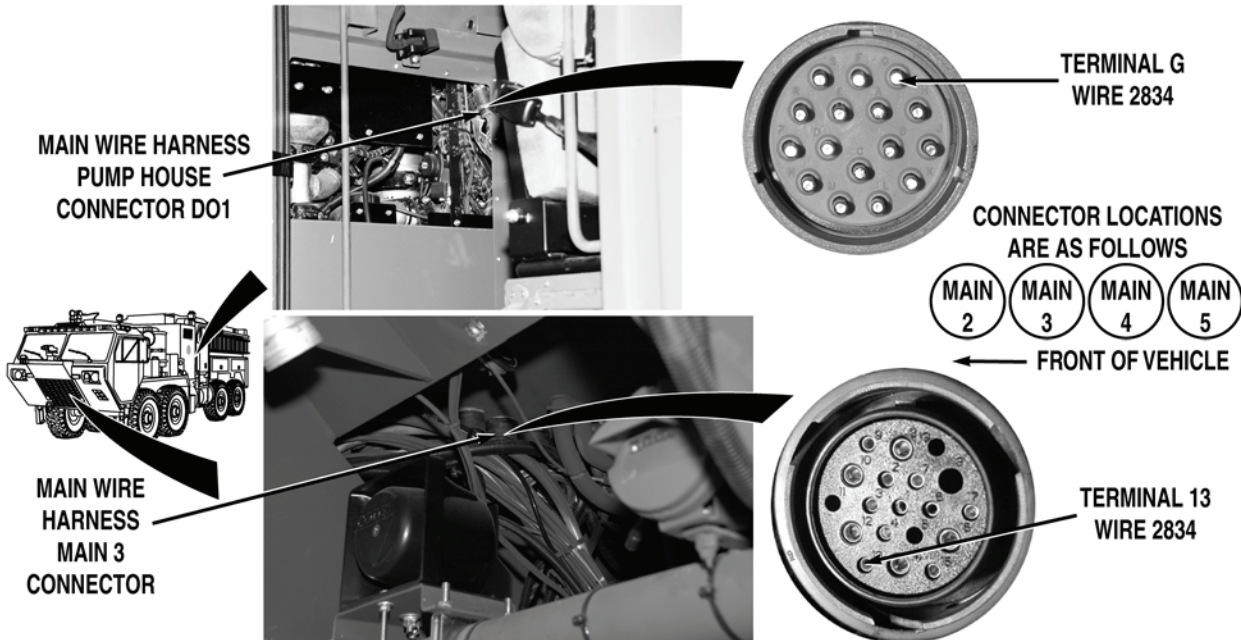

**WARNING**



**Remove rings, wristwatches, neck chains, and any other jewelry before working around vehicle. Jewelry can catch on equipment and cause serious injury. Jewelry and tools may short across electrical circuits and cause damage to equipment, or severe burns or electrical shock to personnel.**

- Step 32. Put pump operator's panel FOAM FLUSH switch to OFF position (WP 0004). Disconnect main wire harness pump operator's panel wire harness connector DO1. With a test lead set, check for 22 to 28 VDC between main wire harness wire 2834 (red) at main wire harness pump operator's panel wire harness connector DO1, terminal G and a known good ground.

If 22 to 28 VDC are present, repair wire 2834 in pump operator's panel wire harness if repairable (TM 9-2320-325-14&P), or replace pump operator's panel wire harness (WP 0459).

**MALFUNCTION****TEST OR INSPECTION****CORRECTIVE ACTION**

- Step 33. Remove skid plate grille (WP 0550). Turn battery disconnect switch to OFF position (WP 0007). Disconnect main wire harness main 3 connector. With a test lead set, check for continuity across main wire harness wire 2834 (red) from main 3 connector, terminal 13 to main wire harness pump operator's panel wire harness connector DO1, terminal G.
- a. If there is continuity, repair wire 2834 in cab power distribution wire harness if repairable (TM 9-2320-325-14&P), or replace cab power distribution wire harness and block (WP 0441).
  - b. If there is no continuity, repair wire 2834 if repairable (TM 9-2320-325-14&P), or replace main wire harness (WP 0455).

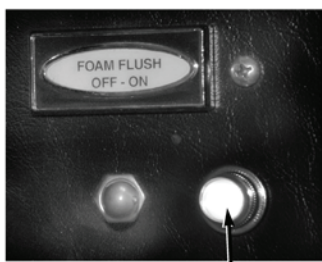

FOAM FLUSH INDICATOR

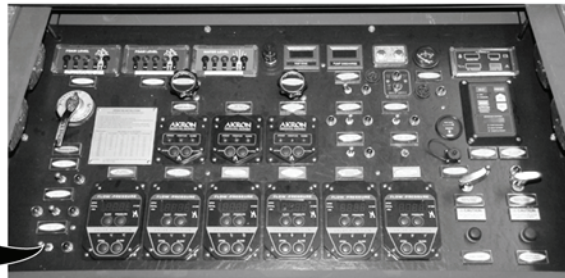

- Step 34. Put cab PUMP COOLER switch to off position (WP 0004) and release. Put pump operator's panel FOAM FLUSH switch to ON position (WP 0004). Check if FOAM FLUSH indicator illuminates.

If FOAM FLUSH indicator does not illuminate, go to Step 42.

**MALFUNCTION**

**TEST OR INSPECTION**

**CORRECTIVE ACTION**

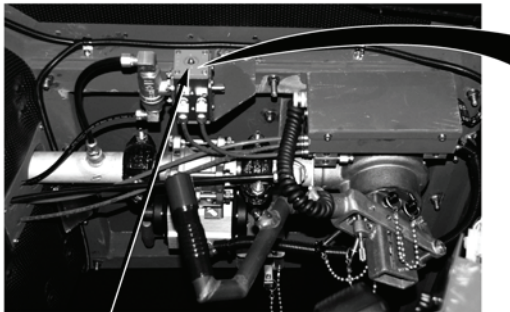

**PUMP COOLER VALVE**

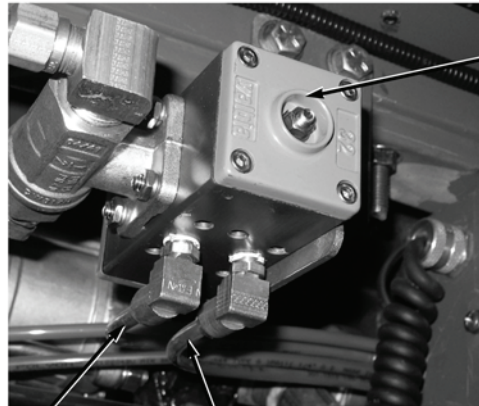

**PUMP COOLER VALVE**

**RED AIR LINE**

**BLUE AIR LINE**

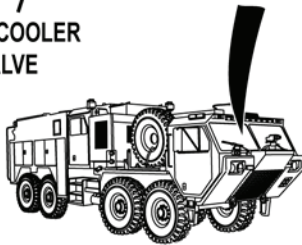

Step 35. Put FOAM FLUSH switch to OFF position (WP 0004). Inspect air lines from air control valve manifold to pump cooler valve for leaks, kinks, or damage.

If air lines are not free of links, kinks, or damage, replace damaged air lines (WP 0567).

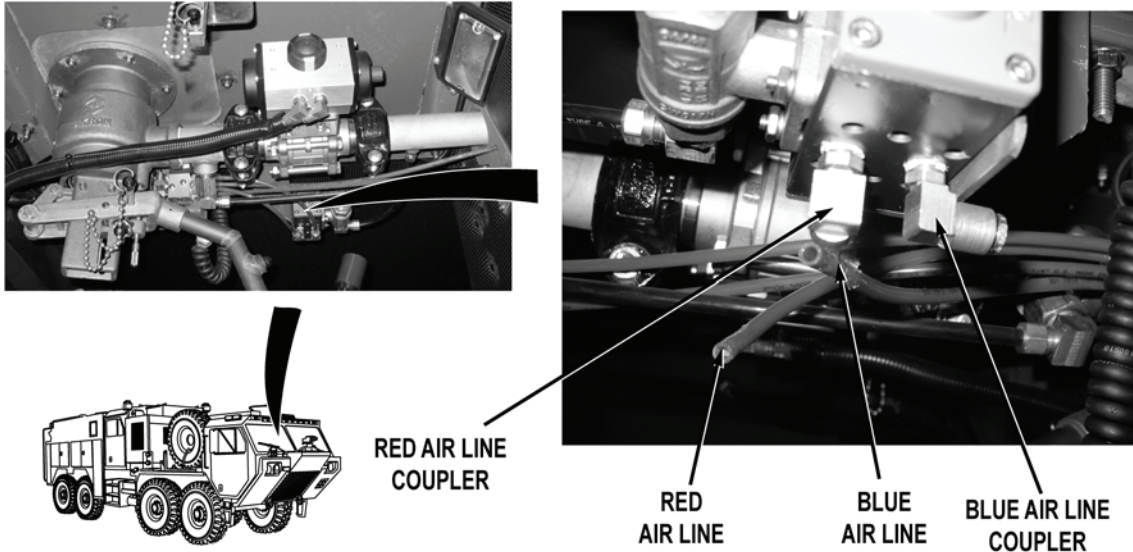
**MALFUNCTION****TEST OR INSPECTION****CORRECTIVE ACTION****WARNING**

- If air lines are under pressure when they are disconnected, they can whip around and cause injury to personnel. Caution should be exercised when disconnecting air line fittings.
- Air lines may be under pressure when control valve is operated. If under pressure and air lines are disconnected, air lines may whip around and cause injury to personnel. Caution should be exercised when operating control valve with air lines disconnected.

**NOTE**

Air pressure is checked by disconnecting air lines at pump cooler valve and observing air pressure escaping from air line, when pump cooler control valve is activated. Air will escape from blue air line when PUMP COOLER switch is put to ON position, and escape from red air line when PUMP COOLER switch is put to OFF position. System air pressure may drop below 85 psi (586 kPa) during this procedure.

- Step 36. Disconnect air lines at pump cooler valve. Put cab or pump operator's panel PUMP COOLER switch to ON and OFF positions (WP 0004), check if air pressure is present at pump cooler valve.

If there is air pressure, replace pump cooler valve (WP 0578).

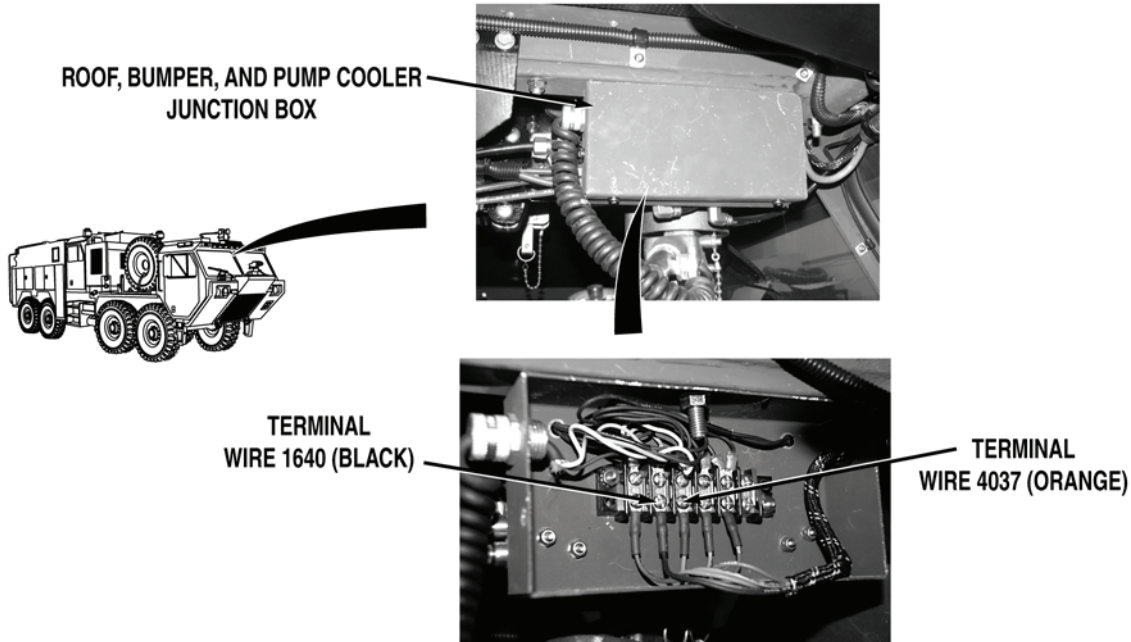
**MALFUNCTION****TEST OR INSPECTION****CORRECTIVE ACTION****WARNING**

**Remove rings, wristwatches, neck chains, and any other jewelry before working around vehicle. Jewelry can catch on equipment and cause serious injury. Jewelry and tools may short across electrical circuits and cause damage to equipment, or severe burns or electrical shock to personnel.**

- Step 37. Open roof, bumper, and pump cooler junction box (WP 0423). Put cab or pump operator's panel PUMP COOLER switch to ON position (WP 0004) and release. Check for 22 to 28 VDC between cab roof wire harness wire 4037 (orange) at roof, bumper, and pump cooler junction box terminal strip and a known good ground.

If 22 to 28 VDC are not present, go to Step 40.

- Step 38. Turn battery disconnect switch to OFF position (WP 0007). With a test lead set, check for continuity across wire 1640 (black) from roof, bumper, and pump cooler junction box to a known good ground.

If there is continuity, replace pump cooler control valve (WP 0370).

---

**MALFUNCTION**  
**TEST OR INSPECTION**  
**CORRECTIVE ACTION**

---

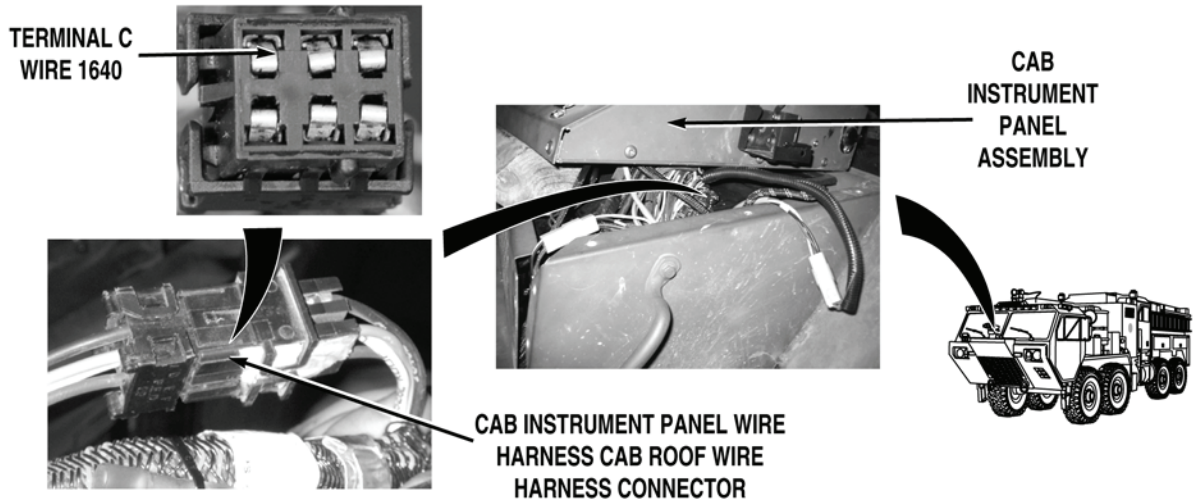

- Step 39. Remove personnel cab panel C (WP 0311). Disconnect cab instrument panel cab roof wire harness connector. With a test lead set, check for continuity across wire 1640 (black) from roof, bumper, and pump cooler junction box to cab roof wire harness connector terminal C.
- a. If there is continuity, repair wire 1640 in cab instrument panel wire harness if repairable (TM 9-2320-325-14&P), or replace cab instrument panel wire harness (WP 0440).
  - b. If there is no continuity, repair wire 1640 in cab roof wire harness if repairable (TM 9-2320-325-14&P), or replace cab roof wire harness (WP 0442).

**MALFUNCTION**

**TEST OR INSPECTION**

**CORRECTIVE ACTION**

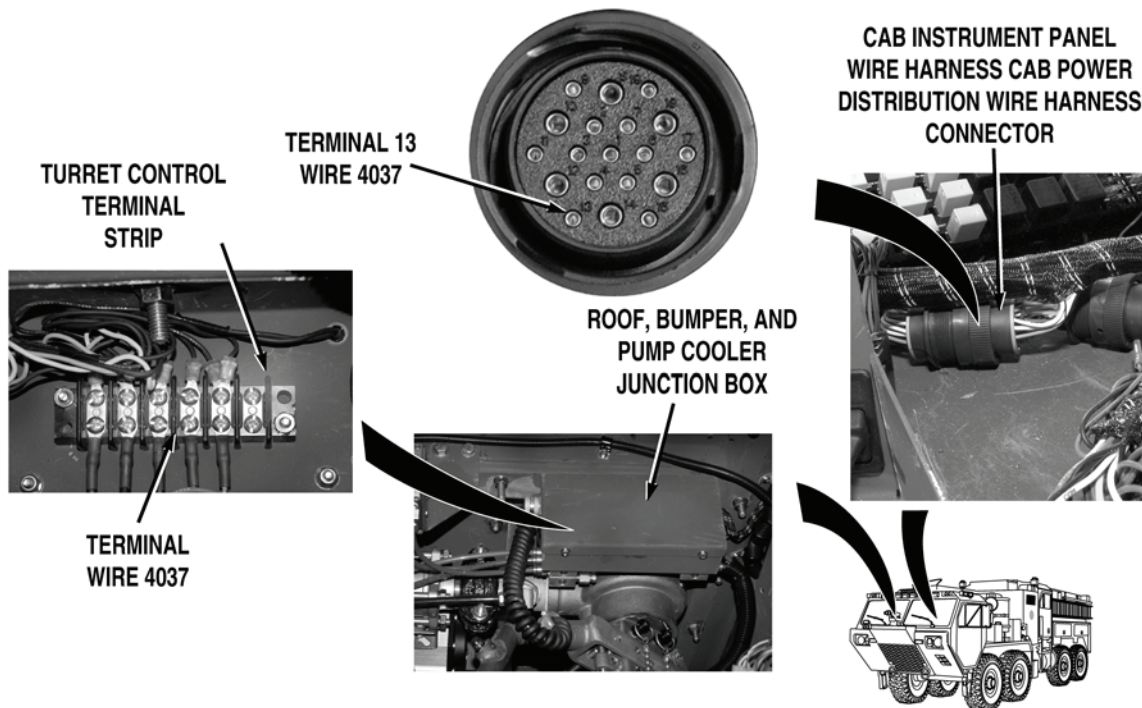

**WARNING**



**Remove rings, wristwatches, neck chains, and any other jewelry before working around vehicle. Jewelry can catch on equipment and cause serious injury. Jewelry and tools may short across electrical circuits and cause damage to equipment, or severe burns or electrical shock to personnel.**

Step 40. Turn battery disconnect switch to OFF position (WP 0007). Disconnect cab instrument panel cab power distribution wire harness connector. With a test lead set, check for continuity across wire 4037 (orange) from cab instrument panel wire harness connector terminal 13 to turret control junction box terminal strip.

If there is continuity, repair wire 4037 in cab power distribution wire harness if repairable (TM 9-2320-325-14&P), or replace cab power distribution wire harness and block (WP 0441).

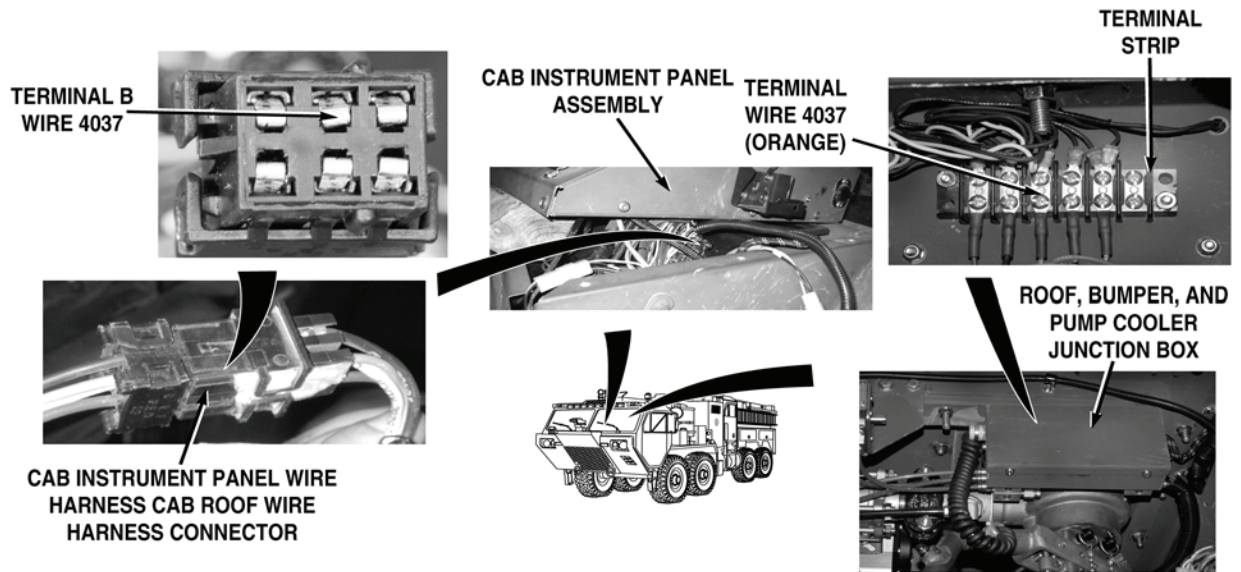

**MALFUNCTION****TEST OR INSPECTION****CORRECTIVE ACTION**

- Step 41. Remove personnel cab panel C (WP 0311). Disconnect cab instrument panel cab roof wire harness connector. With a test lead set, check for continuity across wire 4037 (orange) from turret control junction box to cab roof wire harness connector terminal B.
- a. If there is continuity, repair wire 4037 in cab instrument panel wire harness if repairable (TM 9-2320-325-14&P), or replace cab instrument panel wire harness (WP 0440).
  - b. If there is no continuity, repair wire 4037 in cab roof wire harness if repairable (TM 9-2320-325-14&P), or replace cab roof wire harness (WP 0442).

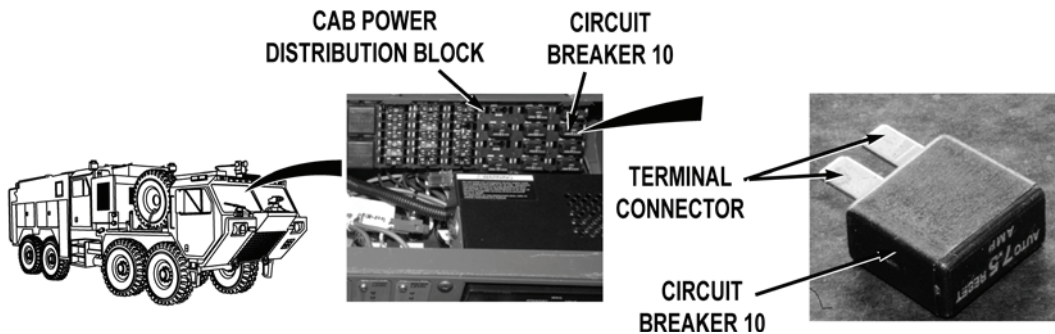
**MALFUNCTION****TEST OR INSPECTION****CORRECTIVE ACTION****WARNING**

**Remove rings, wristwatches, neck chains, and any other jewelry before working around vehicle. Jewelry can catch on equipment and cause serious injury. Jewelry and tools may short across electrical circuits and cause damage to equipment, or severe burns or electrical shock to personnel.**

- Step 42. Put FOAM FLUSH switch to off position (WP 0004). Turn battery disconnect switch to OFF position (WP 0007). Remove cab instrument panel A (WP 0311). Remove circuit breaker 10 (WP 0398). Check for continuity across circuit breaker.

If there is no continuity, replace circuit breaker 10 (WP 0398).

- Step 43. Turn battery disconnect switch to ON position (WP 0007). Check for 22 to 28 VDC at terminal wire 1138 in cab power distribution block.
- a. If there is 22 to 28 VDC, repair wire 2834 in cab power distribution wire harness if repairable (TM 9-2320-325-14&P), or replace cab power distribution wire harness and block (WP 0441).
  - b. If there is not 22 to 28 VDC, repair wire 1138 in cab power distribution wire harness if repairable (TM 9-2320-325-14&P), or replace cab power distribution wire harness and block (WP 0441).

**END OF TASK****FOLLOW-ON MAINTENANCE**

Remove wheel chocks (TM 9-2320-347-10)

**END OF TASK****END OF WORK PACKAGE**

**3FIELD LEVEL MAINTENANCE**

**PUMP PRIMING SYSTEM DOES NOT OPERATE PROPERLY**

**INITIAL SETUP:**

**Tools and Special Tools**

- Lead Set, Test (WP 0622, Item 21)
- Tool Kit, General Mechanic's: Automotive (WP 0622, Item 27)

**Personnel Required**

- MOS 63B Wheeled vehicle mechanic (2)

**References**

- WP 0004
- WP 0007
- WP 0023
- WP 0025
- WP 0260
- WP 0261
- WP 0262
- WP 0265
- WP 0267
- WP 0268
- WP 0311
- WP 0315

**References (continued)**

- WP 0325
- WP 0333
- WP 0393
- WP 0419
- WP 0443
- WP 0455
- WP 0458
- WP 0459
- WP 0490
- WP 0499
- WP 0539
- WP 0540
- WP 0550

**Equipment Conditions**

- Water pump engine OFF (WP 0022)
- Engine OFF (TM 9-2320-347-10)
- Wheels chocked (TM 9-2320-347-10)

**MALFUNCTION**

**TEST OR INSPECTION**

**CORRECTIVE ACTION**

**PUMP PRIMING SYSTEM DOES NOT OPERATE PROPERLY**

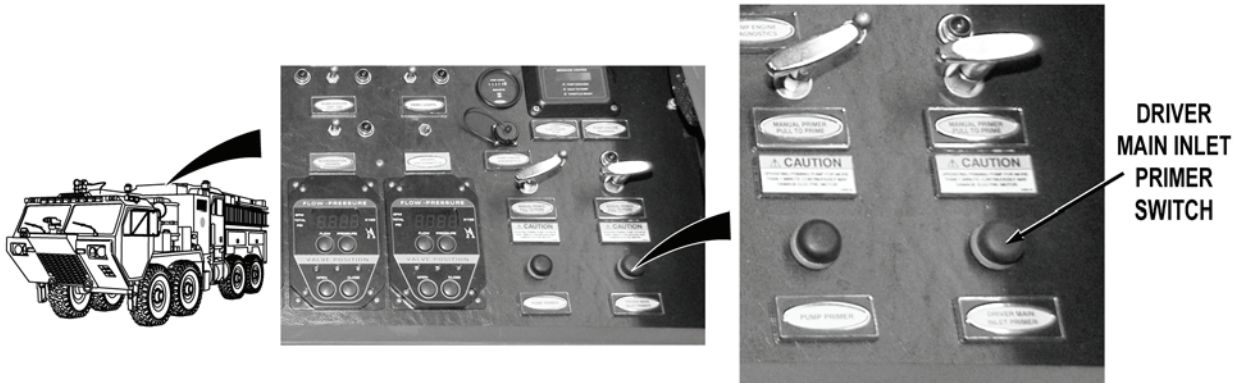
**MALFUNCTION****TEST OR INSPECTION****CORRECTIVE ACTION****NOTE**

Primer pump operation can be checked by noting the loud and distinguishable audible vibration of primer pump.

- Step 1. Turn battery disconnect switch to ON position (WP 0007). Prepare vehicle to pump from draft (WP 0025). Press pump operator's panel DRIVER MAIN INLET PRIMER switch (WP 0004). Check for primer pump operation.

If primer pump does not operate when pump operator's panel DRIVER MAIN INLET PRIMER switch is pressed, go to Step 27.

- Step 2. Push pump operator's panel DRIVER MAIN INLET PRIMER switch (WP 0004). Check if primer pump draws water to water pump (WP 0025).

If primer pump operates but does not draw water to water pump, go to Step 8.

---

MALFUNCTION	TEST OR INSPECTION	CORRECTIVE ACTION
-------------	--------------------	-------------------

---

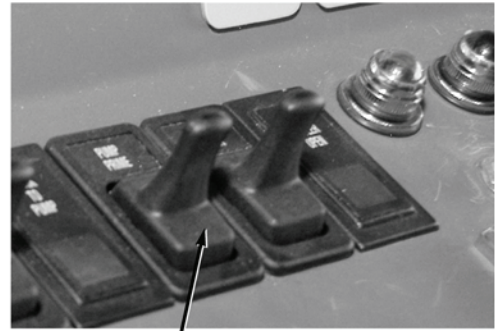
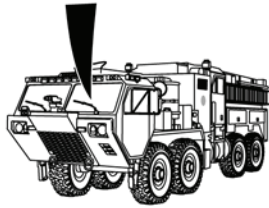

PERSONNEL CAB  
PUMP PRIME SWITCH

Step 3. Put personnel cab PUMP PRIME switch to on position (WP 0004). Check if primer pump operates.

If primer pump operates, fault corrected.

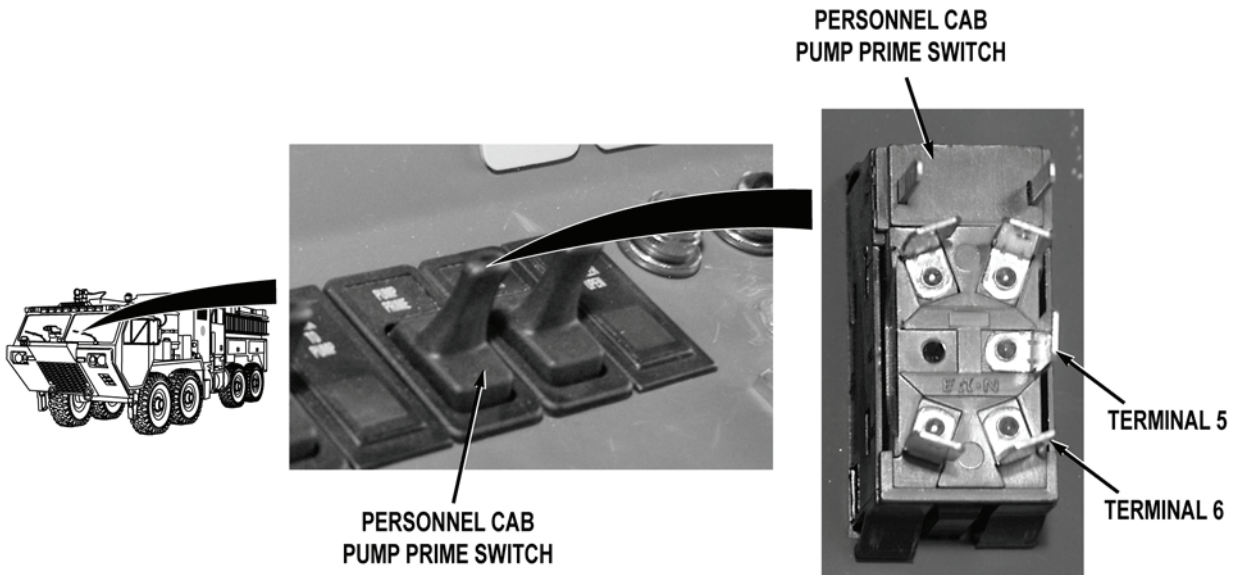
**MALFUNCTION****TEST OR INSPECTION****CORRECTIVE ACTION****WARNING**

**Remove rings, wristwatches, neck chains, and any other jewelry before working around vehicle. Jewelry can catch on equipment and cause serious injury. Jewelry and tools may short across electrical circuits and cause damage to equipment, or severe burns or electrical shock to personnel.**

- Step 4. Turn battery disconnect switch to OFF position (WP 0007). Remove personnel cab instrument panel B (WP 0311). Disconnect cab pump control wire harness PUMP PRIME switch connector. While an assistant holds personnel cab PUMP PRIME switch from terminal 5 to terminal 6.

If continuity is not present, replace personnel cab PUMP PRIME switch (WP 0315).

**MALFUNCTION**

**TEST OR INSPECTION**

**CORRECTIVE ACTION**

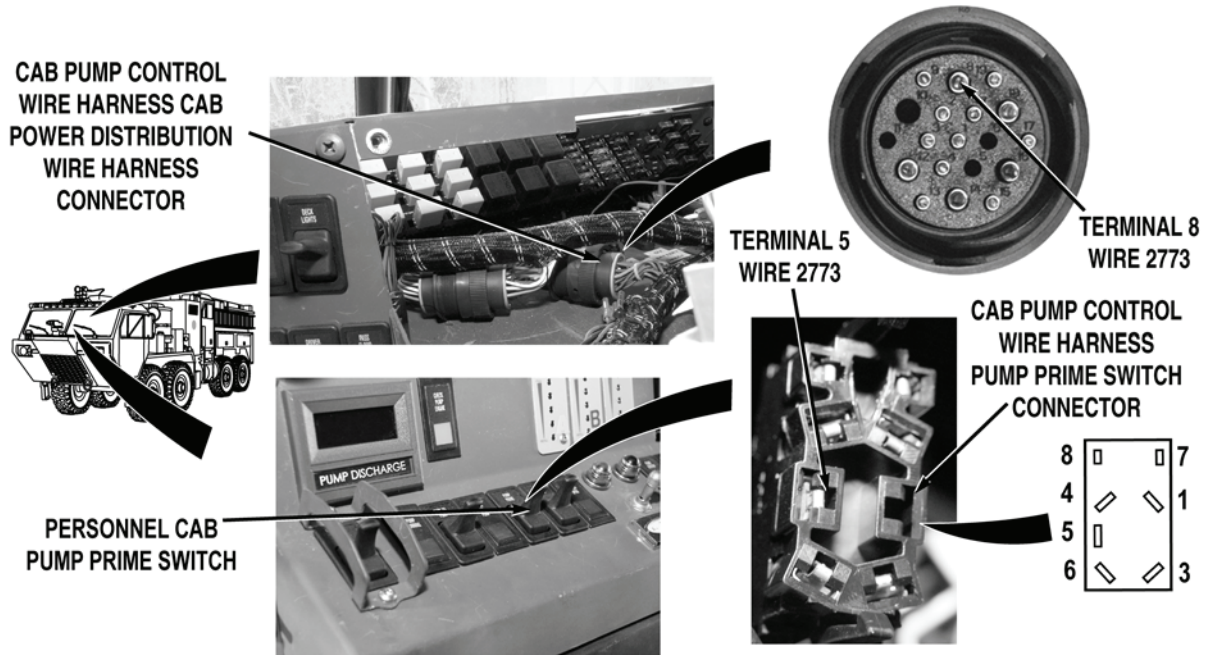

Step 5. Disconnect cab pump control wire harness cab power distribution wire harness connector. With a test lead set, check continuity across cab pump control wire harness wire 2773 (red) from cab pump control wire harness cab PUMP PRIME switch connector terminal 5, to cab pump control wire harness cab power distribution wire harness connector, terminal 8.

If continuity is not present, repair wire 2773 in cab pump control wire harness if repairable (TM 9-2320-325-14&P), or replace cab pump control wire harness (WP 0443).

**MALFUNCTION**

**TEST OR INSPECTION**

**CORRECTIVE ACTION**

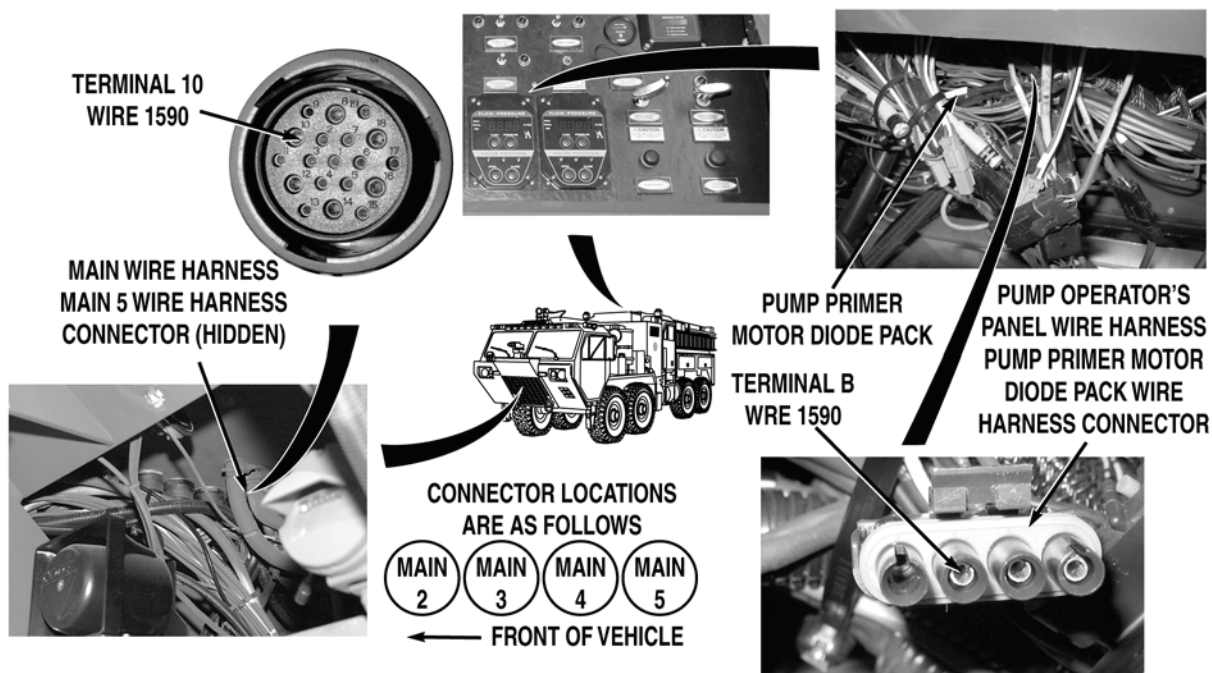

Step 6. Remove skid plate grille (WP 0550). Disconnect main wire harness main 5 wire harness connector. Open pump operator's panel housing (WP 0325). Remove pump primer motor diode pack (WP 0419). With a test lead set, check continuity across wire 1590 (red) from main wire harness main 5 wire harness connector, terminal 10 to pump operator's panel pump primer motor diode pack connector, terminal B.

If continuity is present, repair wire 1590 in cab pump control wire harness if repairable (TM 9-2320-325-14&P), or replace cab pump control wire harness (WP 0443).



## MALFUNCTION

## TEST OR INSPECTION

## CORRECTIVE ACTION

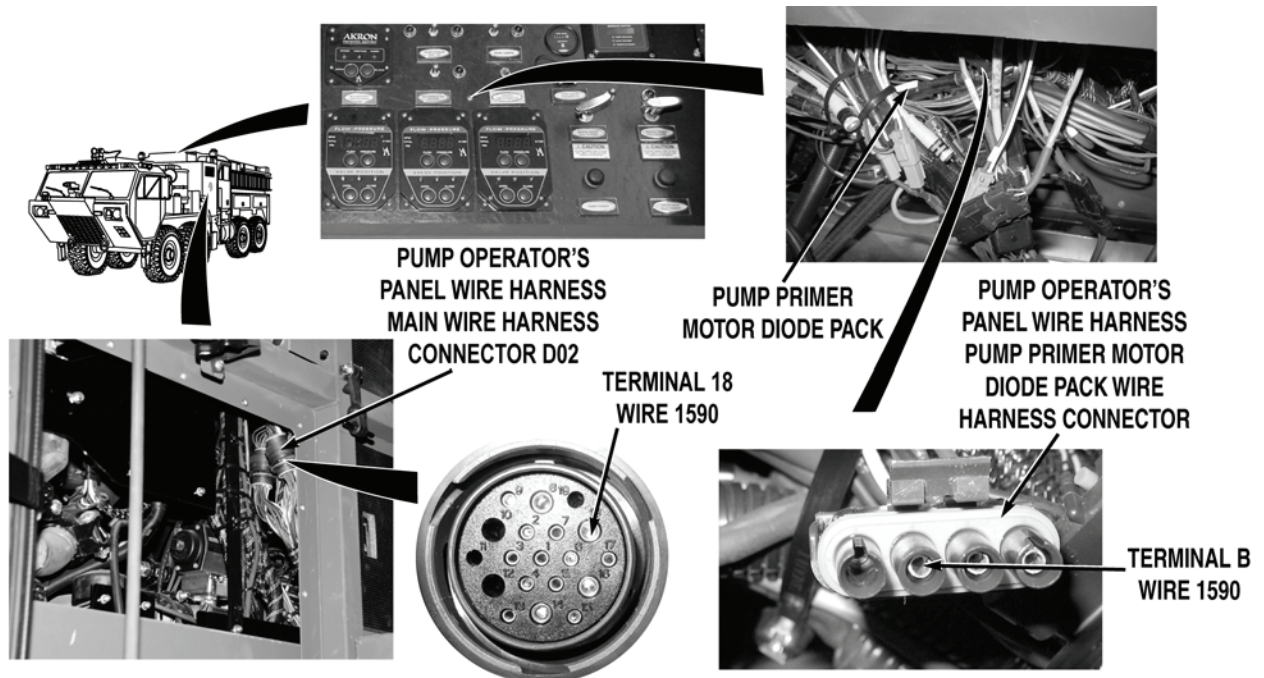

- Step 7. Connect main wire harness main 5 wire harness connector. Remove driver side crew cab access panel (WP 0499). Remove pump house panel Q (WP 0325). Disconnect pump operator's panel wire harness main wire harness connector DO 2. With a test lead set, check continuity across wire 1590 (red) from pump operator's panel wire harness main wire harness connector DO 2, terminal 18, to pump operator's panel wire harness pump primer motor diode pack connector, terminal B.
- If continuity is present, repair wire 1590 in main wire harness if repairable (TM 9-2320-325-14&P), or replace main wire harness (WP 0455).
  - If continuity is not present, repair wire 1590 in pump operator's panel wire harness if repairable (TM 9-2320-325-14&P), or replace pump operator's panel wire harness (WP 0459).
- Step 8. Prepare vehicle to pump from draft (WP 0025). Pull DRIVER MAIN INLET manual priming cable to close position (WP 0023). Check if water is drawn to water pump (WP 0025).

If water is not drawn to water pump, go to Step 20.

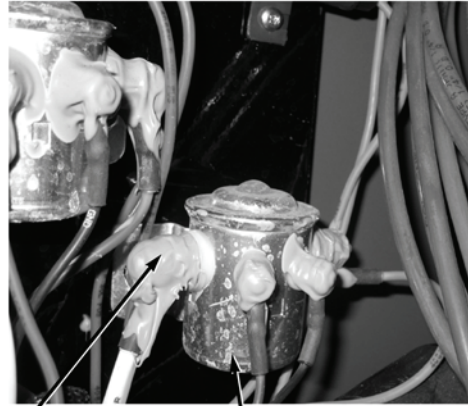
**MALFUNCTION****TEST OR INSPECTION****CORRECTIVE ACTION**

TERMINAL  
WIRE 2768

DRIVER MAIN INLET  
PRIMER VALVE CONTROL  
SOLENOID

- Step 9. Open pump house panel A (WP 0539). While an assistant presses pump operator's panel DRIVER MAIN INLET PRIMER switch (WP 0004), check if driver main inlet primer valve control solenoid is operating. Operation can be checked by listening for a metallic clicking sound and slight movement of solenoid.

If driver main inlet primer valve control solenoid does not click and slightly move, go to Step 17.

**WARNING**



**Remove rings, wristwatches, neck chains, and any other jewelry before working around vehicle. Jewelry can catch on equipment and cause serious injury. Jewelry and tools may short across electrical circuits and cause damage to equipment, or severe burns or electrical shock to personnel.**

- Step 10. Check for 22 to 28 VDC between driver main inlet primer valve control solenoid terminal wire 2768 (white) and a known good ground.

If 22 to 28 VDC are not present, go to Step 15.

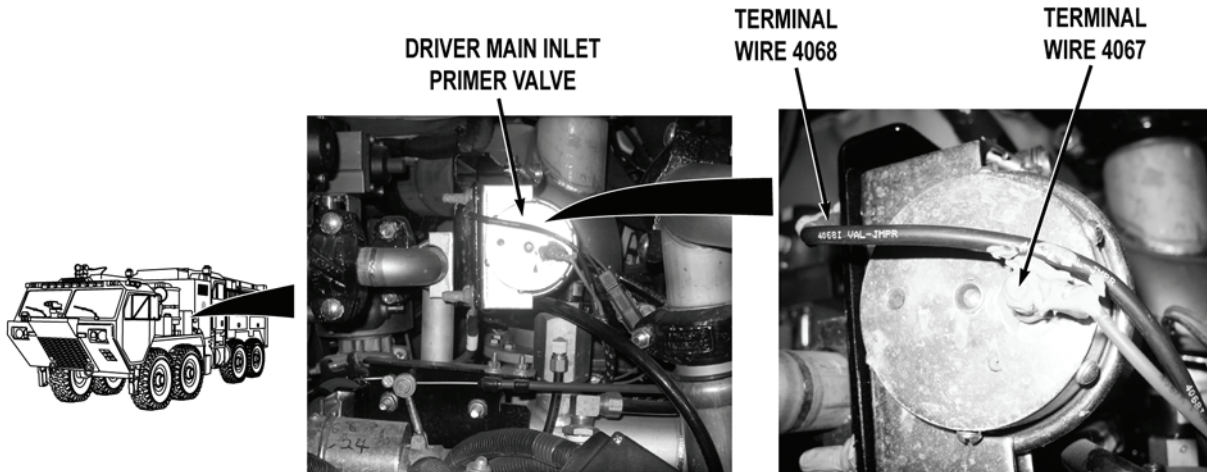
**MALFUNCTION****TEST OR INSPECTION****CORRECTIVE ACTION**

- Step 11. While an assistant pushes and holds pump operator's panel DRIVER MAIN INLET PRIMER switch (WP 0004), check for 22 to 28 VDC between pump house wire harness wire 4067 (orange) at driver main inlet primer valve and a known good ground.

If 22 to 28 VDC are not present, go to Step 13.

- Step 12. Turn battery disconnect switch to OFF position (WP 0007). Disconnect pump house wire harness wire 4068 (black) from driver main inlet primer valve terminal (WP 0268). Check for continuity across wire 4068 (black) from wire termination to a known good ground.
- a. If continuity is present, replace primer valve (WP 0268).
  - b. If continuity is not present, repair wire 4068 in pump house wire harness if repairable (TM 9-2320-325-14&P), or replace pump house wire harness (WP 0458).

## MALFUNCTION

## TEST OR INSPECTION

## CORRECTIVE ACTION

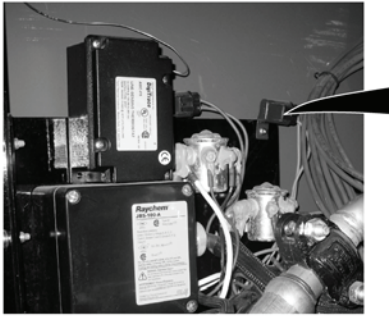

PUMP HOUSE WIRE  
HARNES DRIVER MAIN  
INLET PRIMER VALVE  
INLINE FUSE CONNECTOR

TERMINAL  
WIRE 4066



TERMINAL  
CONNECTORS

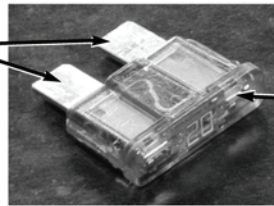

DRIVER MAIN INLET  
PRIMER VALVE  
INLINE FUSE

Step 13. Turn battery disconnect switch to OFF position (WP 0007). Remove driver main inlet primer valve inline fuse (WP 0261). Turn battery disconnect switch to ON position (WP 0007). While an assistant pushes and holds pump operator's panel DRIVER MAIN INLET PRIMER switch (WP 0004), check for 22 to 28 VDC between pump house wire harness driver main inlet primer valve inline fuse connector, terminal wire 4066 (orange) and a known good ground.

If 22 to 28 VDC are not present, replace driver main inlet primer valve control solenoid (WP 0266).

Step 14. Check for continuity across driver main inlet primer valve inline fuse from terminal to terminal.

- a. If continuity is present, repair wire 4067 in pump house wire harness if repairable (TM 9-2320-325-14&P), or replace pump house wire harness (WP 0458).
- b. If continuity is not present, replace driver main inlet primer valve inline fuse (WP 0261).

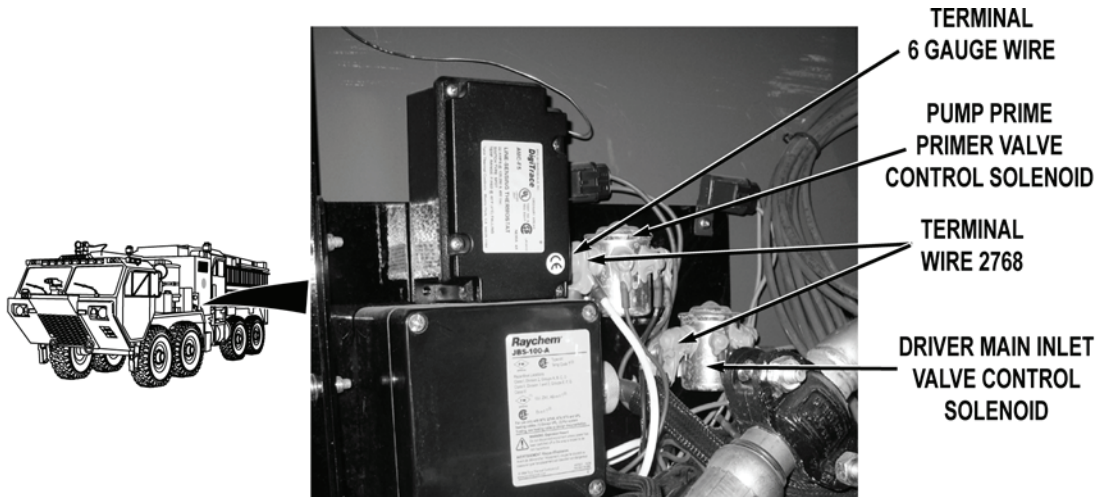
**MALFUNCTION****TEST OR INSPECTION****CORRECTIVE ACTION**

- Step 15. Check for 22 to 28 VDC between 6 gauge wire at driver main inlet primer valve control solenoid terminal and a known good ground.

If 22 to 28 VDC are not present, replace 6 gauge wire from driver main inlet primer valve control solenoid to pump house B+ stud (WP 0393).

- Step 16. Turn battery disconnect switch to OFF position (WP 0007). Disconnect jumperwire 2768 (white) from driver main inlet primer valve control solenoid terminal and pump prime primer valve control solenoid terminal (WP 0266). Check for continuity across jumperwire 2768 (white).
- If continuity is present, replace driver main inlet primer valve control solenoid (WP 0266).
  - If continuity is not present, repair jumperwire 2768 if repairable, or replace jumperwire (TM 9-2320-325-14&P).

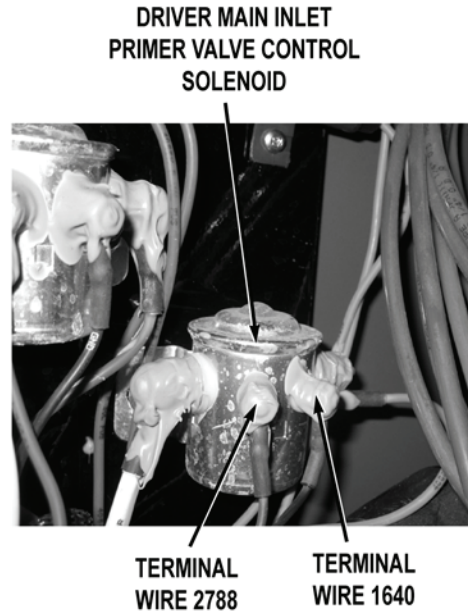
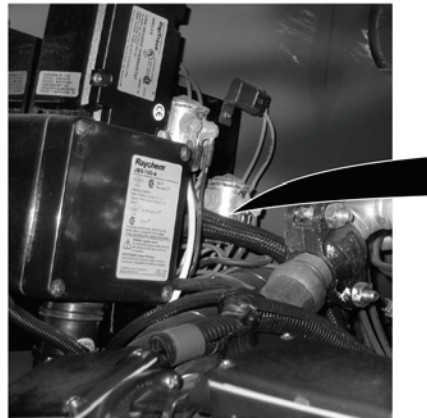
**MALFUNCTION****TEST OR INSPECTION****CORRECTIVE ACTION**

- Step 17. While an assistant pushes and holds pump operator's panel DRIVER MAIN INLET PRIMER switch (WP 0004), check for 22 to 28 VDC between pump house wire 2788 (blue) at driver main inlet primer valve control solenoid and a good ground.

If 22 to 28 VDC are not present, go to Step 19.

- Step 18. Turn battery disconnect switch to OFF position (WP 0007). Check for continuity across pump house wire 1640 (black) from driver main inlet primer valve control solenoid terminal to a known good ground.
- a. If continuity is present, replace driver main inlet primer valve control solenoid (WP 0266).
  - b. If continuity is not present, repair wire 1640 in pump house wire harness if repairable (TM 9-2320-325-14&P), or replace pump house wire harness (WP 0458).

**MALFUNCTION****TEST OR INSPECTION****CORRECTIVE ACTION**

PUMP HOUSE WIRE HARNESS  
PUMP OPERATOR'S PANEL  
WIRE HARNESS CONNECTOR

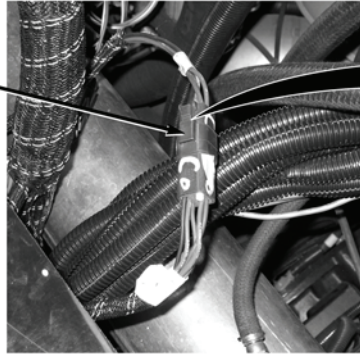

TERMINAL 5  
WIRE 2788

**WARNING**

**Remove rings, wristwatches, neck chains, and any other jewelry before working around vehicle. Jewelry can catch on equipment and cause serious injury. Jewelry and tools may short across electrical circuits and cause damage to equipment, or severe burns or electrical shock to personnel.**

- Step 19. Turn battery disconnect switch to OFF position (WP 0007). Open pump operator's panel housing (WP 0325). Disconnect pump house wire harness pump operator's panel wire harness connector. Turn battery disconnect switch to ON position (WP 0007). While an assistant pushes and holds pump operator's panel DRIVER MAIN INLET PRIMER switch (WP 0004). With a test lead set, check for 22 to 28 VDC between pump operator's panel wire harness wire 2788 (blue) at pump operator's panel wire harness pump house wire harness connector, terminal 5 and a known good ground.
- a. If 22 to 28 VDC are present, repair wire 2788 in pump house wire harness if repairable (TM 9-2320-325-14&P), or replace pump house wire harness (WP 0458).
  - b. If 22 to 28 VDC are not present, repair wire 2788 in pump operator's panel wire harness if repairable (TM 9-2320-325-14&P), or replace pump operator's panel wire harness (WP 0459).

---

**MALFUNCTION****TEST OR INSPECTION****CORRECTIVE ACTION**

---

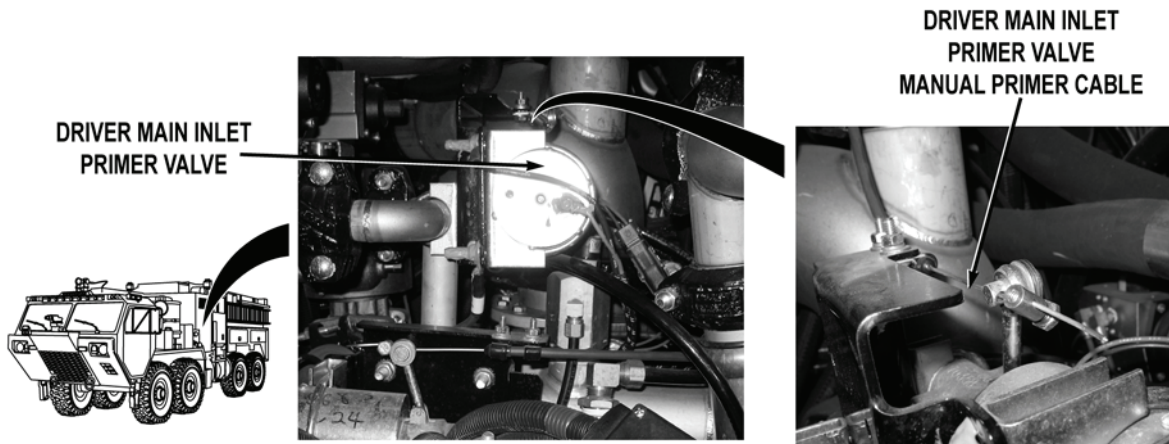

- Step 20. Open pump house panel A (WP 0539). Check driver main inlet primer valve manual primer cable for binding and damage.

If manual primer cable is binding or damaged, replace primer valve cable (WP 0265).



**MALFUNCTION**

**TEST OR INSPECTION**

**CORRECTIVE ACTION**

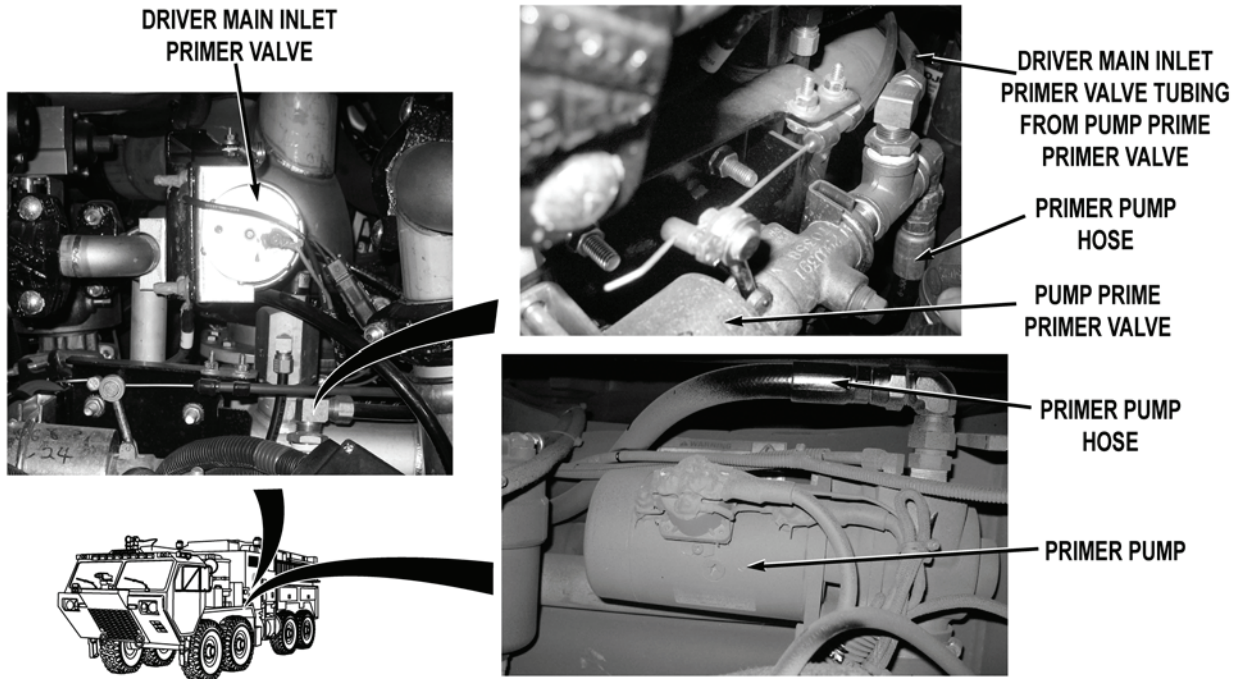

Step 21. Check primer pump hose from primer pump to pump prime primer valve fitting for leaks, kinks, or damage.

If hose is free from leaks, kinks, or damage, replace primer pump hose (WP 0490).

Step 22. Check tubing from pump prime primer valve fitting to driver main inlet primer valve fitting for leaks, kinks, or damage.

If tubing is free from leaks, kinks, or damage, replace primer hose (WP 0490).

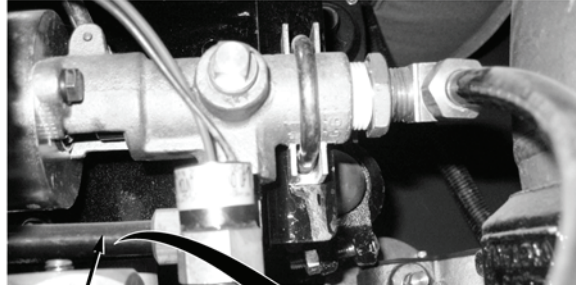
**MALFUNCTION****TEST OR INSPECTION****CORRECTIVE ACTION**

DRIVER MAIN INLET  
PRIMER VALVE TUBING  
TO DRIVER MAIN INLET  
VALVE ASSEMBLY

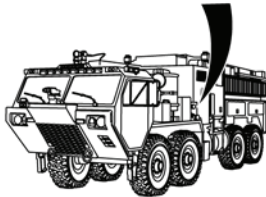

DRIVER MAIN INLET  
VALVE ASSEMBLY

DRIVER MAIN INLET  
PRIMER VALVE TUBING

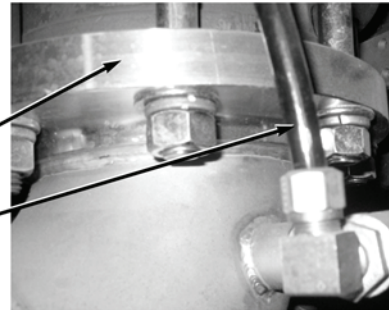

- Step 23. Remove pump house panel C (WP 0540). Check tubing from driver main inlet primer valve fitting to driver main inlet valve assembly for leaks, kinks, or damage.

If tubing is free from leaks, kinks, or damage, replace driver main inlet primer valve tubing (WP 0490).

- Step 24. Remove hard suction hose from driver main inlet (WP 0025). Inspect driver main inlet strainer screen and float for obstructions and blockage.

If screen and float are not free from blockage, remove blockage from driver main inlet strainer screen and float.

- Step 25. Check if hard suction hose is free from holes, leaks, and damage.

If hard suction hose is not free from holes, leaks, and damage, replace hard suction hose.

- Step 26. Prepare vehicle to pump from draft (WP 0025). Check if primer pump is drawing water to water pump.

- a. If hard suction hose coupler is fully seated and not drawing water into water pump, replace primer pump (WP 0262).
- b. If hard suction hose coupler is not fully seated, use rubber mallet to tighten hard suction hose at driver main inlet (WP 0025).

---

**MALFUNCTION**  
**TEST OR INSPECTION**  
**CORRECTIVE ACTION**

---

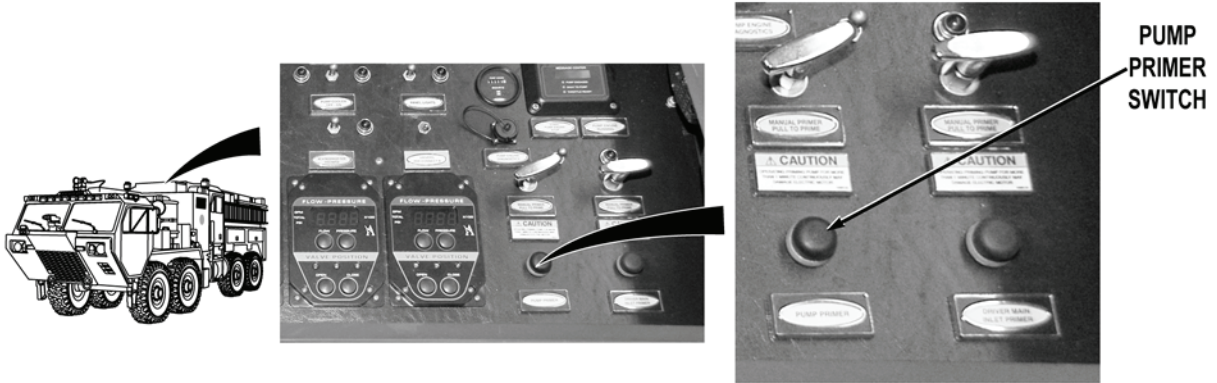

- Step 27. Press pump operator's panel PUMP PRIMER switch (WP 0004). Check for primer pump operation.

If primer pump does not operate when pump operator's panel PUMP PRIMER switch is pressed, go to Step 43.

- Step 28. Push pump operator's panel PUMP PRIMER switch (WP 0004). Check if primer pump draws water to water pump (WP 0025).

If primer pump operates but does not draw water to water pump, go to Step 30.

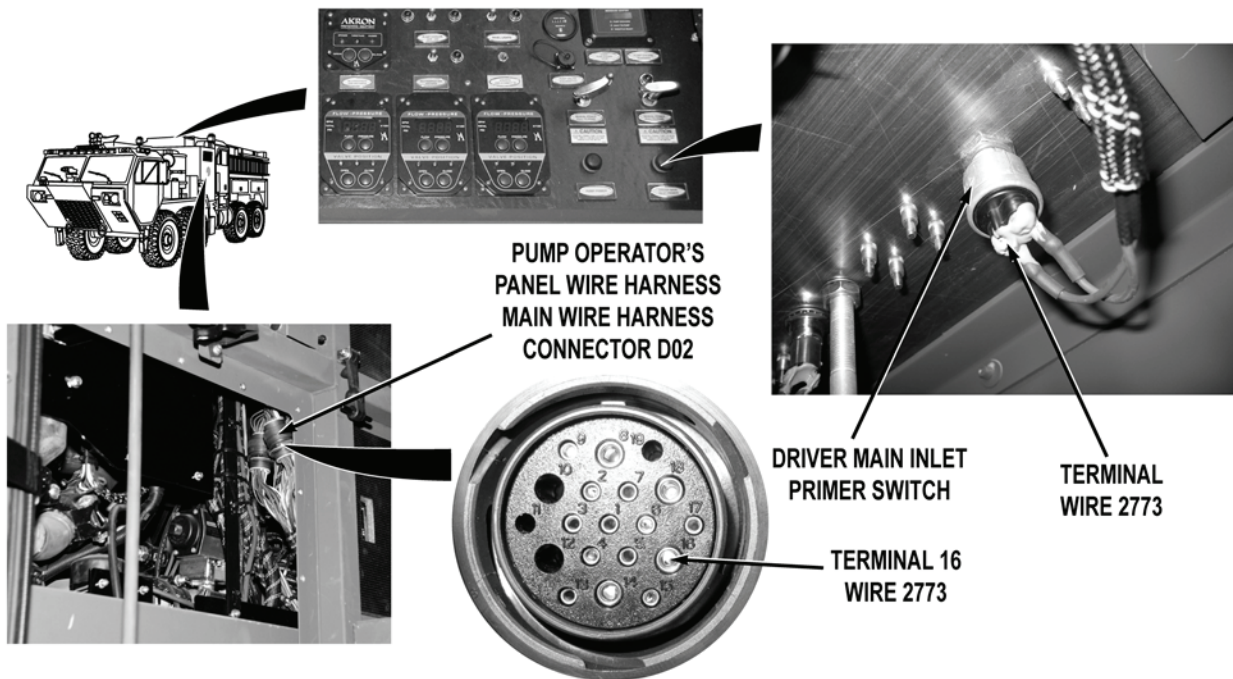
**MALFUNCTION****TEST OR INSPECTION****CORRECTIVE ACTION**

- Step 29. Turn battery disconnect switch to OFF position (WP 0007). Remove driver side crew cab access panel (WP 0499). Remove pump house panel Q (WP 0325). Disconnect pump operator's panel wire harness main wire harness connector DO 2. Check for continuity across wire 2773 (red) from DRIVER MAIN INLET PRIMER switch to pump operator's panel wire harness main wire harness connector DO 2, terminal 16.
- a. If continuity is present, replace pump operator's panel DRIVER MAIN INLET PRIMER switch (WP 0333).
  - b. If continuity is not present, repair wire 2773 in pump operator's panel wire harness if repairable (TM 9-2320-325-14&P), or replace pump operator's panel wire harness (WP 0459).
- Step 30. Prepare vehicle to pump from draft (WP 0025). Pull PUMP PRIMER manual primer cable to closed position (WP 0023). Check if water is drawn to water pump (WP 0025).

If water is not drawn to water pump, go to Step 40.

---

<b>MALFUNCTION</b>	
<b>TEST OR INSPECTION</b>	
	<b>CORRECTIVE ACTION</b>

---

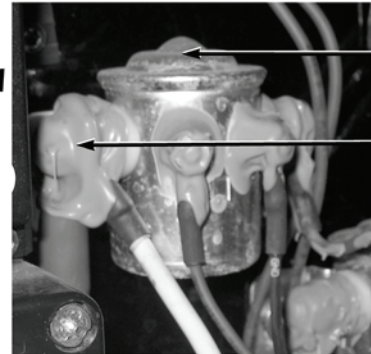

PUMP PRIME PRIMER  
VALVE CONTROL  
SOLENOID

TERMINAL  
6 GAUGE WIRE

### WARNING



**Remove rings, wristwatches, neck chains, and any other jewelry before working around vehicle. Jewelry can catch on equipment and cause serious injury. Jewelry and tools may short across electrical circuits and cause damage to equipment, or severe burns or electrical shock to personnel.**

- Step 31. Open pump house panel A (WP 0539). While an assistant pushes pump operator's panel PUMP PRIMER switch (WP 0004), check if pump prime primer valve control solenoid is operating. Operation can be checked by listening for metallic clicking sound and slight movement of solenoid.

If pump prime primer valve control solenoid does not click and slightly move, go to Step 37.

- Step 32. Check for 22 to 28 VDC between 6 gauge wire at pump prime primer valve control solenoid terminal and a known good ground.

If 22 to 28 VDC are not present, replace 6 gauge wire from pump prime primer valve control solenoid to pump house B+ stud (WP 0393).

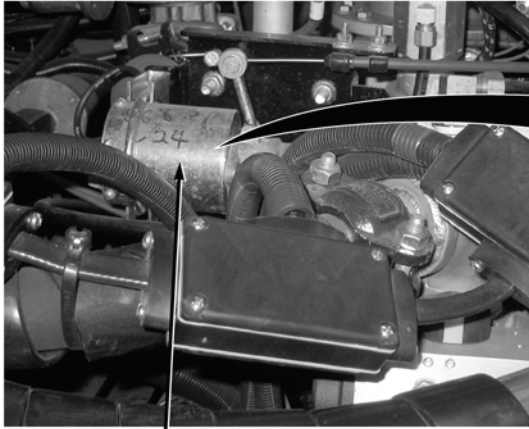
**MALFUNCTION****TEST OR INSPECTION****CORRECTIVE ACTION**

**PUMP PRIME  
PRIMER VALVE**

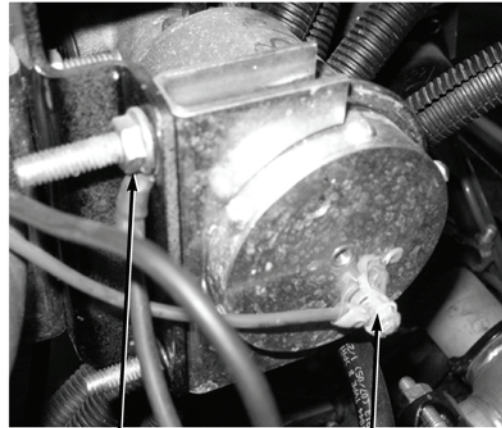

**TERMINAL  
WIRE 4068**

**TERMINAL  
WIRE 4065**

Step 33. While an assistant pushes pump operator's panel PUMP PRIMER switch (WP 0004), check for 22 to 28 VDC between pump house wire harness wire 4065 (red) at pump primer valve and a known good ground.

If 22 to 28 VDC are not present, go to Step 35.

Step 34. Turn battery disconnect switch to OFF position (WP 0007). Disconnect pump house wire harness wire 4068 (black) from pump prime primer valve terminal (WP 0268). Check for continuity across wire 4068 (black) from wire termination to a known good ground.

- a. If continuity is present, replace pump prime primer valve (WP 0267).
- b. If continuity is not present, repair wire 4068 in pump house wire harness if repairable (TM 9-2320-325-14&P), or replace pump house wire harness (WP 0458).

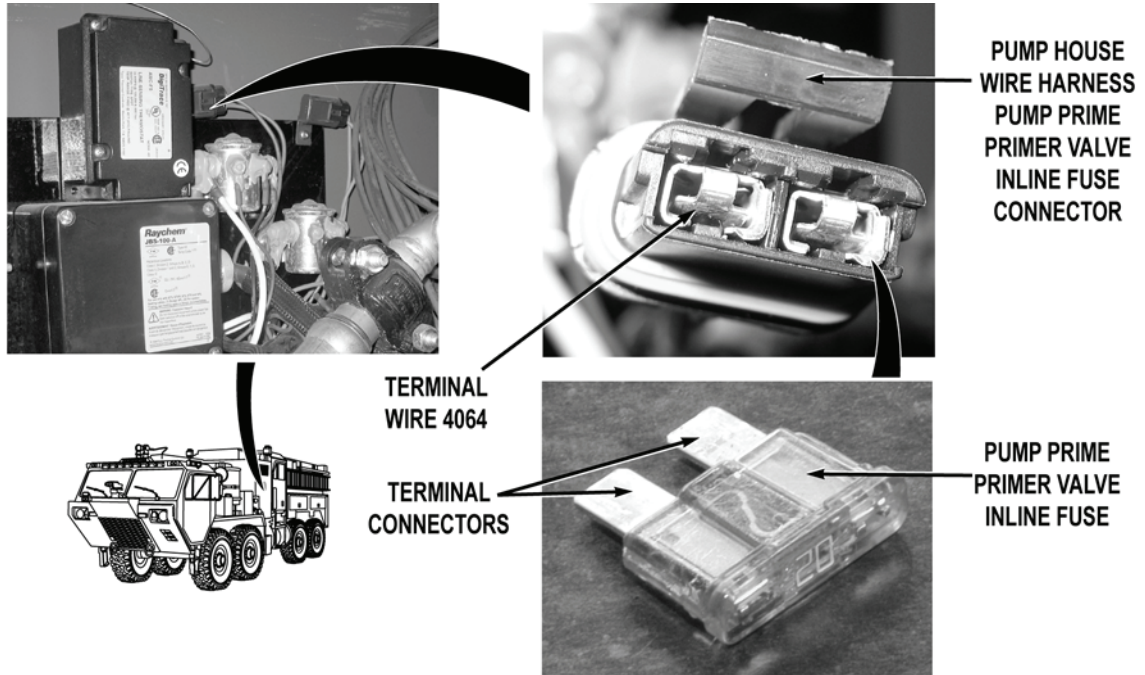
**MALFUNCTION****TEST OR INSPECTION****CORRECTIVE ACTION**

- Step 35. Turn battery disconnect switch to OFF position (WP 0007). Remove pump prime primer valve inline fuse (WP 0261). Turn battery disconnect switch to ON position (WP 0007). While an assistant pushes pump operator's panel PUMP PRIMER switch (WP 0004), check for 22 to 28 VDC between pump house wire harness pump prime primer valve inline fuse holder, terminal wire 4064 (red) and a known good ground.

If 22 to 28 VDC are not present, replace pump primer valve control solenoid (WP 0266).

- Step 36. Check for continuity across pump prime primer valve inline fuse from terminal to terminal.
- a. If continuity is present, repair wire 4065 in pump house wire harness if repairable (TM 9-2320-325-14&P), or replace pump house wire harness (WP 0458).
  - b. If continuity is not present, replace pump prime primer valve inline fuse (WP 0261).

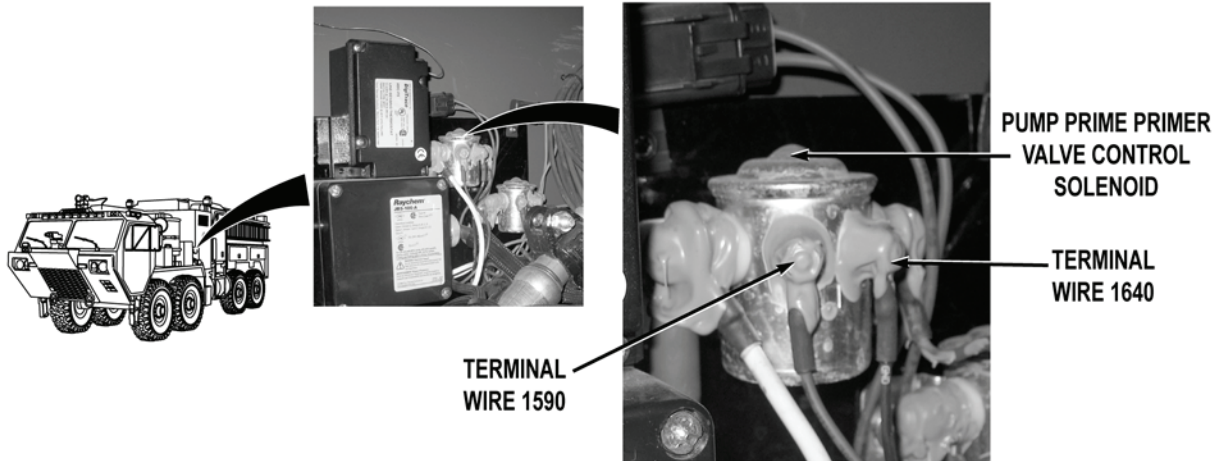
**MALFUNCTION****TEST OR INSPECTION****CORRECTIVE ACTION**

- Step 37. While an assistant pushes and holds pump operator's panel PUMP PRIMER switch to ON position (WP 0004), check for 22 to 28 VDC between pump house wire 1590 (red) at pump prime primer valve control solenoid and a known good ground.

If 22 to 28 VDC are not present, go to Step 39.

- Step 38. Turn battery disconnect switch to OFF position (WP 0007). Check for continuity across pump house wire 1640 (black) from pump prime primer valve control solenoid terminal to a known good ground.
- a. If continuity is present, replace pump prime primer valve control solenoid (WP 0266).
  - b. If continuity is not present, repair wire 1640 in pump house wire harness if repairable (TM 9-2320-325-14&P), or replace pump house wire harness (WP 0458).



**MALFUNCTION****TEST OR INSPECTION****CORRECTIVE ACTION**

PUMP HOUSE WIRE HARNESS  
PUMP OPERATOR'S PANEL  
WIRE HARNESS CONNECTOR



TERMINAL 4  
WIRE 1590

**WARNING**

**Remove rings, wristwatches, neck chains, and any other jewelry before working around vehicle. Jewelry can catch on equipment and cause serious injury. Jewelry and tools may short across electrical circuits and cause damage to equipment, or severe burns or electrical shock to personnel.**

- Step 39. Turn battery disconnect switch to OFF position (WP 0007). Open pump operator's panel housing (WP 0325). Disconnect pump operator's panel wire harness pump house wire harness connector. Turn battery disconnect switch to ON position (WP 0007). While an assistant pushes pump operator's panel PUMP PRIME switch (WP 0004), check for 22 to 28 VDC between pump operator's panel wire harness wire 1590 (red) at pump operator's panel wire harness pump house wire harness connector, terminal 4 and a known good ground.
- a. If 22 to 28 VDC are present, repair wire 1590 in pump house wire harness if repairable (TM 9-2320-325-14&P), or replace pump house wire harness (WP 0458).
  - b. If 22 to 28 VDC are not present, repair wire 1590 in pump operator's panel wire harness if repairable (TM 9-2320-325-14&P), or replace pump operator's panel wire harness (WP 0459).

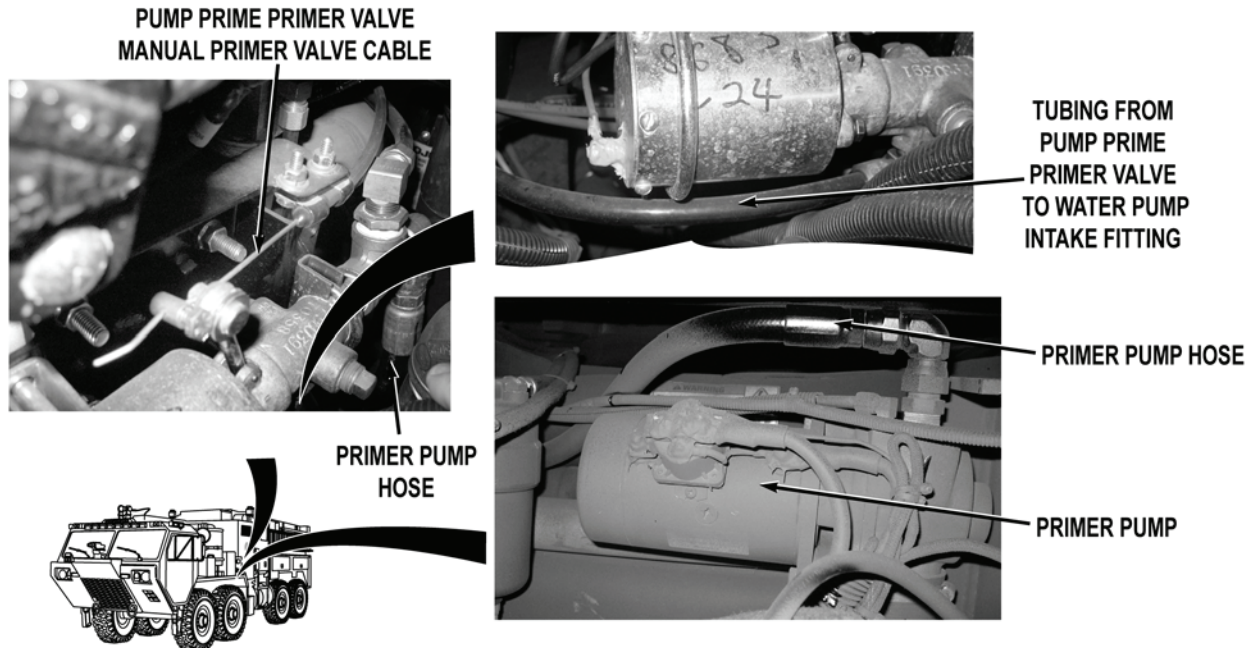
**MALFUNCTION****TEST OR INSPECTION****CORRECTIVE ACTION**

Step 40. Open pump house panel A (WP 0539). Check pump prime primer valve manual primer cable for binding and damage.

If pump prime primer valve manual primer cable is binding or damaged, replace pump prime primer valve manual primer cable (WP 0265).

Step 41. Check primer pump hose from primer pump to pump prime primer valve fitting for leaks, kinks, or damage.

If primer pump hose is not free from leaks, kinks, or damage, replace primer pump hose (WP 0490).

Step 42. Check tubing from pump prime primer valve fitting to water pump intake fitting (WP 0490) for leaks, kinks, or damage.

- a. If tubing is free from leaks, kinks, or damage, replace primer pump (WP 0262).
- b. If tubing is not free from leaks, kinks, or damage, replace tubing (WP 0490).

**MALFUNCTION**  
**TEST OR INSPECTION**  
**CORRECTIVE ACTION**

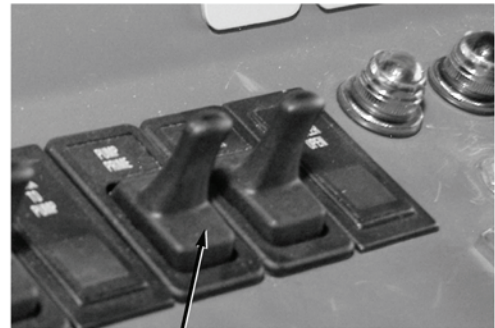
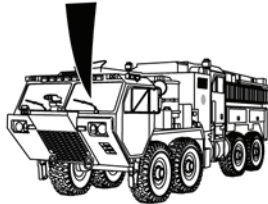

**PERSONNEL CAB  
PUMP PRIME SWITCH**

Step 43. Press personnel cab PUMP PRIME switch to on position (WP 0004). Check for primer pump operation.

If primer pump does not operate when personnel cab PUMP PRIME switch is pressed, go to Step 61.

Step 44. Put personnel cab PUMP PRIME switch to on position (WP 0004). Check if primer pump draws water to water pump.

If primer pump operates but does not draw water to water pump, go to Step 48.



**TERMINAL  
WIRE 1590**

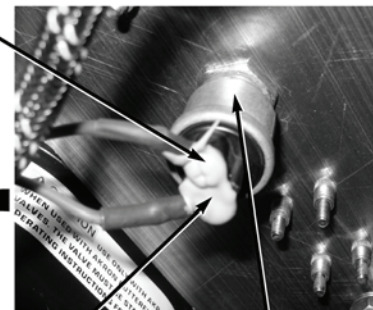

**TERMINAL  
WIRE 2773**

**PUMP OPERATOR'S PANEL  
PUMP PRIMER SWITCH**

Step 45. Turn battery disconnect switch to OFF position (WP 0007). Open pump operator's panel housing (WP 0325). While an assistant pushes and holds pump operator's panel PUMP PRIMER switch to on position (WP 0004), check for continuity across pump operator's panel PUMP PRIMER switch from wire 2773 terminal to wire 1590 terminal.

If continuity is not present, replace pump operator's panel PUMP PRIMER switch (WP 0333).

**MALFUNCTION**

**TEST OR INSPECTION**

**CORRECTIVE ACTION**

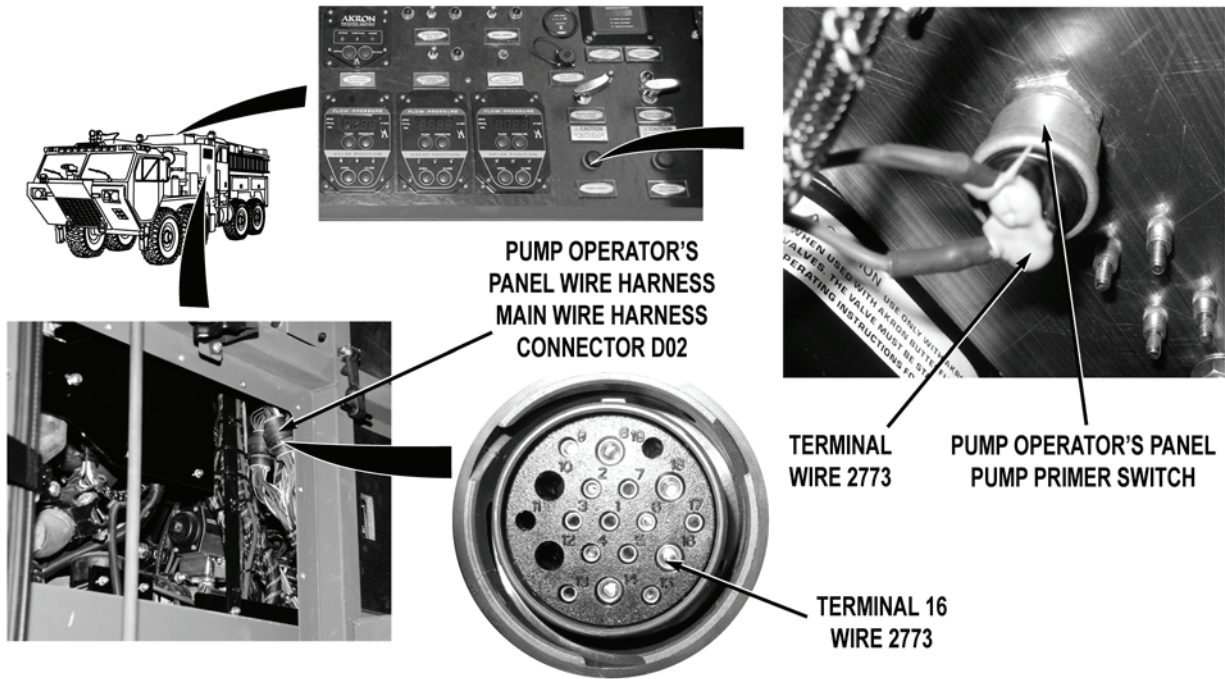

Step 46. Remove driver side crew cab access panel (WP 0499). Remove pump house panel Q (WP 0325). Disconnect pump operator's panel wire harness main wire harness connector DO 2. With a test lead set, check for continuity across pump operator's panel wire harness wire 2773 (red) from pump operator's panel PUMP PRIMER switch terminal to pump operator's panel wire harness main wire harness connector DO 2, terminal 16.

If continuity is not present, repair wire 2773 in pump operator's panel wire harness if repairable (TM 9-2320-325-14&P), or replace pump operator's panel wire harness (WP 0459).

---

**MALFUNCTION**  
**TEST OR INSPECTION**  
**CORRECTIVE ACTION**

---

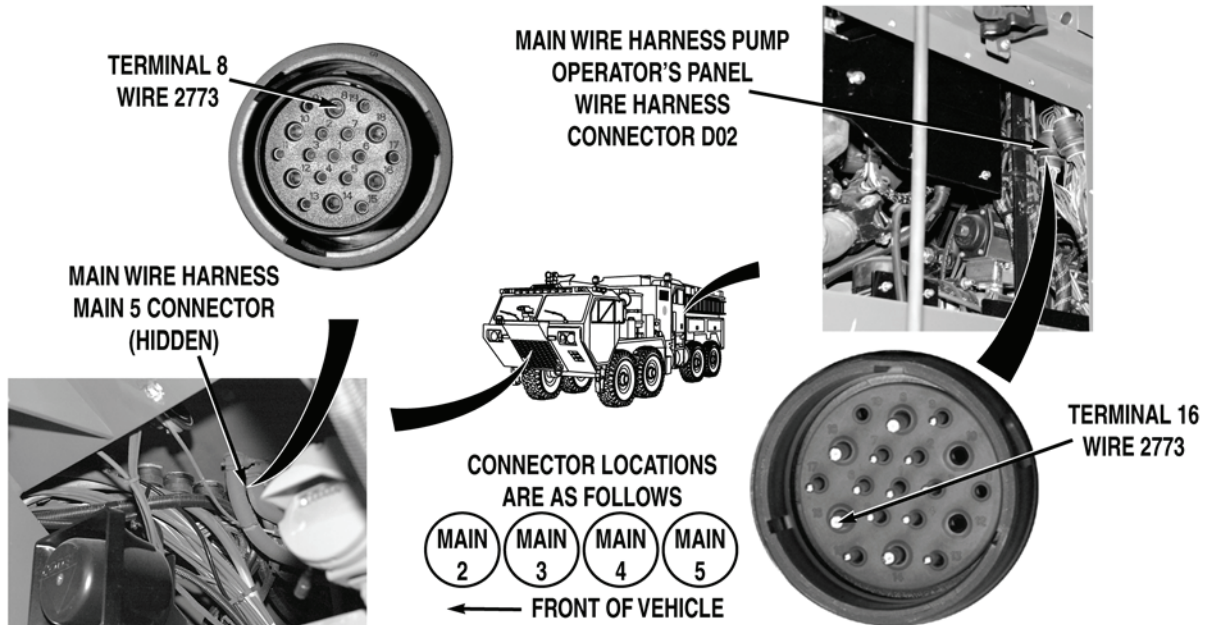

- Step 47. Remove skid plate grille (WP 0550). Disconnect main wire harness main 5 connector. With a test lead set, check for continuity across main wire harness wire 2773 (red), from main wire harness main 5 connector, terminal 8 to main wire harness pump operator's panel wire harness connector DO 2, terminal 16.
- If continuity is present, repair wire 2773 in pump control wire harness if repairable (TM 9-2320-325-14&P), or replace cab pump control wire harness (WP 0443).
  - If continuity is not present, repair wire 2773 in main wire harness if repairable (TM 9-2320-325-14&P), or replace main wire harness (WP 0455).
- Step 48. Prepare vehicle to pump from draft (WP 0025). Pull PUMP PRIME manual priming cable to closed position (WP 0023). Check if water is drawn to water pump (WP 0025).
- If water is not drawn to water pump, go to Step 58.

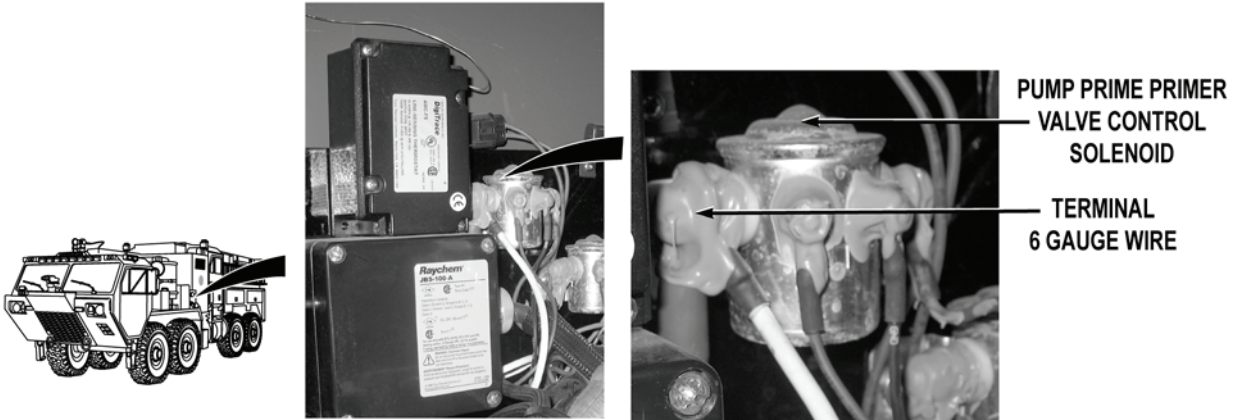
**MALFUNCTION****TEST OR INSPECTION****CORRECTIVE ACTION**

- Step 49. Open pump house panel A (WP 0539). While an assistant puts pump operator's panel PUMP PRIMER switch to on position (WP 0004), check if pump prime primer valve control solenoid is operating. Operation can be checked by listening for metallic clicking sound and slight movement of solenoid.

If pump prime valve control solenoid does not click and slightly move, go to Step 53.

**WARNING**

**Remove rings, wristwatches, neck chains, and any other jewelry before working around vehicle. Jewelry can catch on equipment and cause serious injury. Jewelry and tools may short across electrical circuits and cause damage to equipment, or severe burns or electrical shock to personnel.**

- Step 50. Check for 22 to 28 VDC between 6 gauge wire at pump prime primer valve control solenoid terminal and known good ground.

If 22 to 28 VDC are not present, replace 6 gauge wire from pump prime primer valve control solenoid to pump house B+ stud (WP 0393).

---

<b>MALFUNCTION</b>	<b>TEST OR INSPECTION</b>	<b>CORRECTIVE ACTION</b>
--------------------	---------------------------	--------------------------

---

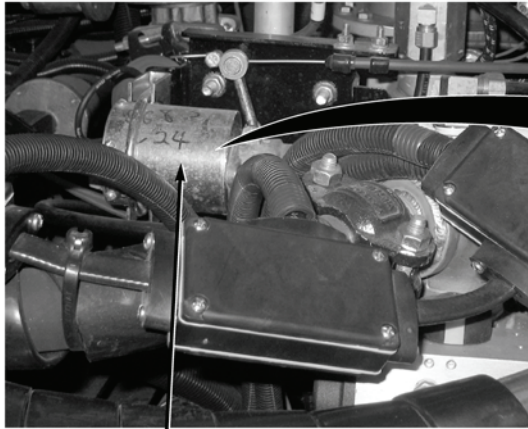

PUMP PRIME  
PRIMER VALVE

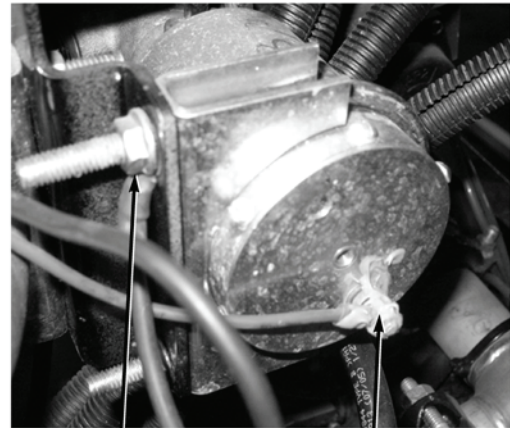

TERMINAL  
WIRE 4068

TERMINAL  
WIRE 4065

- Step 51. While an assistant pushes pump operator's panel PUMP PRIME switch (WP 0004), check for 22 to 28 VDC between pump house wire harness wire 4065 (red) at pump prime primer valve and a known good ground.

If 22 to 28 VDC are not present, go to Step 53.

- Step 52. Turn battery disconnect switch to OFF position (WP 0007). Disconnect pump house wire harness wire 4068 (black) from pump prime valve terminal (WP 0267). Check for continuity across 4068 (black) from wire termination to a known good ground.
- a. If continuity is present, replace pump prime valve (WP 0267).
  - b. If continuity is not present, repair 4068 in pump house wire harness if repairable (TM 9-2320-325-14&P), or replace pump house wire harness (WP 0458).

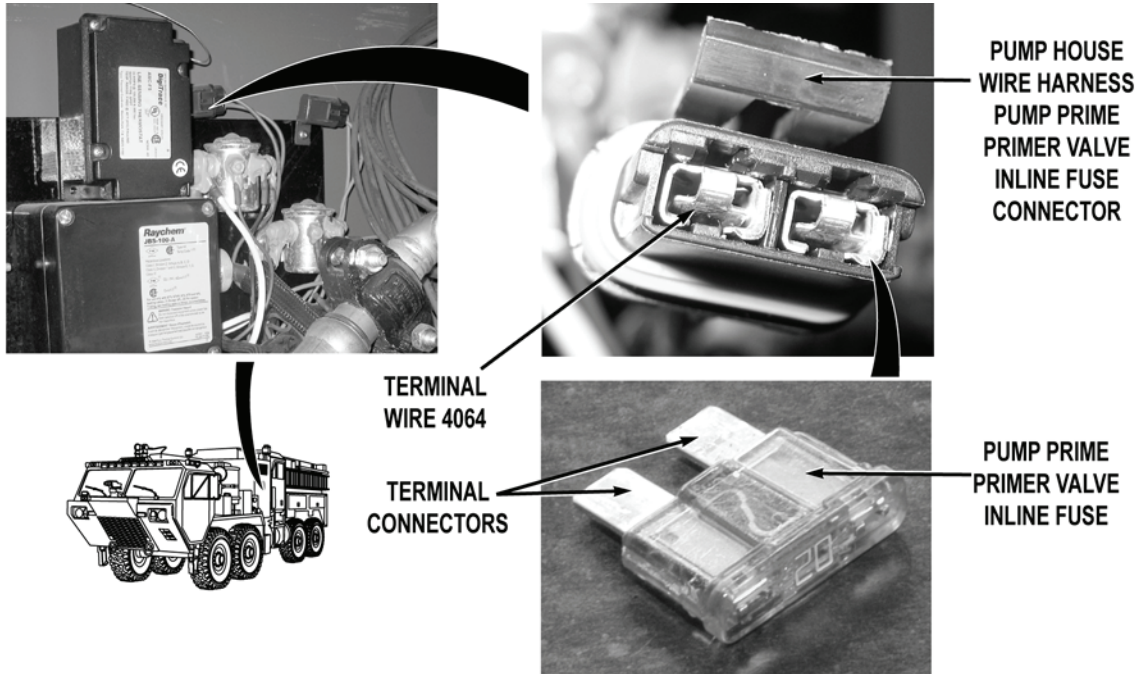
**MALFUNCTION****TEST OR INSPECTION****CORRECTIVE ACTION**

- Step 53. Turn battery disconnect switch to OFF position (WP 0007). Remove pump prime primer valve inline fuse (WP 0261). Turn battery disconnect switch to ON position (WP 0007). While an assistant pushes pump operator's panel PUMP PRIMER switch (WP 0004), check for 22 to 28 VDC between pump house wire harness pump prime primer valve inline fuse connector, wire 4064 (red) and a known good ground.

If 22 to 28 VDC are not present, replace pump prime primer valve control solenoid (WP 0266).

- Step 54. Check for continuity across pump prime valve inline fuse from terminal to terminal.
- a. If continuity is present, repair wire 4065 in pump house wire harness if repairable (TM 9-2320-325-14&P), or replace pump house wire harness (WP 0458).
  - b. If there is no continuity present, replace pump prime primer valve inline fuse (WP 0261).

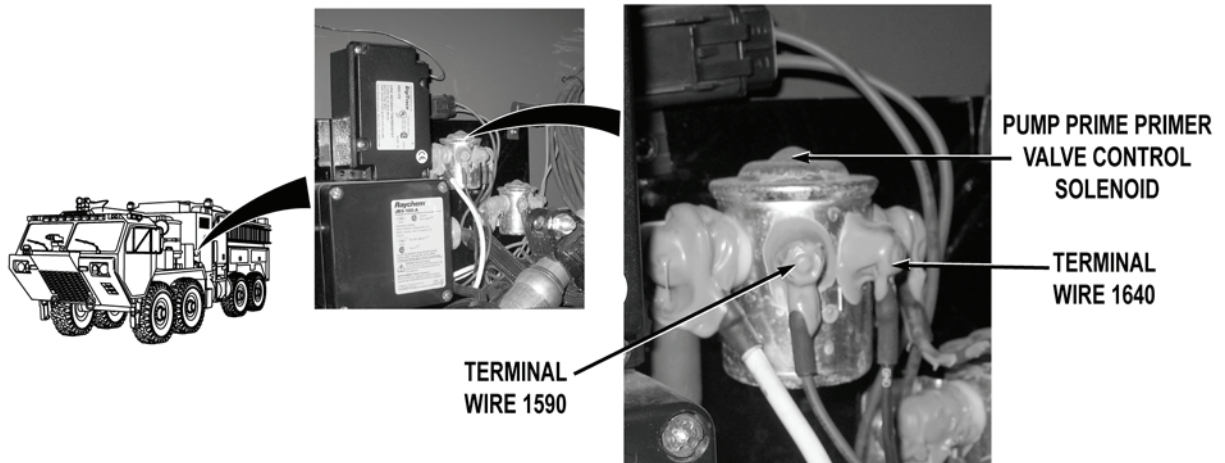

**MALFUNCTION****TEST OR INSPECTION****CORRECTIVE ACTION**

Step 55. While an assistant puts and holds pump operator's panel PUMP PRIMER switch to on position (WP 0004), check for 22 to 28 VDC between pump house wire harness wire 1590 (red) at pump prime primer valve control solenoid and a known good ground.

If 22 to 28 VDC are not present, go to Step 57.

Step 56. Turn battery disconnect switch to OFF position (WP 0007). Check for continuity across pump house wire harness wire 1640 (black) from pump prime primer valve control solenoid terminal to a known good ground.

- a. If continuity is present, replace pump prime primer valve control solenoid (WP 0266).
- b. If continuity is not present, repair wire 1640 in pump house wire harness if repairable (TM 9-2320-325-14&P), or replace wire harness (WP 0458).

**MALFUNCTION****TEST OR INSPECTION****CORRECTIVE ACTION**

PUMP HOUSE WIRE HARNESS  
PUMP OPERATOR'S PANEL  
WIRE HARNESS CONNECTOR

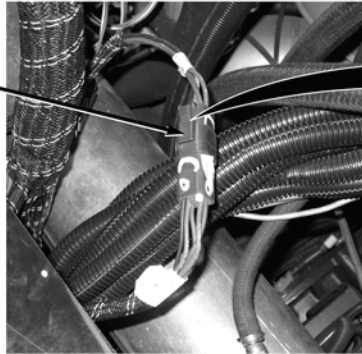

TERMINAL 4  
WIRE 1590

**WARNING**

**Remove rings, wristwatches, neck chains, and any other jewelry before working around vehicle. Jewelry can catch on equipment and cause serious injury. Jewelry and tools may short across electrical circuits and cause damage to equipment, or severe burns or electrical shock to personnel.**

- Step 57. Turn battery disconnect switch to OFF position (WP 0007). Open pump operator's panel housing (WP 0325). Disconnect pump operator's panel wire harness pump house wire harness connector. Turn battery disconnect switch to ON position (WP 0007). While an assistant pushes pump operator's panel PUMP PRIME switch (WP 0004), check for 22 to 28 VDC across pump operator's panel wire harness wire 1590 (red) at pump operator's panel wire harness pump house wire harness connector, terminal 4 and a known good ground.
- a. If 22 to 28 VDC are present, repair wire 1590 in pump house wire harness if repairable (TM 9-2320-325-14&P), or replace pump house wire harness (WP 0458).
  - b. If 22 to 28 VDC are not present, repair wire 1590 in pump operator's panel wire harness if repairable (TM 9-2320-325-14&P), or replace pump operator's panel wire harness (WP 0459).

**MALFUNCTION**

**TEST OR INSPECTION**

**CORRECTIVE ACTION**

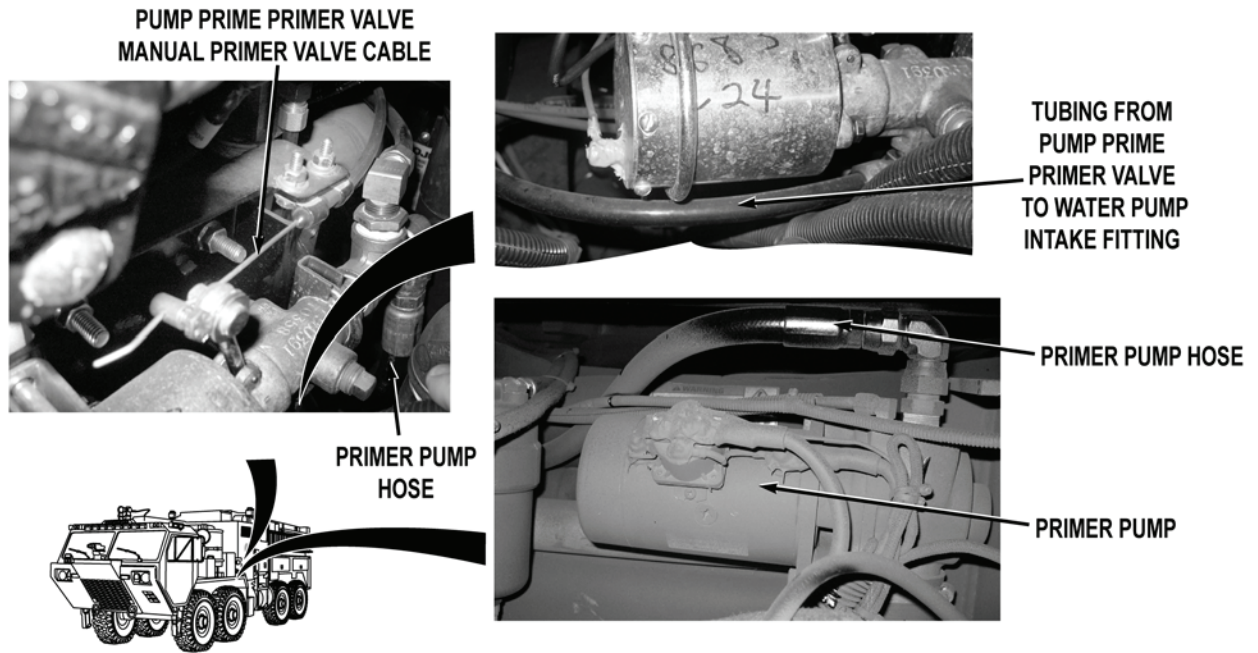

- Step 58. Open pump house panel A (WP 0539). Check pump prime primer valve manual primer cable for binding and damage.
- If pump prime manual primer cable is binding or damaged, replace pump prime primer valve manual primer cable (WP 0265).
- Step 59. Check primer pump hose from primer pump to pump prime valve fitting for leaks, kinks, or damage.
- If primer pump hose is not free from leaks, kinks, or damage, replace primer pump hose (WP 0490).
- Step 60. Check tubing from pump prime valve fitting to pump intake fitting for leaks, kinks, or damage.
- a. If tubing is free from leaks, kinks, or damage, replace primer pump (WP 0262).
  - b. If tubing is not free from leaks, kinks, or damage, replace tubing (WP 0490).

**MALFUNCTION**

**TEST OR INSPECTION**

**CORRECTIVE ACTION**

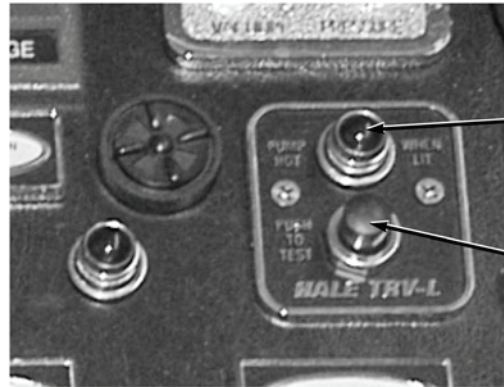
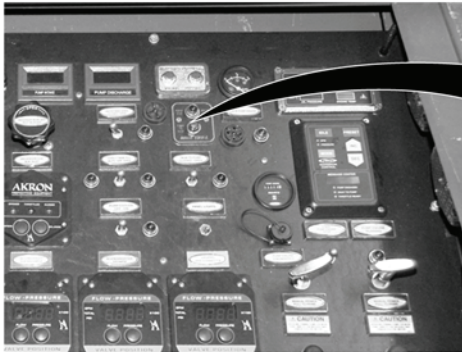

PUMP HOT  
INDICATOR

PUMP HOT  
PUSH TO  
TEST SWITCH



Step 61. Press pump operator's panel PUMP HOT PUSH TO TEST button (WP 0004). Check if PUMP HOT indicator illuminates (WP 0004).

If PUMP HOT indicator does not illuminate, go to Step 77.

---

**MALFUNCTION**  
**TEST OR INSPECTION**  
**CORRECTIVE ACTION**

---

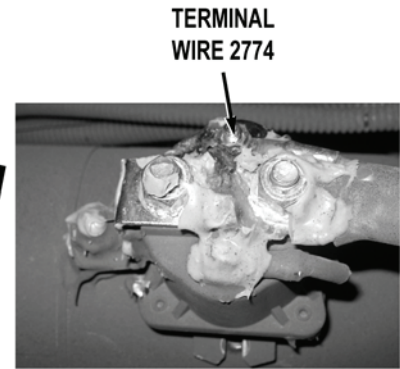
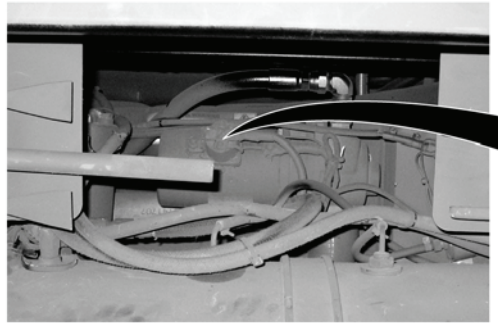

**WARNING**



**Remove rings, wristwatches, neck chains, and any other jewelry before working around vehicle. Jewelry can catch on equipment and cause serious injury. Jewelry and tools may short across electrical circuits and cause damage to equipment, or severe burns or electrical shock to personnel.**

- Step 62. While an assistant pushes and holds pump operator's panel DRIVER MAIN INLET PRIMER switch (WP 0004), check for 22 to 28 VDC between main wire harness wire 2774 (red) at primer pump motor solenoid terminal and a known good ground.

If 22 to 28 VDC are not present, go to Step 73.

**MALFUNCTION**

**TEST OR INSPECTION**

**CORRECTIVE ACTION**

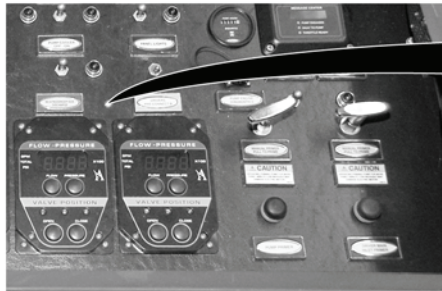

**PUMP PRIMER  
MOTOR DIODE PACK**



**PUMP OPERATOR'S  
PANEL WIRE HARNESS  
PUMP PRIMER MOTOR  
DIODE PACK CONNECTOR**

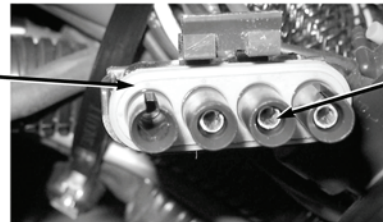

**TERMINAL C  
WIRE 2788**

Step 63. Open pump operator's panel housing (WP 0325). Remove pump primer motor diode pack from pump operator's panel wire harness pump primer motor diode pack connector (WP 0419). While an assistant puts pump operator's panel DRIVER MAIN INLET PRIMER switch to on position (WP 0004), with a test lead set, check for 22 to 28 VDC between pump operator's panel wire harness wire 2788 (blue) at pump primer motor diode pack connector terminal C, and a known good ground.

If 22 to 28 VDC are not present, go to Step 72.

---

<b>MALFUNCTION</b>	<b>TEST OR INSPECTION</b>	<b>CORRECTIVE ACTION</b>
--------------------	---------------------------	--------------------------

---

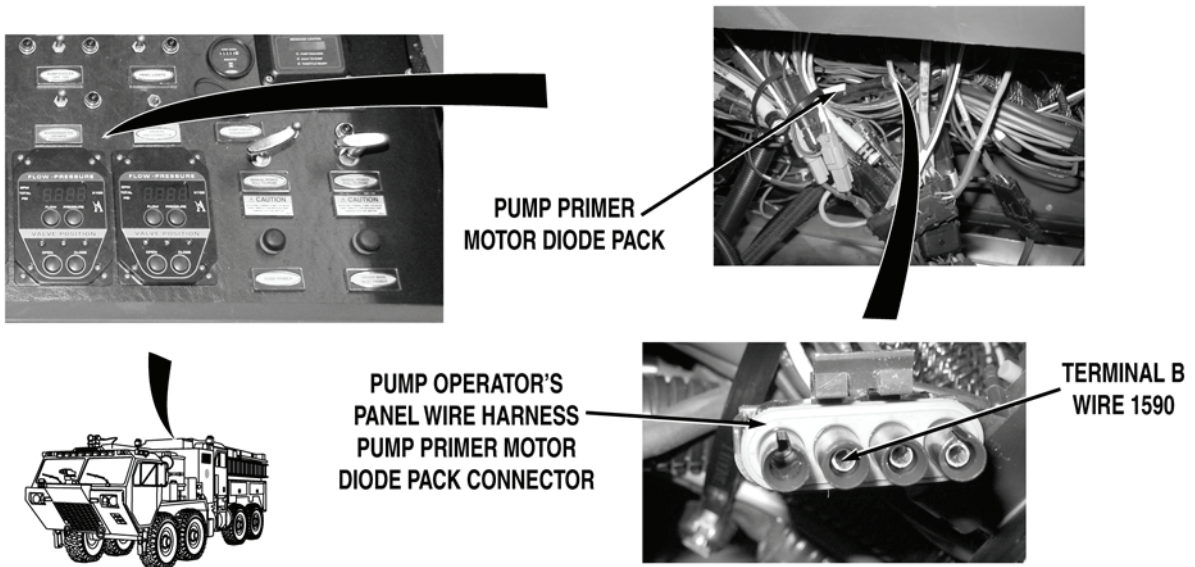

- Step 64. While an assistant pushes pump operator's panel PUMP PRIMER switch to on position (WP 0004), with a test lead set, check for 22 to 28 VDC between pump operator's panel wire harness wire 1590 (red) at pump primer motor diode pack connector, terminal B and a known good ground.

If 22 to 28 VDC are not present, go to Step 71.

- Step 65. While an assistant puts personnel cab PUMP PRIME switch to on position (WP 0004), with a test lead set, check for 22 to 28 VDC between pump operator's panel wire harness wire 1590 (red) at pump primer motor diode pack connector, terminal B and a known good ground.

If 22 to 28 VDC are not present, go to Step 68.

**MALFUNCTION**

**TEST OR INSPECTION**

**CORRECTIVE ACTION**

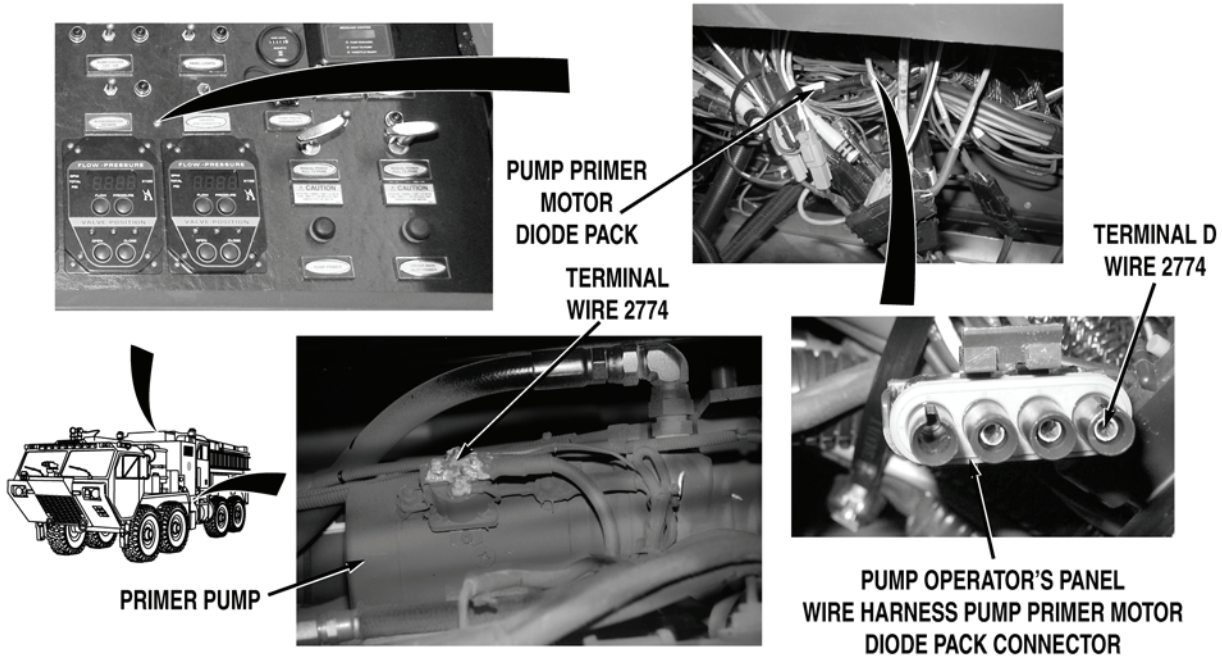

Step 66. Turn battery disconnect switch to OFF position (WP 0007). With a test lead set, check for continuity across wire 2774 from pump operator's panel wire harness pump primer motor diode pack connector, terminal D to pump house wire harness primer pump motor control solenoid terminal.

If continuity is present, replace pump primer motor diode pack (WP 0419).



**MALFUNCTION**  
**TEST OR INSPECTION**  
**CORRECTIVE ACTION**

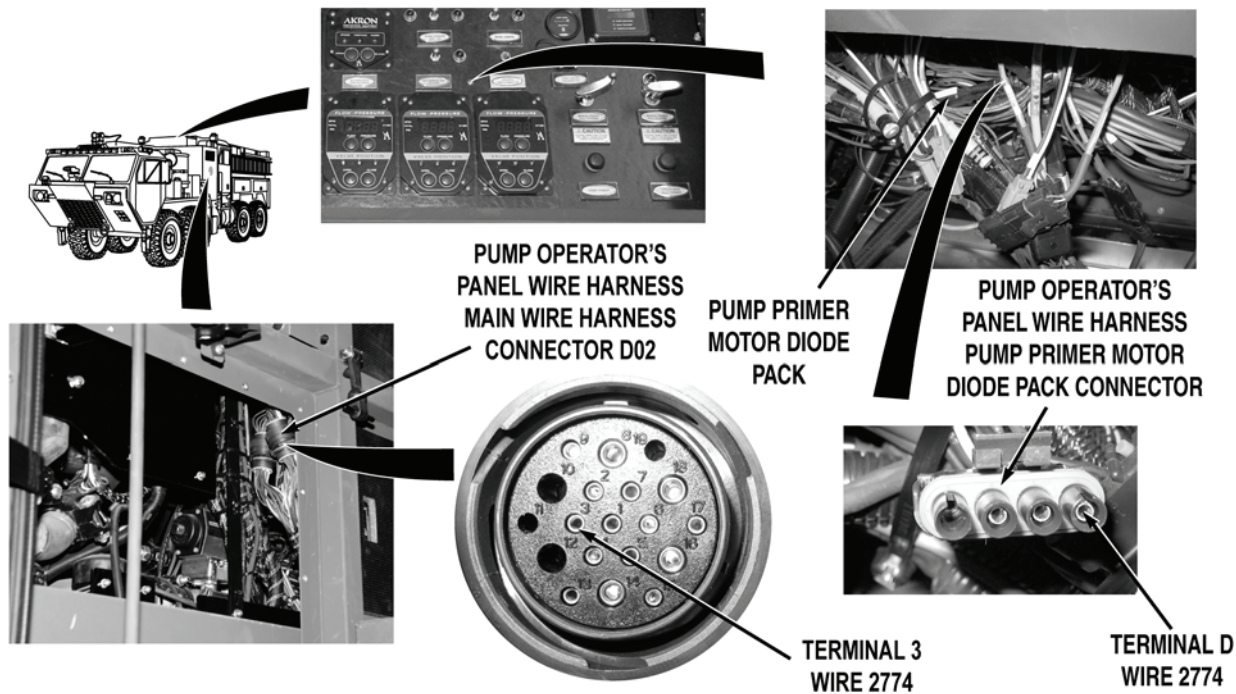

- Step 67. Turn battery disconnect switch to OFF position (WP 0007). Remove driver side crew cab access panel (WP 0499). Remove pump house panel Q (WP 0325). Disconnect pump operator's panel wire harness main wire harness connector DO 2. With a test lead set, check for continuity across wire 2774 (red) from pump operator's panel wire harness pump primer motor diode pack connector, terminal D to pump operator's panel wire harness main wire harness connector DO 2, terminal 3.
- a. If continuity is present, repair wire 2774 in main wire harness if repairable (TM 9-2320-325-14&P), or replace main wire harness (WP 0455).
  - b. If continuity is not present, repair wire 2774 in pump operator's panel wire harness if repairable (TM 9-2320-325-14&P), or replace pump operator's panel wire harness (WP 0459).

**MALFUNCTION**

**TEST OR INSPECTION**

**CORRECTIVE ACTION**

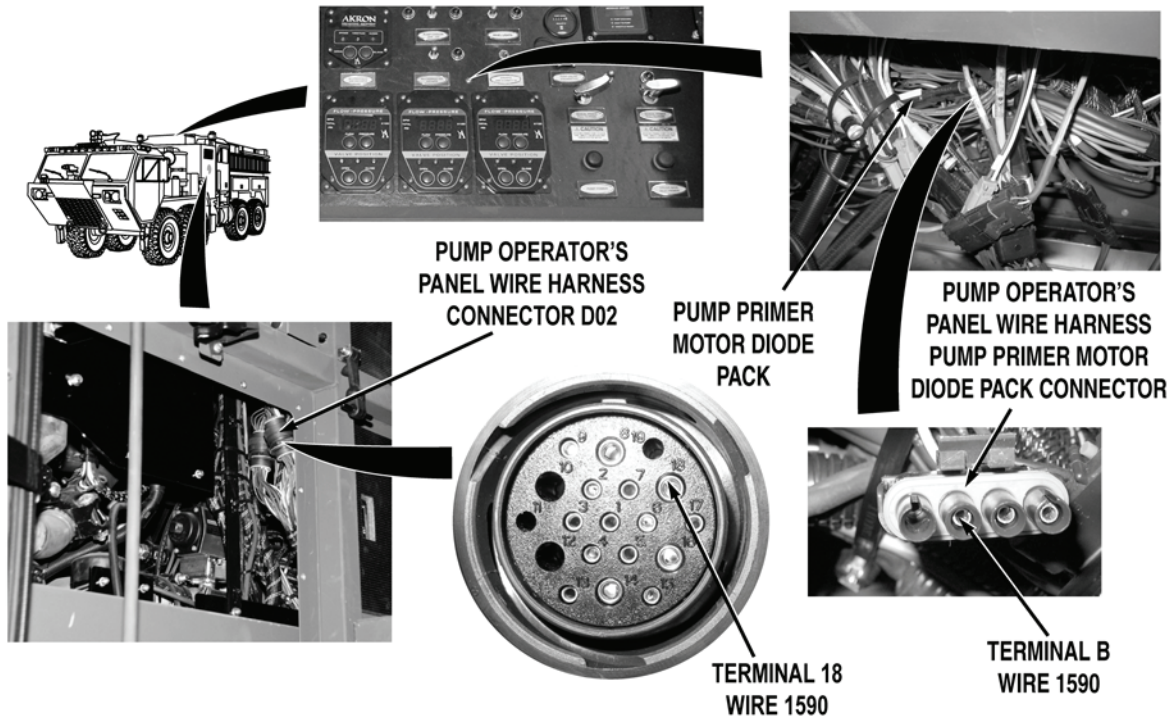

Step 68. Turn battery disconnect switch to OFF position (WP 0007). Remove driver side crew cab access panel (WP 0499). Remove pump house panel Q (WP 0325). Disconnect pump operator's panel wire harness main wire harness connector DO 2. With a test lead set, check for continuity across pump operator's panel wire 1590 (red) from pump operator's panel primer pump motor diode connector, terminal B, to pump operator's panel wire harness main wire harness connector DO 2, terminal 18.

If continuity is not present, repair wire 1590 in pump operator's panel wire harness if repairable (TM 9-2320-325-14&P), or replace pump operator's panel wire harness (WP 0459).

**MALFUNCTION**  
**TEST OR INSPECTION**  
**CORRECTIVE ACTION**

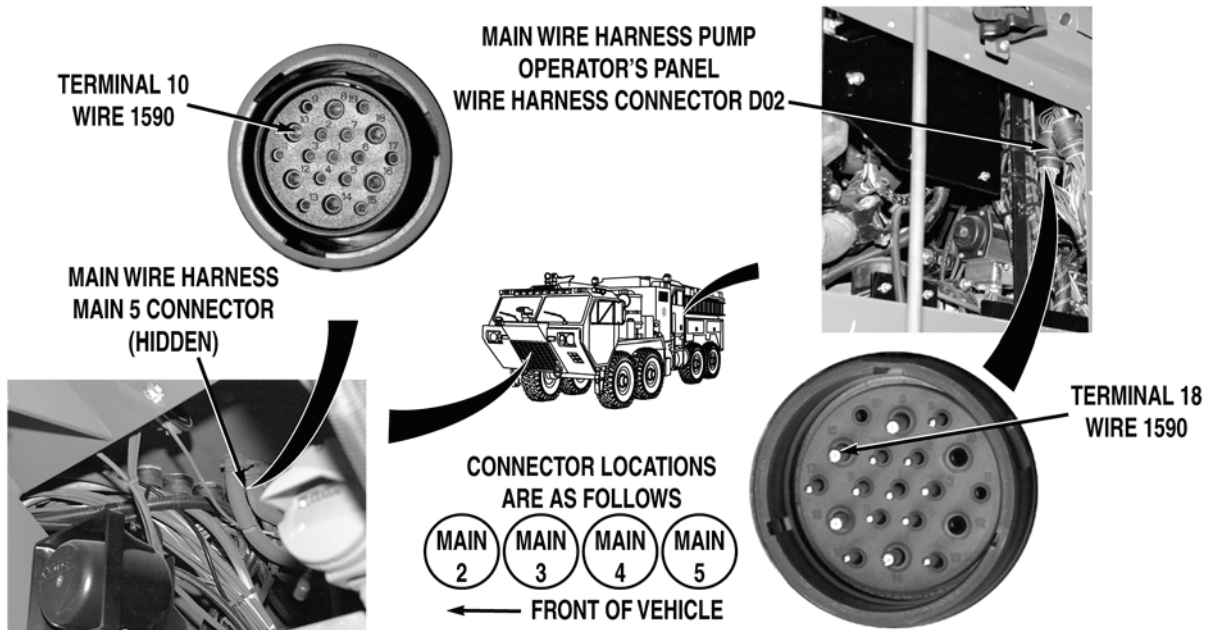

Step 69. Remove skid plate grille (WP 0550). Disconnect main wire harness main 5 wire harness connector. With a test lead set, check for continuity across main wire harness wire 1590 (red), from main wire harness main 5 connector, terminal 10 to main wire harness pump operator's panel wire harness connector DO 2, terminal 18.

If continuity is not present, repair wire 1590 in main wire harness if repairable (TM 9-2320-325-14&P), or replace main wire harness (WP 0455).

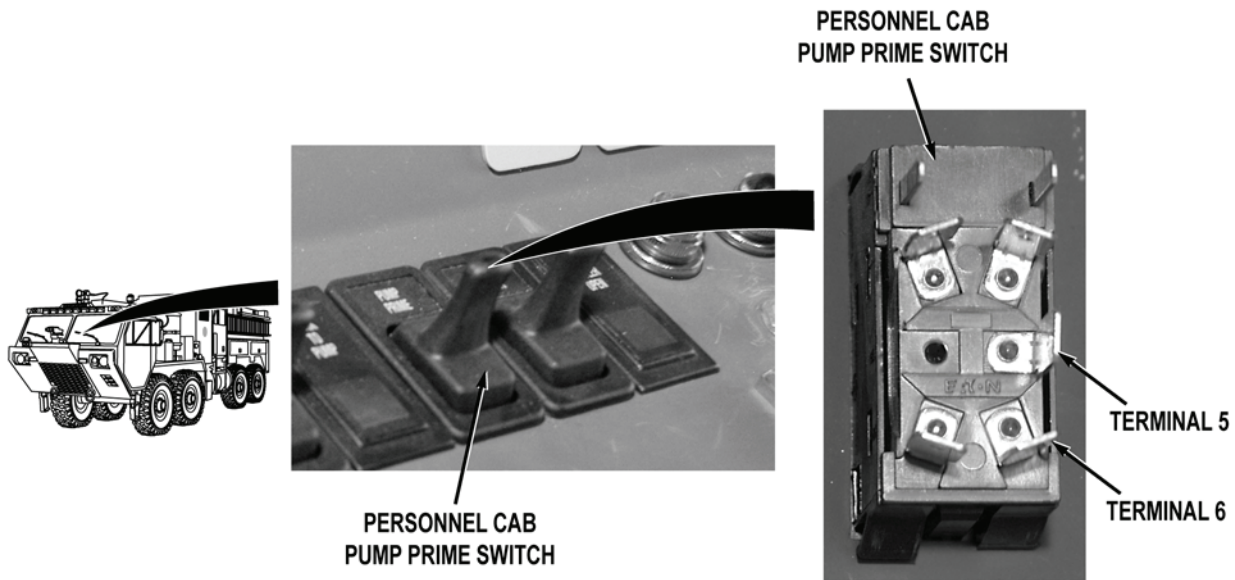
**MALFUNCTION****TEST OR INSPECTION****CORRECTIVE ACTION**

- Step 70. Remove personnel cab instrument panel B (WP 0311). Disconnect cab pump control wire harness PUMP PRIME switch connector. While an assistant puts personnel cab PUMP PRIME switch to on position (WP 0004), check for continuity across PUMP PRIME switch from terminal 5 to terminal 6.
- a. If continuity is present, repair wire 1590 in cab pump control wire harness if repairable (TM 9-2320-325-14&P), or replace cab pump control wire harness (WP 0443).
  - b. If continuity is not present, replace personnel cab PUMP PRIME switch (WP 0315).

---

<b>MALFUNCTION</b>	<b>TEST OR INSPECTION</b>	<b>CORRECTIVE ACTION</b>
--------------------	---------------------------	--------------------------

---

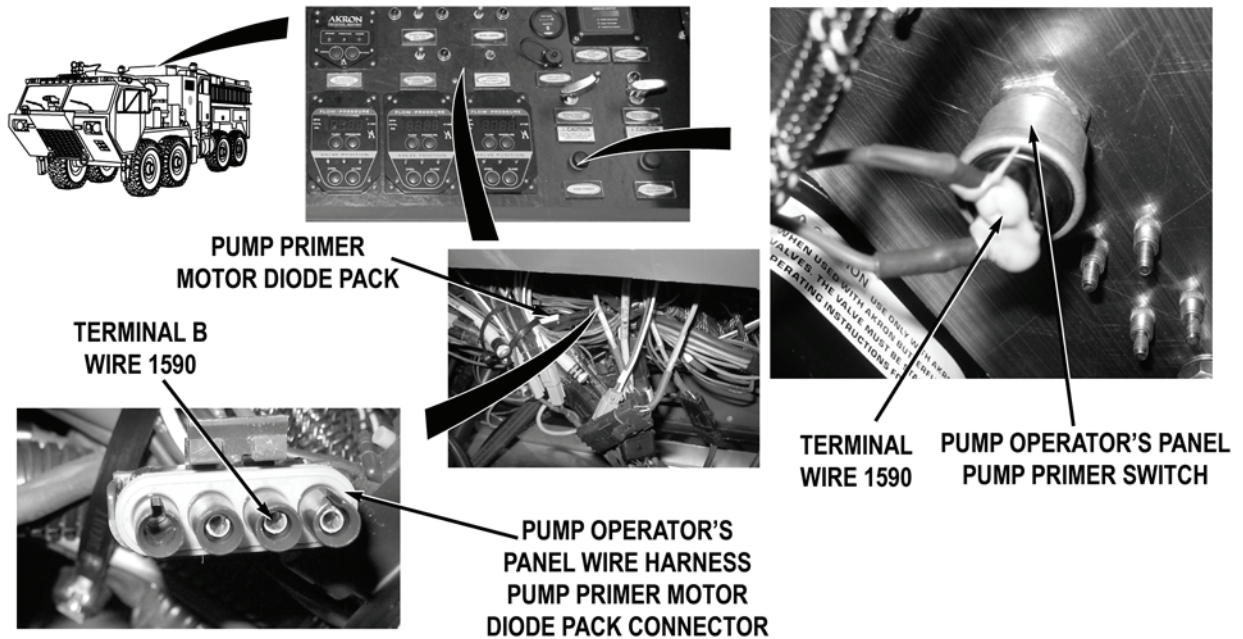

- Step 71. Turn battery disconnect switch to OFF position (WP 0007). With a test lead set, check for continuity across pump operator's panel wire 1590 (red) from pump operator's panel wire harness pump primer motor diode pack connector, terminal B to pump operator's panel PUMP PRIMER switch.
- a. If continuity is present, replace pump operator's panel PUMP PRIMER switch (WP 0333).
  - b. If continuity is not present, repair wire 1590 in pump operator's panel wire harness if repairable (TM 9-2320-325-14&P), or replace pump operator's panel wire harness (WP 0459).

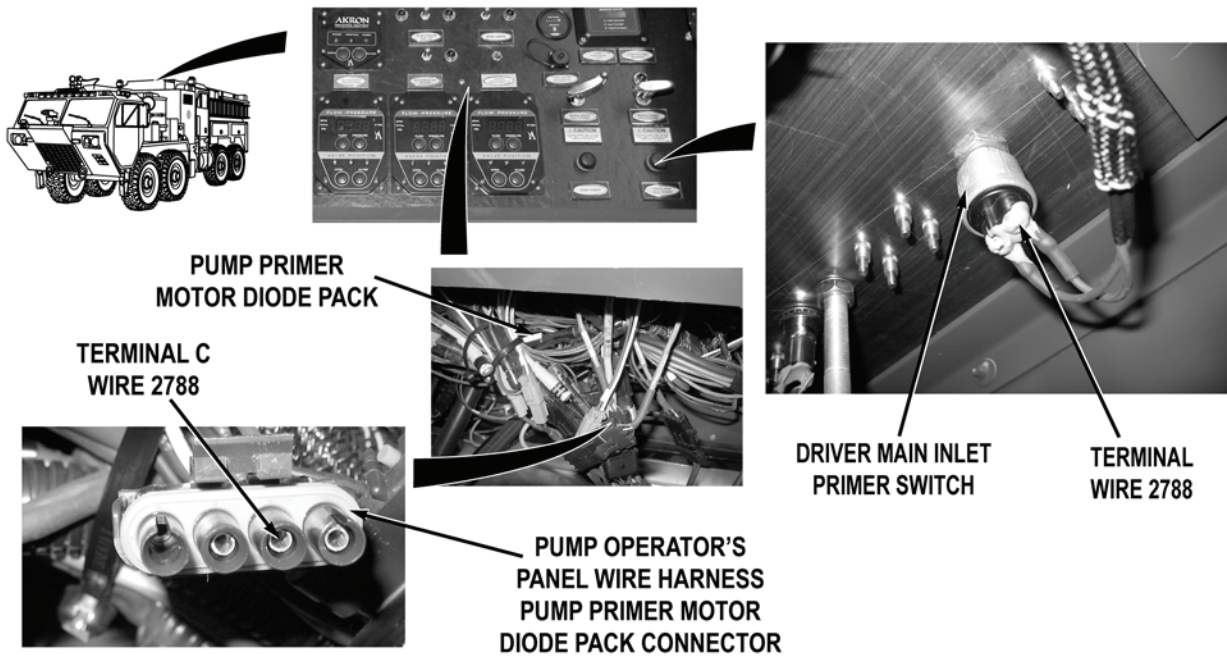
**MALFUNCTION****TEST OR INSPECTION****CORRECTIVE ACTION**

- Step 72. Turn battery disconnect switch to OFF position (WP 0007). With a test lead set, check for continuity across pump operator's panel wire 2788 (blue) from pump operator's panel wire harness pump primer motor diode pack connector, terminal C to pump operator's panel DRIVER MAIN INLET PRIMER switch.
- a. If continuity is present, replace pump operator's panel DRIVER MAIN INLET PRIMER switch (WP 0333).
  - b. If continuity is not present, repair wire 2788 in pump operator's panel wire harness if repairable (TM 9-2320-325-14&P), or replace pump operator's panel wire harness (WP 0459).

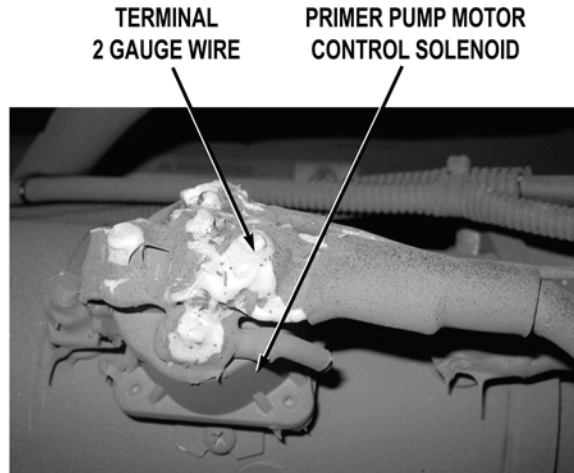
**MALFUNCTION****TEST OR INSPECTION****CORRECTIVE ACTION****WARNING**

**Remove rings, wristwatches, neck chains, and any other jewelry before working around vehicle. Jewelry can catch on equipment and cause serious injury. Jewelry and tools may short across electrical circuits and cause damage to equipment, or severe burns or electrical shock to personnel.**

Step 73. Check for 22 to 28 VDC between high amperage 2 gauge cable at primer pump motor control solenoid terminal and a known good ground.

If 22 to 28 VDC are not present, replace high amperage 2 gauge cable between primer pump motor solenoid and B+ stud (WP 0393).

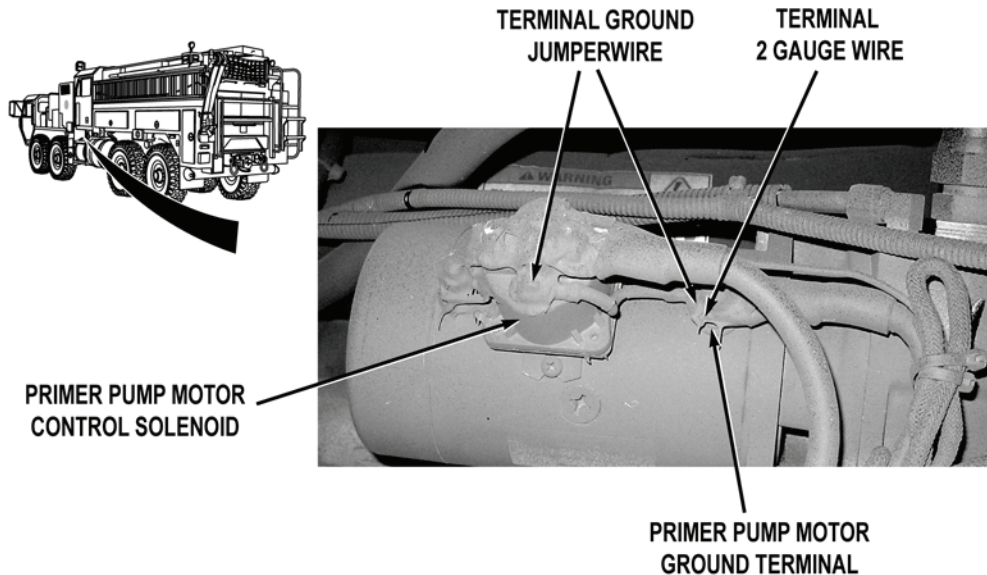
**MALFUNCTION****TEST OR INSPECTION****CORRECTIVE ACTION**

Step 74. Turn battery disconnect switch to OFF position (WP 0007). Remove 2 gauge cable from primer pump motor ground terminal (WP 0262). Check for continuity across 2 gauge cable from primer pump motor 2 gauge ground cable termination to ground stud.

If continuity is not present, replace 2 gauge cable (WP 0393).

Step 75. Install 2 gauge cable on primer pump motor ground terminal (WP 0262). Check for continuity across ground jumperwire from primer pump motor ground terminal to primer pump motor control solenoid.

If continuity is not present, repair or replace jumperwire (TM 9-2320-325-14&P).

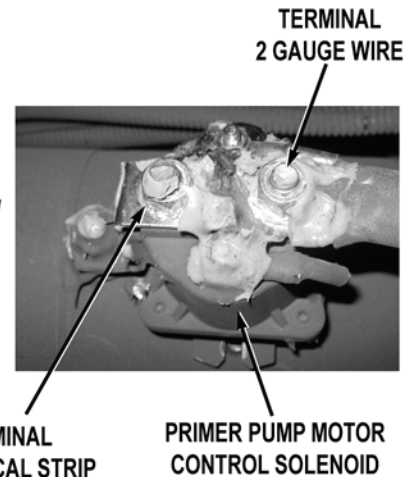
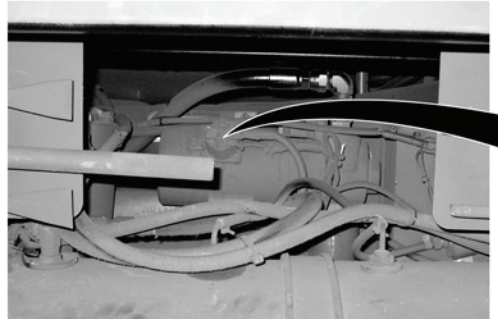

**MALFUNCTION****TEST OR INSPECTION****CORRECTIVE ACTION****WARNING**

ICON 3

**Remove rings, wristwatches, neck chains, and any other jewelry before working around vehicle. Jewelry can catch on equipment and cause serious injury. Jewelry and tools may short across electrical circuits and cause damage to equipment, or severe burns or electrical shock to personnel.**

- Step 76. Disconnect vehicle's negative battery terminals (TM 9-2320-325-14&P). Remove high amperage 2 gauge cable by disconnecting high amperage 2 gauge cable from primer pump motor control solenoid and B+ terminal (WP 0393). Reconnect vehicle's negative battery terminals (TM 9-2320-325-14&P). Turn battery disconnect switch to ON position (WP 0007). While an assistant puts and holds personnel cab PUMP PRIME switch to on position (WP 0004), check for continuity across primer pump control solenoid from high amperage 2 gauge cable terminal to primer pump electrical strip.
- a. If continuity is present, replace primer pump (WP 0262).
  - b. If continuity is not present, replace primer pump motor control solenoid (WP 0260).

**MALFUNCTION**

**TEST OR INSPECTION**

**CORRECTIVE ACTION**

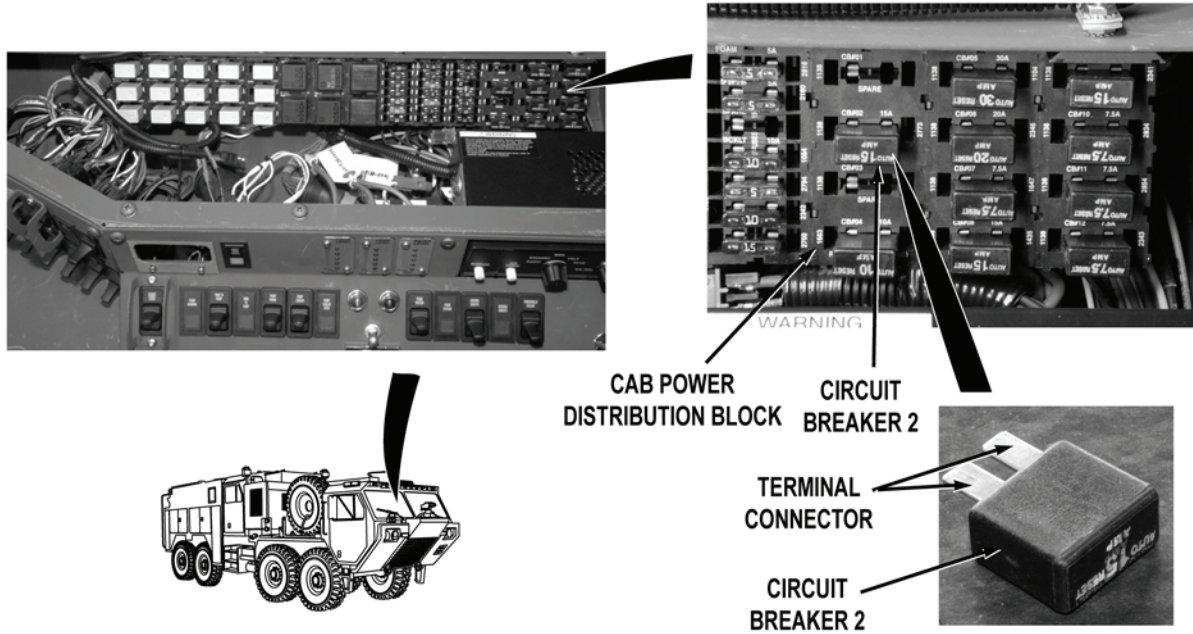

- Step 77. Remove personnel cab instrument panel A (WP 0311). Remove circuit breaker 2 from cab power distribution block (WP 0391). Check for continuity across circuit breaker.
- a. If continuity is present, replace cab power distribution wire harness and block (WP 0441).
  - b. If continuity is not present, replace circuit breaker 2 (WP 0391).

**END OF TASK**

**FOLLOW-ON MAINTENANCE**

Remove wheel chocks (TM 9-2320-347-10)

**END OF TASK**

**END OF WORK PACKAGE**

**FIELD LEVEL MAINTENANCE**

**ROOF TURRET DOES NOT OPERATE WHEN SELECTED**

**INITIAL SETUP:**

**Tools and Special Tools**

Lead Set, Test (WP 0622, Item 21)  
 Tool Kit, General Mechanic's: Automotive  
 (WP 0622, Item 27)

**Personnel Required**

MOS 63B Wheeled vehicle mechanic (2)

**References**

TM 9-2320-325-14&P  
 WP 0004  
 WP 0007  
 WP 0026  
 WP 0031

**References (continued)**

WP 0098  
 WP 0104  
 WP 0312  
 WP 0424  
 WP 0440  
 WP 0442  
 WP 0567  
 WP 0580  
 WP 0581

**Equipment Conditions**

Water pump engine OFF (WP 0022)  
 Engine OFF (TM 9-2320-347-10)  
 Wheels chocked (TM 9-2320-347-10)

**MALFUNCTION**

**TEST OR INSPECTION**

**CORRECTIVE ACTION**

**ROOF TURRET DOES NOT OPERATE WHEN SELECTED**

---

**MALFUNCTION****TEST OR INSPECTION****CORRECTIVE ACTION**

---

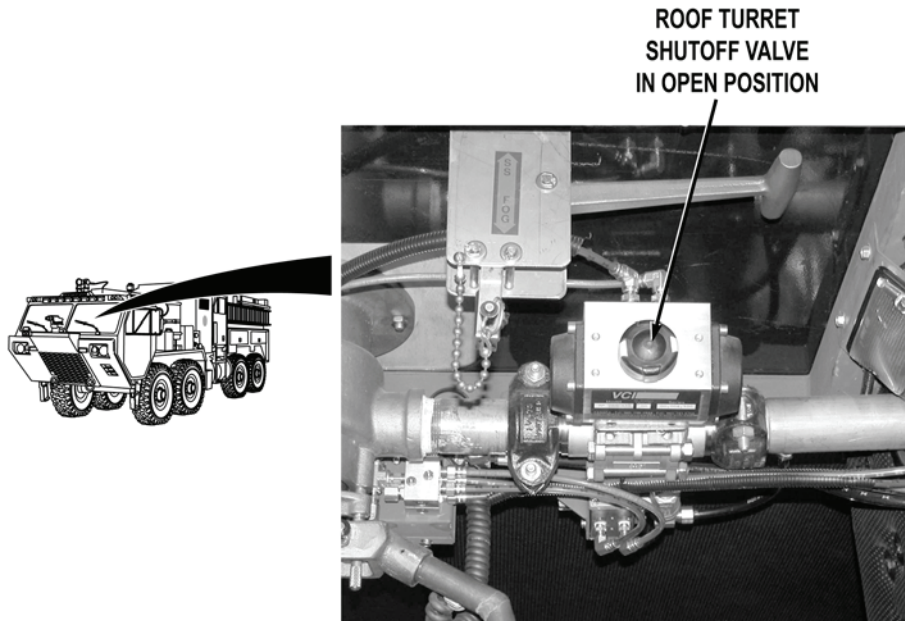
**NOTE**

- Ensure system air pressure is at least 85 psi (586 kPa) during this procedure. System air pressure is required to activate valves.
- Do not engage water pump engine during this procedure, except when performing complete system checks. Valve operations can be checked without water pump operation.
- Valve operations can be checked by observing valve shaft rotation. Valves are open when tabs or yellow paint tabs are aligned with fluid flow.

Step 1. Turn battery disconnect switch to ON position (WP 0007). If system air pressure is below 85 psi (586 kPa), start vehicle engine and allow system air pressure to build to at least 85 psi (586 kPa) (TM 9-2320-347-10). Shut off vehicle engine (TM 9-2320-347-10). Push and release agent discharge button on roof turret control handle (WP 0004), check if roof turret valve operates to open position.

If roof turret valve does not operate, go to Step 3.

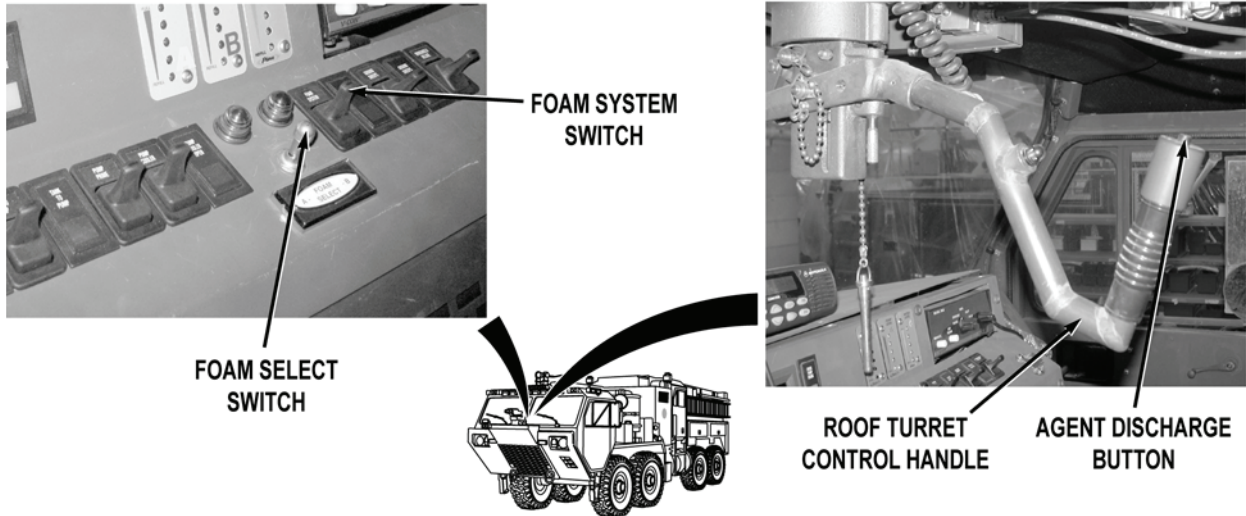
**MALFUNCTION****TEST OR INSPECTION****CORRECTIVE ACTION**

**⚠ CAUTION**

- **Do not mix different types or brands of foam agent in foam cells or piping. Mixing of different foam agents (either type or manufacturer) may cause deterioration of foam agent, improper proportioning and poor performance in a fire situation. Mixing of Class A and Class B foam agents may result in a chemical reaction which can create globules, which can clog orifices and cause system failure.**
- **Failure to flush foam system after each foam use could result in equipment damage.**

- Step 2. Pump from onboard water tank (WP 0026). Put cab FOAM SYSTEM switch to on position (WP 0004). Put cab FOAM SELECT switch to A position (WP 0004). Push and release roof turret agent discharge button (WP 0004). Check if foam is delivered from roof turret. Flush foam system (WP 0031).
- a. If foam is delivered from roof turret, fault corrected.
  - b. If foam is not delivered from roof turret, troubleshoot Foam Not Delivered From Roof Turret (WP 0098).

---

**MALFUNCTION****TEST OR INSPECTION****CORRECTIVE ACTION**

---

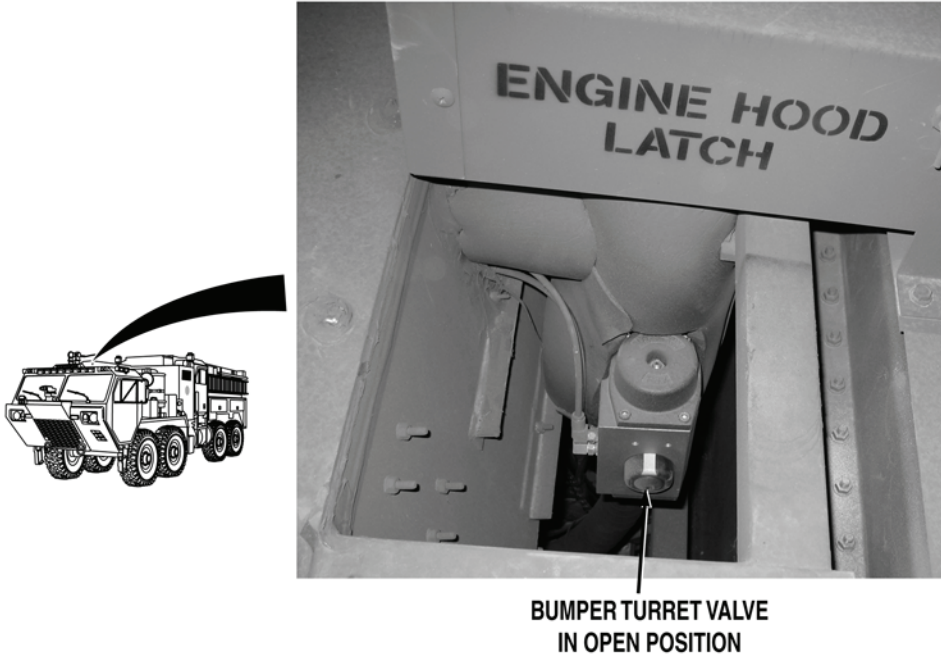

- Step 3. Put bumper turret control POWER switch to | (on) position (WP 0004). While an assistant pushes bumper turret control discharge switch (WP 0004), check if bumper turret valve operates to open position.

If bumper turret valve does not operate, troubleshoot Bumper Turret Does Not Operate Properly When Selected (WP 0104).

---

**MALFUNCTION****TEST OR INSPECTION****CORRECTIVE ACTION**

---

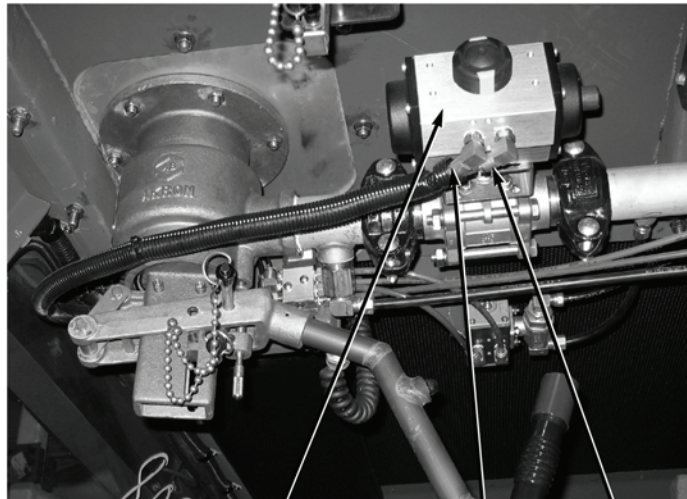
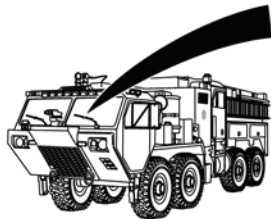
ROOF TURRET  
SHUTOFF VALVEBLUE AIR  
LINERED AIR  
LINE

- Step 4. Inspect air lines, from roof turret control valve to roof turret shutoff valve for leaks, kinks, or damage.

If air lines are not free from leaks, kinks, or damage, replace damaged air lines (WP 0567).

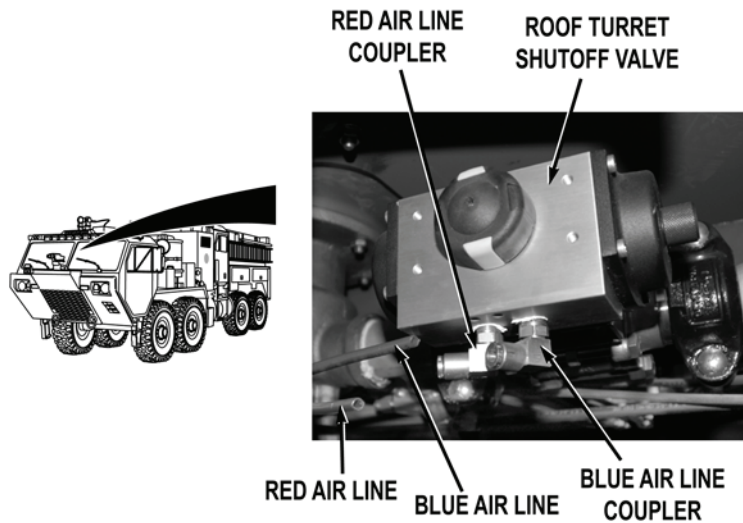
**MALFUNCTION****TEST OR INSPECTION****CORRECTIVE ACTION****WARNING**

- If air lines are under pressure when they are disconnected, they can whip around and cause injury to personnel. Caution should be exercised when disconnecting air line fittings.
- Air lines may be under pressure when control valve is operated. If under pressure and air lines are disconnected, air lines may whip around and cause injury to personnel. Caution should be exercised when operating control valve with air lines disconnected.

**NOTE**

Air pressure is checked by disconnecting air lines at roof turret valve and observing air pressure escaping from air lines when roof turret valve is activated. Air will escape from blue air line when roof turret control discharge switch is pressed, and escape from red air line when roof turret control discharge switch is released. System air pressure may drop below 85 psi (586 kPa) during this procedure.

- Step 5. Disconnect air lines at roof turret valve. Push and release agent discharge button on roof turret control handle (WP 0004), check if air pressure is present at roof turret valve.

If there is air pressure, replace roof turret valve (WP 0580).

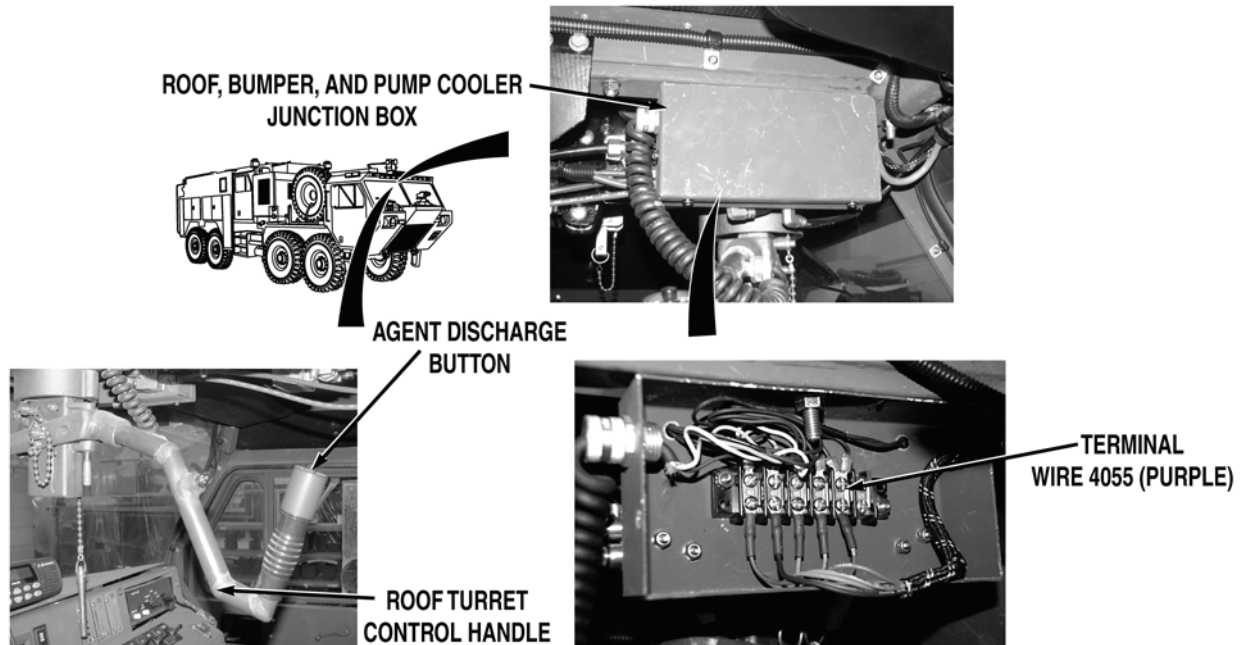

**MALFUNCTION****TEST OR INSPECTION****CORRECTIVE ACTION****WARNING**

**Remove rings, wristwatches, neck chains, and any other jewelry before working around vehicle. Jewelry can catch on equipment and cause serious injury. Jewelry and tools may short across electrical circuits and cause damage to equipment, or severe burns or electrical shock to personnel.**

- Step 6. Connect air lines at roof turret shutoff valve. Push and release agent discharge button on roof turret control handle (WP 0004). Check for 22 to 28 VDC between cab roof wire harness wire 4055 (purple) at roof, bumper, pump cooler junction box control terminal strip and a known good ground.

If 22 to 28 VDC are not present, go to Step 9.

---

**MALFUNCTION****TEST OR INSPECTION****CORRECTIVE ACTION**

---

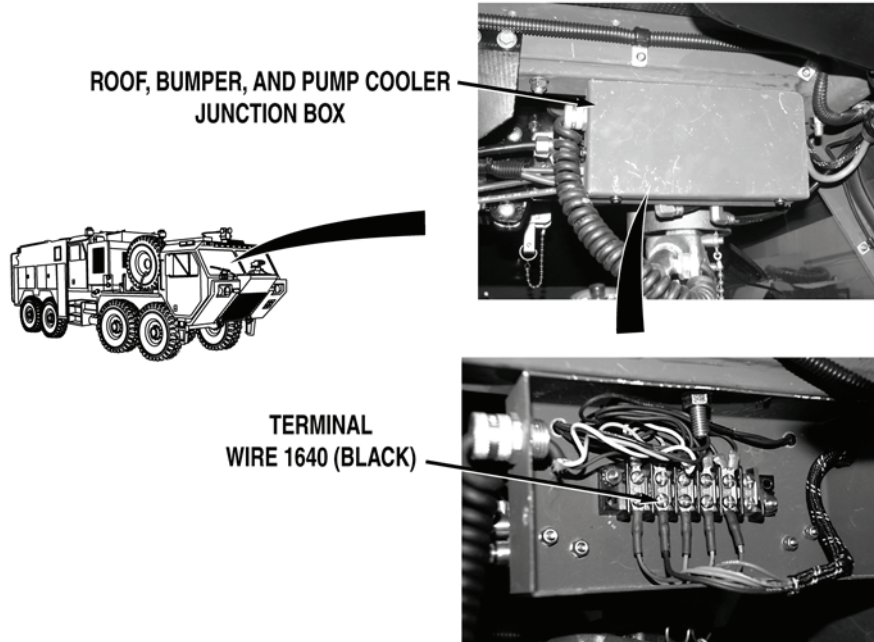

- Step 7. Push and release roof turret discharge switch (WP 0004). Turn battery disconnect switch to OFF position (WP 0007). Check for continuity across cab roof wire harness wire 1640 (black) from roof, bumper, and pump cooler junction box control terminal strip to a known good ground.

If there is continuity, replace roof turret control valve (WP 0424).

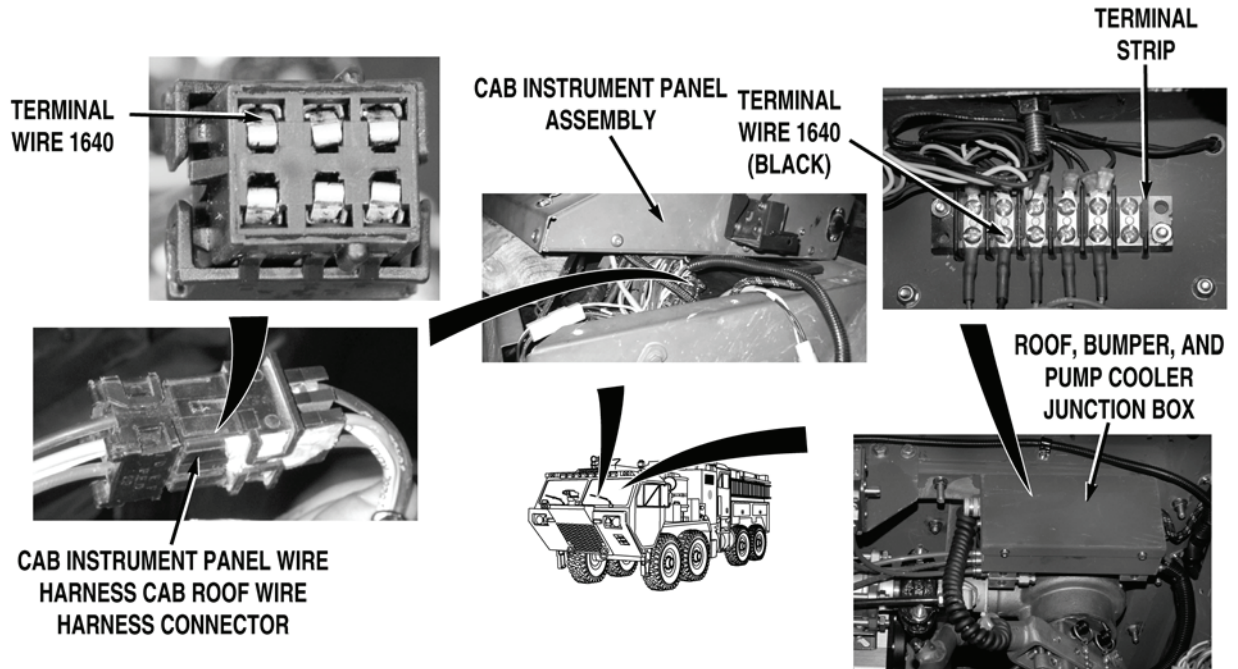
**MALFUNCTION****TEST OR INSPECTION****CORRECTIVE ACTION**

- Step 8. Remove personnel cab instrument panel assembly (WP 0312). Disconnect cab instrument panel wire harness cab roof wire harness connector. Check for continuity across wire 1640 (black) from roof, bumper, and pump cooler junction box terminal strip, terminal to cab instrument panel wire harness cab roof wire harness connector, terminal E.
- a. If there is continuity, repair wire 1640 in cab instrument panel wire harness if repairable (TM 9-2320-325-14&P), or replace cab instrument panel wire harness (WP 0440).
  - b. If there is no continuity, repair wire 1640 in cab roof wire harness if repairable (TM 9-2320-325-14&P), or replace cab roof wire harness (WP 0442).

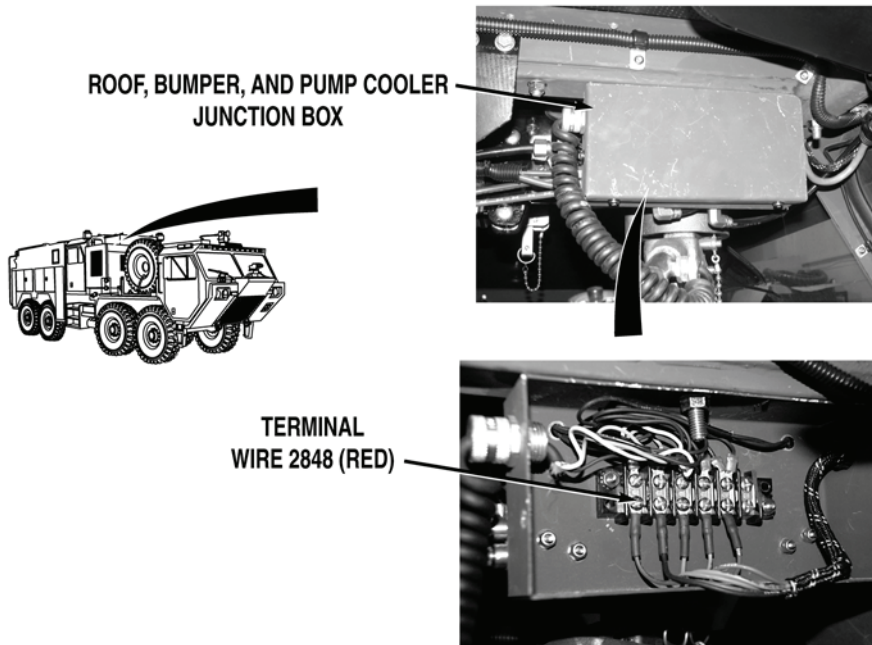
**MALFUNCTION****TEST OR INSPECTION****CORRECTIVE ACTION****WARNING**

**Remove rings, wristwatches, neck chains, and any other jewelry before working around vehicle. Jewelry can catch on equipment and cause serious injury. Jewelry and tools may short across electrical circuits and cause damage to equipment, or severe burns or electrical shock to personnel.**

- Step 9. Push and release agent discharge button on roof turret control handle (WP 0004). Check for 22 to 28 VDC between cab roof wire harness wire 2848 (red) at roof, bumper, pump cooler junction box control terminal strip, terminal and a known good ground.

If 22 to 28 VDC are not present, go to Step 11.

---

**MALFUNCTION****TEST OR INSPECTION****CORRECTIVE ACTION**

---

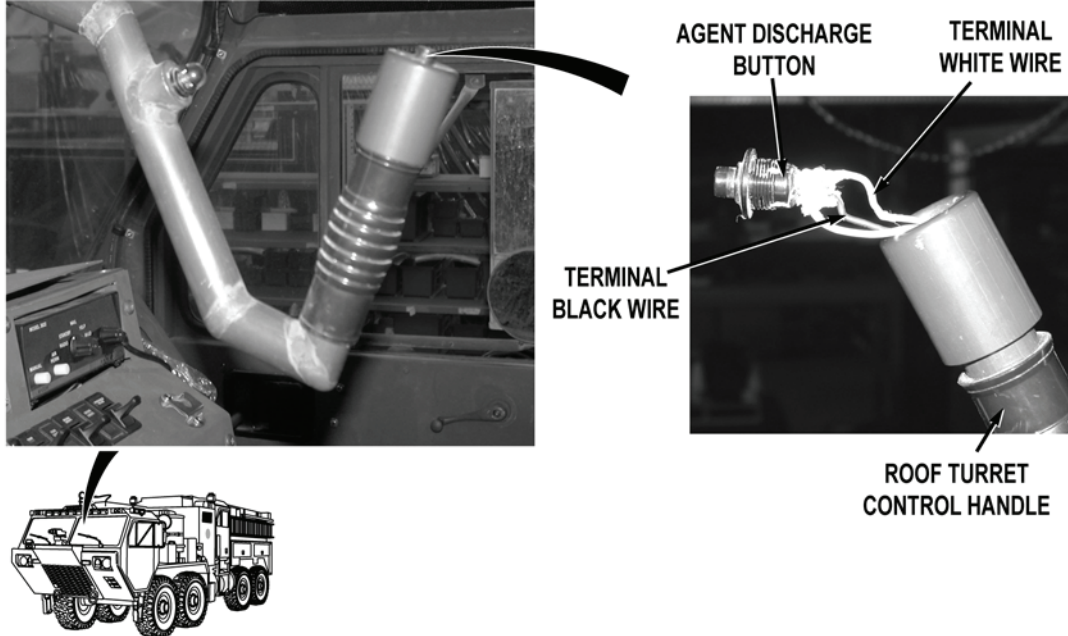

- Step 10. Turn battery disconnect switch to OFF position (WP 0007). While an assistant pushes and holds agent discharge button on roof turret control handle (WP 0004), check for continuity across agent discharge button from terminal black wire to terminal white wire.
- a. If there is continuity, replace roof turret power cable (WP 0581).
  - b. If there is no continuity, replace agent discharge button (WP 0581).

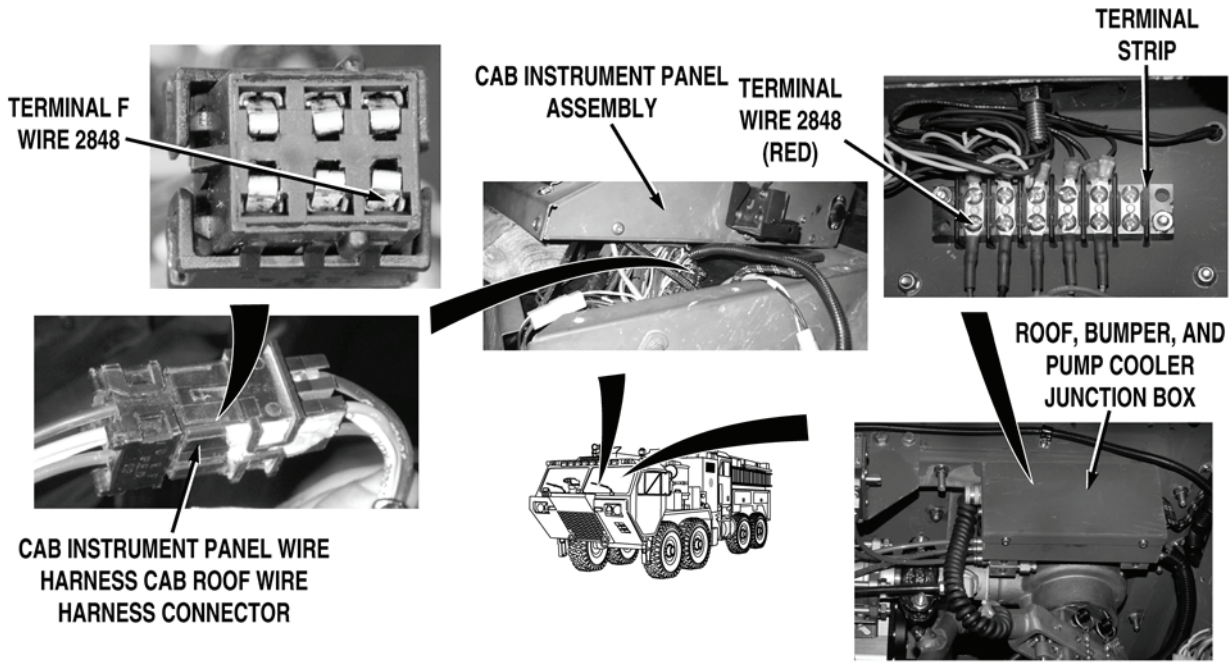
**MALFUNCTION****TEST OR INSPECTION****CORRECTIVE ACTION**

- Step 11. Remove personnel cab instrument panel assembly (WP 0312). Disconnect cab instrument panel wire harness cab roof wire harness connector. Check for continuity across wire 2848 (red) from roof, bumper, and pump cooler junction box terminal strip, terminal to cab instrument panel wire harness cab roof wire harness connector, terminal F.
- a. If there is continuity, repair wire 2848 in cab instrument panel wire harness if repairable (TM 9-2320-325-14&P), or replace cab instrument panel wire harness (WP 0440).
  - b. If there is no continuity, repair wire 2848 in cab roof wire harness if repairable (TM 9-2320-325-14&P), or replace cab roof wire harness (WP 0442).

**END OF TASK****FOLLOW-ON MAINTENANCE**

Remove wheel chocks (TM 9-2320-347-10)

**END OF TASK****END OF WORK PACKAGE**

---

**FIELD LEVEL MAINTENANCE**
**SYSTEM WILL NOT BUILD OR HOLD AIR PRESSURE DURING BLOW-OUT PROCEDURE**

---

**INITIAL SETUP:****Tools and Special Tools**

Tool Kit, General Mechanic's: Automotive  
(WP 0622, Item 27)

**Personnel Required**

MOS 63B Wheeled vehicle mechanic (2)

**References**

WP 0004  
WP 0015  
WP 0044  
WP 0113  
WP 0119  
WP 0294  
WP 0484  
WP 0295  
WP 0296  
WP 0387  
WP 0388  
WP 0482

**References (continued)**

WP 0485  
WP 0486  
WP 0487  
WP 0488  
WP 0493  
WP 0494  
WP 0495  
WP 0496  
WP 0576  
WP 0580

**Equipment Conditions**

Water pump engine OFF (WP 0022)  
Engine OFF (TM 9-2320-347-10)  
Wheels chocked (TM 9-2320-347-10)

**MALFUNCTION****TEST OR INSPECTION****CORRECTIVE ACTION**

---

**SYSTEM WILL NOT BUILD OR HOLD AIR PRESSURE DURING BLOW-OUT PROCEDURE****WARNING**

- Be careful when using high air pressure. High air pressure can blow out parts or debris with force.
- Driver side pre-connect A and B hoses must be disconnected prior to performing tests procedure. Hoses may become pressurized, causing injury to personnel and/or damage to equipment.

---

**MALFUNCTION****TEST OR INSPECTION****CORRECTIVE ACTION**

---

**NOTE**

- Do not open any valves during this step.
- Remove all caps prior to applying air pressure.
- Ensure system air pressure is at least 85 PSI (586 kPa) during this procedure.
- Valves are open when tabs or yellow paint tabs are aligned with direction of fluid flow.

Step 1. Install blow-out adapter to PASSENGER AUXILIARY INLET (WP 0044). While an assistant connects air hose to blow-out adapter (WP 0044), check if pressure is displayed on PUMP DISCHARGE digital gauge (WP 0004).

If pressure is displayed on PUMP DISCHARGE digital gauge, repair (WP 0387) or replace passenger side auxiliary inlet valve (WP 0294).

**WARNING**

**Be careful when using high air pressure. High air pressure can blow out parts, hoses, or debris with force. Failure to comply could result in injury to personnel.**

**NOTE**

- Do not open any valves during this procedure except PASSENGER SIDE AUXILIARY. Have an assistant maintain 50 PSI (345 kPa) during test.
- Check all valves to ensure that more than one valve is not leaking.
- Ensure system air pressure is at least 85 PSI (586 kPa) during this procedure.

Step 2. While an assistant operates PASSENGER AUX INLET valve control (WP 0004), check if pressure is displayed on PUMP DISCHARGE digital gauge (WP 0004).

If pressure is not displayed on PUMP DISCHARGE digital display, troubleshoot Passenger Side Auxiliary Inlet Valve Does Not Operate Properly (WP 0113).

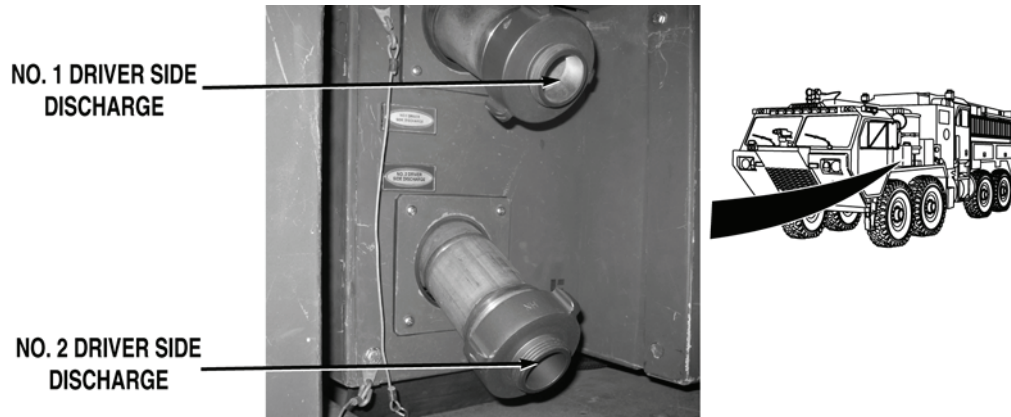

**MALFUNCTION****TEST OR INSPECTION****CORRECTIVE ACTION**

Step 3. While an assistant maintains 50 PSI (345 kPa) on PUMP DISCHARGE digital gauge (WP 0004). Check if air can be heard escaping from No. 1 DRIVER SIDE DISCHARGE.

If air can be heard escaping from No. 1 DRIVER SIDE DISCHARGE, repair (WP 0387) or replace No. 1 Driver Side Discharge Valve (WP 0485).

Step 4. Check if air can be heard escaping from No. 2 DRIVER SIDE DISCHARGE

If air can be heard escaping from No. 2 DRIVER SIDE DISCHARGE, repair (WP 0387) or replace No. 2 Driver Side Discharge Valve (WP 0486).

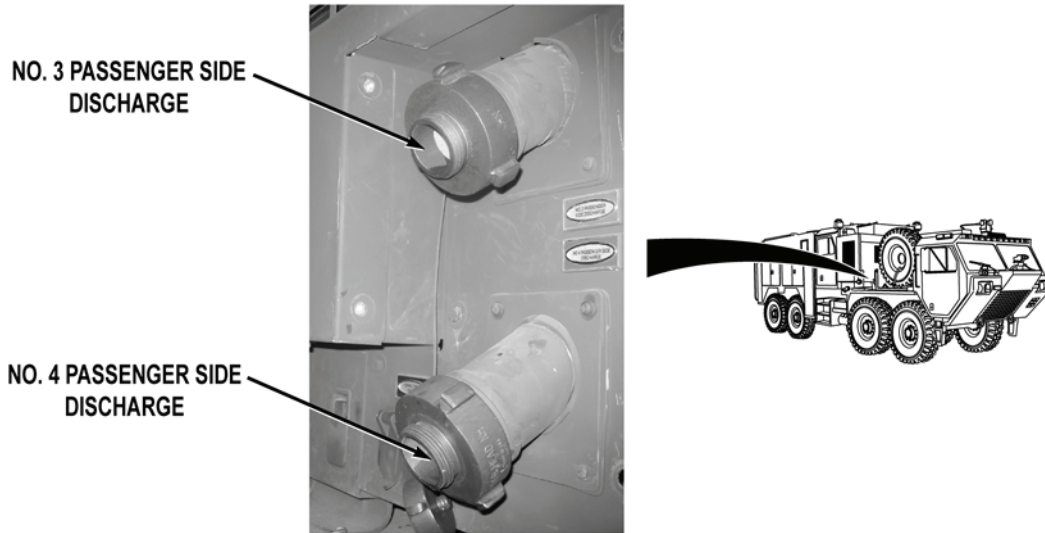
**MALFUNCTION****TEST OR INSPECTION****CORRECTIVE ACTION**

Step 5. Check if air can be heard escaping from No. 3 PASSENGER SIDE DISCHARGE.

If air can be heard escaping from No. 3 PASSENGER SIDE DISCHARGE, repair (WP 0387) or replace No. 3 Passenger Side Discharge Valve (WP 0487).

Step 6. Check if air can be heard escaping from No. 4 PASSENGER SIDE DISCHARGE

If air can be heard escaping from No. 4 PASSENGER SIDE DISCHARGE, repair (WP 0387) or replace No. 4 Passenger Side Discharge Valve (WP 0488).

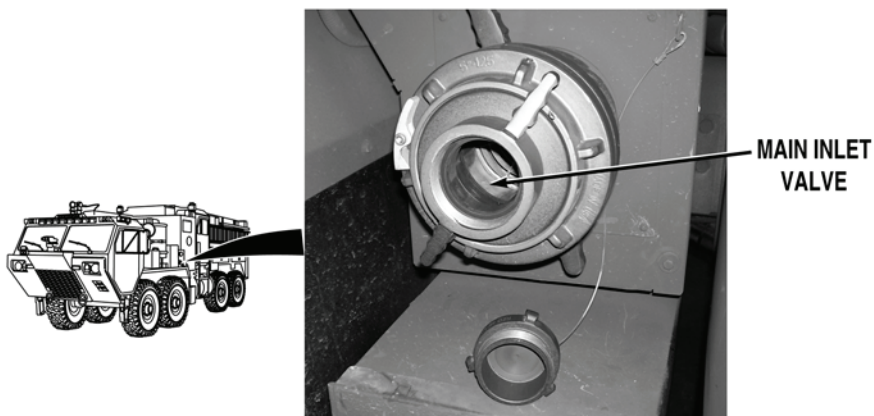
**MALFUNCTION****TEST OR INSPECTION****CORRECTIVE ACTION**

Step 7. Check if air can be heard escaping from main inlet valve.

If air can be heard escaping from main inlet valve, repair (WP 0387) or replace Main Inlet Valve (Driver Side) (WP 0484).



Step 8. Open hose bed covers (WP 0015). Check if air can be heard escaping from DRIVER PRE-CONNECT A hose connection.

If air can be heard escaping from DRIVER PRE-CONNECT A hose connection, repair (WP 0387) or replace Driver Pre-Connect A valve (WP 0495).

Step 9. Check if air can be heard escaping from DRIVER PRE-CONNECT B hose connection.

If air can be heard escaping from DRIVER PRE-CONNECT B hose connection, repair (WP 0387) or replace Driver Pre-Connect B valve (WP 0496).

---

**MALFUNCTION****TEST OR INSPECTION****CORRECTIVE ACTION**

---

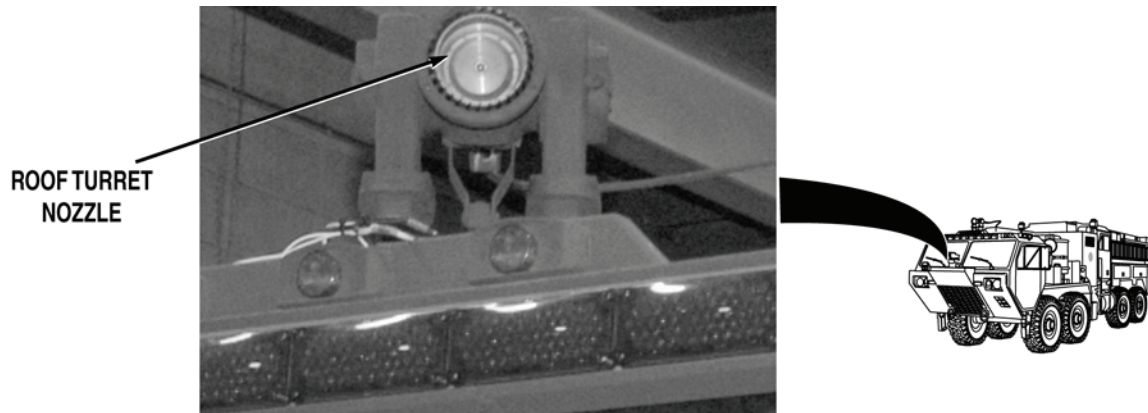

Step 10. Check if air can be heard escaping from roof turret nozzle.

If air can be heard escaping from roof turret nozzle, replace roof turret valve (WP 0580).



Step 11. Check if air can be heard escaping from bumper turret nozzle.

If air can be heard escaping from bumper turret nozzle, replace bumper turret valve (WP 0482).

---

**MALFUNCTION**  
**TEST OR INSPECTION**  
**CORRECTIVE ACTION**

---

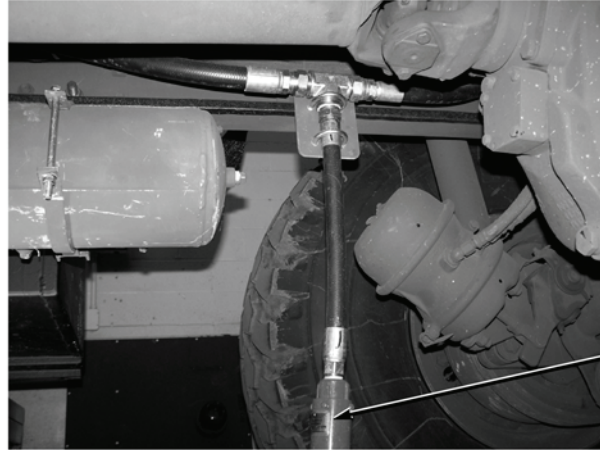

GROUND SWEEPS  
NOZZLE

Step 12. Check if air can be heard escaping from ground sweeps nozzle.

If air can be heard escaping from ground sweeps, replace ground sweeps valve (WP 0576).

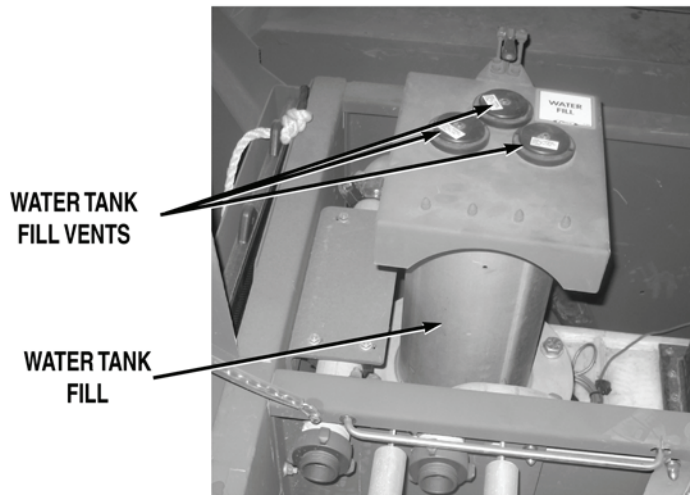

Step 13. Check if air can be heard escaping from water tank fill vents.

- a. If air can be heard escaping from water tank fill vents, go to Step 14.
- b. If air cannot be heard escaping from water tank fill vents, fault corrected.

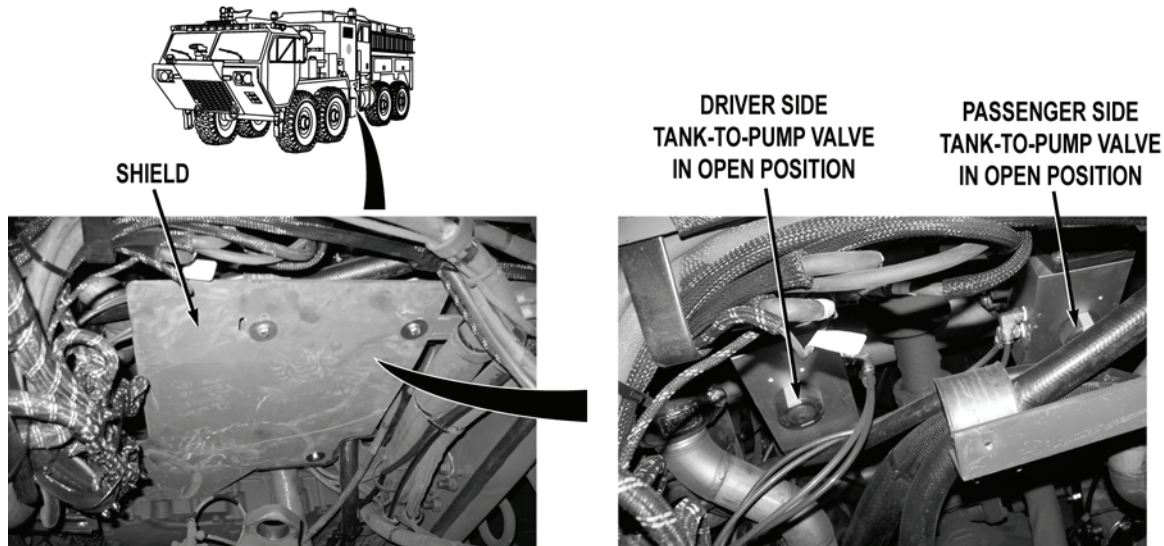
**MALFUNCTION****TEST OR INSPECTION****CORRECTIVE ACTION****NOTE**

- Ensure system air pressure is at least 85 PSI (586 kPa) during this procedure.
- Valves are open when tabs or yellow paint tabs are aligned with direction of fluid flow.

Step 14. Remove shield (WP 0493). Check if both tank-to-pump valves are closed.

If one or both tank-to-pump valves are open, troubleshoot Tank-To-Pump Valve(s) Does Not Operate Properly (WP 0119).

**WARNING**

- **Be careful when using high air pressure. High air pressure can blow out parts or debris with force.**
- **Air pressure should not exceed 50 PSI (345 kPa) during procedure. Failure to comply may result in damage to equipment. Failure to comply may result in injury to personnel.**

Step 15. Remove passenger side tank-to-pump check valve boot (WP 0296). While an assistant puts 50 PSI (345 kPa) air pressure to system (WP 0044). Check if air pressure can be heard escaping past passenger side tank-to-pump valve.

If air pressure can be heard escaping past passenger side tank-to-pump valve, replace passenger side tank-to-pump valve (WP 0494).

---

**MALFUNCTION****TEST OR INSPECTION****CORRECTIVE ACTION**

---

- Step 16. Install passenger side tank-to-pump check valve boot (WP 0296). Remove driver side tank-to-pump check valve boot (WP 0295). While an assistant puts 50 PSI (345 kPa) air pressure to system (WP 0044). Check if air pressure can be heard escaping past driver side tank-to-pump valve.
- a. If air pressure can be heard escaping past driver side tank-to-pump valve, replace driver side tank-to-pump valve (WP 0493).
  - b. If air pressure cannot be heard escaping past driver side tank-to-pump valve, repair (WP 0387) or replace tank fill & re-circulating valve (WP 0388).

**END OF TASK****FOLLOW-ON MAINTENANCE**

1. Install shield if removed (WP 0493)
2. Remove wheel chocks (TM 9-2320-347-10)

**END OF TASK****END OF WORK PACKAGE**





**FIELD LEVEL MAINTENANCE**

**TANK FILL & RE-CIRCULATING VALVE DOES NOT OPERATE PROPERLY**

**INITIAL SETUP:**

**Tools and Special Tools**

- Lead Set, Test (WP 0622, Item 21)
- Tool Kit, General Mechanic's: Automotive (WP 0622, Item 27)

**References**

- TM 9-2320-325-14&P
- WP 0004
- WP 0007
- WP 0029
- WP 0299
- WP 0325

**References (continued)**

- WP 0387
- WP 0388
- WP 0412
- WP 0418
- WP 0453
- WP 0457
- WP 0459
- WP 0539
- WP 0540

**Equipment Conditions**

- Water pump engine OFF (WP 0022)
- Engine OFF (TM 9-2320-347-10)

**MALFUNCTION**

**TEST OR INSPECTION**

**CORRECTIVE ACTION**

**TANK FILL & RE-CIRCULATING VALVE DOES NOT OPERATE PROPERLY**

**MALFUNCTION**

**TEST OR INSPECTION**

**CORRECTIVE ACTION**

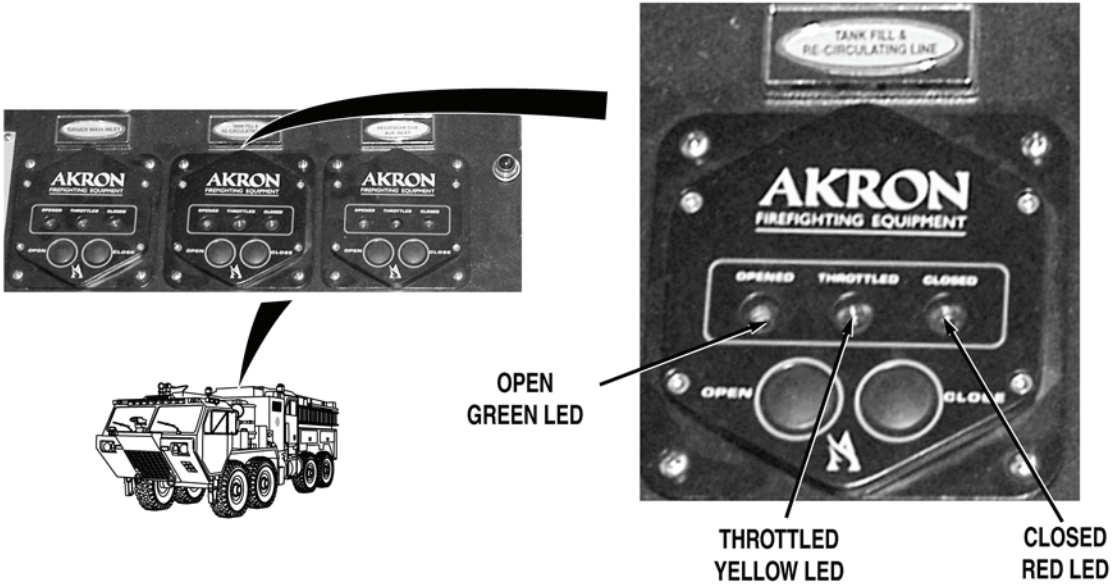

**NOTE**

Ensure batteries are fully charged before performing Step 1.

- Step 1. Turn battery disconnect switch to ON position (WP 0007). Check if pump operator's panel TANK FILL & RE-CIRCULATING LINE valve control display illuminates.

If display is not illuminated, go to Step 9.

---

<b>MALFUNCTION</b>	<b>TEST OR INSPECTION</b>	<b>CORRECTIVE ACTION</b>
--------------------	---------------------------	--------------------------

---

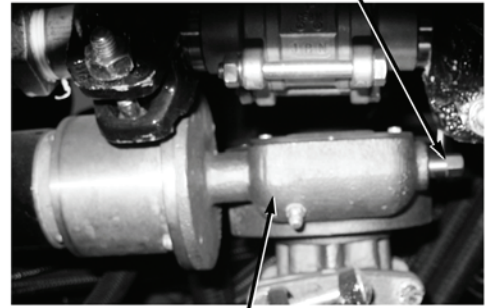
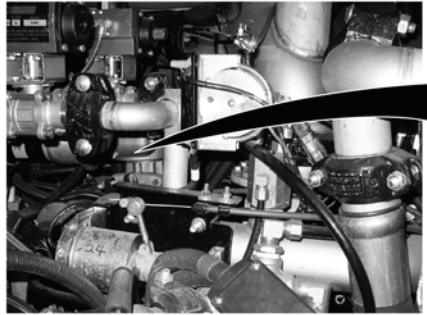

TANK FILL AND RE-CIRCULATING LINE VALVE

### NOTE

Valve operation can be checked either by noting vibration of valve assembly, or by observing rotation of 7/16 in. hex at end of valve drive assembly worm gearshaft.

- Step 2. Open pump house panel A (WP 0539). While an assistant pushes pump operator's panel TANK FILL & RE-CIRCULATING LINE valve control OPEN and CLOSE buttons (WP 0004), check if tank fill & re-circulating line valve operates.

If tank fill & re-circulating line valve does not open and close, go to Step 5.

**MALFUNCTION**

**TEST OR INSPECTION**

**CORRECTIVE ACTION**

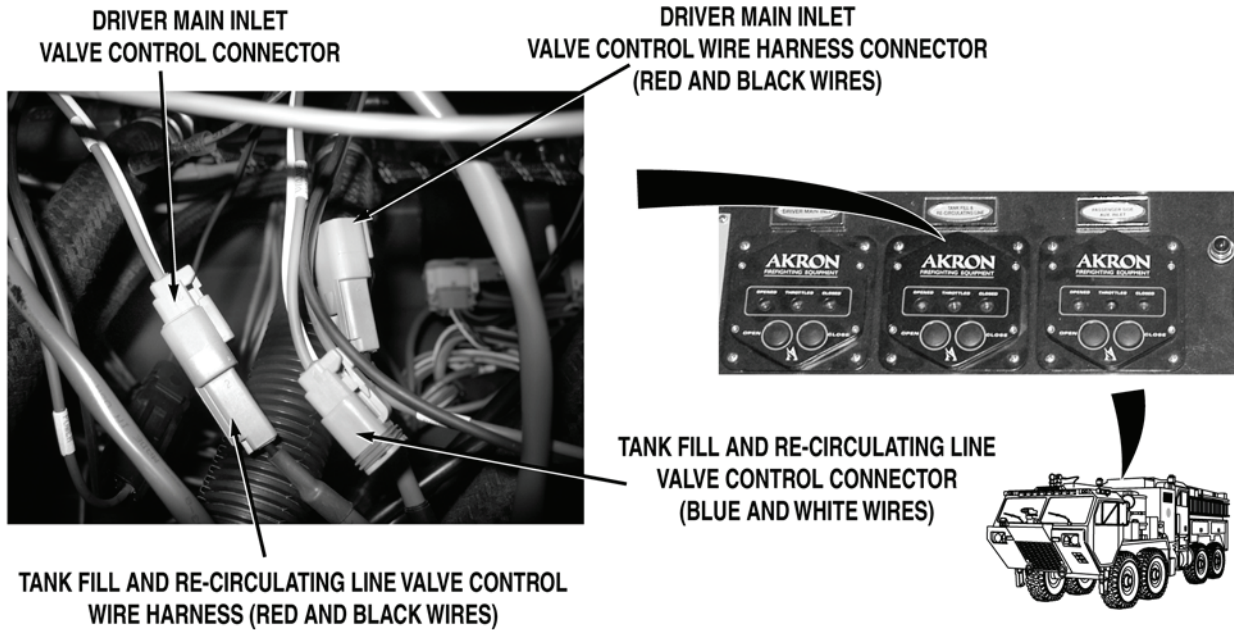

**WARNING**



Remove rings, wristwatches, neck chains, and any other jewelry before working around vehicle. Jewelry can catch on equipment and cause serious injury. Jewelry and tools may short across electrical circuits and cause damage to equipment, or severe burns or electrical shock to personnel.

**NOTE**

- Valve operations must be checked by observing rotation of 7/16 in. hex at end of valve drive assembly worm gearshaft for Step 3.
- TANK FILL & RE-CIRCULATING LINE valve control will indicate THROTTLED with a yellow indicator when valve is partially opened or closed.

---

**MALFUNCTION****TEST OR INSPECTION****CORRECTIVE ACTION**

---

- Step 3. Turn battery disconnect switch to OFF position (WP 0007). Open pump operator's panel housing (WP 0325). Disconnect valve control wire harness connector from TANK FILL & RE-CIRCULATING LINE valve control. Disconnect valve control wire harness connector from DRIVER MAIN INLET valve control. Connect TANK FILL & RE-CIRCULATING LINE valve control wire harness connector to DRIVER MAIN INLET valve control connector. Turn battery disconnect switch to ON position (WP 0007). While an assistant monitors operation of tank fill & re-circulating line valve, push pump operator's panel DRIVER MAIN INLET valve control OPEN and CLOSE buttons (WP 0004). Check if DRIVER MAIN INLET valve control OPENED (green) and CLOSED (red) indicators illuminate before tank fill & re-circulating line valve is fully open and closed.

If DRIVER MAIN INLET valve control OPENED (green) and CLOSED (red) indicators do not illuminate before tank fill & re-circulating line valve is fully opened or closed, reconnect valve control wire harnesses to original positions and replace TANK FILL & RE-CIRCULATING LINE valve control (WP 0418).

**NOTE**

Water tank must be drained. Water will be released from water tank uncontrollably when tank fill & re-circulating valve is removed.

- Step 4. Drain water tank if required (WP 0029). Turn battery disconnect switch to OFF position (WP 0007). Reconnect valve control wire harnesses to original positions. Remove tank fill & re-circulating line valve (WP 0299) and inspect it for binding, damage, and contamination.
- a. If tank fill & re-circulating line valve is free from binding, damage and contamination, reinstall valve and replace tank fill & re-circulating line valve motor and drive assembly (WP 0388), and go to Step 5.
  - b. If tank fill & re-circulating line valve is binding, damaged, and/or contaminated, repair (WP 0387), or replace tank fill & re-circulating line valve (WP 0299).

**MALFUNCTION**

**TEST OR INSPECTION**

**CORRECTIVE ACTION**



TANK FILL AND RE-CIRCULATING LINE VALVE CONTROL WIRE HARNESS CONNECTOR

TANK AND FILL RECIRCULATING VALVE CONTROL WIRE HARNESS CONNECTOR

**WARNING**



**Remove rings, wristwatches, neck chains, and any other jewelry before working around vehicle. Jewelry can catch on equipment and cause serious injury. Jewelry and tools may short across electrical circuits and cause damage to equipment, or severe burns or electrical shock to personnel.**

Step 5. Open pump house panel A (WP 0539). Turn battery disconnect switch to OFF position (WP 0007). Open pump operator's panel housing (WP 0325). Check tank fill & re-circulating valve control wire harness from TANK FILL & RE-CIRCULATING LINE valve control to tank fill & re-circulating line valve motor for loose connections.

If connections are loose, tighten loose connections (WP 0453).

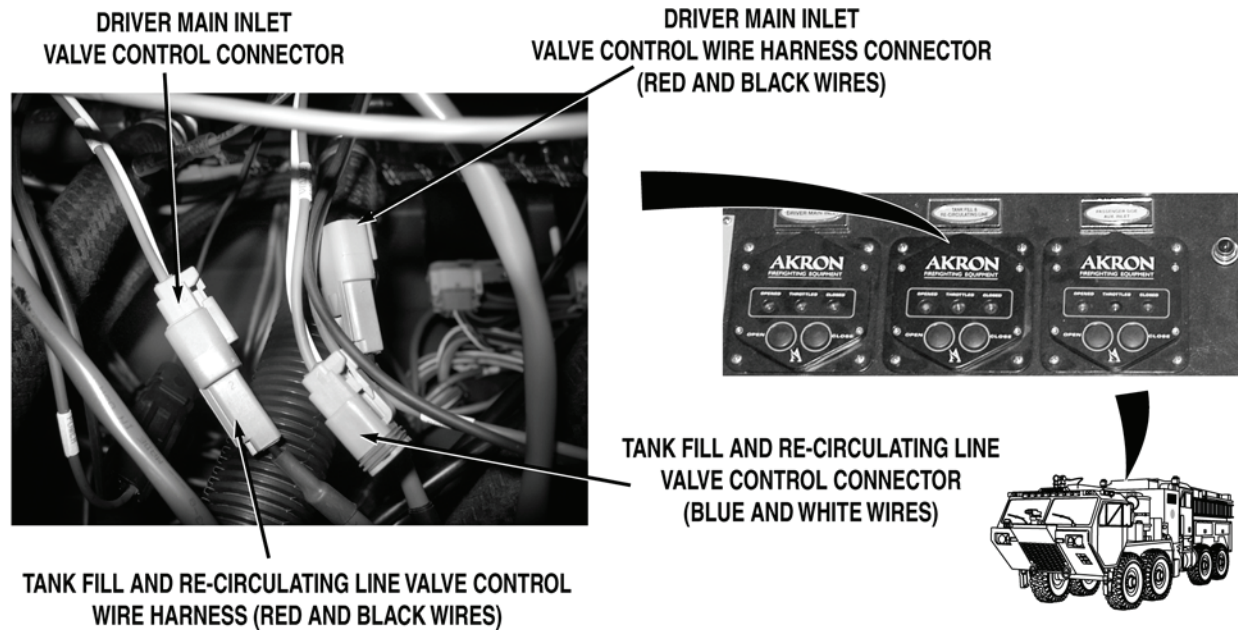
**MALFUNCTION****TEST OR INSPECTION****CORRECTIVE ACTION****NOTE**

- Do not engage water pump engine during this procedure. Valve operations can be checked without water pump operation.
- Valve motor operation can be checked either by noting vibration of valve assembly, or by observing rotation of 7/16 in. hex at end of valve drive assembly worm gearshaft.

Step 6. Turn battery disconnect switch to ON position (WP 0007). While an assistant pushes pump operator's panel TANK FILL & RE-CIRCULATING LINE valve control OPEN and CLOSE buttons (WP 0004), check if TANK FILL & RE-CIRCULATING LINE valve control yellow THROTTLED indicator illuminates and tank fill & re-circulating line valve motor operates.

If indicator illuminates and valve motor operates, replace tank fill & re-circulating line valve drive assembly (WP 0388).

**MALFUNCTION**

**TEST OR INSPECTION**

**CORRECTIVE ACTION**

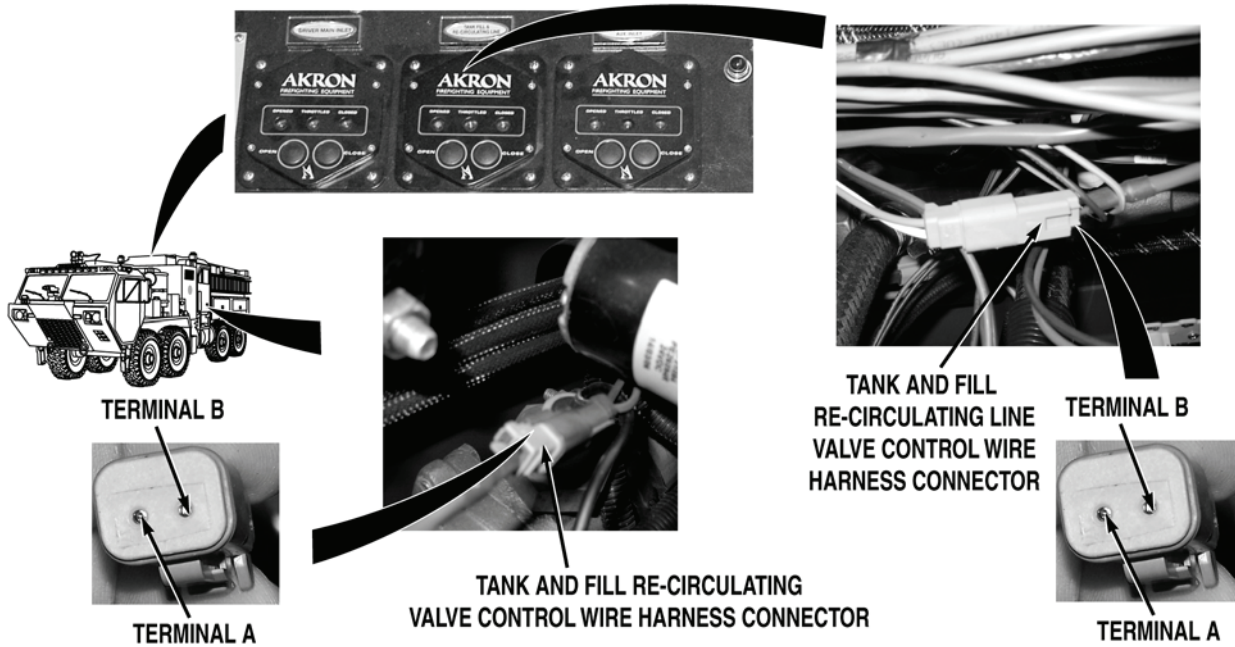

**WARNING**



Remove rings, wristwatches, neck chains, and any other jewelry before working around vehicle. Jewelry can catch on equipment and cause serious injury. Jewelry and tools may short across electrical circuits and cause damage to equipment, or severe burns or electrical shock to personnel.

- Step 7. Turn battery disconnect switch to OFF position (WP 0007). Disconnect valve control wire harness connectors from TANK FILL & RE-CIRCULATING LINE valve control and tank fill & re-circulating line valve motor. With a test lead set, check for continuity between valve motor valve control wire harness and TANK FILL & RE-CIRCULATING LINE valve control connectors terminal to terminal.

If there is no continuity, repair wires (TM 9-2320-325-14&P), or replace tank fill & re-circulating line valve control wire harness (WP 0453).

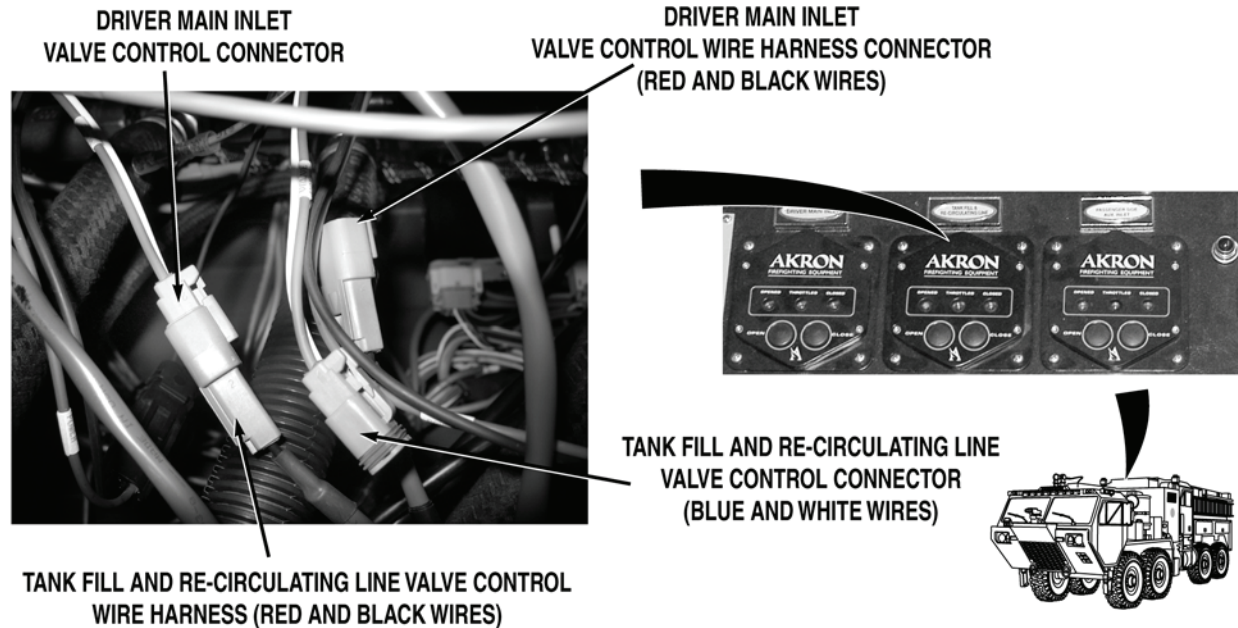

**MALFUNCTION****TEST OR INSPECTION****CORRECTIVE ACTION**

- Step 8. Connect valve control wire harness connector to tank fill & re-circulating line valve motor. Disconnect valve control wire harness connectors from DRIVER MAIN INLET valve control. Connect tank fill & re-circulating line valve control wire harness connector to DRIVER MAIN INLET valve control. Turn battery disconnect switch to ON position (WP 0007). While an assistant pushes pump operator's panel DRIVER MAIN INLET valve control OPEN and CLOSE buttons (WP 0004), check if tank fill & re-circulating line valve operates.
- If tank fill & re-circulating line valve operates, reconnect valve control wire harness connectors to original positions and replace TANK FILL & RE-CIRCULATING LINE valve control (WP 0418).
  - If tank fill & re-circulating line valve does not operate, reconnect valve control wire harness connectors to original positions and replace tank fill & re-circulating line valve motor (WP 0388).

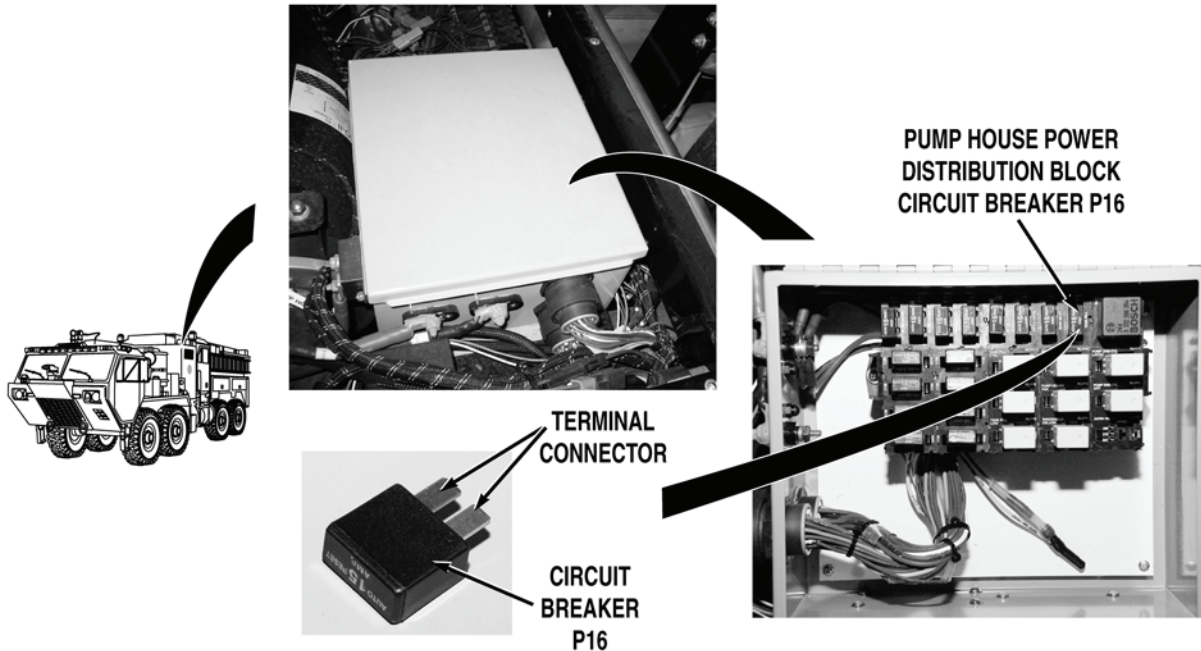
**MALFUNCTION****TEST OR INSPECTION****CORRECTIVE ACTION****WARNING**

**Remove rings, wristwatches, neck chains, and any other jewelry before working around vehicle. Jewelry can catch on equipment and cause serious injury. Jewelry and tools may short across electrical circuits and cause damage to equipment, or severe burns or electrical shock to personnel.**

- Step 9. Turn battery disconnect switch to OFF position (WP 0007). Remove pump house panel S (WP 0540). Open pump house power distribution box (WP 0412). Remove circuit breaker P16 from pump house power distribution block (WP 0412). Check for continuity across circuit breaker.

If there is no continuity, replace circuit breaker P16 (WP 0412).

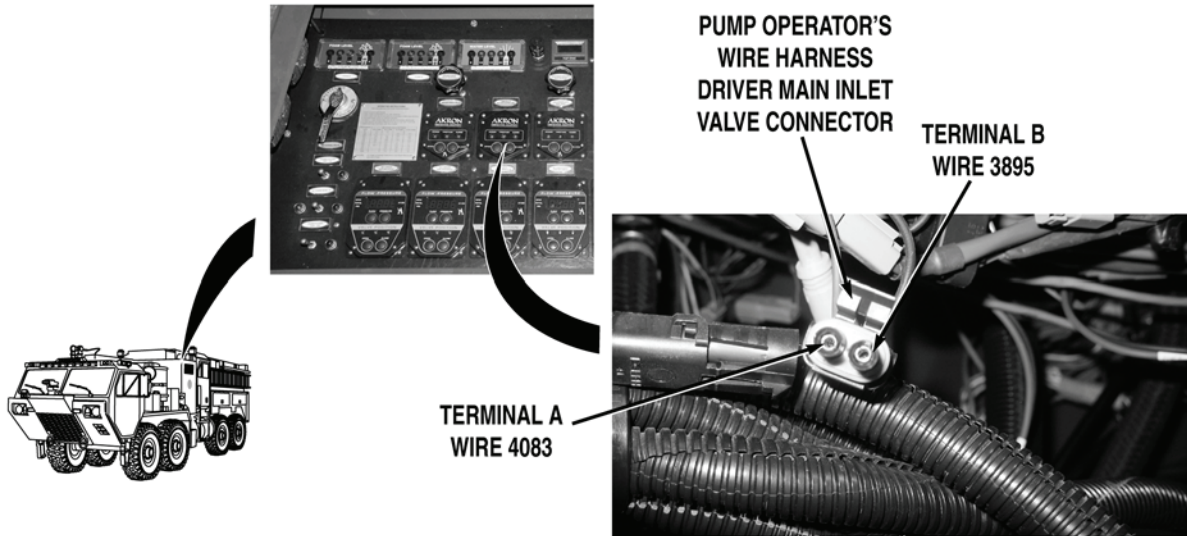
**MALFUNCTION****TEST OR INSPECTION****CORRECTIVE ACTION**

- Step 10. Install circuit breaker P7 (WP 0412). Open pump operator's panel housing (WP 0539). Disconnect pump operator's panel wire harness TANK FILL & RE-CIRCULATING LINE valve control connector. Turn battery disconnect switch to ON position (WP 0007). Check for 22 to 28 VDC between pump operator's panel wire harness wire 4083 (green) at TANK FILL & RE-CIRCULATING LINE valve control connector, terminal A and a known good ground.

If 22 to 28 VDC are not present, go to Step 12.

- Step 11. Turn battery disconnect switch to OFF position (WP 0007). Check for continuity across wire 3895 (black) from pump operator's panel TANK FILL & RE-CIRCULATING LINE valve control connector, terminal B and a known good ground.
- a. If there is continuity, replace TANK FILL & RE-CIRCULATING LINE valve control (WP 0418).
  - b. If there is no continuity, repair wire 3895 in pump operator's panel wire harness if repairable (TM 9-2320-325-14&P), or replace pump operator's panel wire harness (WP 0459).

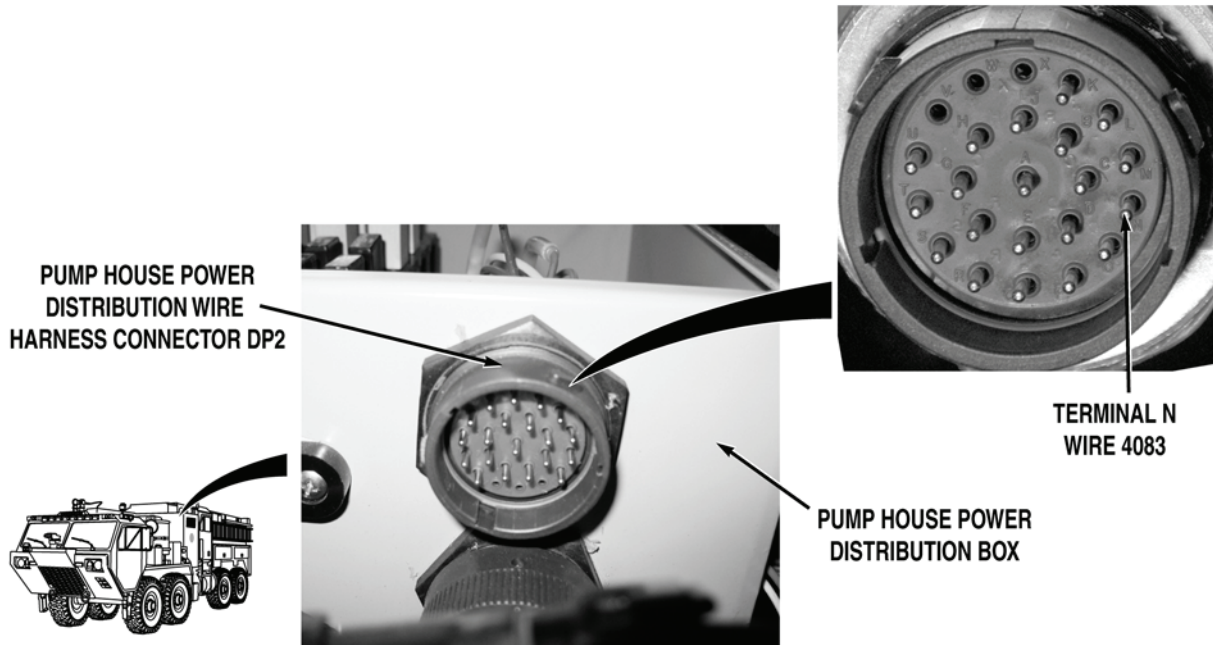
**MALFUNCTION****TEST OR INSPECTION****CORRECTIVE ACTION**

- Step 12. Disconnect pump operator's panel wire harness pump house power distribution wire harness connector DP2. With a test lead set, check for 22 to 28 VDC between pump house power distribution wire harness wire 4083 (green) at connector DP2, terminal N and a known good ground.
- a. If 22 to 28 VDC are present, repair wire 4083 in pump operator's panel wire harness if repairable (TM 9-2320-325-14&P), or replace pump operator's panel wire harness (WP 0459).
  - b. If 22 to 28 VDC are not present, repair wire 4083 in pump house power distribution wire harness if repairable (TM 9-2320-325-14&P), or replace pump house power distribution wire harness and block (WP 0457).

**END OF TASK****FOLLOW-ON MAINTENANCE**

Remove wheel chocks (TM 9-2320-347-10)

**END OF TASK****END OF WORK PACKAGE**

**FIELD LEVEL MAINTENANCE**

**TANK-TO-PUMP VALVE(S) DOES NOT OPERATE PROPERLY**

**INITIAL SETUP:**

**Tools and Special Tools**

Lead Set, Test (WP 0622, Item 21)  
 Tool Kit, General Mechanic's: Automotive  
 (WP 0622, Item 27)

**Personnel Required**

MOS 63B Wheeled vehicle mechanic (2)

**References**

TM 9-2320-325-14&P  
 WP 0004  
 WP 0007  
 WP 0311  
 WP 0315  
 WP 0325  
 WP 0338  
 WP 0398  
 WP 0402

**References (continued)**

WP 0427  
 WP 0441  
 WP 0443  
 WP 0455  
 WP 0459  
 WP 0463  
 WP 0493  
 WP 0494  
 WP 0499  
 WP 0539  
 WP 0540  
 WP 0550  
 WP 0567

**Equipment Conditions**

Water pump engine OFF (WP 0022)  
 Engine OFF (TM 9-2320-347-10)  
 Wheels chocked (TM 9-2320-347-10)

**MALFUNCTION**

**TEST OR INSPECTION**

**CORRECTIVE ACTION**

**TANK-TO-PUMP VALVE(S) DOES NOT OPERATE PROPERLY**



**GROUND SWEEPS  
 INDICATOR**

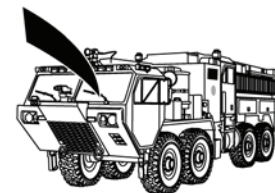

Step 1. Turn battery disconnect switch to ON position (WP 0007). Put GROUND SWEEPS switch to on position (WP 0004). Check if GROUND SWEEPS indicator illuminates.

If GROUND SWEEPS indicator does not illuminate, go to Step 43.

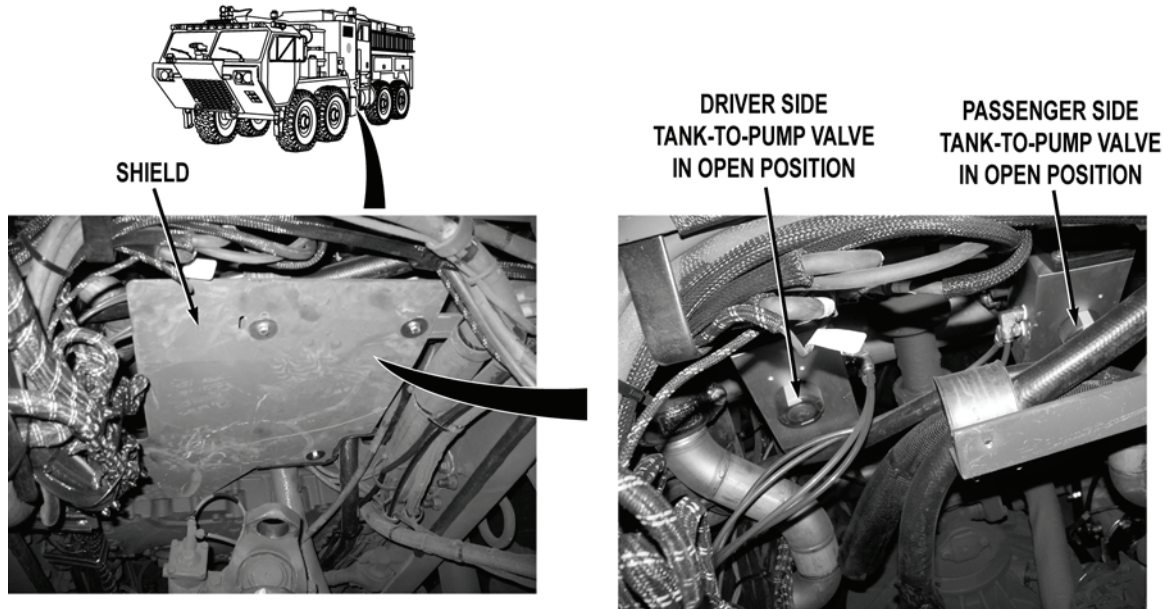
**MALFUNCTION****TEST OR INSPECTION****CORRECTIVE ACTION****NOTE**

- Ensure system air pressure is at least 85 psi (586 kPa) during this procedure. System air pressure is required to activate valves.
- Do not engage water pump engine during this procedure, except when performing complete system checks. Valve operations can be checked without water pump operation.
- Valve operations can be checked by observing valve shaft rotation. Valves are open when tabs or yellow paint tabs are aligned with direction of fluid flow.

Step 2. If system air pressure is below 85 psi (586 kPa), start vehicle engine and allow system air pressure to build to at least 85 psi (586 kPa) (TM 9-2320-347-10). Shut vehicle engine off (TM 9-2320-347-10). Remove shield (WP 0493). While an assistant puts and holds pump operator's panel TANK TO PUMP switch to OPEN position (WP 0004), check if tank-to-pump valves operate to open position.

If tank-to-pump valves operate to open position, go to Step 26.

Step 3. Check if tank-to-pump valves remain in open position after assistant releases pump operator's panel TANK TO PUMP switch (WP 0004).

If tank-to-pump valves do not remain in open position, go to Step 17.

---

**MALFUNCTION****TEST OR INSPECTION****CORRECTIVE ACTION**

---

- Step 4. While an assistant puts pump operator's panel TANK TO PUMP switch to CLOSED position (WP 0004), check if tank-to-pump valves operate to closed position.
- If tank-to-pump valves do not operate to closed position, go to Step 10.
- Step 5. Release pump operator's panel TANK TO PUMP switch (WP 0004). While an assistant puts cab TANK TO PUMP switch to open position (WP 0004), check if tank-to-pump valves operate to open position.
- If tank-to-pump valves do not operate to open position, go to Step 8.
- Step 6. While an assistant puts cab TANK TO PUMP switch to closed position (WP 0004), check if tank-to-pump valves operate to closed position.
- If tank-to-pump valves operate to closed position, fault corrected.

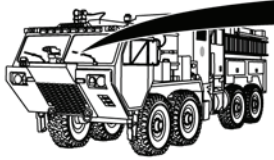
**MALFUNCTION****TEST OR INSPECTION****CORRECTIVE ACTION**

TANK TO PUMP  
SWITCH

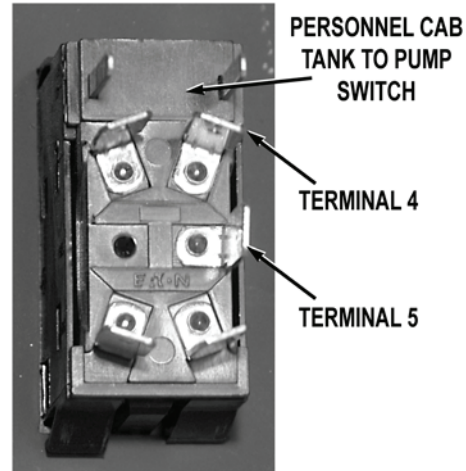
**WARNING**

**Remove rings, wristwatches, neck chains, and any other jewelry before working around vehicle. Jewelry can catch on equipment and cause serious injury. Jewelry and tools may short across electrical circuits and cause damage to equipment, or severe burns or electrical shock to personnel.**

- Step 7. Turn battery disconnect switch to OFF position (WP 0007). Remove cab instrument panel B (WP 0311). Disconnect cab pump control wire harness PUMP TO TANK switch connector. Check for continuity across TANK TO PUMP switch, from terminal 5 to terminal 4, when switch is in closed position.
- a. If there is continuity, repair wire 2770 (blue) in cab pump control wire harness if repairable (TM 9-2320-325-14&P), or replace cab pump control wire harness (WP 0443).
  - b. If there is no continuity, replace cab TANK TO PUMP switch (WP 0315).



**MALFUNCTION**

**TEST OR INSPECTION**

**CORRECTIVE ACTION**

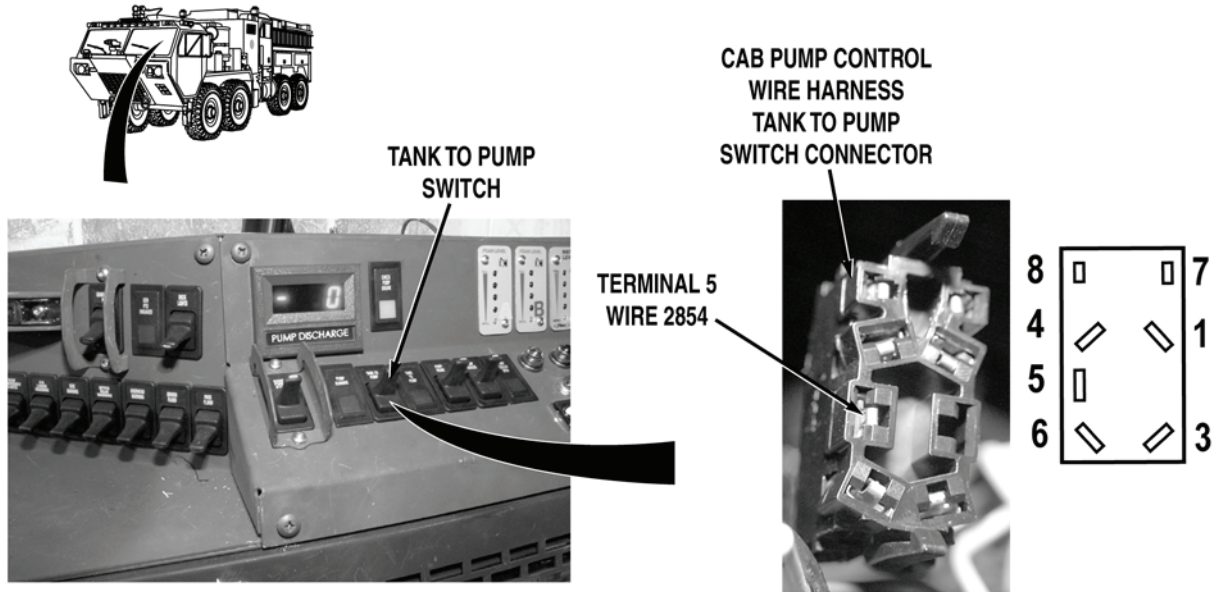

**WARNING**



**Remove rings, wristwatches, neck chains, and any other jewelry before working around vehicle. Jewelry can catch on equipment and cause serious injury. Jewelry and tools may short across electrical circuits and cause damage to equipment, or severe burns or electrical shock to personnel.**

Step 8. Release pump operator's panel TANK TO PUMP switch (WP 0004). Remove cab instrument panel B (WP 0311). Disconnect cab pump control wire harness TANK TO PUMP switch connector. Check for 22 to 28 VDC between cab pump control wire harness wire 2854 (red) at TANK TO PUMP switch connector, terminal 5 and a known good ground.

If 22 to 28 VDC are not present, repair wire 2854 in cab pump control wire harness if repairable (TM 9-2320-325-14&P), or replace cab pump control wire harness (WP 0443).

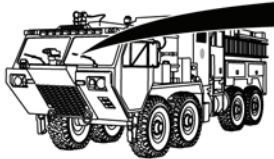
**MALFUNCTION****TEST OR INSPECTION****CORRECTIVE ACTION**

TANK TO PUMP  
SWITCH

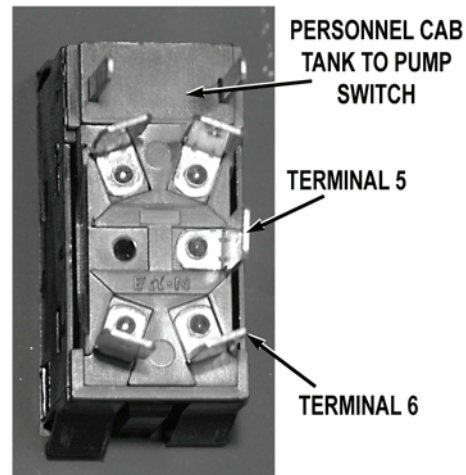

- Step 9. Turn battery disconnect switch to OFF position (WP 0007). While an assistant holds cab TANK TO PUMP switch in on position, check for continuity across TANK TO PUMP switch, from terminal 5 to terminal 6.
- a. If there is continuity, repair wire 2855 in cab pump control wire harness if repairable (TM 9-2320-325-14&P), or replace cab pump control wire harness (WP 0443).
  - b. If there is no continuity, replace cab TANK TO PUMP switch (WP 0315).

**NOTE**

- Ensure system air pressure is at least 85 psi (586 kPa) during this procedure. System air pressure is required to activate valves.
- Do not engage water pump engine during this procedure, except when performing complete system checks. Valve operations can be checked without water pump operation.
- Valve operations can be checked by observing valve shaft rotation. Valves are open when tabs or yellow paint tabs are aligned with direction of fluid flow.

- Step 10. Release pump operator's panel TANK TO PUMP switch (WP 0004). While an assistant puts cab TANK TO PUMP switch to closed position (WP 0004), check if tank-to-pump valves operate to closed position.

If tank-to-pump valve does not operate to closed position, go to Step 14.

---

**MALFUNCTION**  
**TEST OR INSPECTION**  
**CORRECTIVE ACTION**

---

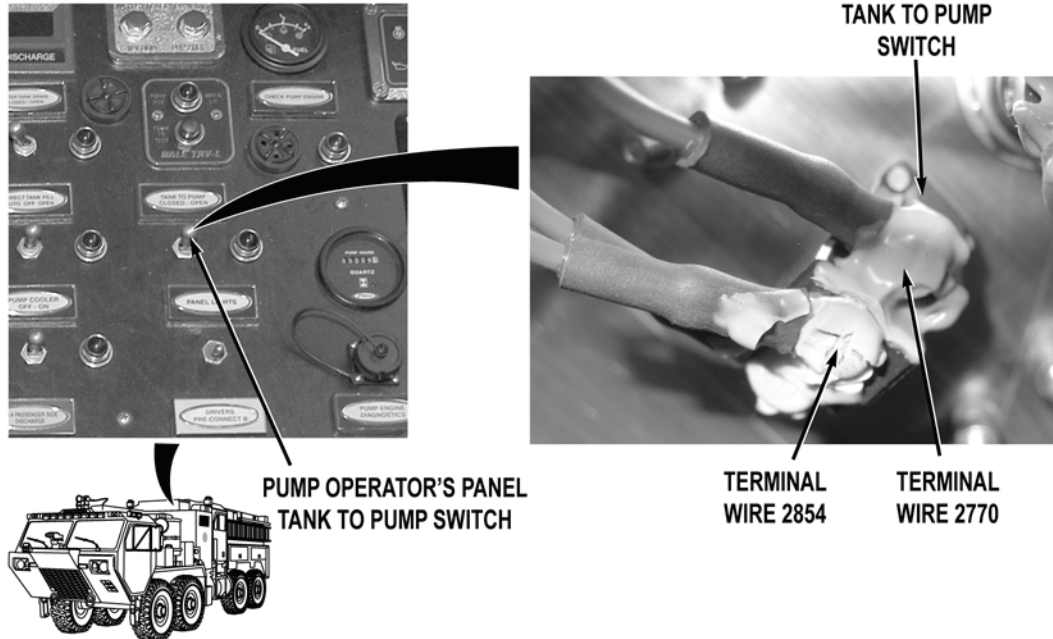

**WARNING**



Remove rings, wristwatches, neck chains, and any other jewelry before working around vehicle. Jewelry can catch on equipment and cause serious injury. Jewelry and tools may short across electrical circuits and cause damage to equipment, or severe burns or electrical shock to personnel.

- Step 11. Release cab TANK TO PUMP switch (WP 0004). Turn battery disconnect switch to OFF position (WP 0007). Open pump operator's panel housing (WP 0325). While an assistant puts pump operator's panel TANK TO PUMP switch to closed position (WP 0004), check for continuity across pump operator's panel TANK TO PUMP switch, from terminal wire 2854 (red) to terminal wire 2770 (blue).

If there is no continuity, replace pump operator's panel TANK TO PUMP switch (WP 0338).

**MALFUNCTION**

**TEST OR INSPECTION**

**CORRECTIVE ACTION**

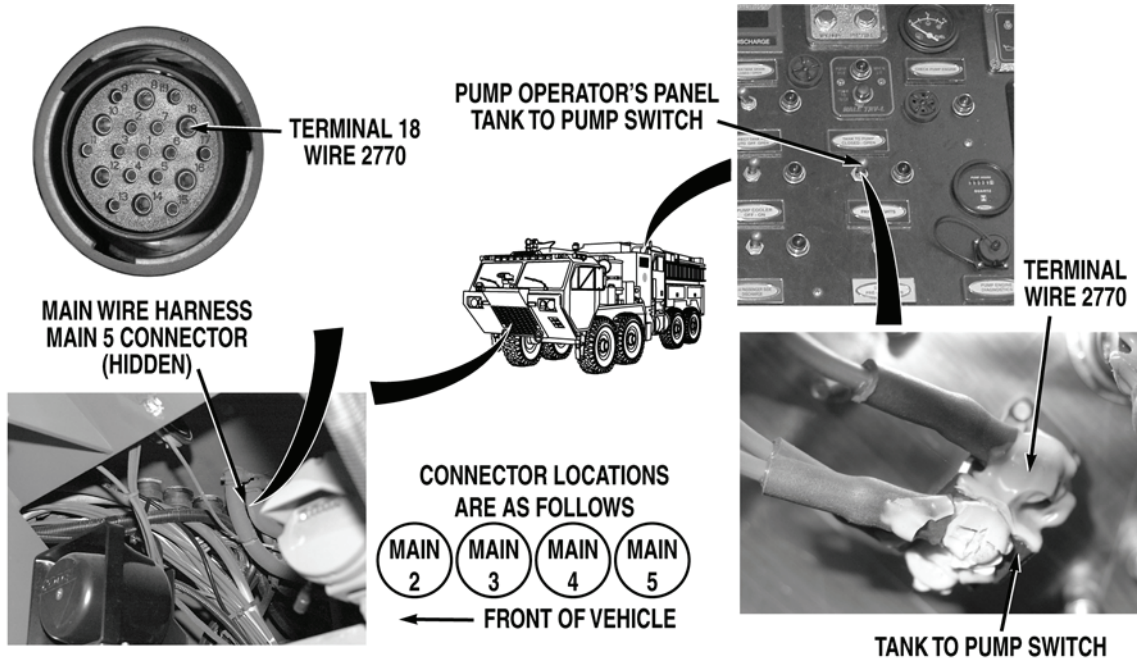

Step 12. Remove skid plate grille (WP 0550). Disconnect main wire harness main 5 wire harness connector. With a test lead set, check for continuity across wire 2770 (blue) from pump operator's panel TANK TO PUMP switch terminal to main wire harness main 5 wire harness connector, terminal 18.

If there is continuity, repair wire 2770 in cab pump control wire harness if repairable (TM 9-2320-325-14&P), or replace cab pump control wire harness (WP 0443).

**MALFUNCTION**  
**TEST OR INSPECTION**  
**CORRECTIVE ACTION**

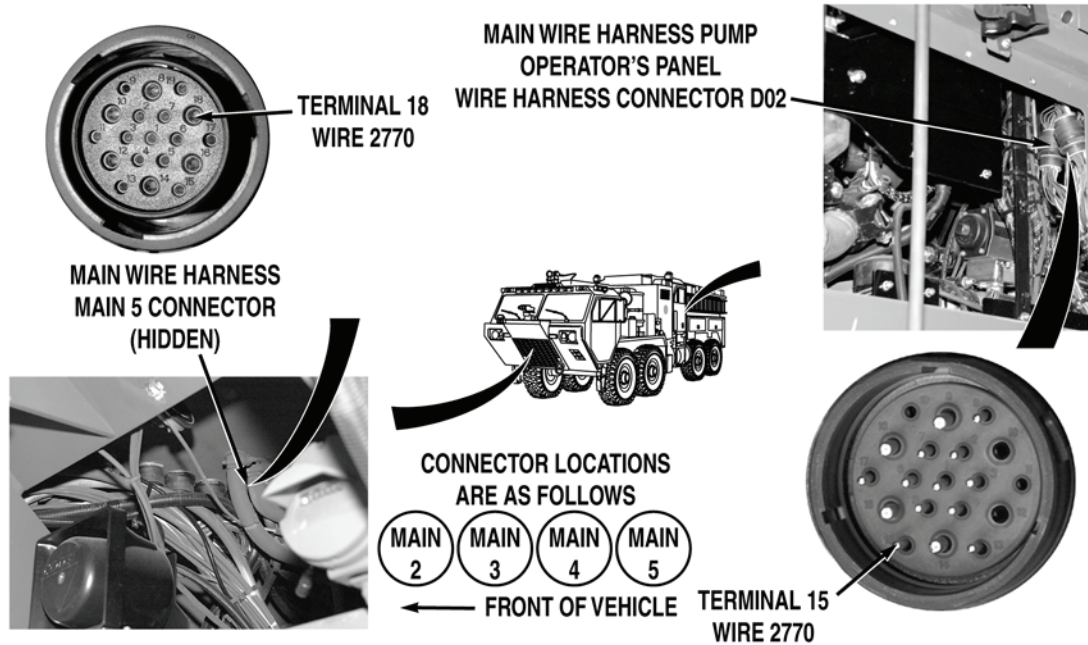

- Step 13. Remove crew cab access panel (WP 0499). Remove pump house panel Q (WP 0540). Disconnect main wire harness pump operator's panel wire harness connector DO2. With a test lead set, check for continuity across main wire harness wire 2770 (blue) from main wire harness pump operator's panel wire harness connector DO2, terminal 15 to main wire harness main 5 wire harness connector, terminal 18.
- a. If there is continuity, repair wire 2770 in pump operator's panel wire harness if repairable (TM 9-2320-325-14&P), or replace pump operator's panel wire harness (WP 0459).
  - b. If there is no continuity, repair wire 2770 in main wire harness if repairable (TM 9-2320-325-14&P), or replace main wire harness (WP 0455).

## MALFUNCTION

## TEST OR INSPECTION

## CORRECTIVE ACTION

## CAB POWER DISTRIBUTION BLOCK

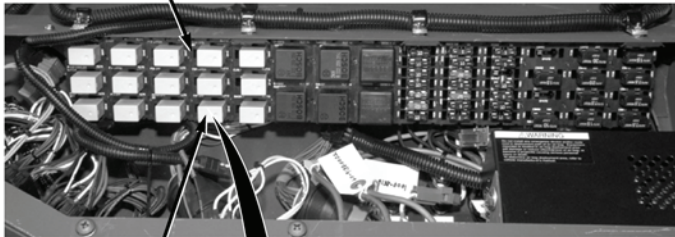

## RELAY 12

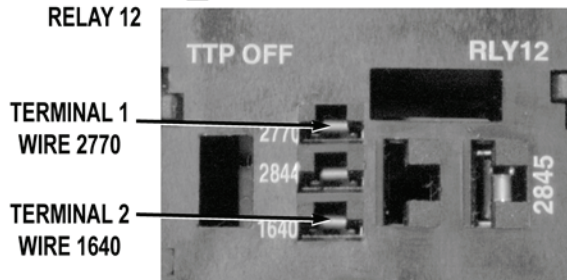

TERMINAL 1

WIRE 2770

TERMINAL 2

WIRE 1640

**WARNING**

Remove rings, wristwatches, neck chains, and any other jewelry before working around vehicle. Jewelry can catch on equipment and cause serious injury. Jewelry and tools may short across electrical circuits and cause damage to equipment, or severe burns or electrical shock to personnel.

- Step 14. Release TANK TO PUMP switch (WP 0004). Remove cab instrument panel A (WP 0311). Remove relay 12 (WP 0402). While an assistant puts cab TANK TO PUMP switch to close position (WP 0004), check for 22 to 28 VDC between cab power distribution wire harness wire 2770 (blue) at relay 12 connector, terminal 1 and a known good ground.

If 22 to 28 VDC are not present, go to Step 16.

- Step 15. Turn battery disconnect switch to OFF position (WP 0007). Check for continuity across cab power distribution wire harness wire 1640 (black) from relay 12 connector, terminal 2 to a known good ground.
- a. If there is continuity, replace relay 12 (WP 0402).
  - b. If there is no continuity, replace cab power distribution wire harness and block (WP 0441).

**MALFUNCTION**  
**TEST OR INSPECTION**  
**CORRECTIVE ACTION**

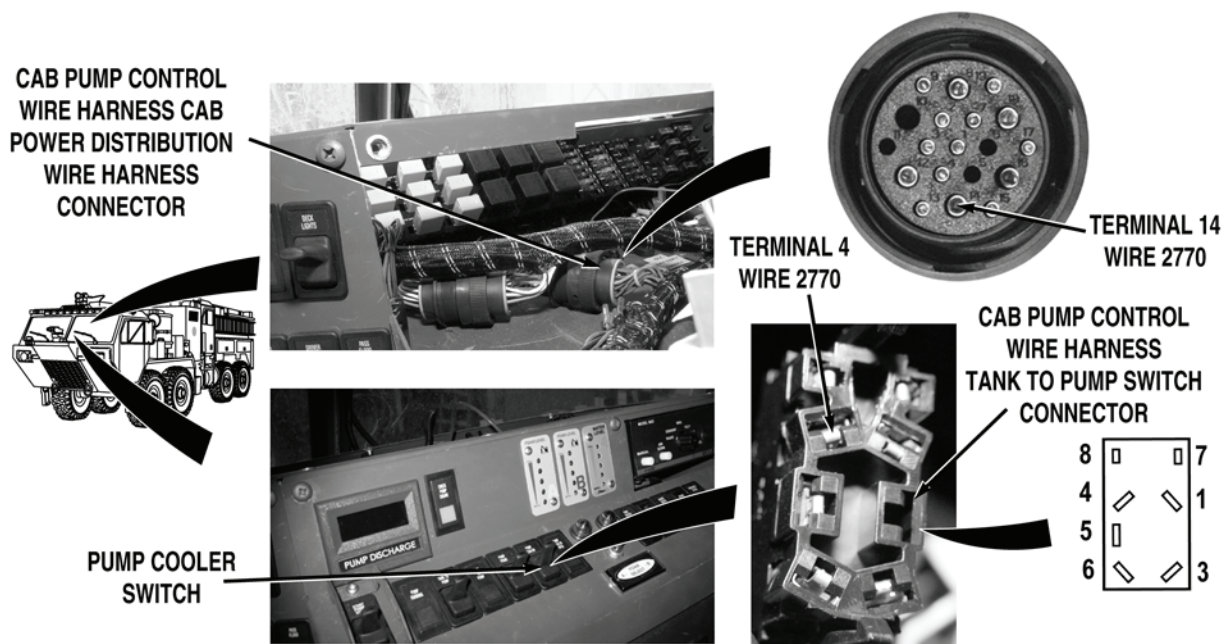

- Step 16. Turn battery disconnect switch to OFF position (WP 0007). Disconnect cab pump control wire harness cab power distribution wire harness connector. With a test lead set, check for continuity across cab pump control wire harness wire 2770 (blue) from cab pump control wire harness TANK TO PUMP switch connector, terminal 4 to cab pump control wire harness cab power distribution wire harness connector, terminal 14.
- a. If there is continuity, repair wire 2770 in cab power distribution wire harness if repairable (TM 9-2320-325-14&P), or replace cab power distribution wire harness and block (WP 0441).
  - b. If there is no continuity, repair wire 2770 in cab pump control wire harness if repairable (TM 9-2320-325-14&P), or replace cab pump control wire harness (WP 0443).

- Step 17. While an assistant puts cab TANK TO PUMP switch to open position (WP 0004), check if tank-to-pump valve operates to open position.

If tank-to-pump valve operates to open position, go to Step 25.

## MALFUNCTION

## TEST OR INSPECTION

## CORRECTIVE ACTION

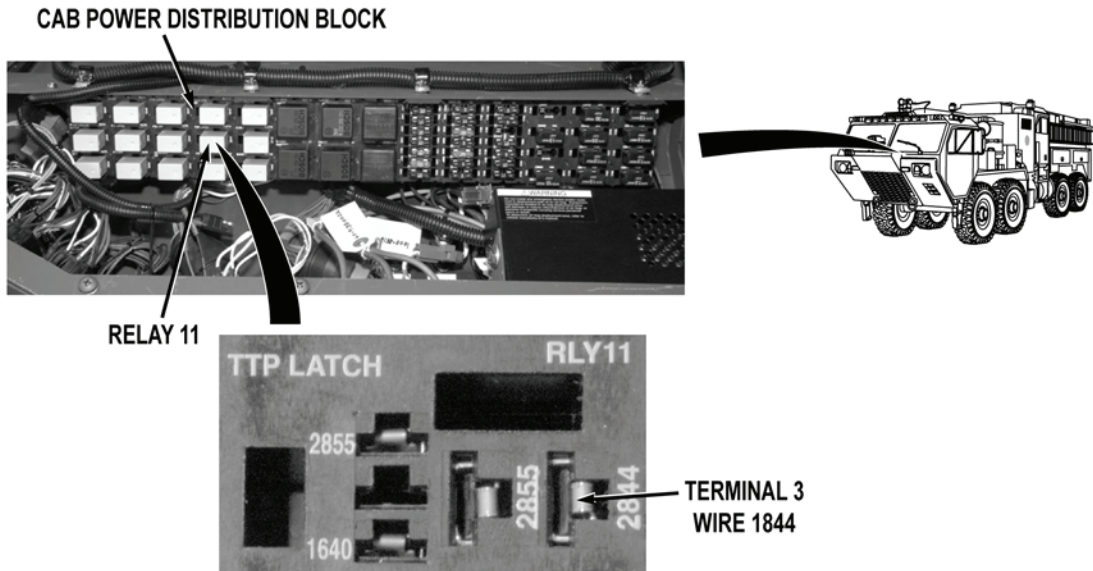
**WARNING**

**Remove rings, wristwatches, neck chains, and any other jewelry before working around vehicle. Jewelry can catch on equipment and cause serious injury. Jewelry and tools may short across electrical circuits and cause damage to equipment, or severe burns or electrical shock to personnel.**

- Step 18. Put cab TANK TO PUMP switch to closed position (WP 0004). Turn battery disconnect switch to OFF position (WP 0007). Remove cab instrument panel A (WP 0311). Remove relay 11 (WP 0402). Turn battery disconnect switch to ON position (WP 0007). Check for 22 to 28 VDC between cab power distribution wire harness wire 2844 (white) at relay 11 connector, terminal 3 and a known good ground.

If 22 to 28 VDC are not present, go to Step 23.



---

**MALFUNCTION**  
**TEST OR INSPECTION**  
**CORRECTIVE ACTION**

---

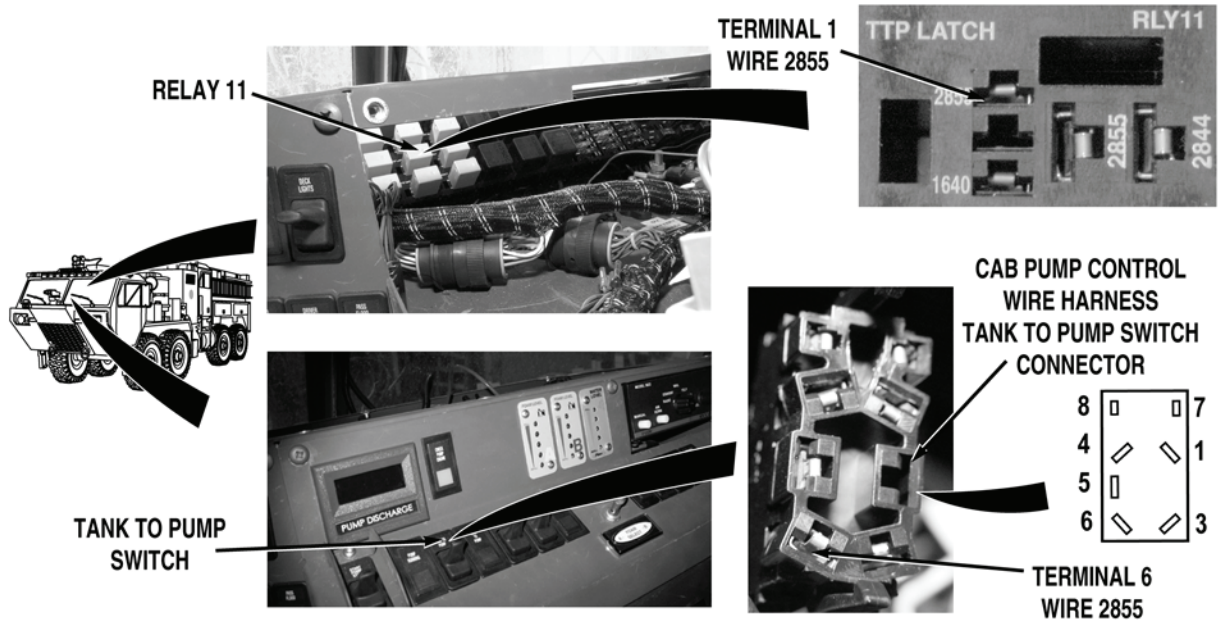

Step 19. Turn battery disconnect switch to OFF position (WP 0007). Check for continuity across wire 2855 (red) from cab pump control wire harness TANK TO PUMP switch connector, terminal 6 to cab power distribution wire harness relay 11 connector, terminal 1.

If there is no continuity, go to Step 22.

**MALFUNCTION**

**TEST OR INSPECTION**

**CORRECTIVE ACTION**

**CAB POWER DISTRIBUTION BLOCK**

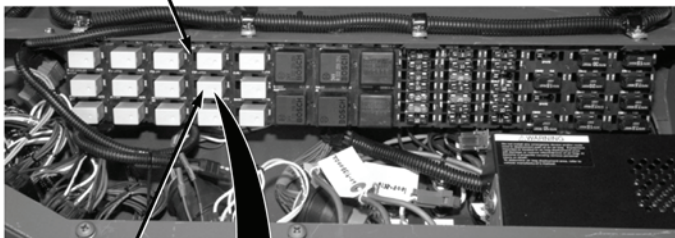

**RELAY 11**

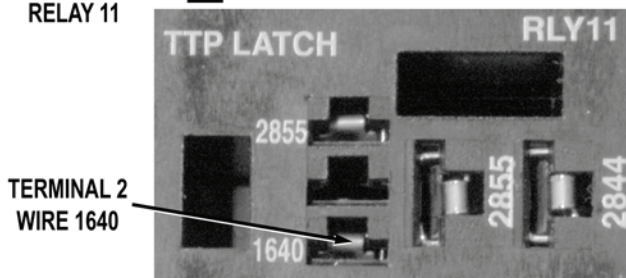

Step 20. Check for continuity across cab power distribution wire harness wire 1640 (black) from relay 11 connector, terminal 2 to a known good ground.

If there is no continuity, replace cab power distribution wire harness and block (WP 0441).

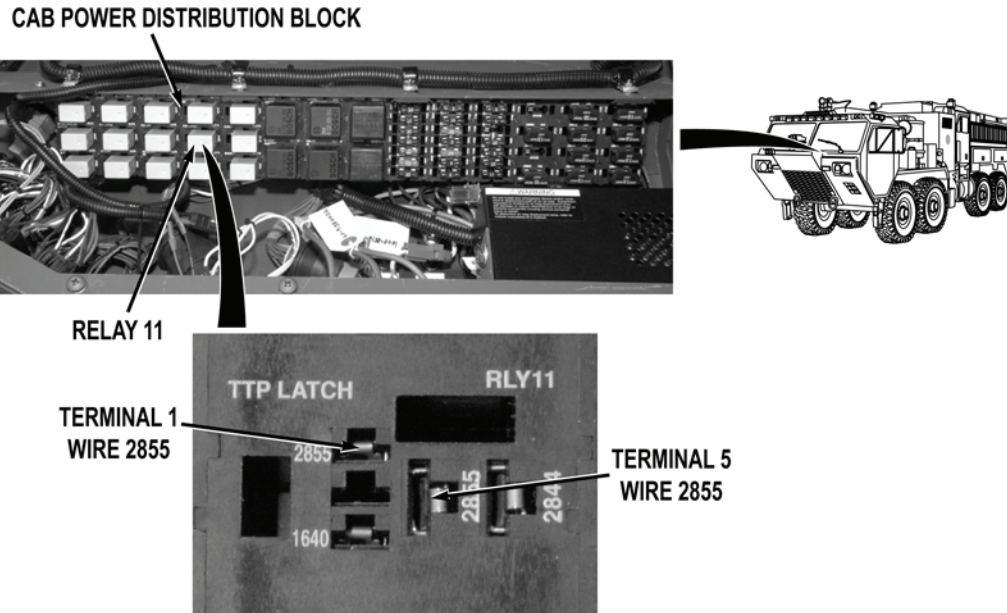
**MALFUNCTION****TEST OR INSPECTION****CORRECTIVE ACTION**

- Step 21. Check for continuity across cab power distribution wire harness wire 2855 (red) from relay 11 connector, terminal 1 to relay 11 connector, terminal 5.
- a. If there is continuity, replace relay 11 (WP 0402).
  - b. If there is no continuity, replace cab power distribution wire harness and block (WP 0441).

**MALFUNCTION**

**TEST OR INSPECTION**

**CORRECTIVE ACTION**



**WARNING**



**Remove rings, wristwatches, neck chains, and any other jewelry before working around vehicle. Jewelry can catch on equipment and cause serious injury. Jewelry and tools may short across electrical circuits and cause damage to equipment, or severe burns or electrical shock to personnel.**

- Step 22. Remove cab instrument panel B (WP 0311). Disconnect cab pump control wire harness cab power distribution wire harness connector. With a test lead set, check for continuity across cab pump control wire harness wire 2855 (red) from cab pump control wire harness TANK TO PUMP switch connector, terminal 6 to cab pump control wire harness cab power distribution wire harness connector, terminal 13.
- a. If there is continuity, repair wire 2855 in cab power distribution wire harness if repairable (TM 9-2320-325-14&P), or replace cab power distribution wire harness and block (WP 0441).
  - b. If there is no continuity, repair wire 2855 in cab pump control wire harness if repairable (TM 9-2320-325-14&P), or replace cab pump control wire harness (WP 0443).

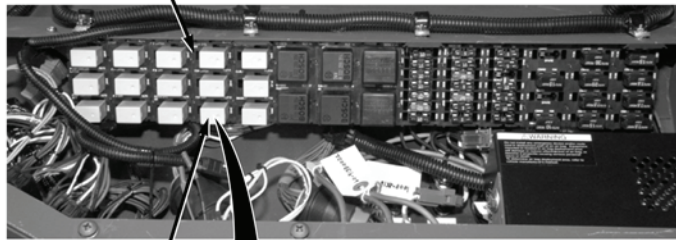
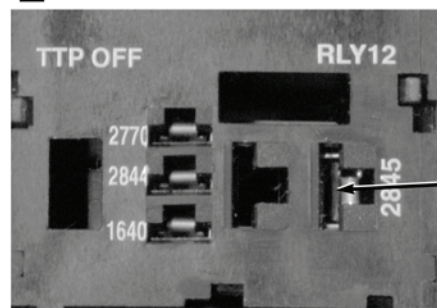
**MALFUNCTION****TEST OR INSPECTION****CORRECTIVE ACTION****CAB POWER DISTRIBUTION BLOCK****RELAY 12****TERMINAL 3  
WIRE 2854****WARNING**

**Remove rings, wristwatches, neck chains, and any other jewelry before working around vehicle. Jewelry can catch on equipment and cause serious injury. Jewelry and tools may short across electrical circuits and cause damage to equipment, or severe burns or electrical shock to personnel.**

- Step 23. Turn battery disconnect switch to OFF position (WP 0007). Remove relay 12 (WP 0402). Turn battery disconnect switch to ON position (WP 0007). Check for 22 to 28 VDC between cab power distribution wire harness wire 2854 (red) at relay 12 connector, terminal 3 and a known good ground.

If 22 to 28 VDC are not present, replace cab power distribution wire harness and block (WP 0441).

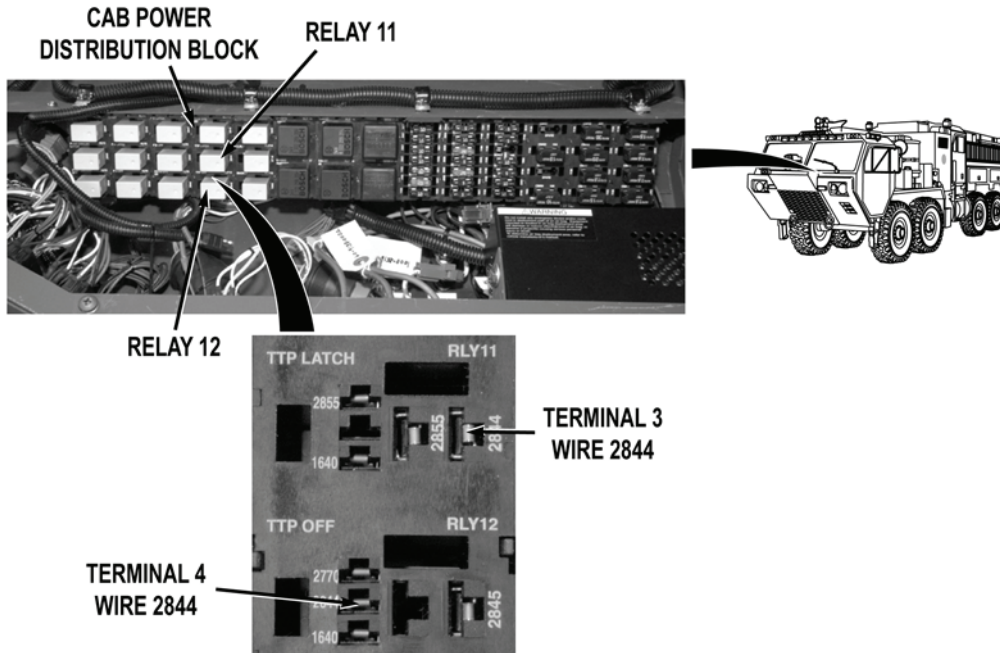
**MALFUNCTION****TEST OR INSPECTION****CORRECTIVE ACTION**

- Step 24. Turn battery disconnect switch to OFF position (WP 0007). Check for continuity across cab power distribution wire harness wire 2844 (white) from relay 12 connector, terminal 4 to relay 11 connector, terminal 3.
- a. If there is continuity, replace relay 12 (WP 0402).
  - b. If there is no continuity, replace cab power distribution wire harness and block (WP 0441).

**MALFUNCTION**

**TEST OR INSPECTION**

**CORRECTIVE ACTION**

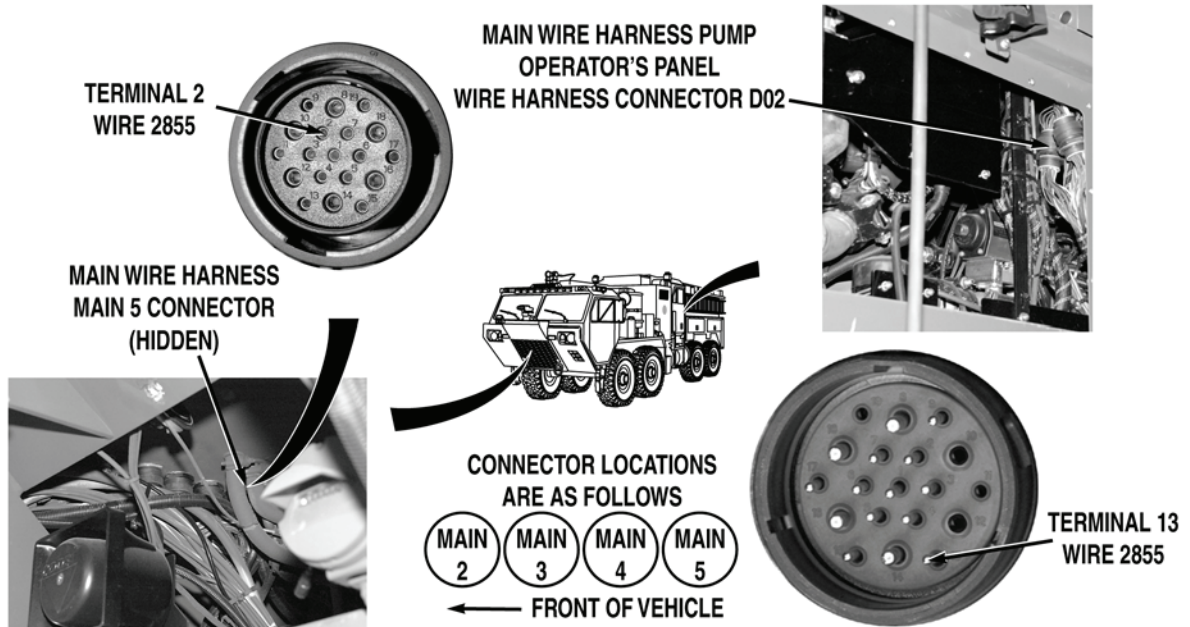

**WARNING**



**Remove rings, wristwatches, neck chains, and any other jewelry before working around vehicle. Jewelry can catch on equipment and cause serious injury. Jewelry and tools may short across electrical circuits and cause damage to equipment, or severe burns or electrical shock to personnel.**

- Step 25. Turn battery disconnect switch to OFF position (WP 0007). Remove skid plate grille (WP 0550). Disconnect main wire harness pump operator's panel wire harness connector DO2. Disconnect main wire harness main 5 wire harness connector. With a test lead set check for continuity across main wire harness wire 2855 (red) from main wire harness pump operator's panel wire harness connector DO2, terminal 13 to main wire harness main 5 wire harness connector, terminal 2.
- a. If there is continuity, repair wire 2855 in cab pump control wire harness if repairable (TM 9-2320-325-14&P), or replace cab pump control wire harness (WP 0443).
  - b. If there is no continuity, repair wire 2855 in main wire harness if repairable (TM 9-2320-325-14&P), or replace main wire harness (WP 0455).

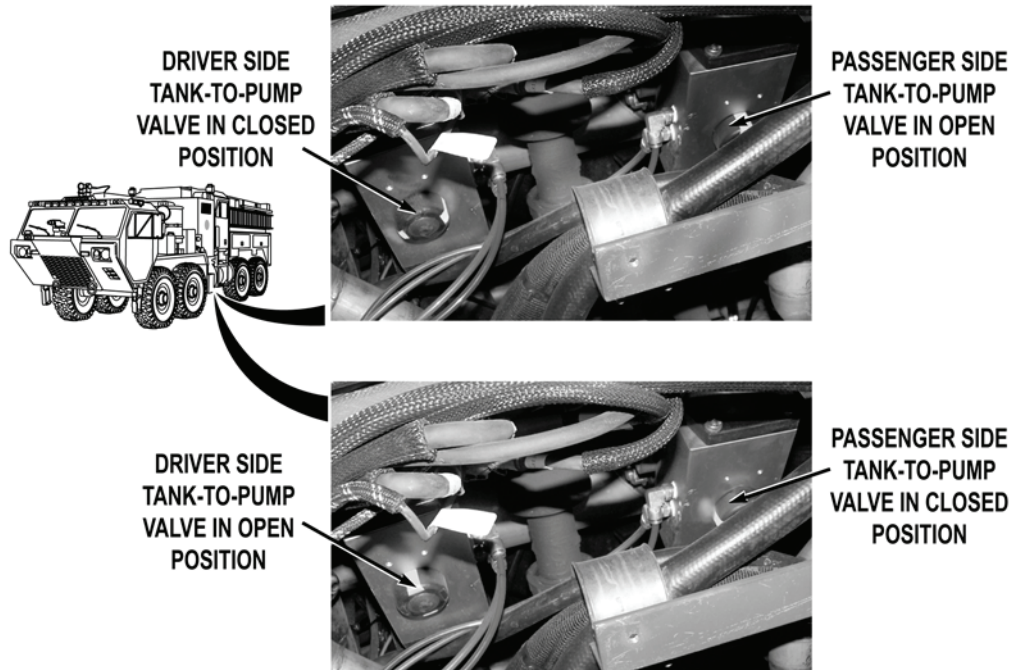
**MALFUNCTION****TEST OR INSPECTION****CORRECTIVE ACTION****NOTE**

- Ensure system air pressure is at least 85 psi (586 kPa) during this procedure. System air pressure is required to activate valves.
- Do not engage water pump engine during this procedure, except when performing complete system checks. Valve operations can be checked without water pump operation.
- Valve operations can be checked by observing valve shaft rotation. Valves are open when tabs or yellow paint tabs are aligned with direction of fluid flow.

Step 26. Put pump operator's panel TANK TO PUMP switch to CLOSED position (WP 0004). While an assistant puts cab TANK TO PUMP switch to open position (WP 0004), check if tank-to-pump valves operate to open position.

If both tank-to-pump valves do not operate to open position, go to Step 36.

Step 27. While an assistant holds cab TANK TO PUMP switch in on position. Check if driver side or passenger side tank-to-pump valves operate to open position.

If passenger side tank-to-pump valve does not operate, go to Step 32.



**MALFUNCTION**

**TEST OR INSPECTION**

**CORRECTIVE ACTION**

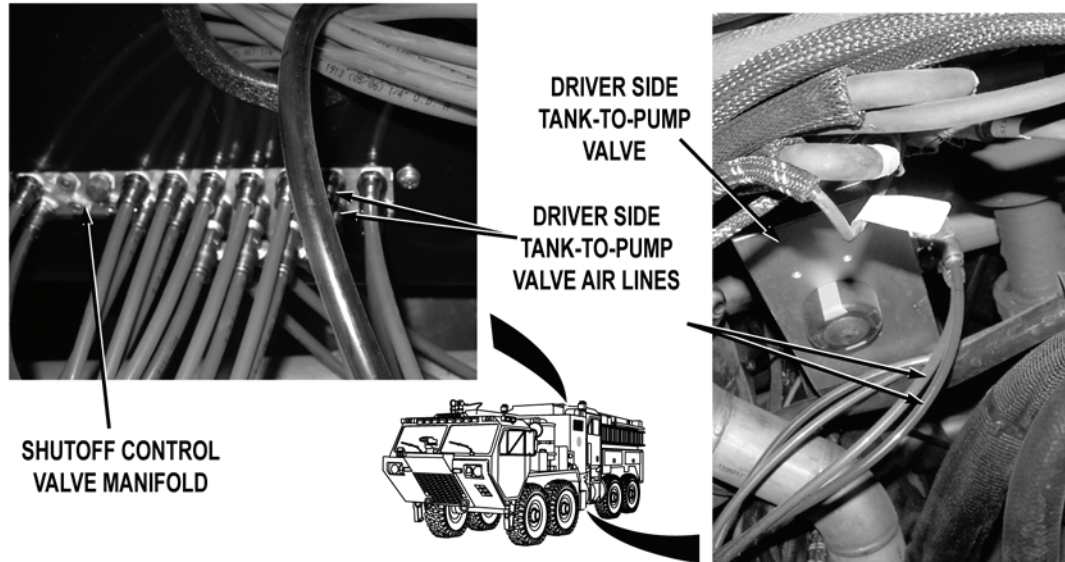

Step 28. Open pump house panel A (WP 0539). Inspect driver side tank-to-pump air lines from shutoff control valve manifold to driver side tank-to-pump valve for leaks, kinks, or damage.

If air lines are not free from leaks, kinks, or damage, replace damaged air lines (WP 0567).

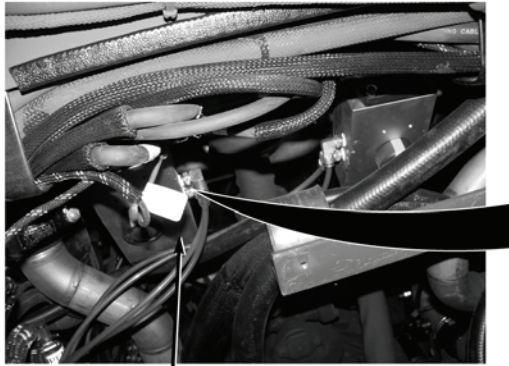
**MALFUNCTION****TEST OR INSPECTION****CORRECTIVE ACTION**

**DRIVER SIDE  
TANK-TO-PUMP  
VALVE**

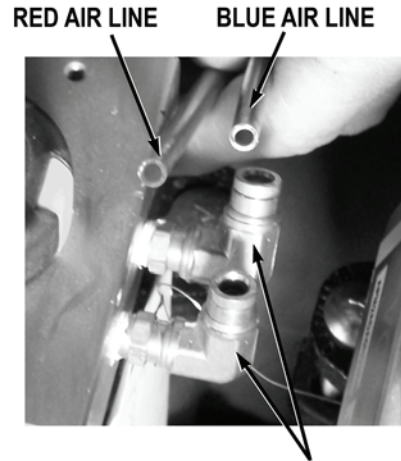

**RED AIR LINE**

**BLUE AIR LINE**

**ELBOWS**

**WARNING**

**Air lines may be under pressure when shutoff control valve manifold is operated. If under pressure and air lines are disconnected, air lines may whip around and cause injury to personnel. Caution should be exercised when operating control valve with air lines disconnected. Failure to comply may cause injury to personnel.**

**NOTE**

Air pressure is checked by disconnecting air lines at driver side tank-to-pump valve and observing air pressure escaping from air lines. Air will escape from blue air line when TANK TO PUMP switch is put to on position (WP 0004), and escape from red air line when TANK TO PUMP switch is put to off position (WP 0004). System air pressure may drop below 85 psi (586 kPa) during this procedure.

- Step 29. Disconnect red and blue air lines from two elbows. While an assistant puts cab or pump operator's panel TANK TO PUMP switch to on position (WP 0004), check if air pressure is present at blue air line.

If there is air pressure, replace driver side tank-to-pump valve (WP 0493).

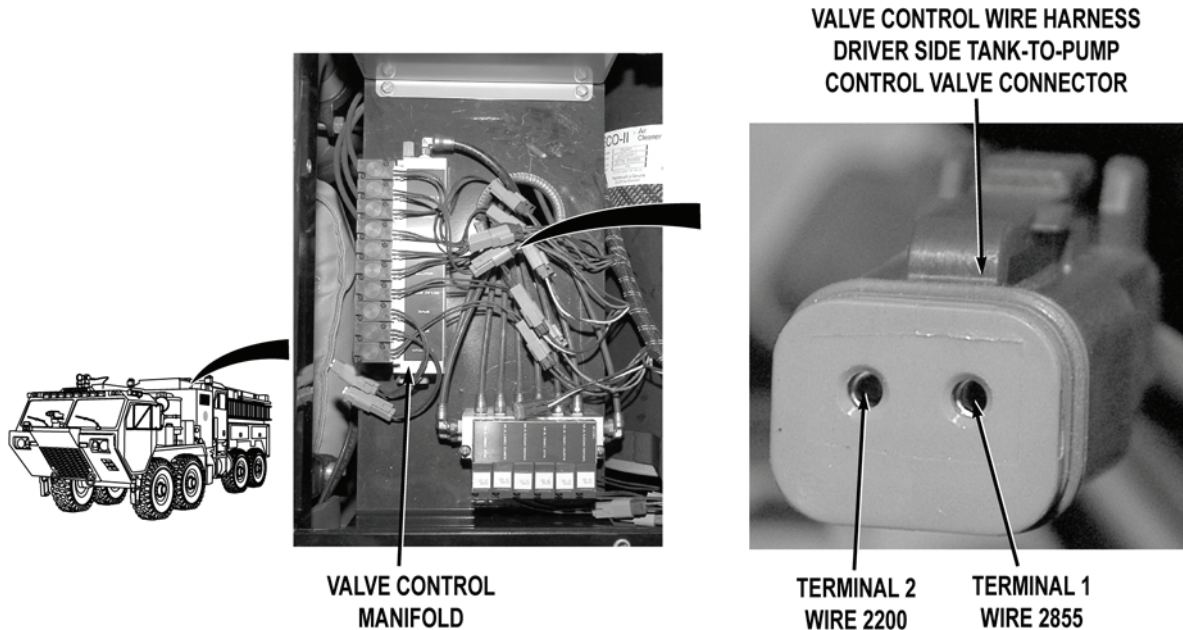
**MALFUNCTION****TEST OR INSPECTION****CORRECTIVE ACTION**

- Step 30. Connect red and blue air lines on two elbows. Disconnect valve control wire harness driver side tank-to-pump control valve connector. Have an assistant put cab or pump operator's panel TANK TO PUMP switch to on position (WP 0004). With a test lead set, check for 22 to 28 VDC between valve control wire harness wire 2855 (red) at valve control wire harness driver side tank-to-pump control valve connector, terminal 1 and a known good ground.

If 22 to 28 VDC are not present, repair wire 2855 in valve control wire harness if repairable (TM 9-2320-325-14&P), or replace valve control wire harness (WP 0463).

- Step 31. Put cab or pump operator's panel TANK TO PUMP switch to off position (WP 0004). Turn battery disconnect switch to OFF position (WP 0007). Check for continuity across valve control wire harness wire 2200 (black) from valve control wire harness driver side tank-to-pump control valve connector, terminal 2 to a known good ground.
- a. If there is continuity, replace shutoff control valve manifold (WP 0427).
  - b. If there is no continuity, repair wire 2200 in valve control wire harness if repairable (TM 9-2320-325-14&P), or replace valve control wire harness (WP 0463).

**MALFUNCTION**

**TEST OR INSPECTION**

**CORRECTIVE ACTION**

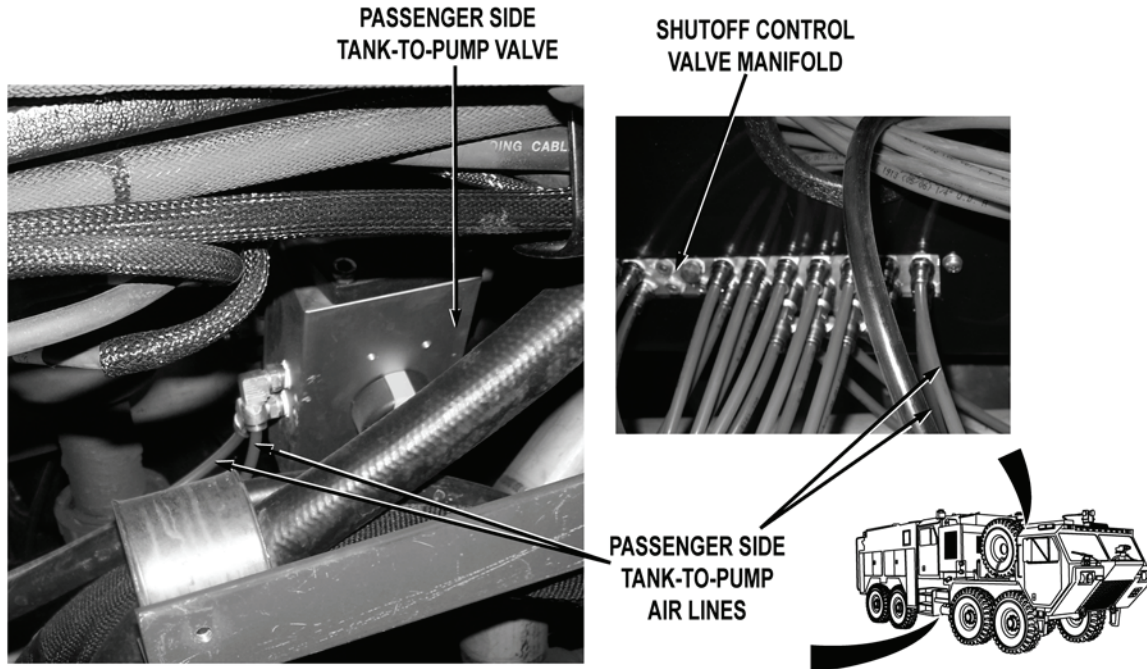

Step 32. Open pump house panel A (WP 0539). Inspect passenger side tank-to-pump air lines from shutoff control valve manifold to passenger side tank-to-pump valve for leaks, kinks, or damage.

If air lines are not free from leaks, kinks, or damage, replace damaged air lines (WP 0567).

---

<b>MALFUNCTION</b>	<b>TEST OR INSPECTION</b>	<b>CORRECTIVE ACTION</b>
--------------------	---------------------------	--------------------------

---

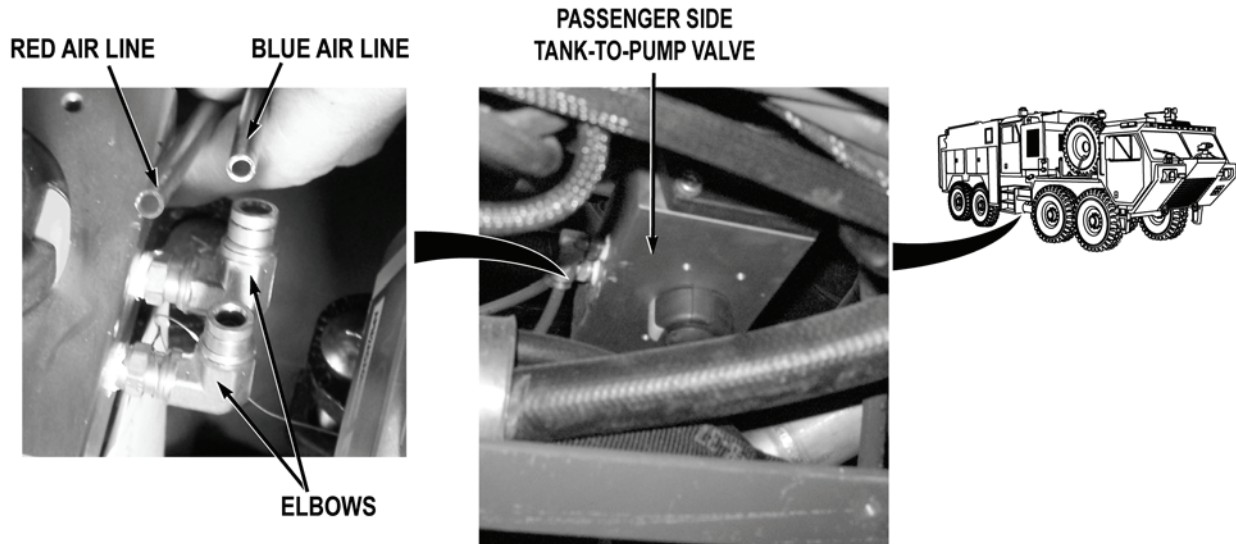
**WARNING**

**Air lines may be under pressure when shutoff control valve manifold is operated. If under pressure and air lines are disconnected, air lines may whip around and cause injury to personnel. Caution should be exercised when operating control valve with air lines disconnected. Failure to comply may cause injury to personnel.**

**NOTE**

Air pressure is checked by disconnecting air lines at passenger side tank-to-pump valve and observing air pressure escaping from air lines. Air will escape from blue air line when TANK TO PUMP switch is put to on position (WP 0004), and escape from red air line when TANK TO PUMP switch is put to off position (WP 0004). System air pressure may drop below 85 psi (586 kPa) during this procedure.

- Step 33. Disconnect air lines from two elbows. While an assistant puts cab or pump operator's panel TANK TO PUMP switch to on position (WP 0004), check if air pressure is present at blue air line.

If there is air pressure, replace passenger side tank-to-pump valve (WP 0494).

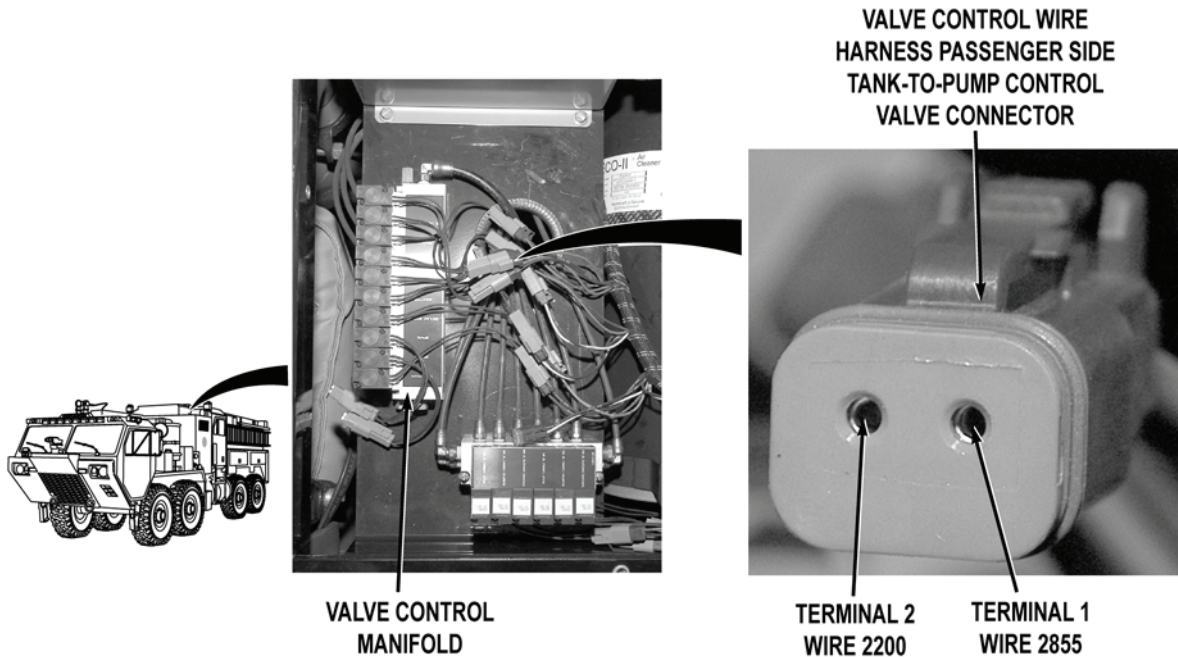
**MALFUNCTION****TEST OR INSPECTION****CORRECTIVE ACTION**

- Step 34. Connect red and blue air lines on two elbows. Disconnect valve control wire harness passenger side tank-to-pump control valve connector. Have an assistant put cab or pump operator's panel TANK TO PUMP switch to on position (WP 0004). With a test lead set, check for 22 to 28 VDC between valve control wire harness wire 2855 (red) at valve control wire harness passenger side tank-to-pump control valve connector, terminal 1 and a known good ground.

If 22 to 28 VDC are not present, repair wire 2855 in valve control wire harness if repairable (TM 9-2320-325-14&P), or replace valve control wire harness (WP 0463).

- Step 35. Put cab or pump operator's panel TANK TO PUMP switch to off position (WP 0004). Turn battery disconnect switch to OFF position (WP 0007). Check for continuity across valve control wire harness wire 2200 (black) from valve control wire harness passenger side tank-to-pump control valve connector, terminal 2 to a known good ground.
- a. If there is continuity, replace shutoff control valve manifold (WP 0427).
  - b. If there is no continuity, repair wire 2200 in valve control wire harness if repairable (TM 9-2320-325-14&P), or replace valve control wire harness (WP 0463).

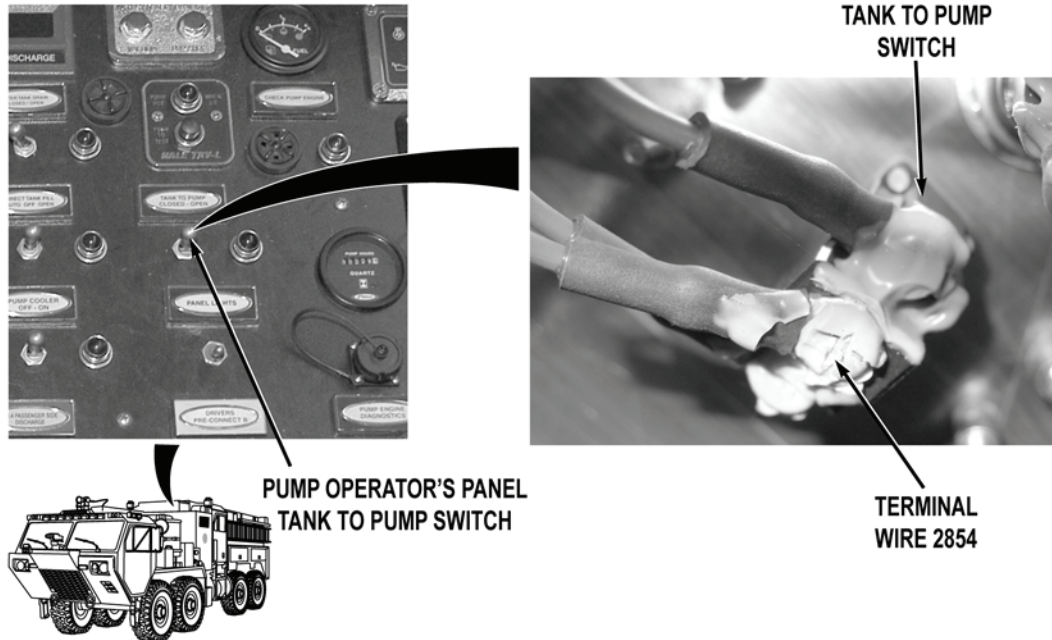
**MALFUNCTION****TEST OR INSPECTION****CORRECTIVE ACTION****WARNING**

**Remove rings, wristwatches, neck chains, and any other jewelry before working around vehicle. Jewelry can catch on equipment and cause serious injury. Jewelry and tools may short across electrical circuits and cause damage to equipment, or severe burns or electrical shock to personnel.**

- Step 36. Open pump operator's panel housing (WP 0325). Check for 22 to 28 VDC between pump operator's panel wire harness wire 2854 (red) at pump operator's panel TANK TO PUMP switch, terminal and a known good ground.

If 22 to 28 VDC are not present, go to Step 41.

- Step 37. Turn battery disconnect switch to OFF position (WP 0007). Check for continuity across pump operator's panel TANK TO PUMP switch, from terminal wire 2854 (red) to terminal wire 2855 (red), when switch is put to open position.

If there is no continuity, replace pump operator's panel TANK TO PUMP switch (WP 0338).

**MALFUNCTION**

**TEST OR INSPECTION**

**CORRECTIVE ACTION**

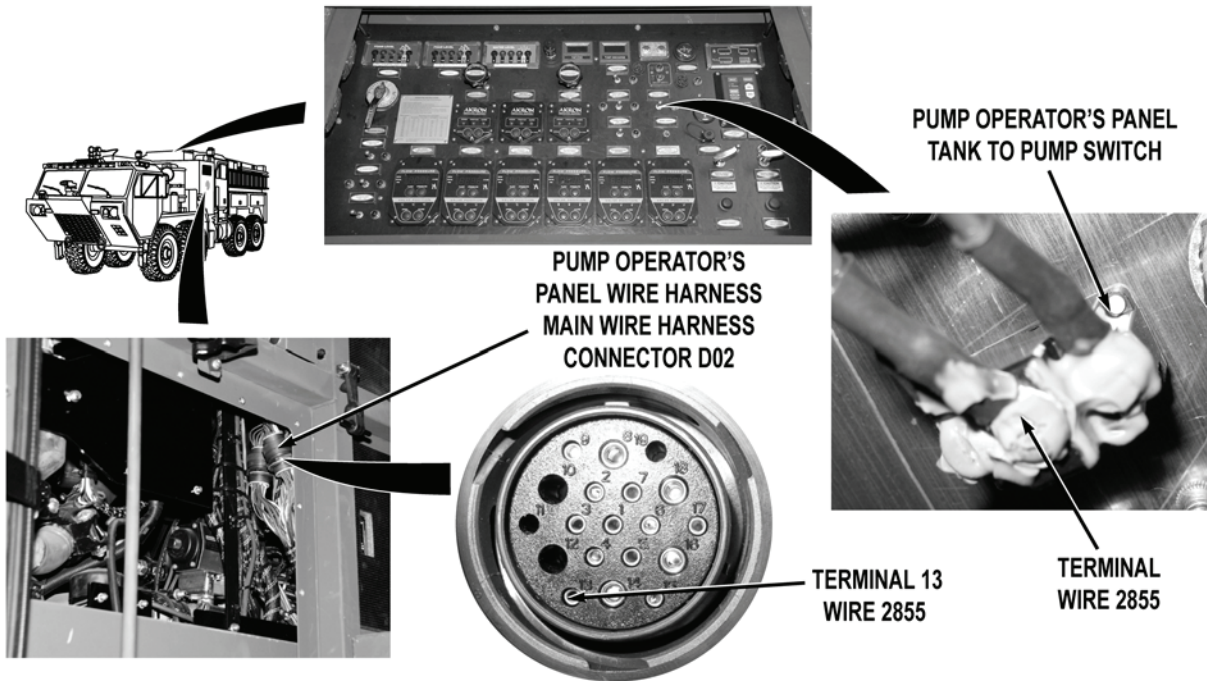

Step 38. Remove crew cab access panel (WP 0499). Remove pump house panel Q (WP 0540). Disconnect main wire harness pump operator's panel wire harness connector DO2. With a test lead set, check for continuity across main wire harness wire 2855 (red) from main wire harness pump operator's panel wire harness connector DO2, terminal 13 to pump operator's panel TANK TO PUMP switch.

If there is no continuity, repair wire 2855 in pump operator's panel wire harness if repairable (TM 9-2320-325-14&P), or replace pump operator's panel wire harness (WP 0459).



**MALFUNCTION****TEST OR INSPECTION****CORRECTIVE ACTION**

- Step 39. Disconnect main wire harness valve control wire harness connector DV1. With a test lead set, check for continuity across main wire harness wire 2855 (red) from main wire harness pump operator's panel wire harness connector DO2, terminal 13 to main wire harness valve control wire harness connector DV1, terminal 9.

If there is no continuity, repair wire 2855 in valve control wire harness if repairable (TM 9-2320-325-14&P), or replace main wire harness (WP 0455).

**MALFUNCTION**

**TEST OR INSPECTION**

**CORRECTIVE ACTION**

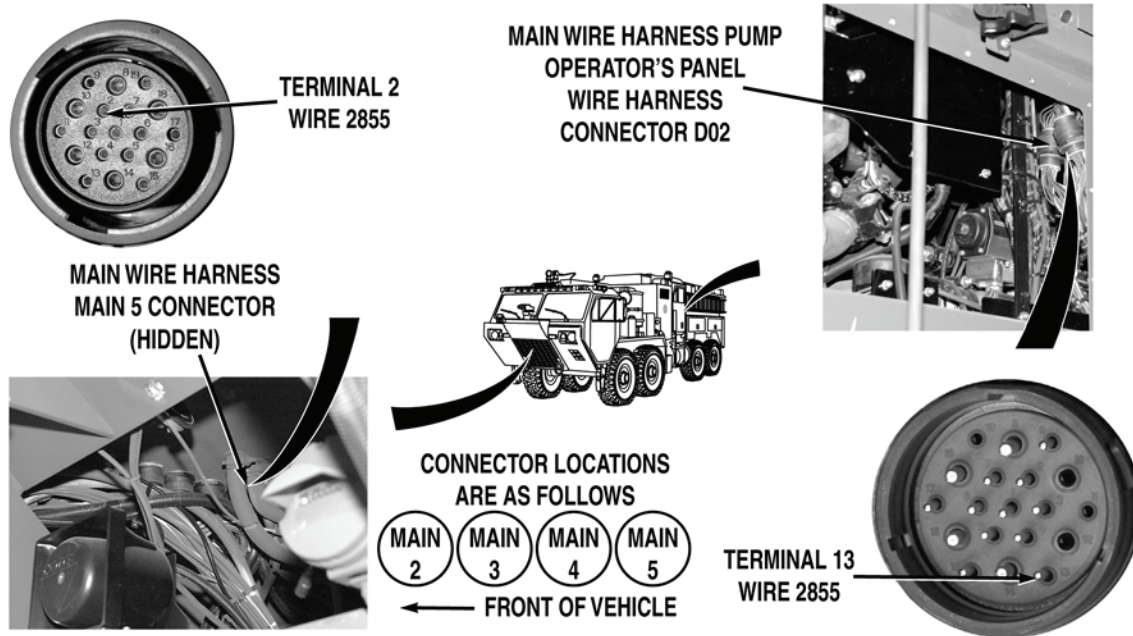

- Step 40. Remove skid plate grille (WP 0550). Disconnect main wire harness main 5 connector. With a test lead set, check for continuity across main wire harness wire 2855 (red) from main wire harness main 5 connector, terminal 2 to main wire harness pump operator's panel wire harness connector DO2, terminal 13.
- a. If there is continuity, repair wire 2855 in cab pump control wire harness if repairable (TM 9-2320-325-14&P), or replace cab pump control wire harness (WP 0443).
  - b. If there is no continuity, repair wire 2855 in main wire harness if repairable (TM 9-2320-325-14&P), or replace main wire harness (WP 0455).

**MALFUNCTION****TEST OR INSPECTION****CORRECTIVE ACTION****WARNING**

**Remove rings, wristwatches, neck chains, and any other jewelry before working around vehicle. Jewelry can catch on equipment and cause serious injury. Jewelry and tools may short across electrical circuits and cause damage to equipment, or severe burns or electrical shock to personnel.**

- Step 41. Remove crew cab access panel (WP 0499). Remove pump house panel Q (WP 0540). Disconnect main wire harness pump operator's panel wire harness connector DO2. With a test lead set, check for 22 to 28 VDC between main wire harness wire 2854 (red) at main wire harness pump operator's panel wire harness connector DO2, terminal 17 and a known good ground.

If 22 to 28 VDC are present, repair wire 2854 in pump operator's panel wire harness if repairable (TM 9-2320-325-14&P), or replace pump operator's panel wire harness (WP 0459).

**MALFUNCTION**

**TEST OR INSPECTION**

**CORRECTIVE ACTION**

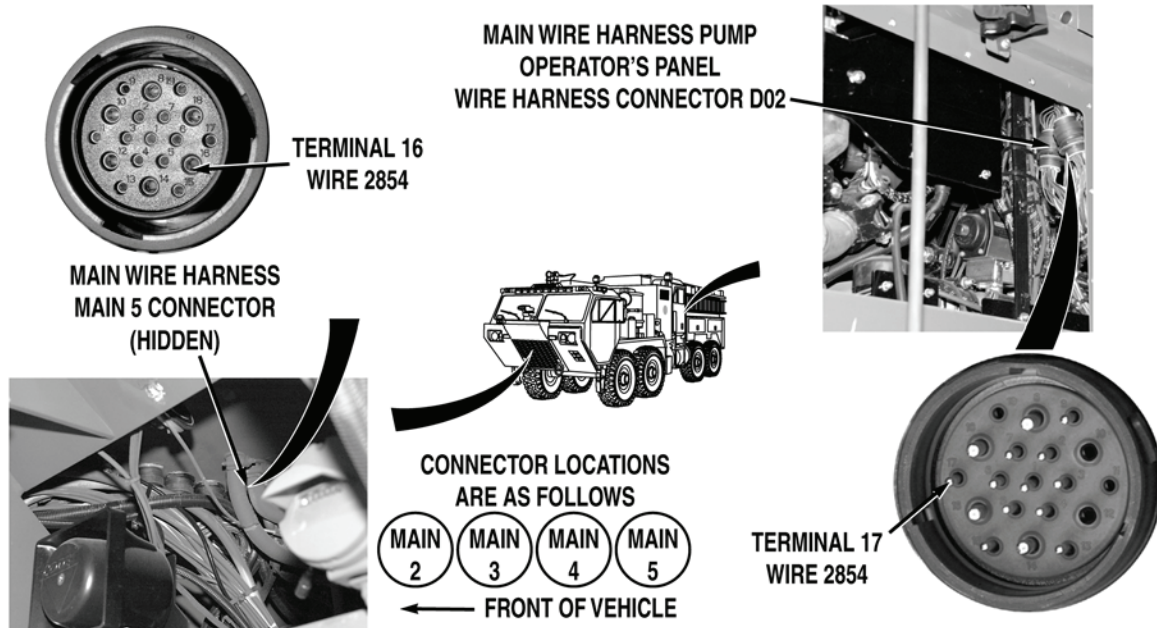

- Step 42. Turn battery disconnect switch to OFF position (WP 0007). Remove skid plate grille (WP 0550). Disconnect main wire harness main 5 connector. With a test lead set, check for continuity across main wire harness wire 2854 (red) from main wire harness main 5 wire harness connector, terminal 16 to main wire harness pump operator's panel wire harness connector DO2, terminal 17.
- a. If there is continuity, repair wire 2854 in cab pump control wire harness if repairable (TM 9-2320-325-14&P, or replace cab pump control wire harness (WP 0443).
  - b. If there is no continuity, repair wire 2854 in main wire harness if repairable (TM 9-2320-325-14&P), or replace main wire harness (WP 0455).

**MALFUNCTION**  
**TEST OR INSPECTION**  
**CORRECTIVE ACTION**

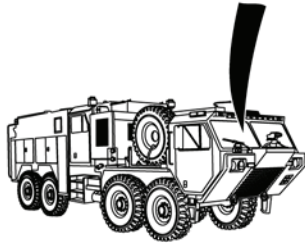
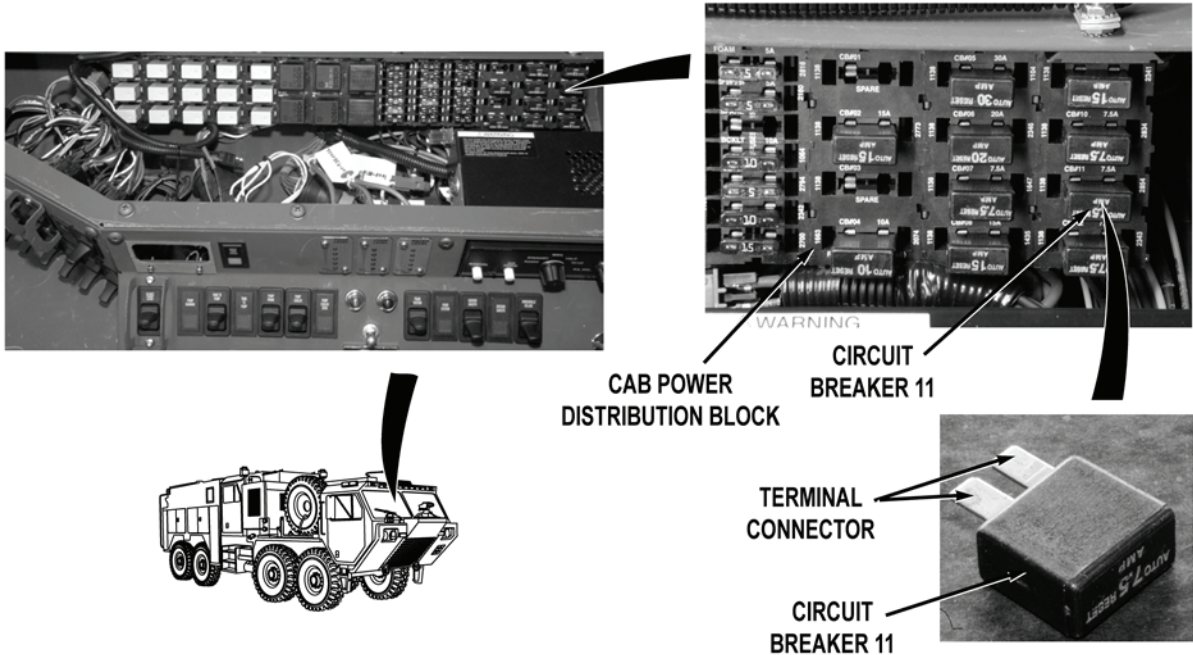

**WARNING**



Remove rings, wristwatches, neck chains, and any other jewelry before working around vehicle. Jewelry can catch on equipment and cause serious injury. Jewelry and tools may short across electrical circuits and cause damage to equipment, or severe burns or electrical shock to personnel.

Step 43. Turn battery disconnect switch to OFF position (WP 0007). Remove cab instrument panel A (WP 0311). Remove circuit breaker 11 from cab power distribution block (WP 0398). Check for continuity across circuit breaker 11 terminal connectors.

If there is no continuity, replace circuit breaker 11 (WP 0398).

**MALFUNCTION**

**TEST OR INSPECTION**

**CORRECTIVE ACTION**

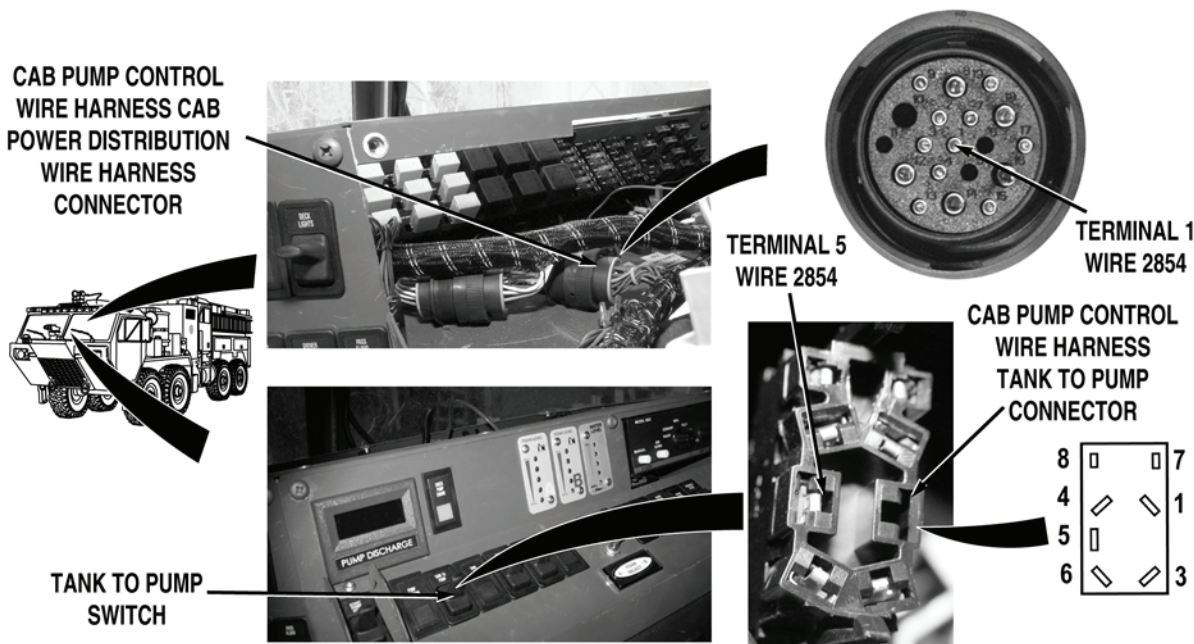

- Step 44. Install circuit breaker 11 (WP 0398). Disconnect cab pump control wire harness cab power distribution wire harness connector. With a test lead set, check for continuity across cab pump control wire harness wire 2854 (red) from cab TANK TO PUMP switch connector, terminal 5 to cab pump control wire harness connector, terminal 1.
- a. If there is continuity, repair wire 2854 in cab power distribution wire harness if repairable (TM 9-2320-325-14&P), or replace cab power distribution wire harness and block (WP 0441).
  - b. If there is no continuity, repair wire 2854 in cab pump control wire harness if repairable (TM 9-2320-325-14&P), or replace cab pump control wire harness (WP 0443).

**END OF TASK**

**FOLLOW-ON MAINTENANCE**

1. Install shield if removed (WP 0493)
2. Remove wheel chocks (TM 9-2320-347-10)

**END OF TASK**

**END OF WORK PACKAGE**

**FIELD LEVEL MAINTENANCE**

**GROUND SWEEPS DO NOT OPERATE WHEN SELECTED**

**INITIAL SETUP:**

**Tools and Special Tools**

- Lead Set, Test (WP 0622, Item 21)
- Tool Kit, General Mechanic's: Automotive (WP 0622, Item 27)

**Personnel Required**

- MOS 63B Wheeled vehicle mechanic (2)

**References**

- TM 9-2320-325-14&P
- WP 0004
- WP 0007
- WP 0026
- WP 0311
- WP 0315
- WP 0375

**References (continued)**

- WP 0398
- WP 0441
- WP 0443
- WP 0455
- WP 0463
- WP 0499
- WP 0539
- WP 0540
- WP 0550
- WP 0567
- WP 0575
- WP 0576

**Equipment Conditions**

- Water pump engine OFF (WP 0022)
- Engine OFF (TM 9-2320-347-10)
- Wheels chocked (TM 9-2320-347-10)

**MALFUNCTION**

**TEST OR INSPECTION**

**CORRECTIVE ACTION**

**GROUND SWEEPS DO NOT OPERATE WHEN SELECTED**

---

**MALFUNCTION****TEST OR INSPECTION****CORRECTIVE ACTION**

---

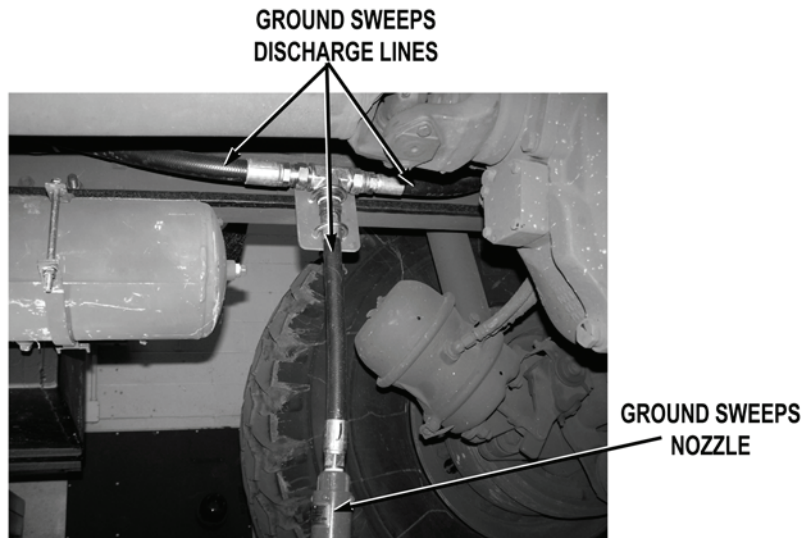

Step 1. Check ground sweeps nozzles and discharge lines for kinks and damage.

If ground sweeps nozzles or discharge lines are kinked or damaged, replace damaged ground sweeps nozzles and discharge lines (WP 0575).

Step 2. Turn battery disconnect switch to ON position (WP 0007). Set up system to pump from onboard water tank (WP 0026). Put cab GROUND SWEEPS switch to on position (WP 0004). Check if water is delivered to all ground sweeps nozzles.

If water is delivered to at least one ground sweeps nozzle, go to Step 16.



**MALFUNCTION**  
**TEST OR INSPECTION**  
**CORRECTIVE ACTION**

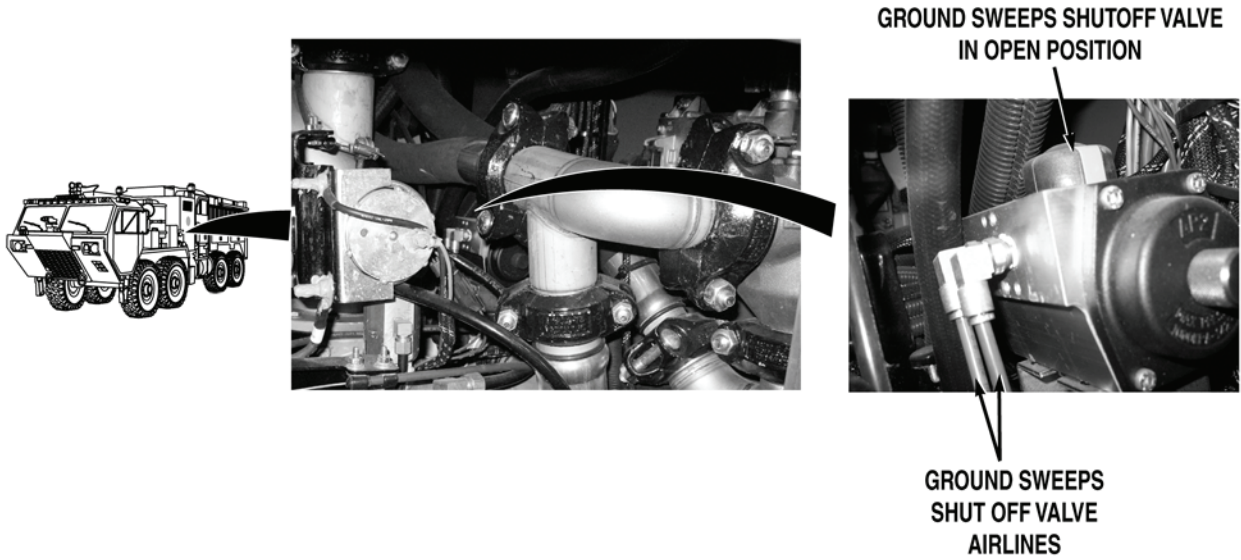

Step 3. Open pump house panel A (WP 0539). Inspect air lines from air control valve manifold to ground sweeps nozzle valve for kinks and damage.

If air lines are kinked or damaged, replace damaged air lines (WP 0567).

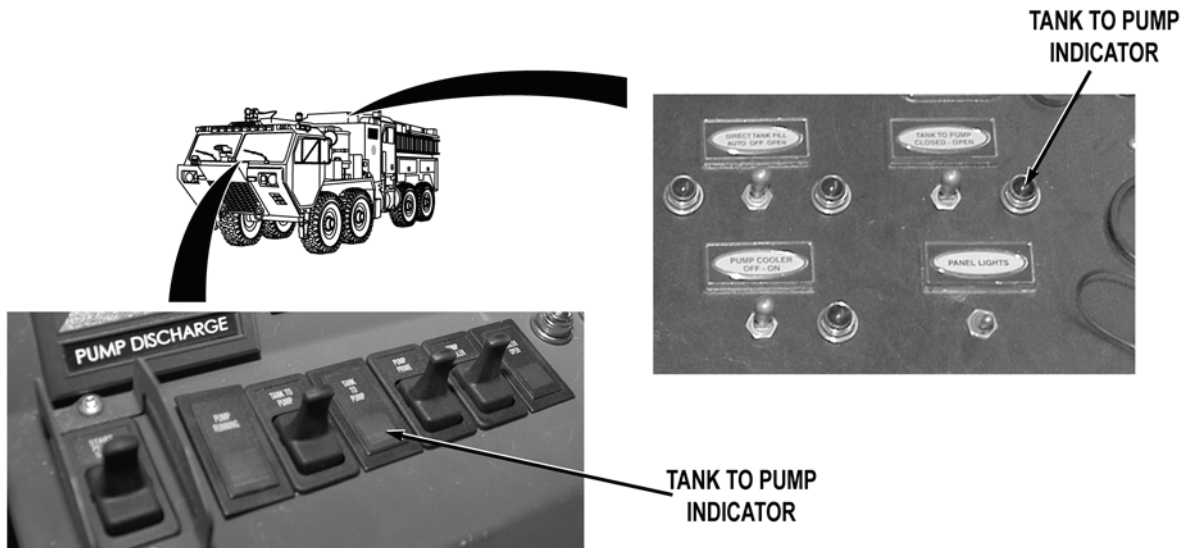

Step 4. Turn battery disconnect switch to ON position (WP 0007). Put cab or pump operator's panel TANK TO PUMP switch to OPEN position (WP 0004). Check if TANK TO PUMP indicator illuminates.

If TANK TO PUMP indicator does not illuminate, go to Step 14.

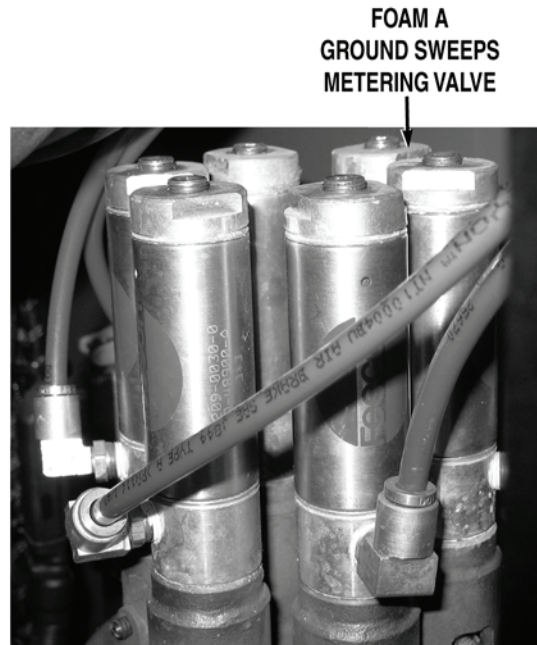
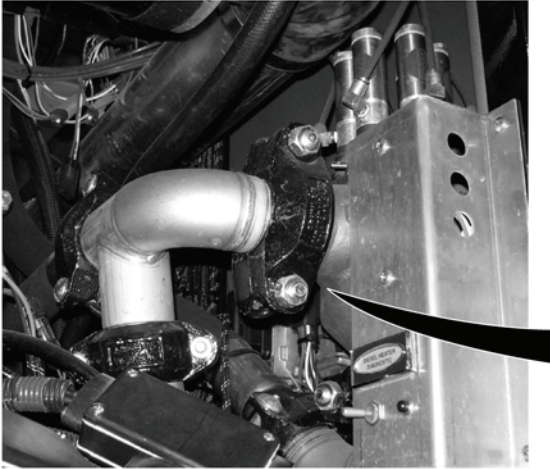
**MALFUNCTION****TEST OR INSPECTION****CORRECTIVE ACTION****NOTE**

- Ensure system air pressure is at least 85 psi (586 kPa) during this procedure. System air pressure is required to activate valves.
- Do not engage water pump engine during this procedure, except when performing complete system checks. Valve operations can be checked without water pump operation.
- Valve operations can be checked by observing valve shaft rotation. Valves are open when tabs or yellow paint tabs are aligned with direction of fluid flow.
- Operation of multi-metering valve cylinder can be checked by listening for a metallic click.

Step 5. Put TANK TO PUMP switch to closed position (WP 0004). If system air pressure is below 85 psi (586 kPa), start vehicle engine and allow system air pressure to build to at least 85 psi (586 kPa) (TM 9-2320-347-10). Shut off vehicle engine (TM 9-2320-347-10). Open pump house panel A (WP 0539). Put cab FOAM SYSTEM switch to on position (WP 0004). Put cab FOAM SELECT switch to A position (WP 0004). While an assistant puts GROUND SWEEPS switch to on position (WP 0004), check if ground sweeps foam A multi-metering cylinder valve operates to open position.

If ground sweeps foam A multi-metering cylinder valve does not operate to open position, go to Step 9.

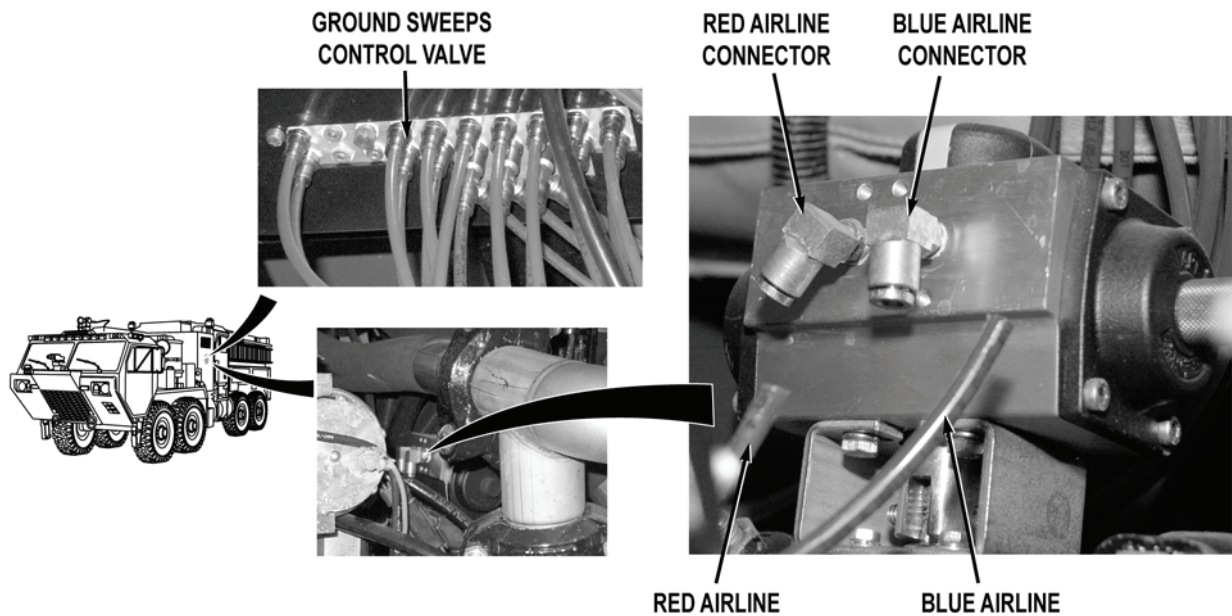
**MALFUNCTION****TEST OR INSPECTION****CORRECTIVE ACTION****WARNING**

- If air lines are under pressure when they are disconnected, they can whip around and cause injury to personnel. Caution should be exercised when disconnecting air line fittings.
- Air lines may be under pressure when control valve is operated. If under pressure and air lines are disconnected, air lines may whip around and cause injury to personnel. Caution should be exercised when operating control valve with air lines disconnected.

**NOTE**

Air pressure is checked by disconnecting air lines at ground sweeps valve and observing air pressure escaping from air lines, when ground sweeps control valve is activated. Air will escape from blue air line when GROUND SWEEPS switch is put to on position, and escape from red air line when GROUND SWEEPS switch is put to off position. System air pressure may drop below 85 psi (586 kPa) during this procedure.

- Step 6. Put GROUND SWEEPS switch to off position (WP 0004). Put FOAM SYSTEM switch to off position (WP 0004). Disconnect air lines at ground sweeps nozzles valve. While an assistant puts GROUND SWEEPS switch to on position (WP 0004), check if air pressure is present at ground sweeps valve.

If air pressure is present, replace ground sweeps valve (WP 0576).

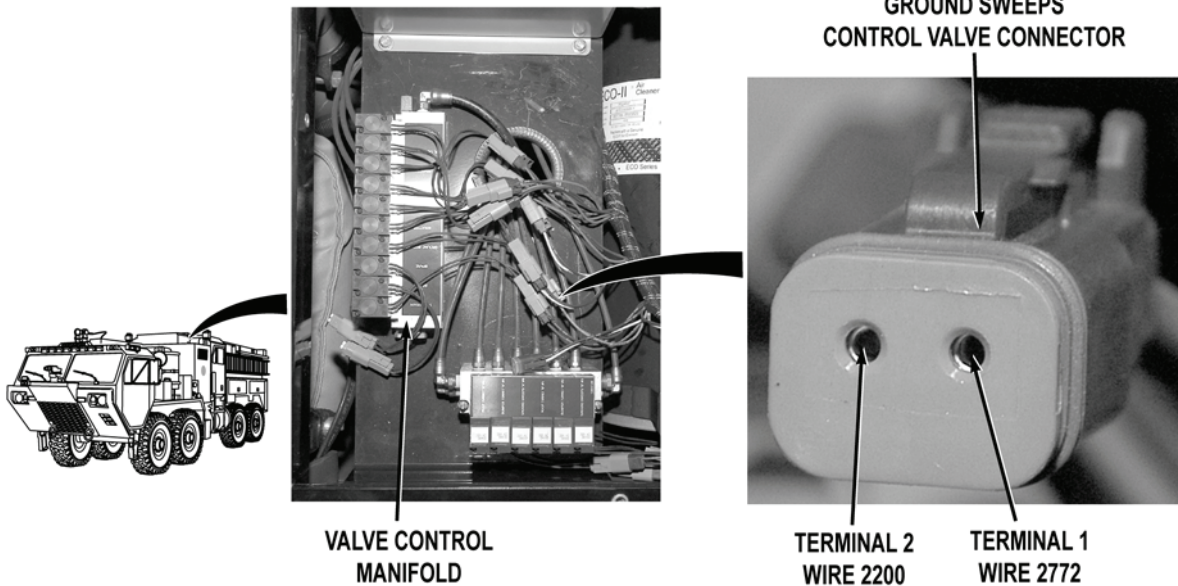
**MALFUNCTION****TEST OR INSPECTION****CORRECTIVE ACTION****WARNING**

**Remove rings, wristwatches, neck chains, and any other jewelry before working around vehicle. Jewelry can catch on equipment and cause serious injury. Jewelry and tools may short across electrical circuits and cause damage to equipment, or severe burns or electrical shock to personnel.**

- Step 7. Connect air lines at ground sweeps nozzles valve. Turn battery disconnect switch to OFF position (WP 0007). Disconnect valve control wire harness ground sweeps control valve connector. Turn battery disconnect switch to ON position. Put GROUND SWEEPS switch to on position (WP 0004). With a test lead set, check for 22 to 28 VDC between valve control wire harness wire 2772 (gray) at valve control wire harness ground sweeps control valve connector, terminal 1 and a known good ground.

If 22 to 28 VDC are not present, go to Step 10.

**MALFUNCTION****TEST OR INSPECTION****CORRECTIVE ACTION**

- Step 8. Put GROUND SWEEPS switch to off position (WP 0004). Turn battery disconnect switch to OFF position (WP 0007). With a test lead set, check for continuity across wire 2200 (black) from valve control wire harness ground sweeps control valve connector, terminal 2 to a known good ground.
- If there is continuity, replace ground sweeps control valve (WP 0375).
  - If there is no continuity, repair wire 2200 in valve control wire harness if repairable (TM 9-2320-325-14&P), or replace valve control wire harness (WP 0463).

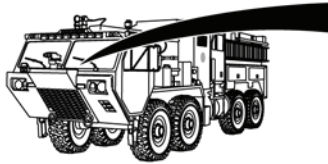

**GROUND SWEEPS  
INDICATOR**

- Step 9. Check if GROUND SWEEPS indicator is illuminated (WP 0004).
- If GROUND SWEEPS indicator is not illuminated, go to Step 12.

**MALFUNCTION****TEST OR INSPECTION****CORRECTIVE ACTION**

MAIN WIRE HARNESS  
PUMP OPERATOR'S PANEL  
WIRE HARNESS  
CONNECTOR DV1 (HIDDEN)

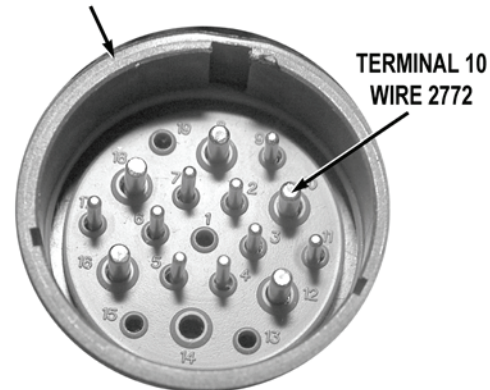
**WARNING**

**Remove rings, wristwatches, neck chains, and any other jewelry before working around vehicle. Jewelry can catch on equipment and cause serious injury. Jewelry and tools may short across electrical circuits and cause damage to equipment, or severe burns or electrical shock to personnel.**

- Step 10. Turn battery disconnect switch to OFF position (WP 0007). Remove driver side crew cab panel (WP 0499). Remove pump house panel Q (WP 0540). Turn battery disconnect switch to ON position. Put GROUND SWEEPS switch to on position (WP 0004). Disconnect main wire harness valve control wire harness connector DV1. With a test lead set, check for 22 to 28 VDC between main wire harness wire 2772 (gray) at main wire harness valve control wire harness connector DV1, terminal 10 and a known good ground.

If 22 to 28 VDC are present, repair wire 2772 in valve control wire harness if repairable (TM 9-2320-325-14&P), or replace valve control wire harness (WP 0463).

## MALFUNCTION

## TEST OR INSPECTION

## CORRECTIVE ACTION

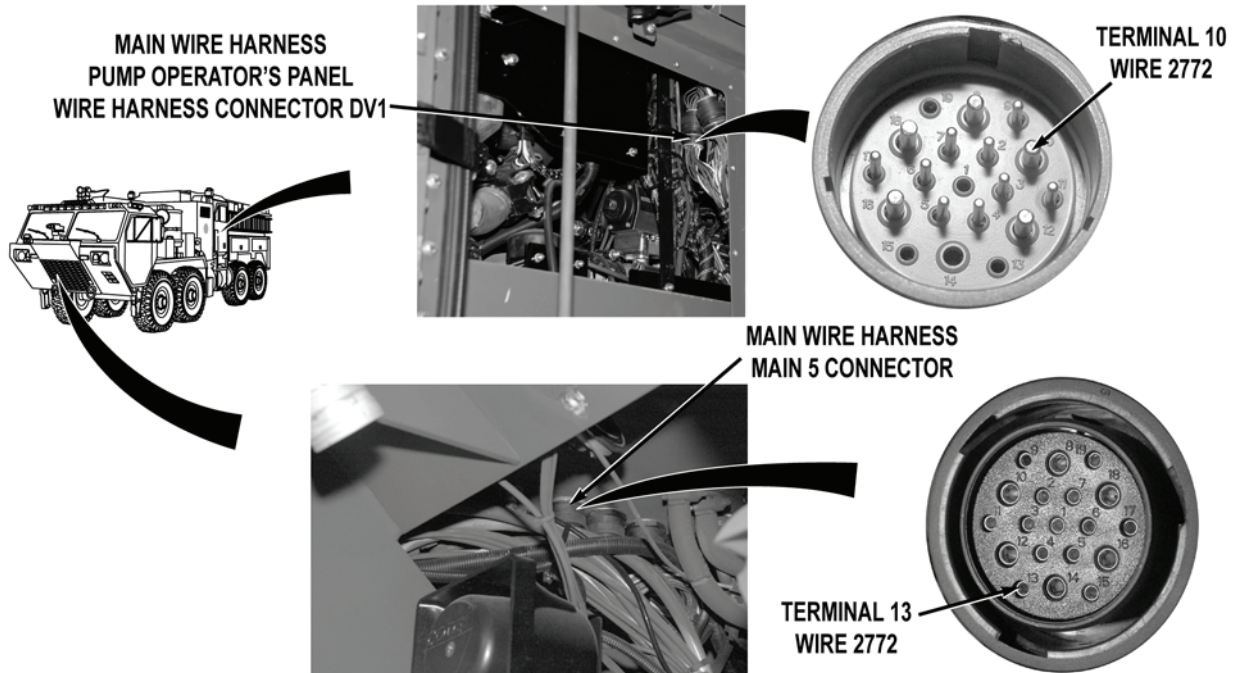

- Step 11. Put GROUND SWEEPS switch to off position (WP 0004). Turn battery disconnect switch to OFF position (WP 0007). Remove skid plate grille (WP 0550). Disconnect main wire harness main 5 connector. With a test lead set, check for continuity across main wire harness wire 2772 (gray) from main 5 connector, terminal 13 to main wire harness valve control wire harness connector DV1, terminal 10.
- a. If there is continuity, repair wire 2772 in cab pump control wire harness if repairable (TM 9-2320-325-14&P), or replace cab pump control wire harness (WP 0443).
  - b. If there is no continuity, repair wire 2772 in main wire harness if repairable (TM 9-2320-325-14&P), or replace main wire harness (WP 0455).

## MALFUNCTION

## TEST OR INSPECTION

## CORRECTIVE ACTION

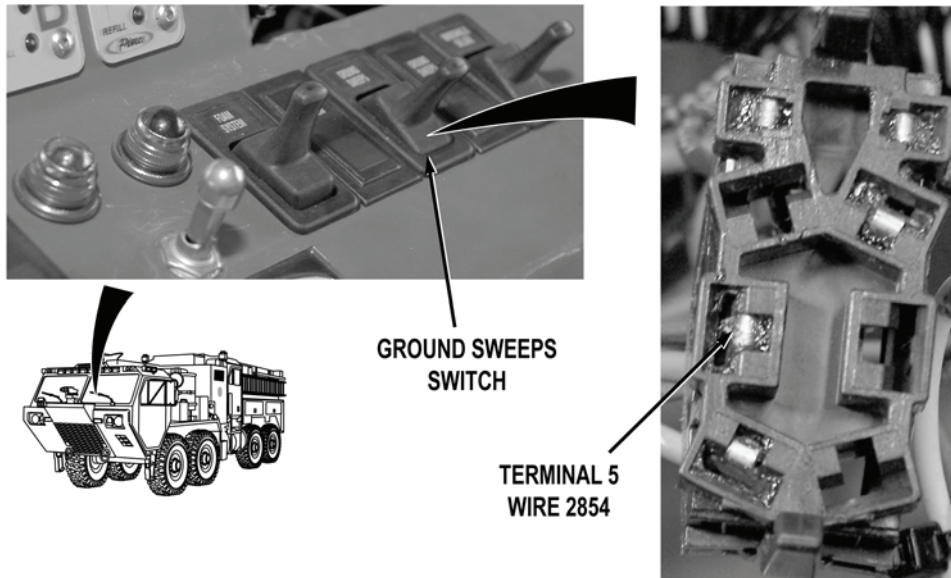
**WARNING**

**Remove rings, wristwatches, neck chains, and any other jewelry before working around vehicle. Jewelry can catch on equipment and cause serious injury. Jewelry and tools may short across electrical circuits and cause damage to equipment, or severe burns or electrical shock to personnel.**

- Step 12. Put GROUND SWEEPS switch to off position (WP 0004). Remove cab instrument panel B (WP 0311). Turn battery disconnect switch to OFF position (WP 0007). Disconnect cab pump control wire harness GROUND SWEEPS switch connector. Put battery disconnect switch to ON position (WP 0007). Check for 22 to 28 VDC between cab pump control wire harness wire 2854 (red) at GROUND SWEEPS switch connector, terminal 5 and a known good ground.

If 22 to 28 VDC are not present, repair wire 2854 in cab pump control wire harness if repairable (TM 9-2320-325-14&P), or replace cab pump control wire harness (WP 0443).



---

**MALFUNCTION****TEST OR INSPECTION****CORRECTIVE ACTION**

---

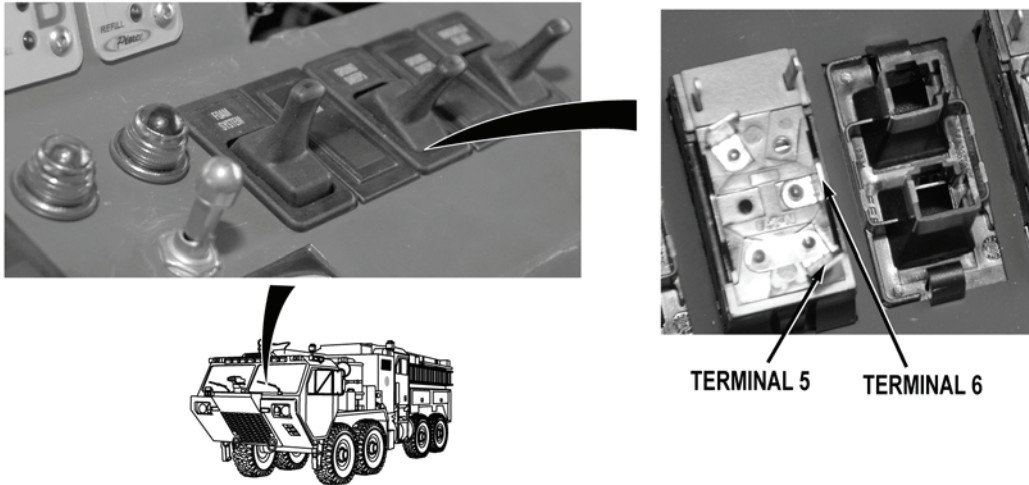

- Step 13. Turn battery disconnect switch to OFF position (WP 0007). Check for continuity across GROUND SWEEPS switch, from terminal 5 to terminal 6, when switch is in on position.
- a. If there is continuity, repair wire 2772 in cab pump control wire harness if repairable (TM 9-2320-325-14&P), or replace cab pump control wire harness (WP 0443).
  - b. If there is no continuity, replace GROUND SWEEPS switch (WP 0315).

## MALFUNCTION

## TEST OR INSPECTION

## CORRECTIVE ACTION

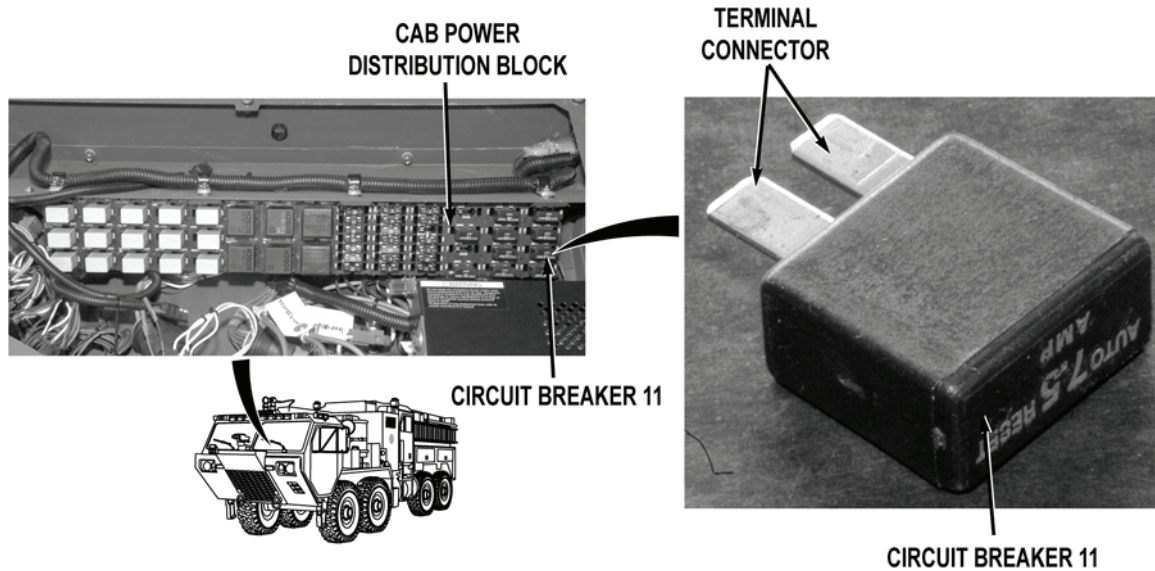
**WARNING**

**Remove rings, wristwatches, neck chains, and any other jewelry before working around vehicle. Jewelry can catch on equipment and cause serious injury. Jewelry and tools may short across electrical circuits and cause damage to equipment, or severe burns or electrical shock to personnel.**

- Step 14. Turn battery disconnect switch to OFF position (WP 0007). Remove cab instrument panel A (WP 0311). Remove circuit breaker 11 from cab power distribution block (WP 0398). Check for continuity across circuit breaker.

If there is no continuity, replace circuit breaker 11 (WP 0398).

## MALFUNCTION

## TEST OR INSPECTION

## CORRECTIVE ACTION

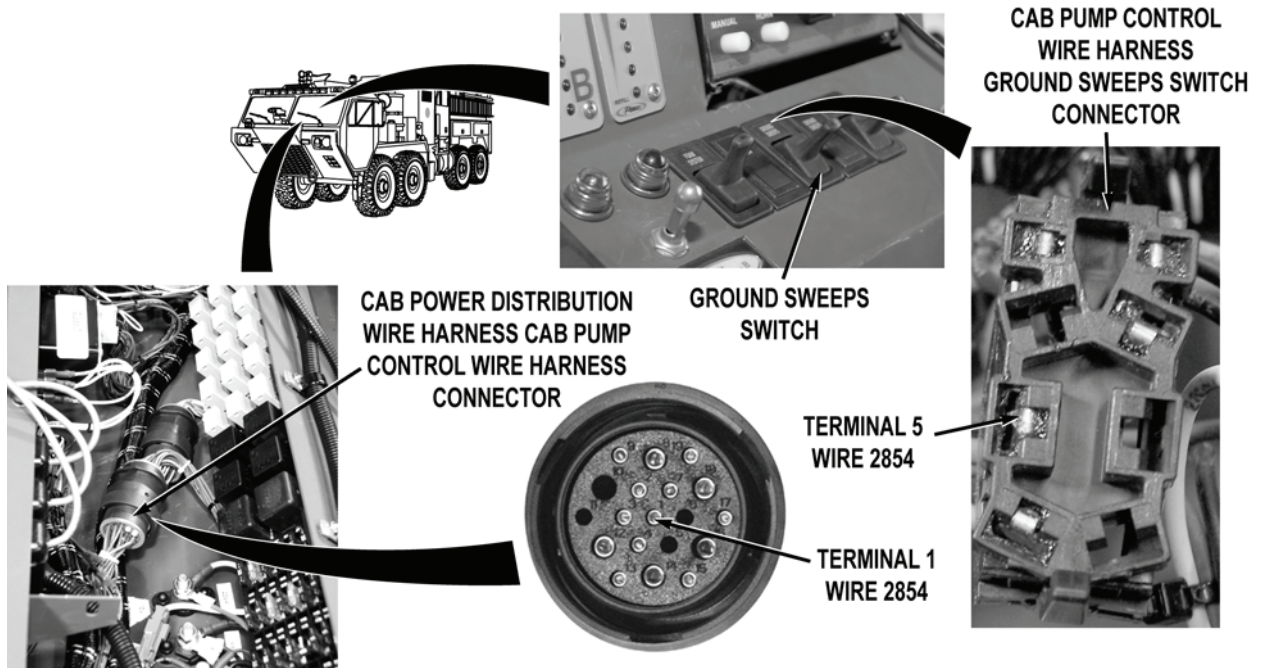

- Step 15. Install circuit breaker 11 (WP 0398). Disconnect cab power distribution wire harness cab pump control wire harness connector. With a test lead set, check for continuity across cab pump control wire harness wire 2854 (red) from cab pump control wire harness GROUND SWEEPS switch connector, terminal 5 to cab pump control wire harness connector, terminal 1.
- a. If there is continuity, repair wire 2854 in cab power distribution wire harness if repairable (TM 9-2320-325-14&P), or replace cab power distribution wire harness and block (WP 0441).
  - b. If there is no continuity, repair wire 2854 in cab pump control wire harness if repairable (TM 9-2320-325-14&P), or replace cab pump control wire harness (WP 0443).

---

**MALFUNCTION****TEST OR INSPECTION****CORRECTIVE ACTION**

---

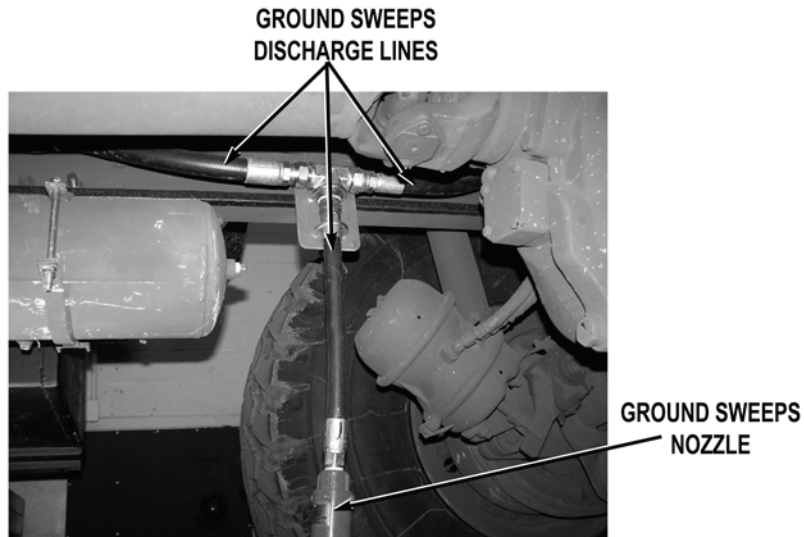

- Step 16. Remove non-operating ground sweeps (WP 0575). Check ground sweeps for contamination and debris.
- a. If ground sweeps nozzle is contaminated, clean debris or replace ground sweeps nozzle (WP 0575).
  - b. If ground sweeps is free from contamination, replace plugged discharge line (WP 0575).

**END OF TASK****FOLLOW-ON MAINTENANCE**

Remove wheel chocks (TM 9-2320-347-10)

**END OF TASK****END OF WORK PACKAGE**

**FIELD LEVEL MAINTENANCE**

**HYDRAULIC GENERATOR PTO DOES NOT ENGAGE WHEN SELECTED**

**INITIAL SETUP:**

**Tools and Special Tools**

Lead Set, Test (WP 0622, Item 21)  
 Tool Kit, General Mechanic's: Automotive  
 (WP 0622, Item 27)

**Personnel Required**

MOS 63B Wheeled vehicle mechanic (2)

**References**

TM 9-2320-325-14&P  
 WP 0004  
 WP 0007  
 WP 0021  
 WP 0139  
 WP 0311

**References (continued)**

WP 0315  
 WP 0401  
 WP 0440  
 WP 0441  
 WP 0455  
 WP 0550  
 WP 0586  
 WP 0600  
 WP 0601  
 WP 0602

**Equipment Conditions**

Water pump engine OFF (WP 0022)  
 Engine OFF (TM 9-2320-347-10)  
 Wheels chocked (TM 9-2320-347-10)

**MALFUNCTION**

**TEST OR INSPECTION**

**CORRECTIVE ACTION**

**HYDRAULIC GENERATOR PTO DOES NOT ENGAGE WHEN SELECTED**

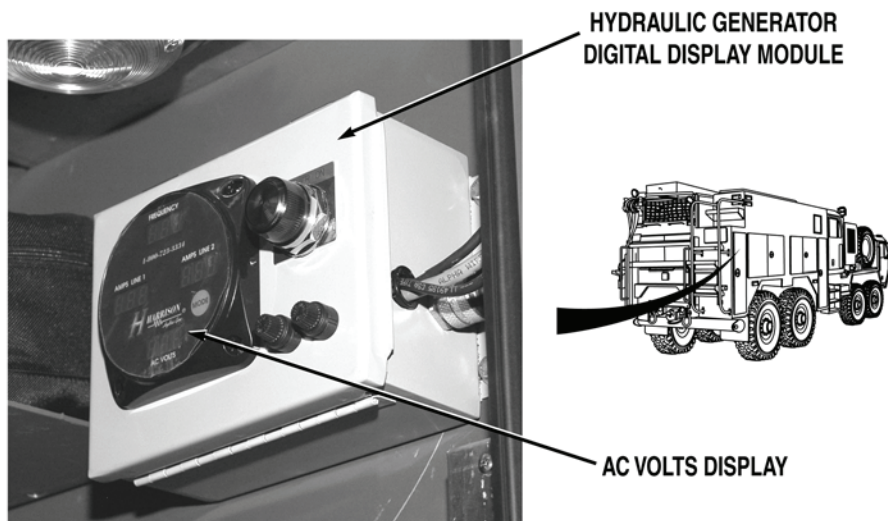
**MALFUNCTION****TEST OR INSPECTION****CORRECTIVE ACTION**

- Step 1. Turn battery disconnect switch to ON position (WP 0007). Start vehicle engine (TM 9-2320-347-10). While an assistant puts cab GENERATOR PTO switch to on position (WP 0004), check if 200 to 240 VAC are displayed on hydraulic generator digital display module AC volts display.

If 200 to 240 VAC are displayed and GEN PTO indicator is not illuminated, troubleshoot GEN PTO ENGAGE Indicator Does Not Illuminate (Cab) (WP 0139).

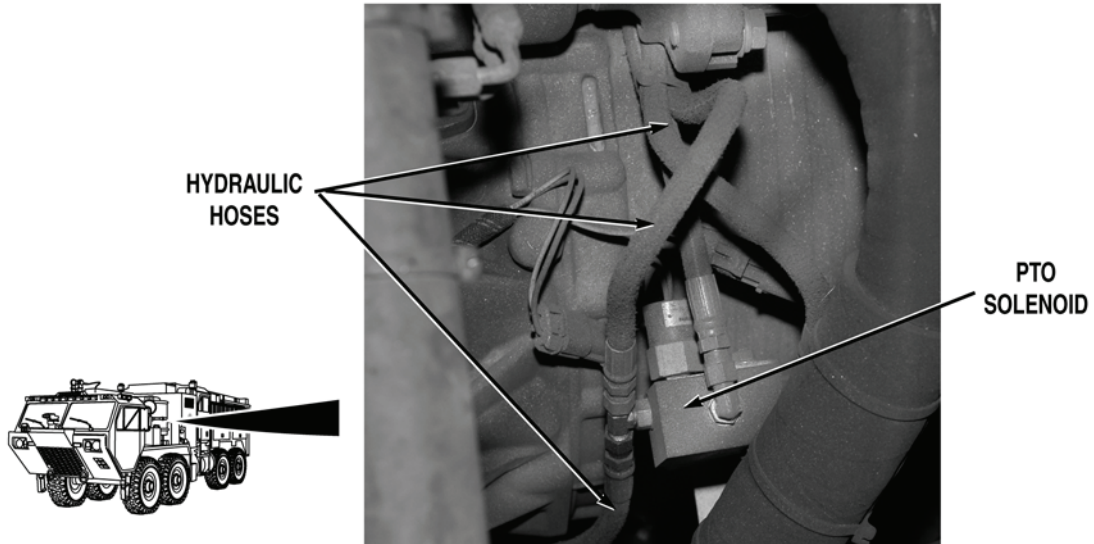
**MALFUNCTION****TEST OR INSPECTION****CORRECTIVE ACTION**

- Step 2. Put cab GENERATOR PTO switch to off position (WP 0004). Turn vehicle engine OFF (TM 9-2320-347-10). Check if PTO solenoid hydraulic hoses are free from kinks, leaks, and damage.

If hoses are kinked, leak or are damaged, replace damaged hose(s) (WP 0586).

- Step 3. Turn battery disconnect switch to ON position (WP 0007). While an assistant puts cab GENERATOR PTO switch to on and off positions (WP 0021), check if PTO solenoid operates.

If PTO solenoid does not operate, go to Step 5.

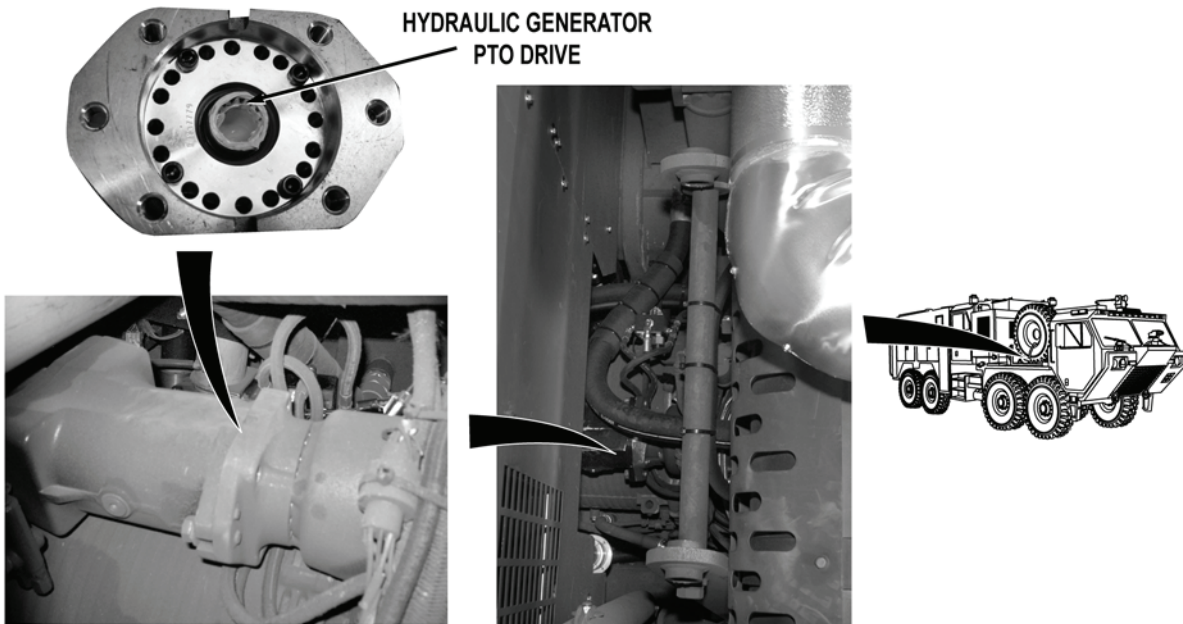
**MALFUNCTION****TEST OR INSPECTION****CORRECTIVE ACTION****WARNING**

**PTO solenoid operation is checked by listening to audible click and feeling for vibrations at PTO solenoid when PTO switch is put to on position (WP 0004). Do not start engine during this procedure. Failure to comply may result in serious injury or death to personnel.**

- Step 4. Turn battery disconnect switch to OFF position (WP 0007). Remove PTO pump (WP 0601). Turn battery disconnect switch to ON position (WP 0007). Start vehicle engine (TM 9-2320-347-10). While an assistant puts GENERATOR PTO switch to on position (WP 0004), check if hydraulic generator PTO drive rotates.
- a. If hydraulic generator PTO drive rotates, replace PTO pump (WP 0601).
  - b. If hydraulic generator PTO drive does not rotate, replace PTO (WP 0600).

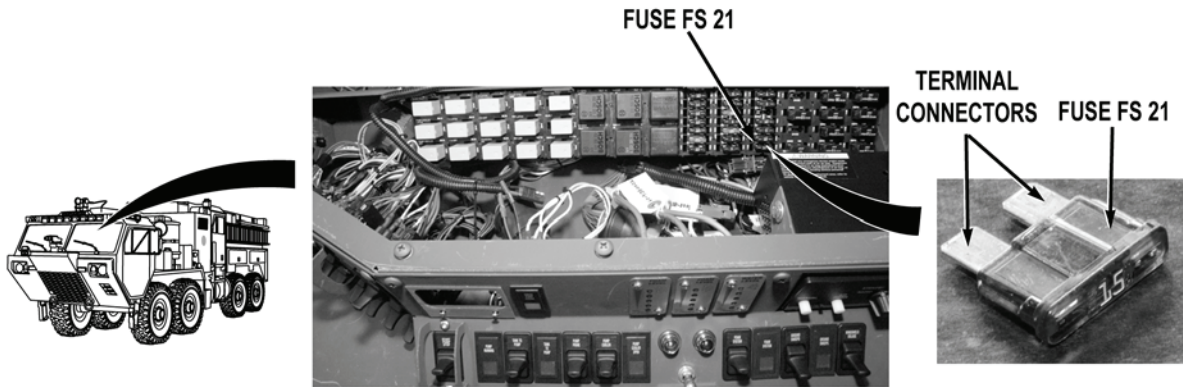

**MALFUNCTION****TEST OR INSPECTION****CORRECTIVE ACTION****WARNING**

**Remove rings, wristwatches, neck chains, and any other jewelry before working around vehicle. Jewelry can catch on equipment and cause serious injury. Jewelry and tools may short across electrical circuits and cause damage to equipment, or severe burns or electrical shock to personnel.**

- Step 5. Turn battery disconnect switch to OFF position (WP 0007). Remove cab instrument panel A (WP 0311). Remove fuse FS 21 (WP 0401). Check for continuity across terminal connectors of fuse FS 21.

If there is no continuity, replace fuse FS 21 (WP 0401).

**MALFUNCTION**

**TEST OR INSPECTION**

**CORRECTIVE ACTION**

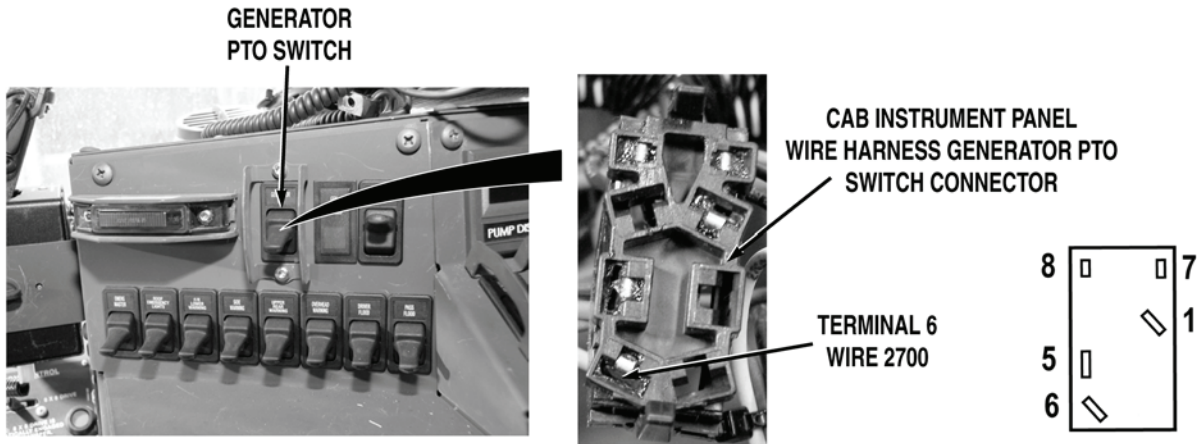

Step 6. Install fuse FS 21 (WP 0401). Remove cab instrument panel C (WP 0311). Disconnect cab instrument panel wire harness GENERATOR PTO switch connector. Turn battery disconnect switch to ON position (WP 0007). Check for 22 to 28 VDC between cab instrument panel wire harness wire 2700 (red) at GENERATOR PTO switch connector, terminal 6 and a known good ground.

If 22 to 28 VDC are not present, go to Step 11.

**MALFUNCTION**

**TEST OR INSPECTION**

**CORRECTIVE ACTION**

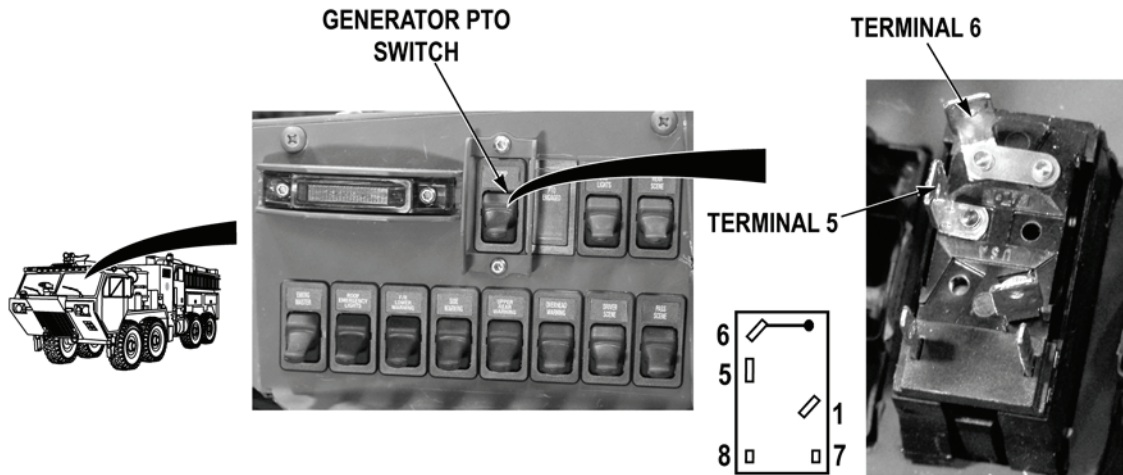

Step 7. Turn battery disconnect switch to OFF position (WP 0007). While an assistant puts GENERATOR PTO switch to on position (WP 0004), check for continuity across GENERATOR PTO switch, from terminal 5 to terminal 6, when switch is put to on position.

If there is no continuity, replace GENERATOR PTO switch (WP 0315).

**MALFUNCTION**

**TEST OR INSPECTION**

**CORRECTIVE ACTION**

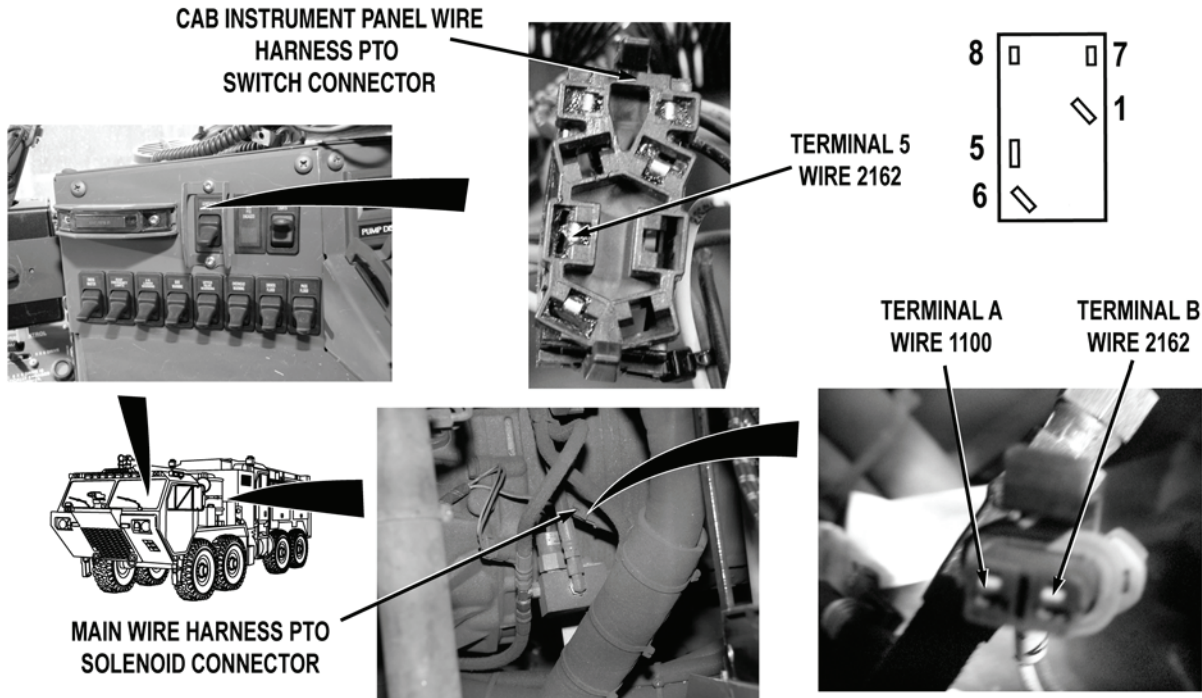

**WARNING**



**Do not start engine during this procedure. Failure to comply may result in serious injury or death to personnel.**

Step 8. Disconnect main wire harness PTO solenoid connector. With a test lead set, check for continuity across wire 2162 (white) from cab instrument panel wire harness PTO switch connector, terminal 5 to main wire harness PTO solenoid connector, terminal B.

If there is no continuity, go to Step 10.

Step 9. Check for continuity across wire 1100 (black) from main wire harness PTO solenoid connector, terminal A to a known good ground.

- a. If there is continuity, replace generator PTO solenoid (WP 0602).
- b. If there is no continuity, repair wire 1100 in main wire harness if repairable (TM 9-2320-325-14&P), or replace main wire harness (WP 0455).

**MALFUNCTION**

**TEST OR INSPECTION**

**CORRECTIVE ACTION**

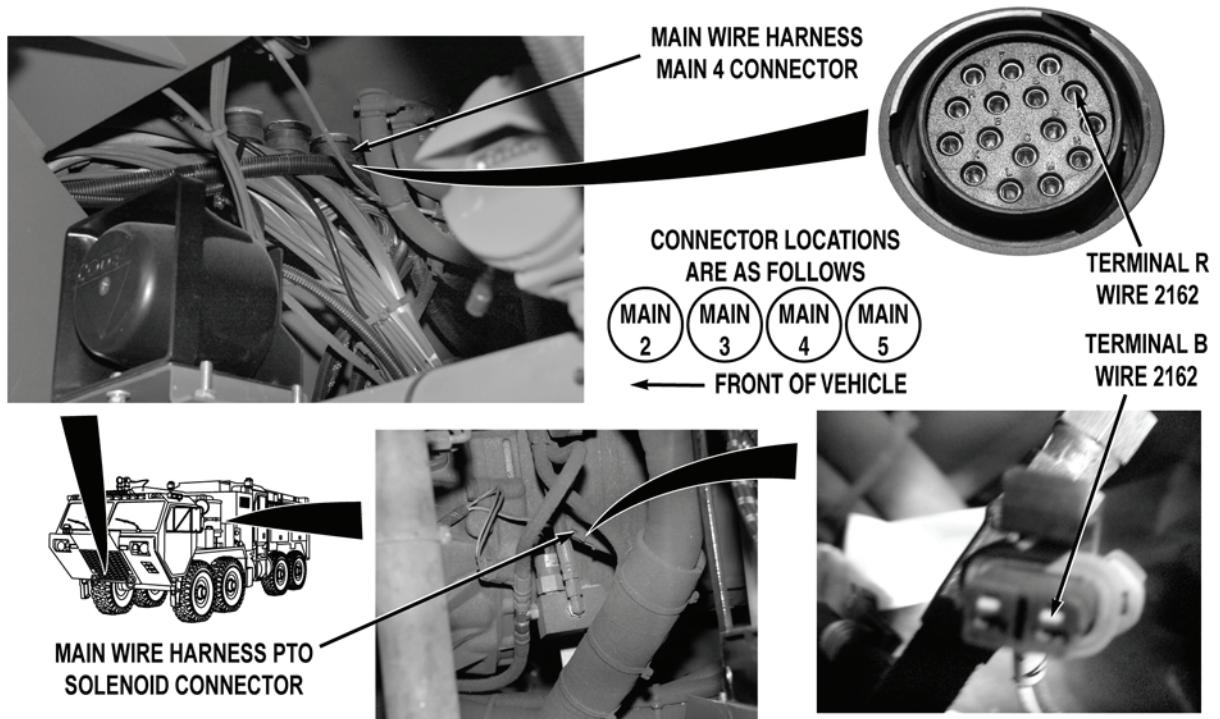

- Step 10. Remove skid plate grille (WP 0550). Disconnect main wire harness main 4 connector. With a test lead set, check for continuity across main wire harness wire 2162 (white) from main wire harness main 4 connector, terminal R to main wire harness PTO solenoid connector, terminal B.
- a. If there is continuity, repair wire 2162 in cab instrument panel wire harness if repairable (TM 9-2320-325-14&P), or replace cab instrument panel wire harness (WP 0440).
  - b. If there is no continuity, repair wire 2162 in main wire harness if repairable (TM 9-2320-325-14&P), or replace main wire harness (WP 0455).

**MALFUNCTION**

**TEST OR INSPECTION**

**CORRECTIVE ACTION**

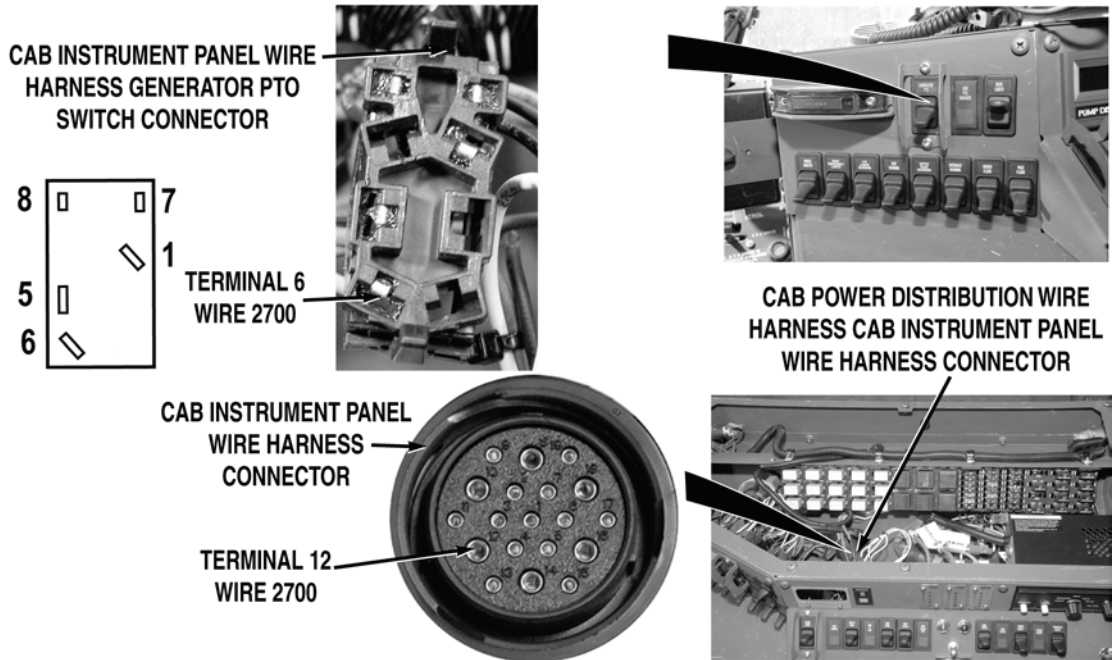

- Step 11. Turn battery disconnect switch to OFF position (WP 0007). Disconnect cab power distribution wire harness cab instrument panel wire harness connector. With a test lead set, check for continuity across cab instrument panel wire harness connector wire 2700 (red) terminal 12, to cab instrument panel wire harness GENERATOR PTO switch connector, terminal 6.
- a. If there is continuity, repair wire 2700 in cab power distribution wire harness if repairable (TM 9-2320-325-14&P), or replace cab power distribution wire harness and block (WP 0441).
  - b. If there is no continuity, repair wire 2700 in cab instrument panel wire harness if repairable (TM 9-2320-325-14&P), or replace cab instrument panel wire harness (WP 0440).

**END OF TASK**

**FOLLOW-ON MAINTENANCE**

Remove wheel chocks (TM 9-2320-347-10)

**END OF TASK**

**END OF WORK PACKAGE**

**FIELD LEVEL MAINTENANCE**

**WATER TANK DRAIN VALVE DOES NOT OPERATE WHEN SELECTED**

**INITIAL SETUP:**

**Tools and Special Tools**

- Lead Set, Test (WP 0622, Item 21)
- Tool Kit, General Mechanic's: Automotive (WP 0622, Item 27)

**References**

- TM 9-2320-325-14&P
- WP 0004
- WP 0007
- WP 0019
- WP 0279
- WP 0311
- WP 0325
- WP 0337
- WP 0398

**References (continued)**

- WP 0441
- WP 0443
- WP 0455
- WP 0459
- WP 0463
- WP 0499
- WP 0539
- WP 0540
- WP 0550
- WP 0567

**Equipment Conditions**

- Water pump engine OFF (WP 0022)
- Engine OFF (TM 9-2320-347-10)
- Wheels chocked (TM 9-2320-347-10)

**MALFUNCTION**

**TEST OR INSPECTION**

**CORRECTIVE ACTION**

**WATER TANK DRAIN VALVE DOES NOT OPERATE WHEN SELECTED**

---

**MALFUNCTION****TEST OR INSPECTION****CORRECTIVE ACTION**

---

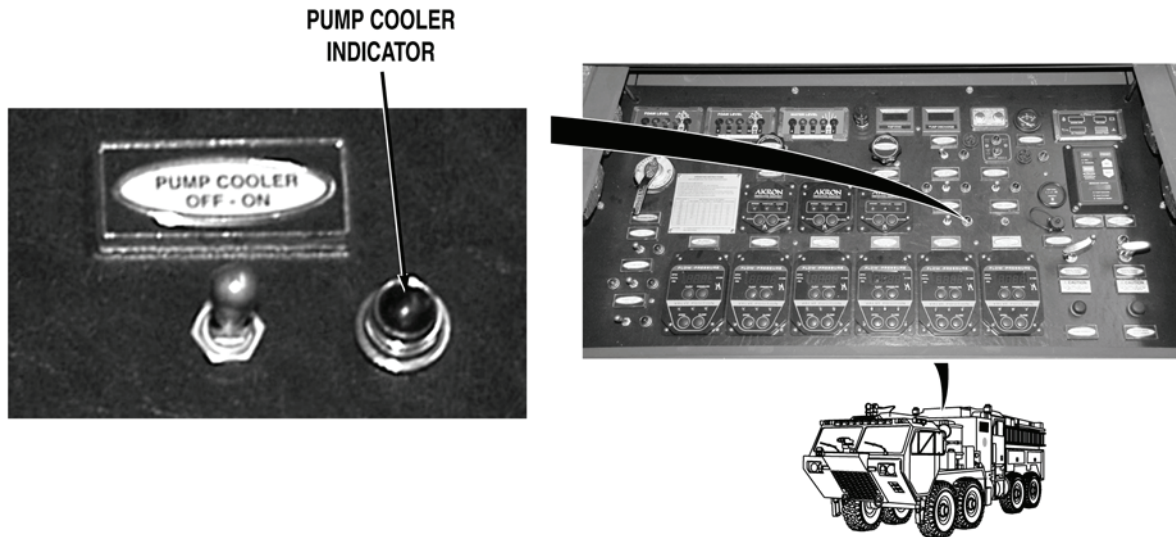

- Step 1. Turn battery disconnect switch to ON position (WP 0007). Open pump operator's panel cover (WP 0019). Put pump operator's panel PUMP COOLER switch to ON position (WP 0004) and release. Check if pump operator's panel PUMP COOLER indicator illuminates.

If pump operator's panel PUMP COOLER indicator does not illuminate, go to Step 11.

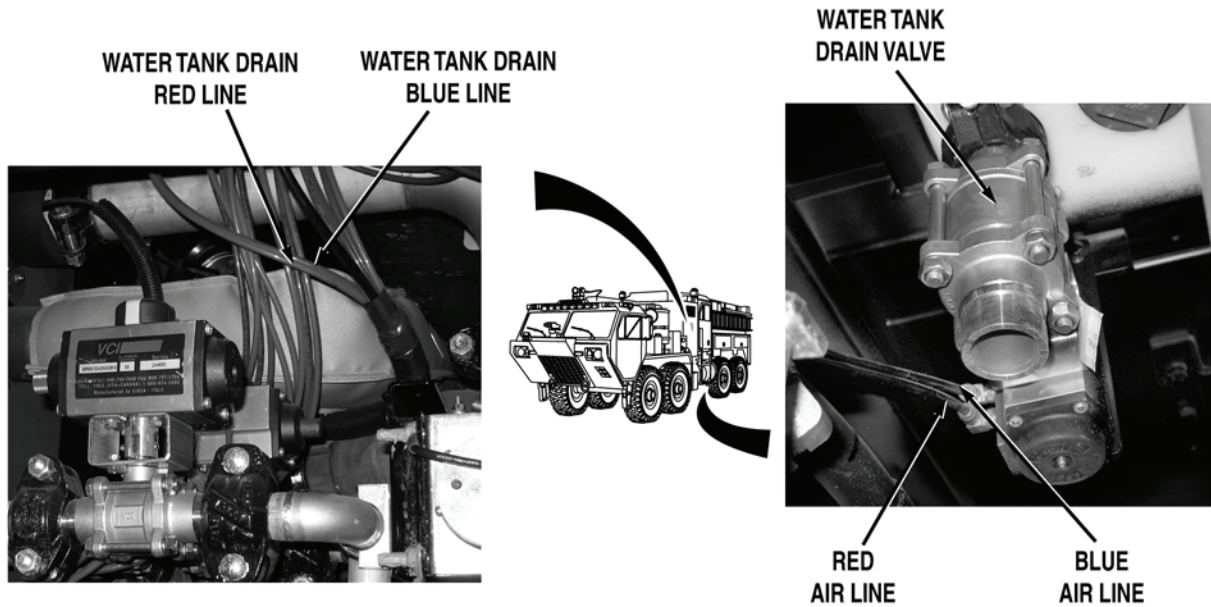

**MALFUNCTION****TEST OR INSPECTION****CORRECTIVE ACTION**

Step 2. Put PUMP COOLER switch to OFF position (WP 0004) and release. Open pump house panel A (WP 0539). Check air lines from air control valve manifold to water tank drain valve for leaks, kinks, or damage.

If air lines are not free from leaks, kinks, or damage, replace damaged air lines (WP 0567).

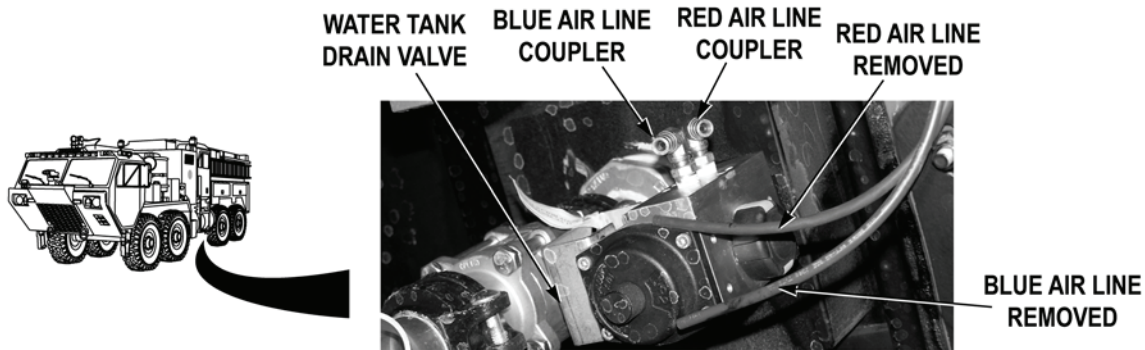
**MALFUNCTION****TEST OR INSPECTION****CORRECTIVE ACTION****WARNING**

- If air lines are under pressure when they are disconnected, they can whip around and cause injury to personnel. Caution should be exercised when disconnecting air line fittings.
- Air lines may be under pressure when control valve is operated. If under pressure, and air lines are disconnected, air lines may whip around and cause injury to personnel. Caution should be exercised when operating control valve with air lines disconnected.

**NOTE**

- Ensure system air pressure is at least 85 psi (586 kPa) during this procedure. System air pressure is required to activate valves.
- Do not engage water pump engine during this procedure, except when performing complete system checks. Valve operations can be checked without water pump operation.
- Do not operate WATER TANK DRAIN switch with blue air line connected to water tank drain valve. If water tank drain opens inadvertently, water will discharge uncontrollably.
- Air pressure is checked by disconnecting air lines at water tank drain valve and observing air pressure escaping from air line, when water tank drain control valve is activated. Air will escape from blue air line when WATER TANK DRAIN switch is put to OPEN position, and escape from red air line when WATER TANK DRAIN switch is put to CLOSED position. System air pressure may drop below 85 psi (586 kPa) during this procedure.

**MALFUNCTION****TEST OR INSPECTION****CORRECTIVE ACTION**

- Step 3. If system air pressure is below 85 psi (586 kPa), start vehicle engine and allow system air pressure to build to at least 85 psi (586 kPa) (TM 9-2320-347-10). Shut off vehicle engine (TM 9-2320-347-10). Disconnect air lines at water tank drain valve. While an assistant puts pump operator's panel WATER TANK DRAIN switch to OPEN and CLOSED positions (WP 0004), check if air pressure is present at water tank drain valve blue and red air lines.

If there is air pressure, replace water tank drain valve (WP 0279).

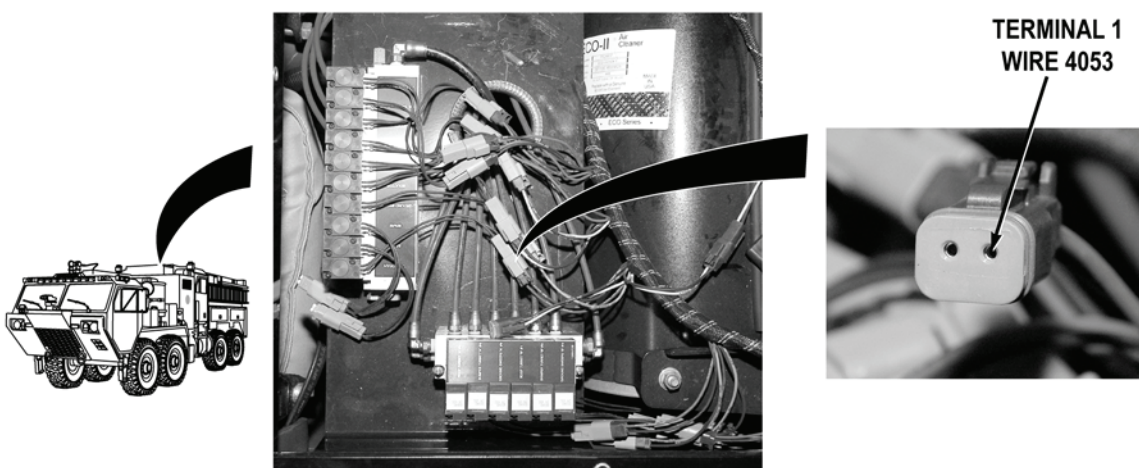
**WARNING**

**Remove rings, wristwatches, neck chains, and any other jewelry before working around vehicle. Jewelry can catch on equipment and cause serious injury. Jewelry and tools may short across electrical circuits and cause damage to equipment, or severe burns or electrical shock to personnel.**

- Step 4. Put WATER TANK DRAIN switch to CLOSED position (WP 0004). Connect air lines at water tank drain valve. Disconnect valve control wire harness water tank drain control valve connector. Put pump operator's panel WATER TANK DRAIN switch to OPEN position (WP 0004). With a test lead set, check for 22 to 28 VDC between valve control wire harness wire 4053 (brown) at water tank drain control valve connector, terminal 1 and a known good ground.

If 22 to 28 VDC are not present, go to Step 6.

---

**MALFUNCTION****TEST OR INSPECTION****CORRECTIVE ACTION**

---

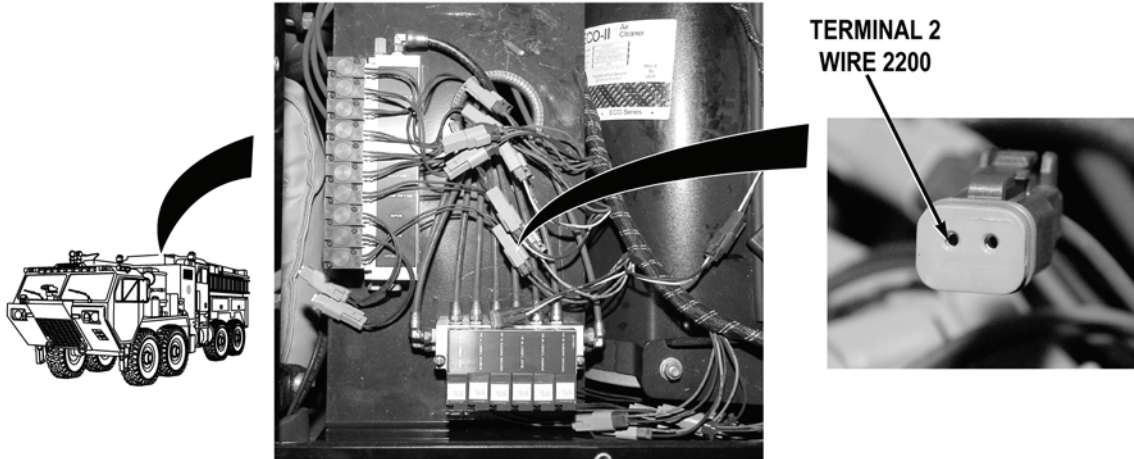

- Step 5. Put WATER TANK DRAIN switch to CLOSED position (WP 0004). Turn battery disconnect switch to OFF position (WP 0007). With a test lead set, check for continuity across wire 2200 (black) from valve control wire harness water tank drain control valve connector, terminal 2 to a known good ground.
- a. If there is continuity, replace water tank drain control valve (WP 0279).
  - b. If there is no continuity, repair wire 2200 in valve control wire harness if repairable (TM 9-2320-325-14&P), or replace valve control wire harness (WP 0463).

---

**MALFUNCTION**  
**TEST OR INSPECTION**  
**CORRECTIVE ACTION**

---



**WATER TANK  
DRAIN INDICATOR**

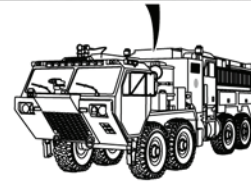
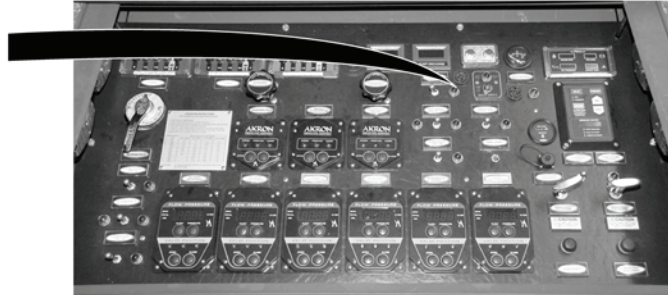

- Step 6. Check if pump operator's panel WATER TANK DRAIN open indicator is illuminated (WP 0004).

If indicator is not illuminated, go to Step 9.

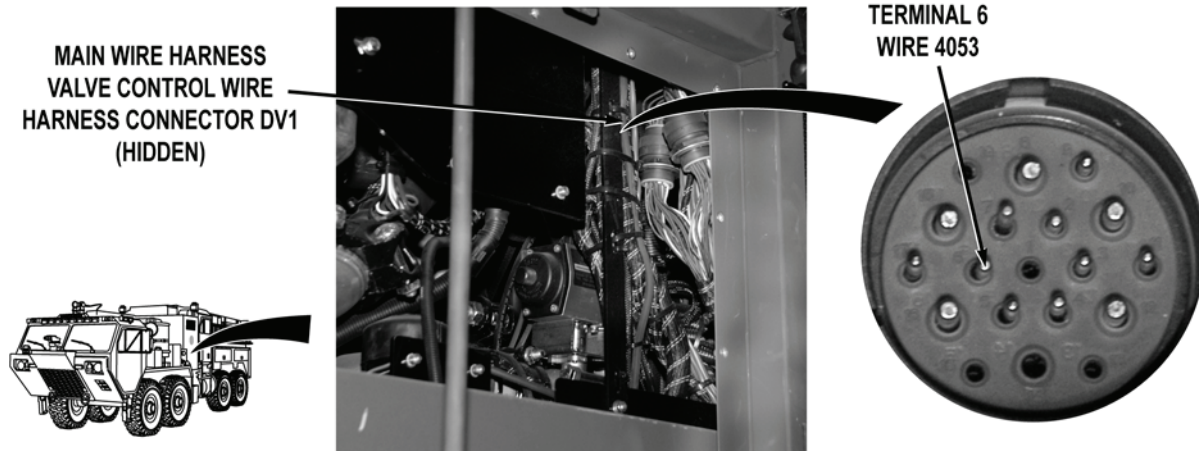
**MALFUNCTION****TEST OR INSPECTION****CORRECTIVE ACTION****WARNING**

**Remove rings, wristwatches, neck chains, and any other jewelry before working around vehicle. Jewelry can catch on equipment and cause serious injury. Jewelry and tools may short across electrical circuits and cause damage to equipment, or severe burns or electrical shock to personnel.**

- Step 7. Turn battery disconnect switch to OFF position (WP 0007). Remove driver side crew cab access panel (WP 0499). Remove pump house panel Q (WP 0540). Disconnect main wire harness valve control wire harness connector DV1. Turn battery disconnect switch to ON position (WP 0007). With a test lead set, check for 22 to 28 VDC between main wire harness wire 4053 (brown) at main wire harness valve control wire harness connector DV1, terminal 6 and a known good ground.

If 22 to 28 VDC are present, repair wire 4053 in valve control wire harness if repairable (TM 9-2320-325-14&P), or replace valve control wire harness (WP 0463).

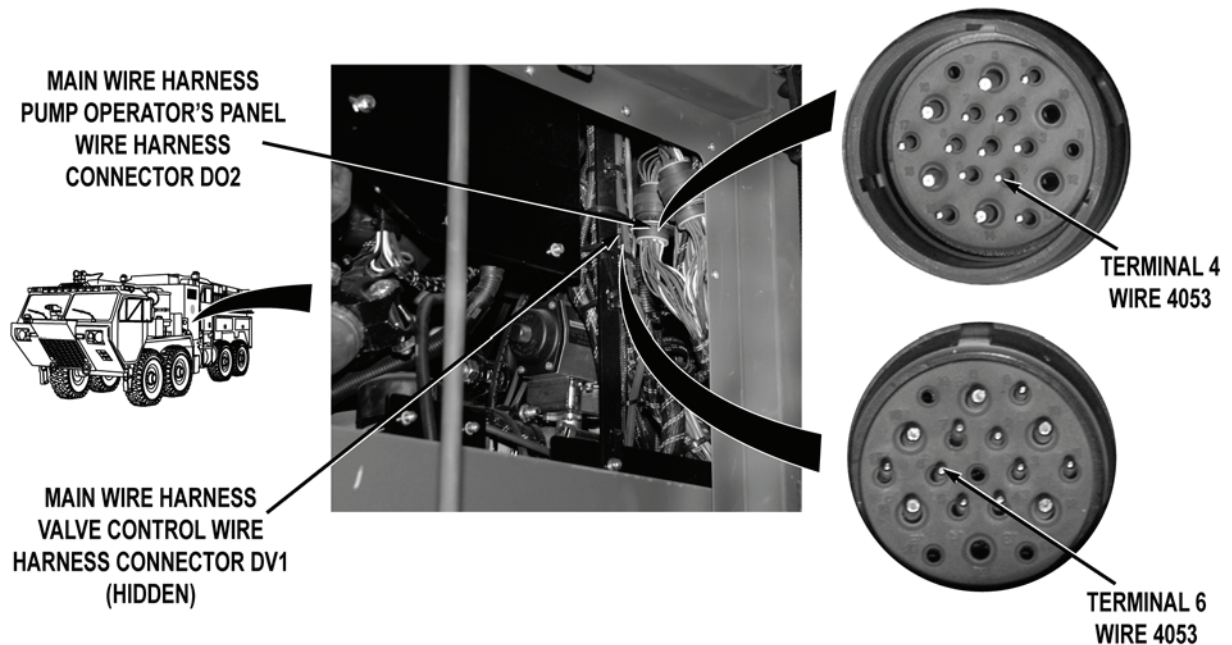
**MALFUNCTION****TEST OR INSPECTION****CORRECTIVE ACTION**

- Step 8. Put pump operator's panel WATER TANK DRAIN switch to CLOSED position (WP 0004). Turn battery disconnect switch to OFF position (WP 0007). Disconnect main wire harness pump operator's panel wire harness connector D02. With a test lead set, check for continuity across main wire harness wire 4053 (brown) from main wire harness pump operator's panel wire harness connector D02, terminal 4 to main wire harness valve control wire harness connector DV1, terminal 6.
- a. If there is continuity, repair wire 4053 in pump operator's panel wire harness if repairable (TM 9-2320-325-14&P), or replace pump operator's panel wire harness (WP 0459).
  - b. If there is no continuity, repair wire 4053 in main wire harness if repairable (TM 9-2320-325-14&P), or replace main wire harness (WP 0455).

## MALFUNCTION

## TEST OR INSPECTION

## CORRECTIVE ACTION

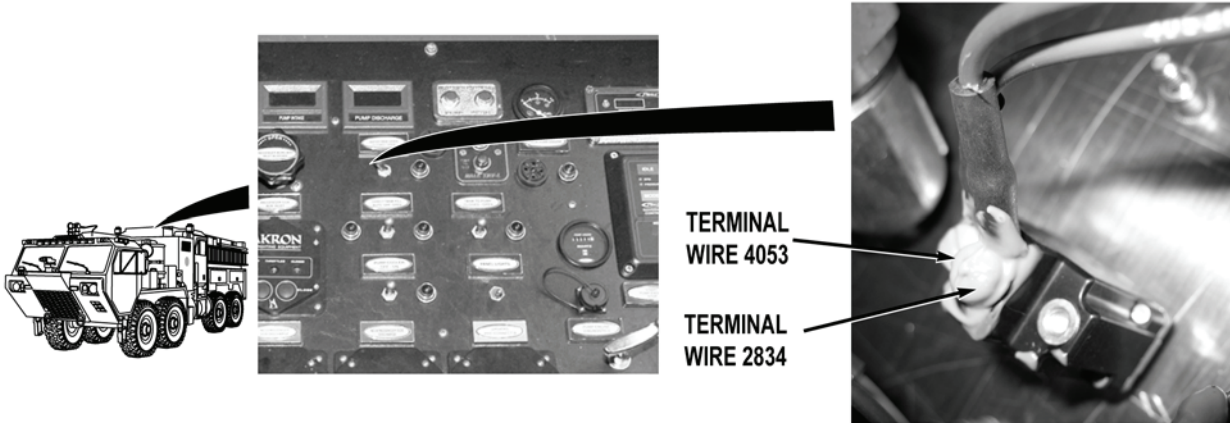
**WARNING**

**Remove rings, wristwatches, neck chains, and any other jewelry before working around vehicle. Jewelry can catch on equipment and cause serious injury. Jewelry and tools may short across electrical circuits and cause damage to equipment, or severe burns or electrical shock to personnel.**

- Step 9. Turn battery disconnect switch to OFF position (WP 0007). Open pump operator's panel housing (WP 0325). Turn battery disconnect switch to ON position (WP 0007). With a test lead set, check for 22 to 28 VDC between pump operator's panel wire harness wire 2834 (red) at WATER TANK DRAIN switch terminal and a known good ground.

If 22 to 28 VDC are not present, repair wire 2834 in pump operator's panel wire harness if repairable (TM 9-2320-325-14&P), or replace pump operator's panel wire harness (WP 0459).

- Step 10. Turn battery disconnect switch to OFF position (WP 0007). With a test lead set, check for continuity across WATER TANK DRAIN switch from terminal wire 2834 (red) to terminal wire 4053 (brown), while switch is in OPEN position.
- a. If there is continuity, repair wire 4053 in pump operator's panel wire harness if repairable (TM 9-2320-325-14&P), or replace pump operator's panel wire harness (WP 0459).
  - b. If there is no continuity, replace WATER TANK DRAIN switch (WP 0337).



**MALFUNCTION**

**TEST OR INSPECTION**

**CORRECTIVE ACTION**



**CAB PUMP COOLER INDICATOR**

Step 11. Put pump operator's panel PUMP COOLER switch to OFF position (WP 0004). Put cab PUMP COOLER switch to on position (WP 0004) and release. Check if cab PUMP COOLER OPEN indicator illuminates.

If cab PUMP COOLER OPEN indicator does not illuminate, go to Step 14.

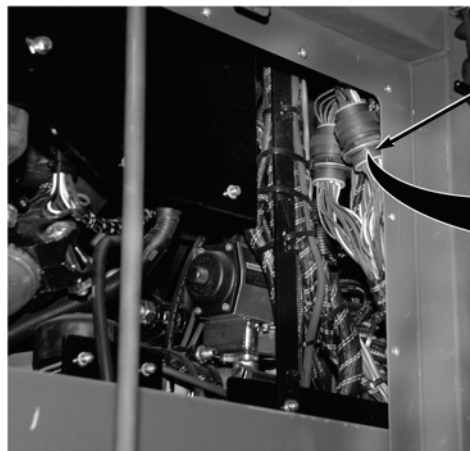

**MAIN WIRE HARNESS  
PUMP OPERATOR'S PANEL  
WIRE HARNESS CONNECTOR DO1**

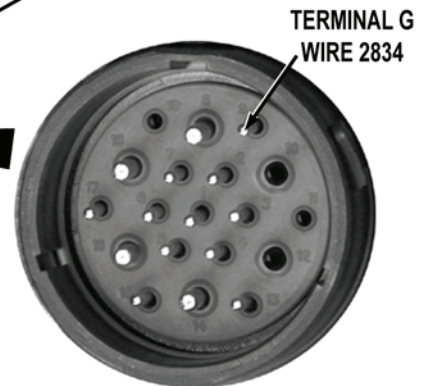

**TERMINAL G  
WIRE 2834**

Step 12. Turn battery disconnect switch to OFF position (WP 0007). Remove driver side crew cab access panel (WP 0499). Remove pump house panel Q (WP 0540). Put cab PUMP COOLER switch to off position (WP 0004). Disconnect main wire harness pump operator's panel wire harness connector DO1. Turn battery disconnect switch to ON position (WP 0007). With a test lead set, check for 22 to 28 VDC between main wire harness wire 2834 (red) at main wire harness pump operator's panel wire harness connector DO1, terminal G and a known good ground.

If 22 to 28 VDC are present, repair wire 2834 in pump operator's panel wire harness if repairable (TM 9-2320-325-14&P), or replace pump operator's panel wire harness (WP 0459).

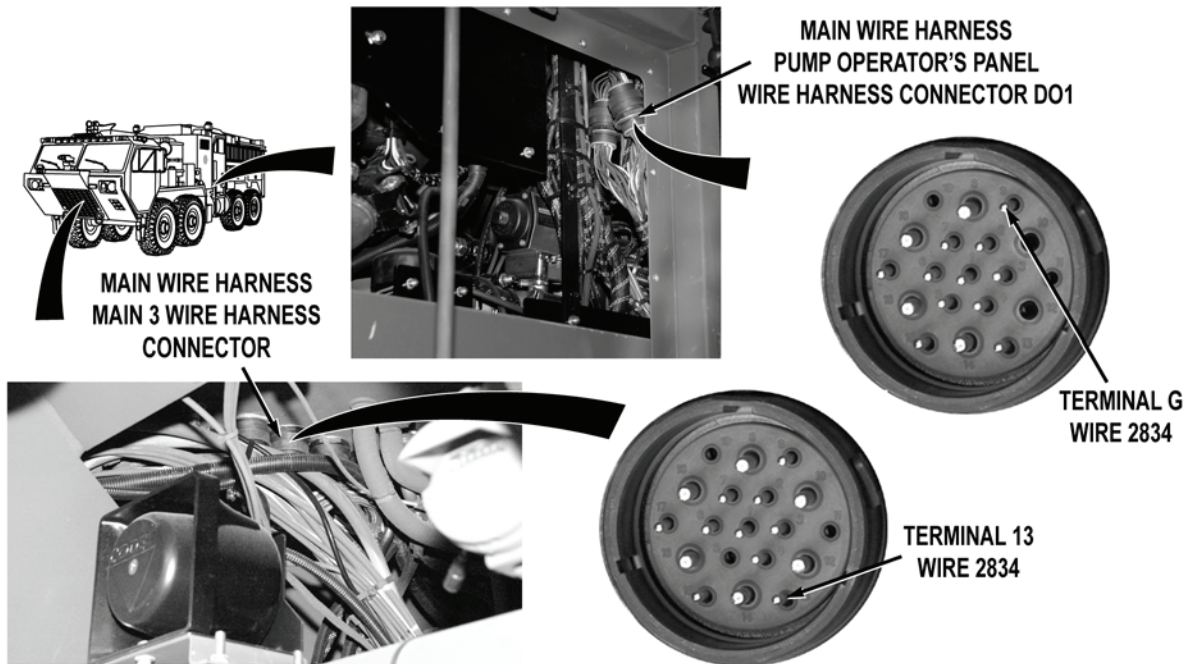
**MALFUNCTION****TEST OR INSPECTION****CORRECTIVE ACTION**

- Step 13. Remove skid plate grille (WP 0550). Turn battery disconnect switch to OFF position (WP 0007). Disconnect main wire harness main 3 connector. With a test lead set, check for continuity across main wire harness wire 2834 (red) from main 3 connector, terminal 13 to main wire harness pump operator's panel wire harness connector DO1, terminal G.

If there is no continuity, repair wire 2834 in main wire harness if repairable (TM 9-2320-325-14&P), or replace main wire harness (WP 0455).

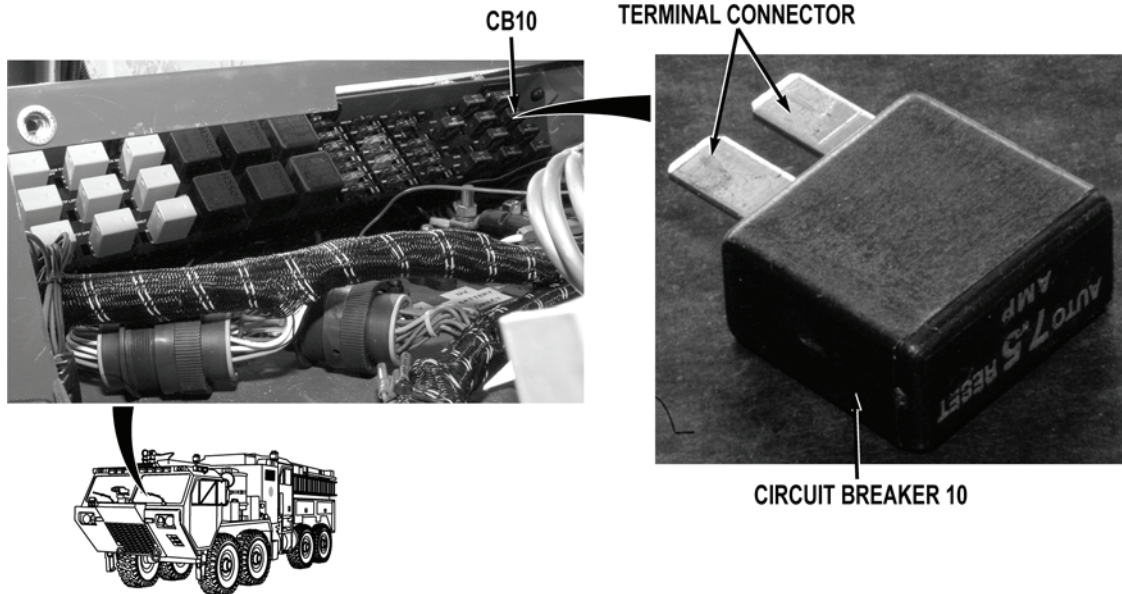
**MALFUNCTION****TEST OR INSPECTION****CORRECTIVE ACTION****WARNING**

**Remove rings, wristwatches, neck chains, and any other jewelry before working around vehicle. Jewelry can catch on equipment and cause serious injury. Jewelry and tools may short across electrical circuits and cause damage to equipment, or severe burns or electrical shock to personnel.**

- Step 14. Turn battery disconnect switch to OFF position (WP 0007). Remove personnel cab instrument panel A (WP 0311). Remove circuit breaker 10 (WP 0398). Check for continuity across circuit breaker.

If there is no continuity, replace circuit breaker 10 (WP 0398).

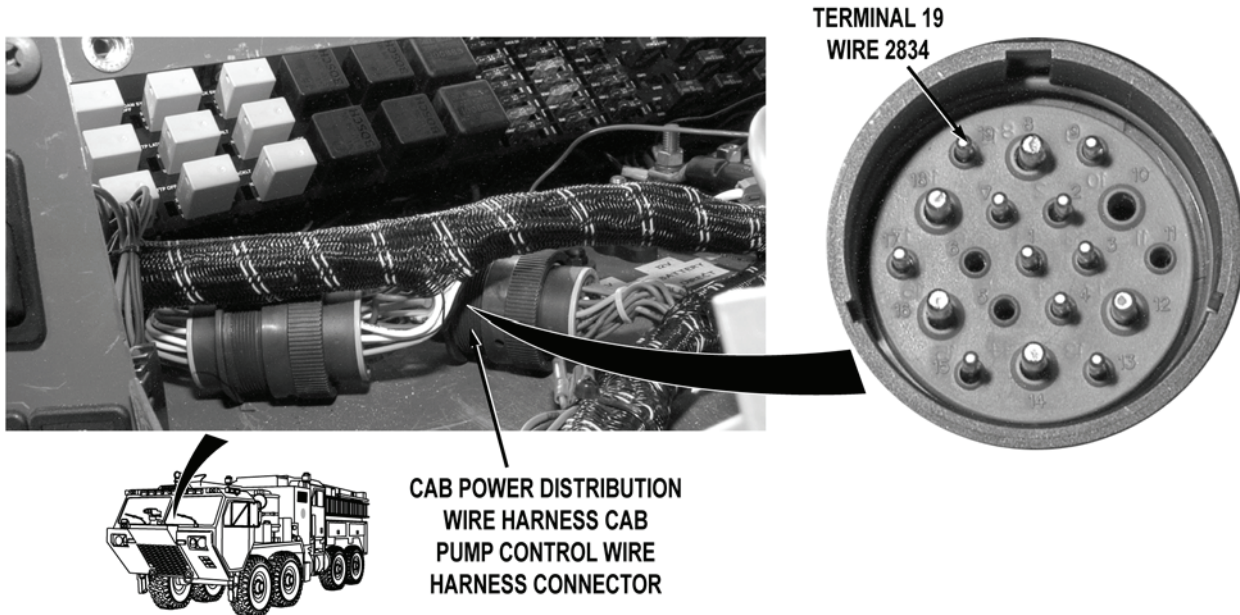
**MALFUNCTION****TEST OR INSPECTION****CORRECTIVE ACTION**

**CAB POWER DISTRIBUTION  
WIRE HARNESS CAB  
PUMP CONTROL WIRE  
HARNESS CONNECTOR**

- Step 15. Disconnect cab power distribution wire harness cab pump control wire harness connector. Turn battery disconnect switch to ON position (WP 0007). With a test lead set, check for 22 to 28 VDC at cab power distribution wire harness connector wire 2834 (red), terminal 19 and a known good ground.
- a. If 22 to 28 VDC are present, repair wire 2834 in cab pump control wire harness if repairable (TM 9-2320-325-14&P), or replace cab pump control wire harness (WP 0443).
  - b. If 22 to 28 VDC are not present, repair wire 2834 in cab power distribution wire harness if repairable (TM 9-2320-325-14&P), or replace cab power distribution wire harness and block (WP 0441).

**END OF TASK****FOLLOW-ON MAINTENANCE**

1. Install skid plate grille (if removed) (WP 0550)
2. Remove wheel chocks (TM 9-2320-347-10)

**END OF TASK****END OF WORK PACKAGE**

**FIELD LEVEL MAINTENANCE**

**WATER TANK LEVEL INDICATOR GAUGE DOES NOT OPERATE PROPERLY**

**INITIAL SETUP:**

**Tools and Special Tools**

- Lead Set, Test (WP 0622, Item 21)
- Tool Kit, General Mechanic's: Automotive (WP 0622, Item 27)

**References**

- TM 9-2320-325-14&P
- WP 0004
- WP 0007
- WP 0019
- WP 0020
- WP 0297
- WP 0311
- WP 0316

**References (continued)**

- WP 0325
- WP 0339
- WP 0401
- WP 0441
- WP 0443
- WP 0444
- WP 0455
- WP 0459
- WP 0499
- WP 0540
- WP 0550

**Equipment Conditions**

- Water pump engine OFF (WP 0022)
- Engine OFF (TM 9-2320-347-10)
- Wheels chocked (TM 9-2320-347-10)

**MALFUNCTION**

**TEST OR INSPECTION**

**CORRECTIVE ACTION**

**WATER TANK LEVEL INDICATOR GAUGE DOES NOT OPERATE PROPERLY**

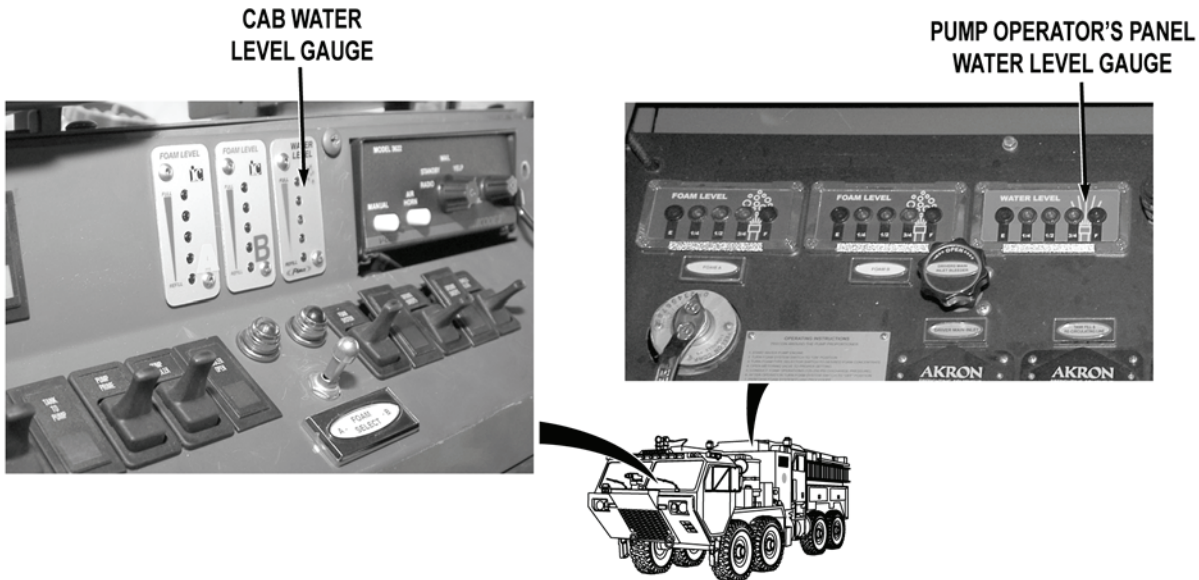
**MALFUNCTION****TEST OR INSPECTION****CORRECTIVE ACTION****NOTE**

- WATER LEVEL gauge indicators operate as follows: “E” indicator will flash when water level in tank is below 1/4 full. “E” and “1/4” indicators will illuminate when water tank is 1/4 full. “E”, “1/4” and “1/2” indicators will illuminate when water tank is 1/2 full. “E”, “1/4”, “1/2”, and “3/4” indicators will illuminate when water tank is 3/4 full. All indicators will illuminate when water tank is full.
- WATER LEVEL gauge “E” indicator will illuminate or flash whenever power is applied to gauge.

Step 1. Turn battery disconnect switch to ON position (WP 0007). Open pump operator's panel cover (WP 0019). With water tank filled (WP 0020), check if cab and pump operator's panel WATER LEVEL gauge indicators illuminate or flash (WP 0004).

If cab and pump operator's panel WATER LEVEL gauge indicators do not illuminate or flash, go to Step 11.

Step 2. Check if only pump operator's panel WATER LEVEL gauge indicators illuminate or flash (WP 0004).

If cab WATER LEVEL gauge indicators do not illuminate or flash, go to Step 9.

Step 3. With water tank filled (WP 0020), check if cab and pump operator's panel WATER LEVEL gauge readings are equal (WP 0004).

If cab and pump operator's panel WATER LEVEL gauge readings are not equal, go to Step 9.

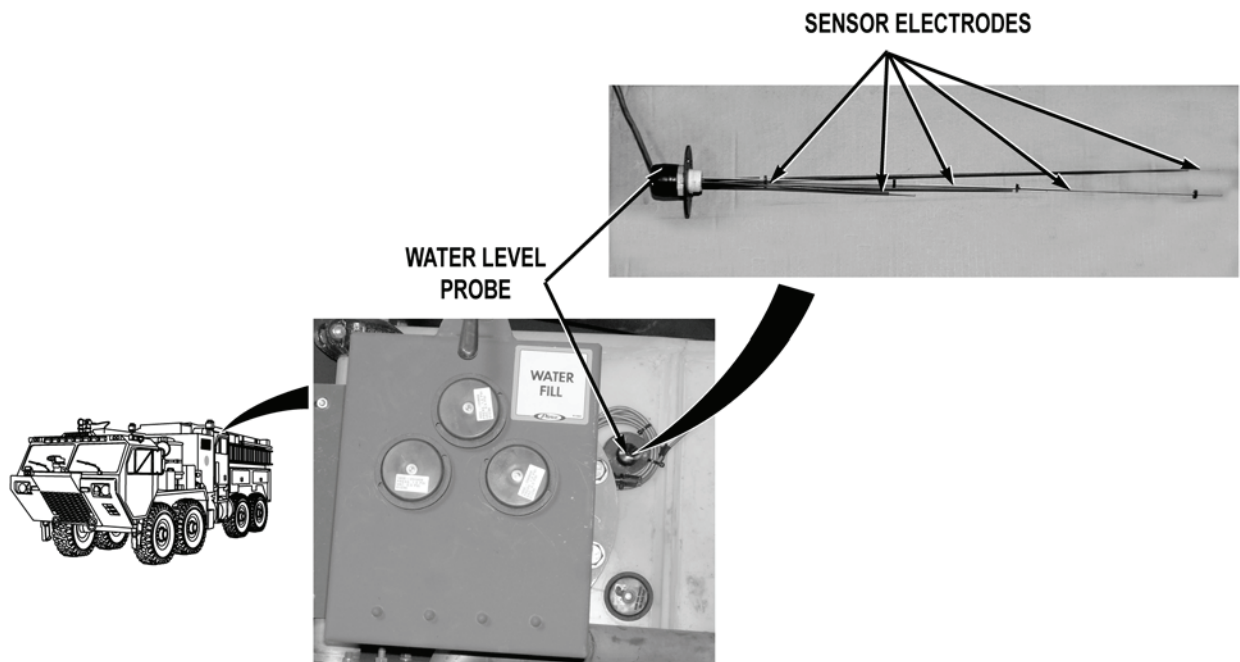
**MALFUNCTION****TEST OR INSPECTION****CORRECTIVE ACTION****WARNING**

**Remove rings, wristwatches, neck chains, and any other jewelry before working around vehicle. Jewelry can catch on equipment and cause serious injury. Jewelry and tools may short across electrical circuits and cause damage to equipment, or severe burns or electrical shock to personnel.**

- Step 4. Remove water level probe (WP 0297). Remove setscrew and sensor element from tube. Check sensor electrodes for hard water deposits.

If hard water deposits have formed on sensor electrodes, clean sensor electrodes and go to Step 5.

## MALFUNCTION

## TEST OR INSPECTION

## CORRECTIVE ACTION

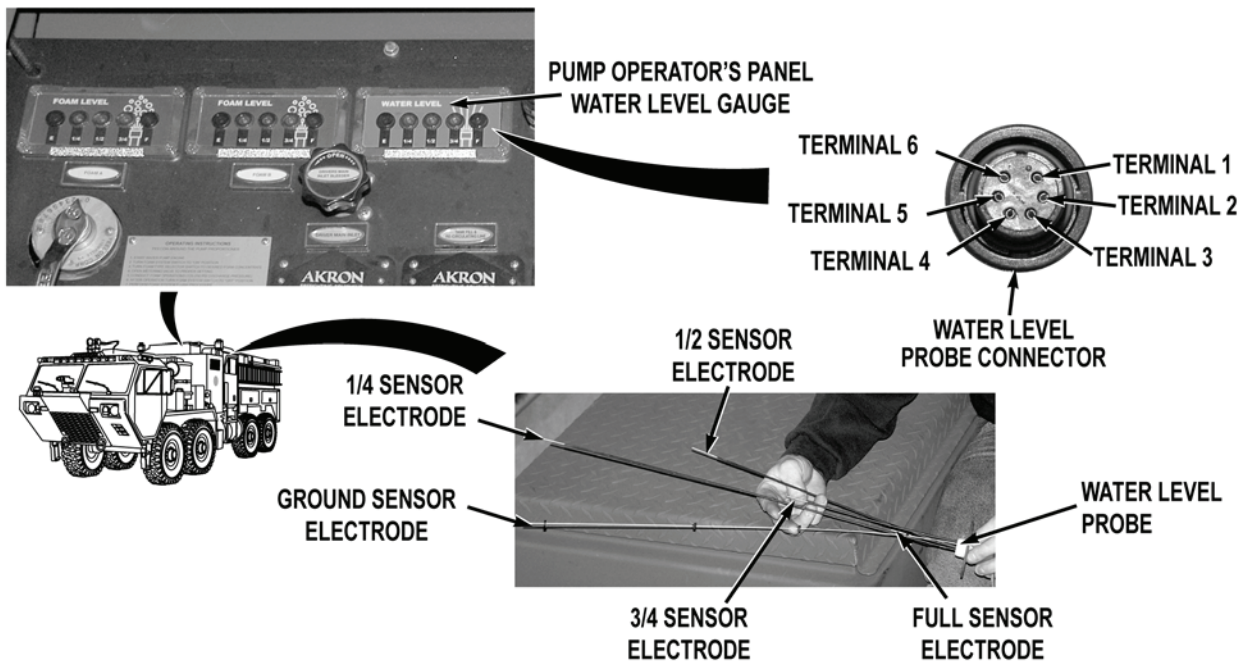

- Step 5. Open pump operator's panel housing (WP 0325). Disconnect water level probe connector from pump operator's panel water level gauge connector. With a test lead set, check for continuity across sensor electrodes as follows. Check for continuity from water level probe connector, terminal 2 to tip of 1/4 sensor electrode. Note reading. Check for continuity from water level probe connector, terminal 3 to tip of 1/2 sensor electrode. Note reading. Check for continuity from water level probe connector, terminal 4 to tip of 3/4 sensor electrode. Note reading. Check for continuity from water level probe connector, terminal 5 to tip of full sensor electrode. Note reading. Check for continuity from water level probe connector, terminal 6 to tip of ground sensor electrode. Note reading.

If there is no continuity across any sensor electrode, replace water level probe (WP 0297).

- Step 6. Check for 12K to 16K ohms resistance between water level probe connector, terminals 1 and 2. Note reading. Repeat resistance checks for terminals 1 and 3, 1 and 4, and 1 and 5.

If resistance is not between 12K and 16K ohms for any sensor electrode, replace water level probe (WP 0297).

- Step 7. Check for greater than 1M ohms resistance between water level probe connector, terminals 6 and 2. Note reading. Repeat resistance checks for terminals 6 and 3, 6 and 4, and 6 and 5.

If resistance is less than 1M ohms for any sensor electrodes, replace water level probe (WP 0297).

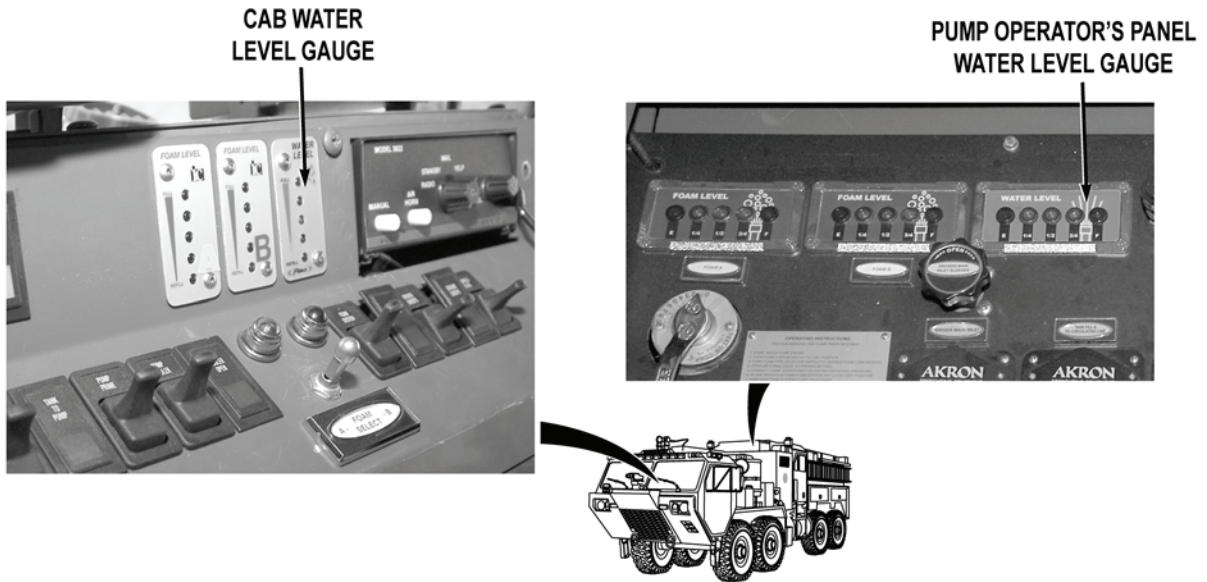

**MALFUNCTION****TEST OR INSPECTION****CORRECTIVE ACTION**

- Step 8. Assemble and install water level probe (WP 0297). Connect water level probe connector to pump operator's panel water level gauge, if removed. Turn battery disconnect switch to ON position (WP 0007). Check if cab and pump operator's panel WATER LEVEL gauges indicate correct water level in water tank.
- a. If gauges indicate correct water level in tank, fault has been corrected.
  - b. If gauges do not indicate correct water level in tank, replace pump operator's panel WATER LEVEL gauge (WP 0339).

**MALFUNCTION**

**TEST OR INSPECTION**

**CORRECTIVE ACTION**

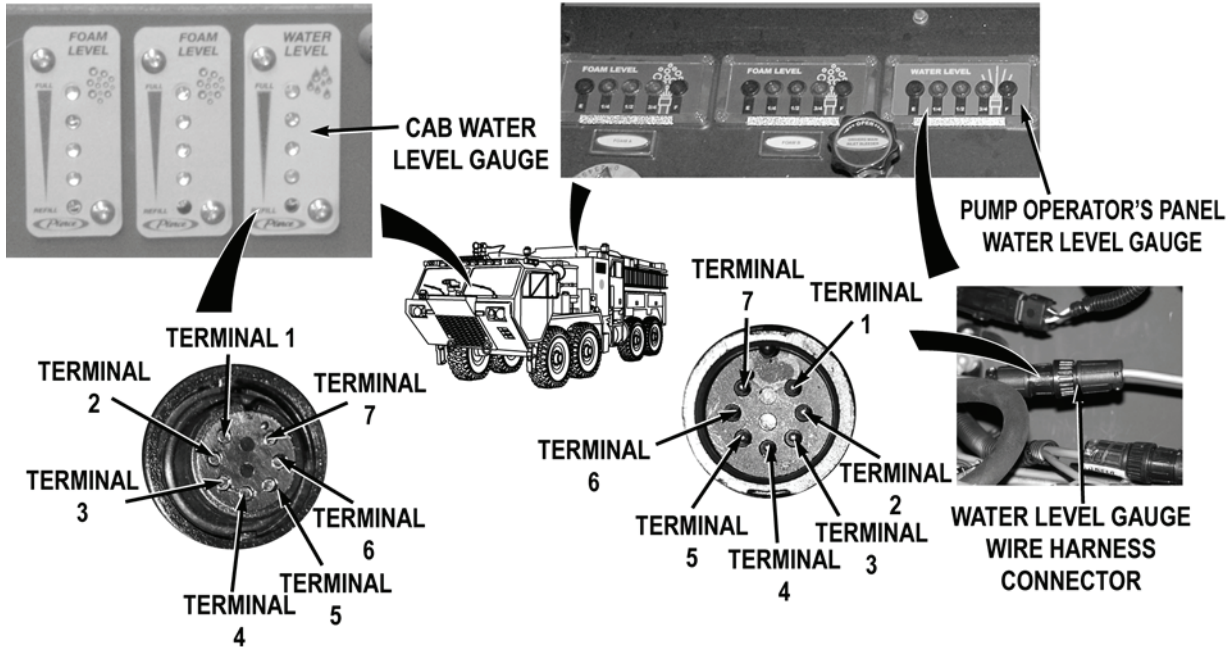

**WARNING**



Remove rings, wristwatches, neck chains, and any other jewelry before working around vehicle. Jewelry can catch on equipment and cause serious injury. Jewelry and tools may short across electrical circuits and cause damage to equipment, or severe burns or electrical shock to personnel.

- Step 9. Turn battery disconnect switch to OFF position (WP 0007). Open pump operator's panel housing (WP 0325). Disconnect cab water level gauge wire harness connector from pump operator's panel WATER LEVEL gauge. Remove cab instrument panel B (WP 0311). Disconnect cab water level gauge wire harness connector from cab WATER LEVEL gauge. With a test lead set, check for continuity across cab water level gauge wire harness from pump operator's panel WATER LEVEL gauge connector, terminal 1 to cab WATER LEVEL gauge connector, terminal 1. Note reading. Repeat continuity checks for terminals 2 to 2, 3 to 3, 4 to 4, 5 to 5, 6 to 6, and 7 to 7.

If there is no continuity for any pair of terminals, replace cab water tank level gauge wire harness (WP 0444).

**MALFUNCTION**  
**TEST OR INSPECTION**  
**CORRECTIVE ACTION**

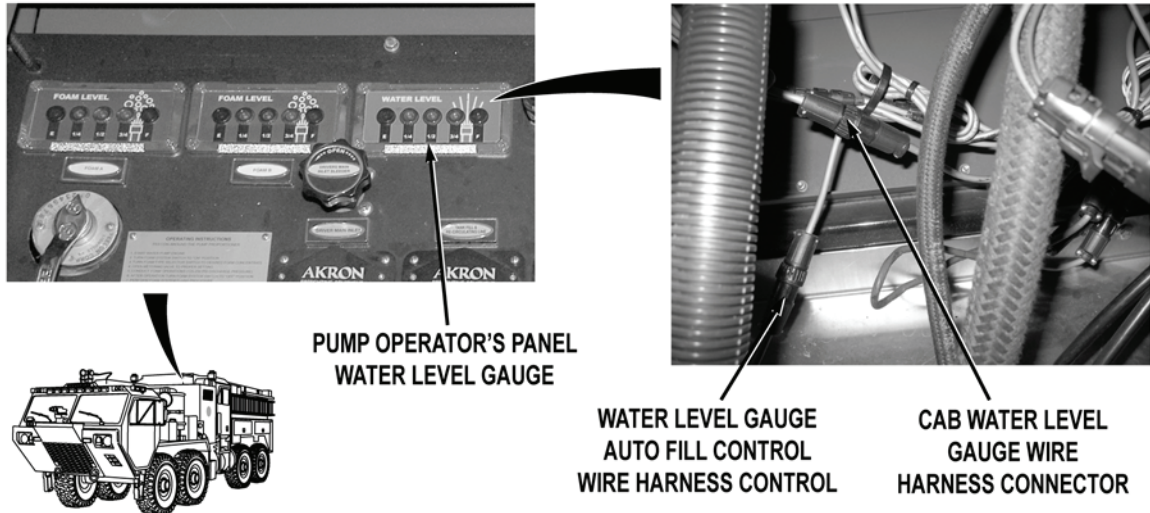

- Step 10. Connect cab water level gauge wire harness connector to cab WATER LEVEL gauge. Disconnect water level gauge auto fill control wire harness connector from pump operator's panel WATER LEVEL gauge. Connect cab water level gauge wire harness connector to pump operator's panel WATER LEVEL gauge auto fill wire harness connector. Turn battery disconnect switch to ON position (WP 0007). Check if cab WATER LEVEL gauge indicates correct water level in water tank.
- a. If cab WATER LEVEL gauge indicates correct water level in tank, replace pump operator's panel WATER LEVEL gauge (WP 0339).
  - b. If cab WATER LEVEL gauge does not indicate correct water level in tank, replace personnel cab WATER LEVEL gauge (WP 0316).

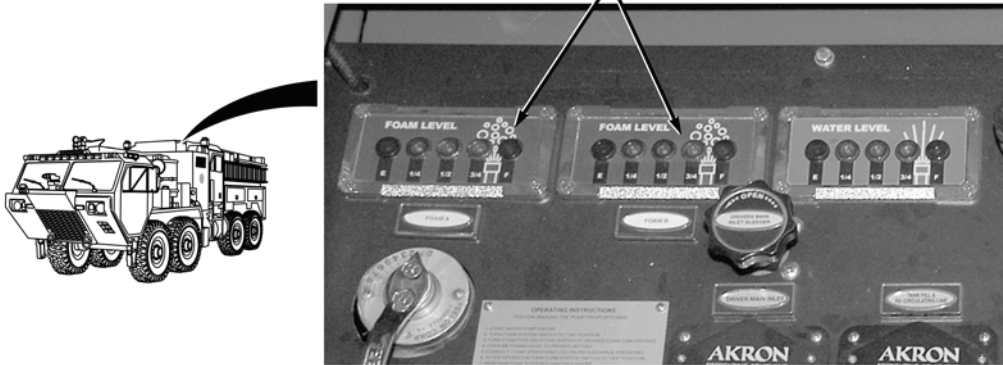
**MALFUNCTION****TEST OR INSPECTION****CORRECTIVE ACTION****PUMP OPERATOR'S PANEL  
FOAM LEVEL GAUGES****WARNING**

**Remove rings, wristwatches, neck chains, and any other jewelry before working around vehicle. Jewelry can catch on equipment and cause serious injury. Jewelry and tools may short across electrical circuits and cause damage to equipment, or severe burns or electrical shock to personnel.**

Step 11. Check if pump operator's panel FOAM LEVEL gauge indicators illuminate or flash.

If pump operator's panel FOAM LEVEL gauge indicators do not illuminate or flash, go to Step 14.

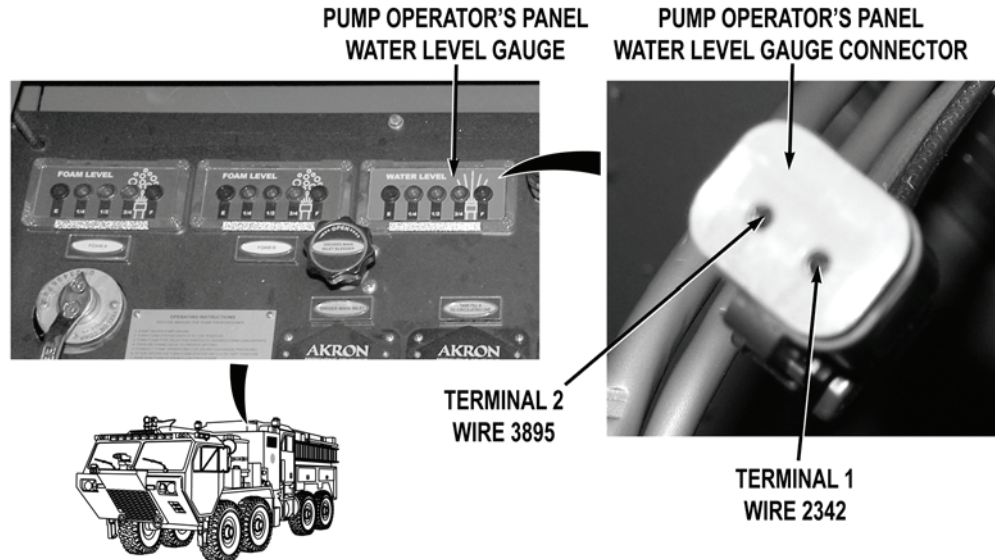
**MALFUNCTION****TEST OR INSPECTION****CORRECTIVE ACTION**

- Step 12. Turn battery disconnect switch to OFF position (WP 0007). Open pump operator's panel housing (WP 0325). Turn battery disconnect switch to ON position (WP 0007). Disconnect pump operator's panel wire harness WATER LEVEL gauge connector. With a test lead set, check for 22 to 28 VDC between wire 2342 (red) at pump operator's panel wire harness WATER LEVEL gauge connector, terminal 1 and a known good ground.

If 22 to 28 VDC are not present, repair wire 2342 in pump operator's panel wire harness if repairable (TM 9-2320-325-14&P), or replace pump operator's panel wire harness (WP 0459).

- Step 13. Turn battery disconnect switch to OFF position (WP 0007). With a test lead set, check for continuity across pump operator's panel wire harness wire 3895 from WATER LEVEL gauge connector, terminal 2 to a known good ground.
- a. If there is continuity, replace pump operator's panel WATER LEVEL gauge (WP 0339).
  - b. If there is no continuity, repair wire 3895 in pump operator's panel wire harness if repairable (TM 9-2320-325-14&P), or replace pump operator's panel wire harness (WP 0459).

## MALFUNCTION

## TEST OR INSPECTION

## CORRECTIVE ACTION

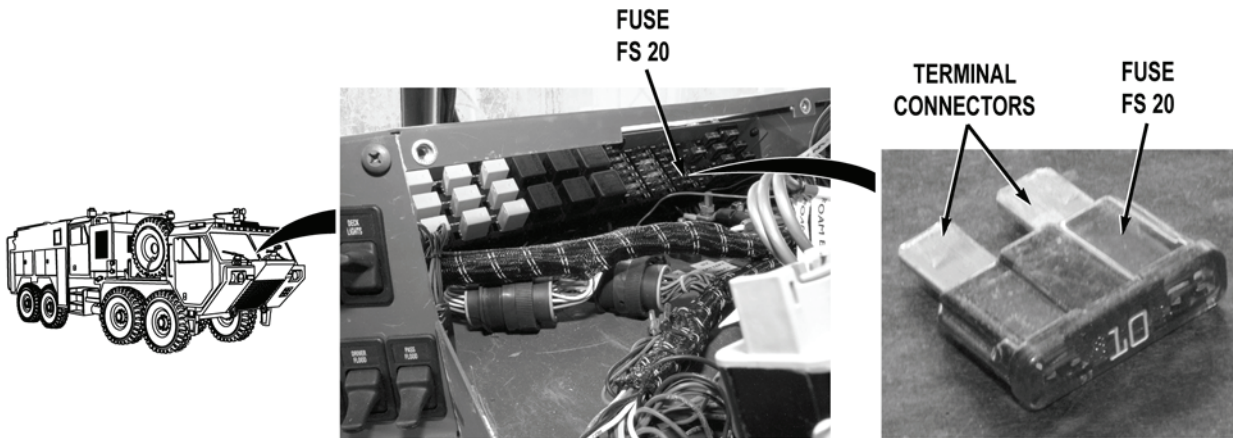
**WARNING**

**Remove rings, wristwatches, neck chains, and any other jewelry before working around vehicle. Jewelry can catch on equipment and cause serious injury. Jewelry and tools may short across electrical circuits and cause damage to equipment, or severe burns or electrical shock to personnel.**

- Step 14. Turn battery disconnect switch to OFF position (WP 0007). Remove cab instrument panel A (WP 0311). Remove fuse FS 20 (WP 0401). Check for continuity across fuse.

If there is no continuity, replace fuse FS 20 (WP 0401).

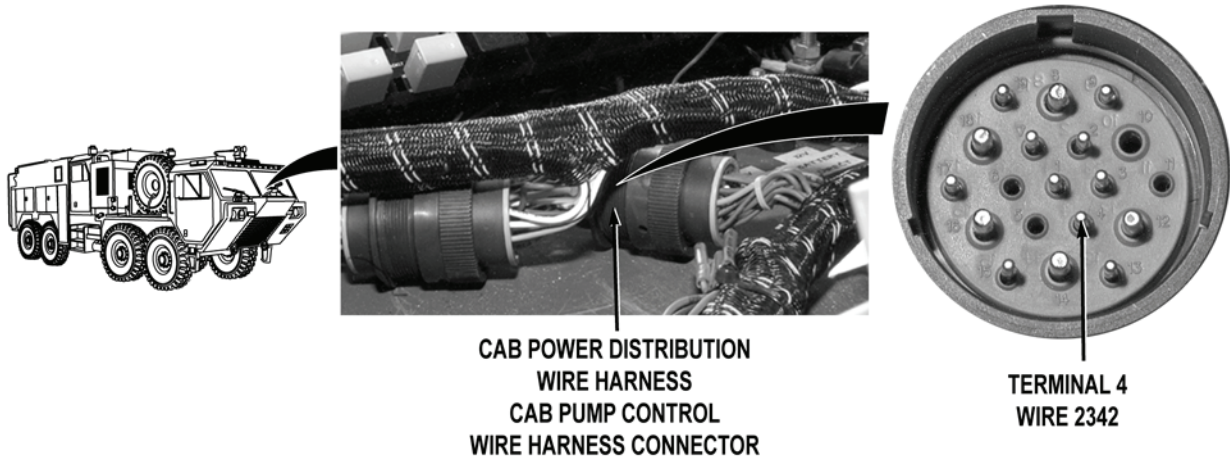
**MALFUNCTION****TEST OR INSPECTION****CORRECTIVE ACTION**

- Step 15. Install fuse FS 20 (WP 0401). Disconnect cab pump control wire harness cab power distribution wire harness connector. Turn battery disconnect switch to ON position (WP 0007). With a test lead set, check for 22 to 28 VDC between cab power distribution wire harness wire 2342 (red) at cab pump control wire harness cab power distribution wire harness connector, terminal 4 and a known good ground.

If 22 to 28 VDC are not present, repair wire 2342 in cab power distribution wire harness if repairable (TM 9-2320-325-14&P), or replace cab power distribution wire harness and block (WP 0441).

---

**MALFUNCTION****TEST OR INSPECTION****CORRECTIVE ACTION**

---

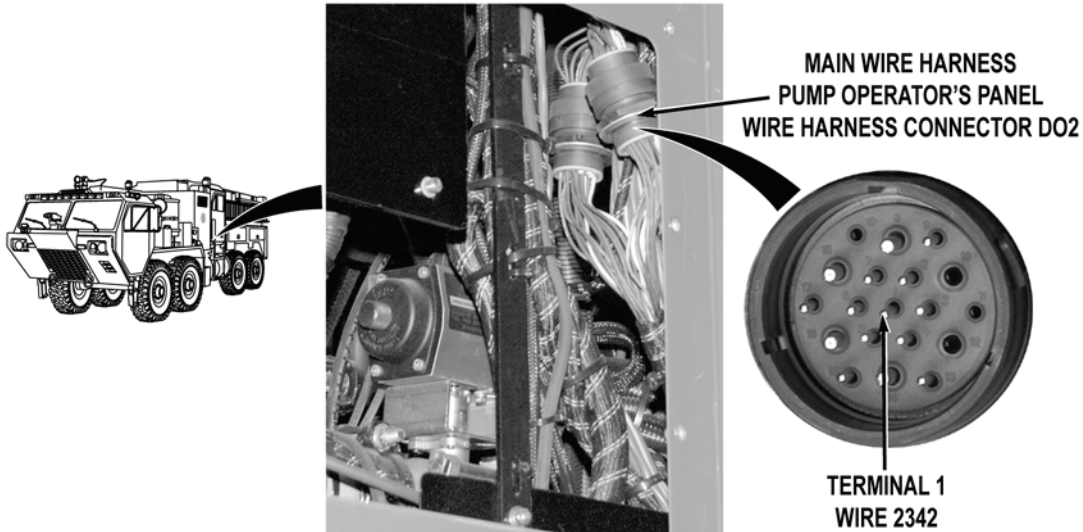

- Step 16. Remove driver side crew cab access panel (WP 0499). Remove pump house panel Q (WP 0540). Connect cab pump control wire harness cab power distribution wire harness connector DO2. Disconnect main wire harness pump operator's panel wire harness connector. With a test lead set, check for 22 to 28 VDC between main wire harness wire 2342 (red) at main wire harness pump operator's panel wire harness connector DO2, terminal 1 and a known good ground.

If 22 to 28 VDC are not present, go to Step 18.

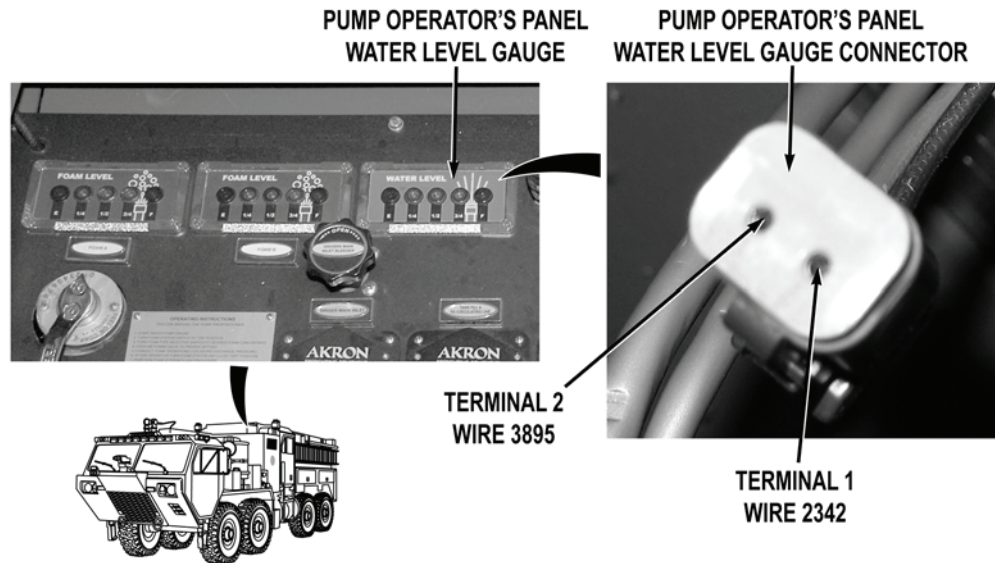

**MALFUNCTION****TEST OR INSPECTION****CORRECTIVE ACTION**

- Step 17. Turn battery disconnect switch to OFF position (WP 0007). Open pump operator's panel housing (WP 0325). Disconnect pump operator's panel wire harness WATER LEVEL gauge connector. With a test lead set, check for continuity across pump operator's panel wire harness wire 3895 (black) from WATER LEVEL gauge connector, terminal 2 to a known good ground.
- a. If there is continuity, repair wire 2342 in pump operator's panel wire harness if repairable (TM 9-2320-325-14&P), or replace pump operator's panel wire harness (WP 0459).
  - b. If there is no continuity, repair wire 3895 in pump operator's panel wire harness if repairable (TM 9-2320-325-14&P), or replace pump operator's panel wire harness (WP 0459).

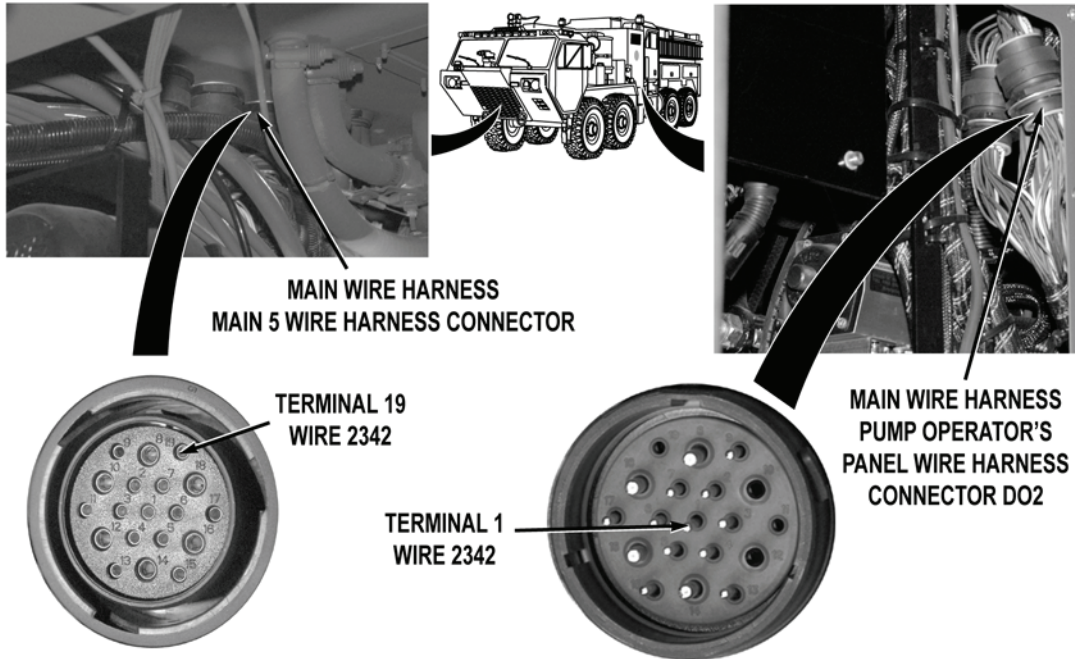
**MALFUNCTION****TEST OR INSPECTION****CORRECTIVE ACTION**

- Step 18. Turn battery disconnect switch to OFF position (WP 0007). Remove skid plate grille (WP 0550). Disconnect main wire harness main 5 connector. With a test lead set, check for continuity across main wire harness wire 2342 (red) from main 5 connector, terminal 19 to main wire harness pump operator's panel wire harness connector DO2, terminal 1.
- a. If there is continuity, repair wire 2342 in cab pump control harness if repairable (TM 9-2320-325-14&P), or replace cab pump control wire harness (WP 0443).
  - b. If there is no continuity, repair wire 2342 in main wire harness if repairable (TM 9-2320-325-14&P), or replace main wire harness (WP 0455).

**END OF TASK****FOLLOW-ON MAINTENANCE**

Remove wheel chocks (TM 9-2320-347-10)

**END OF TASK****END OF WORK PACKAGE**

**FIELD LEVEL MAINTENANCE**

**WATER PUMP OUTPUT PRESSURE IS LOW**

**INITIAL SETUP:**

**Tools and Special Tools**

Tool Kit, General Mechanic's: Automotive  
(WP 0622, Item 27)

**References**

WP 0004  
WP 0007  
WP 0022  
WP 0026

**References (continued)**

WP 0027  
WP 0044  
WP 0119  
WP 0127  
WP 0255

**Equipment Conditions**

Water pump engine OFF (WP 0022)  
Engine OFF (TM 9-2320-347-10)  
Wheels chocked (TM 9-2320-347-10)

**MALFUNCTION**

**TEST OR INSPECTION**

**CORRECTIVE ACTION**

**WATER PUMP OUTPUT PRESSURE IS LOW**

**MALFUNCTION**

**TEST OR INSPECTION**

**CORRECTIVE ACTION**

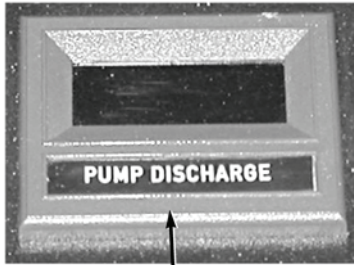

PUMP DISCHARGE  
GAUGE

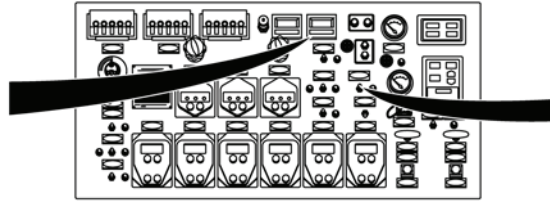

TANK TO PUMP  
SWITCH



- **CARBON MONOXIDE (EXHAUST GAS) CAN CAUSE DEATH**
- Carbon monoxide is without color or smell, but can cause death. Breathing air with carbon monoxide produces symptoms of headache, dizziness, loss of muscular control, a sleepy feeling, and coma. Brain damage or death can result from heavy exposure. Carbon monoxide occurs in the exhaust fumes of fuel-burning heaters and internal combustion engines. Carbon monoxide can become dangerously concentrated under conditions of no ventilation. Precautions must be followed to ensure crew safety when the personnel heater or engine of any vehicle is operated for any purpose.

**CAUTION**

- Water pump is constantly engaged and operates whenever water pump engine is running. At least one water inlet valve must be opened whenever water pump engine is running. A pressure reading on PUMP DISCHARGE gauge (with engine running) indicates adequate water supply to water pump for cooling. Failure to comply may result in water pump overheating and will cause damage to equipment.
- Water pump must be primed when operating water pump engine. Failure to prime water pump when operating water pump engine will cause damage to equipment.

Step 1. Turn battery disconnect switch to ON position (WP 0007). Pump from onboard water tank (WP 0026). Using pump operator's panel PUMP DISCHARGE gauge, check if water pump output pressure is low.

If water pump output is not low, fault corrected.

Step 2. Put TANK TO PUMP switch to CLOSED position (WP 0004). Pump from hydrant or in relay (WP 0027). Using pump operator's panel PUMP DISCHARGE gauge, check if water pump output pressure is low.

If water pump output is not low, troubleshoot Tank-To-Pump Valve(s) Does Not Operate Properly (WP 0119).

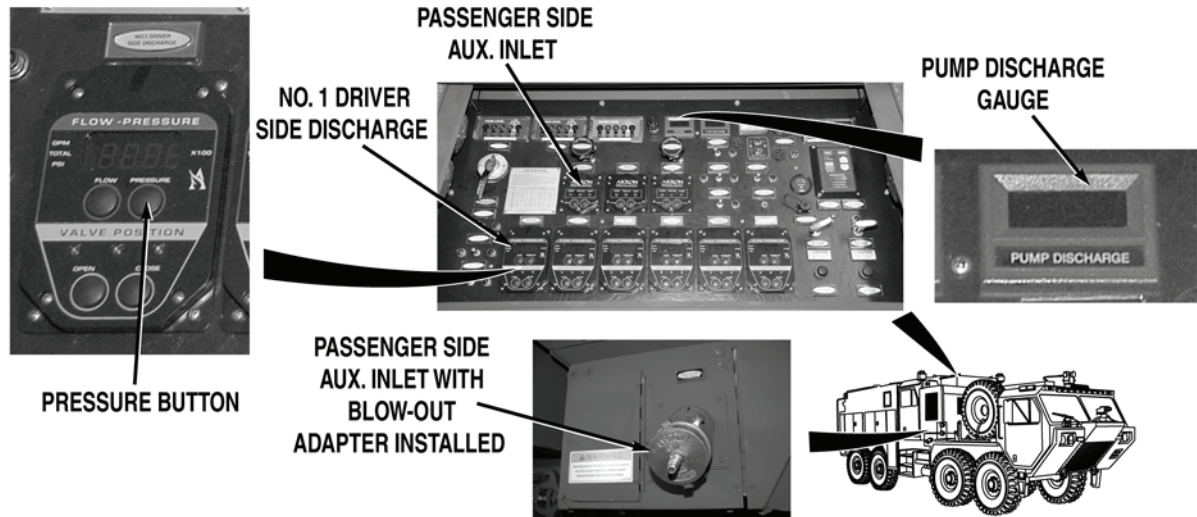
**MALFUNCTION****TEST OR INSPECTION****CORRECTIVE ACTION**

- Step 3. Stop water pump engine (WP 0022). Install discharge and intake caps on vehicle (WP 0004). Install blow-out adapter on PASSENGER SIDE AUX. INLET (WP 0044). Apply 50 psi (345 kPa) shop air to PASSENGER SIDE AUX. INLET. Push PASSENGER SIDE AUX. INLET button to OPEN position (WP 0004). Push NO. 1 DRIVER SIDE DISCHARGE PRESSURE button (WP 0004). Check if pressure indicated at NO. 1 DRIVER SIDE DISCHARGE is equal to value indicated at pump operator's panel PUMP DISCHARGE gauge.
- a. If NO. 1 DRIVER SIDE DISCHARGE value is equal to PUMP DISCHARGE gauge, replace water pump (WP 0255).
  - b. If NO. 1 DRIVER SIDE DISCHARGE value is not equal to PUMP DISCHARGE gauge, troubleshoot Digital Pressure Gauge(s) Does Not Operate (WP 0127).

**END OF TASK****FOLLOW-ON MAINTENANCE**

1. Perform post operations procedures (WP 0041)
2. Remove Blow-out Adapter (if installed) (WP 0044)
3. Remove wheel chocks (TM 9-2320-347-10)

**END OF TASK****END OF WORK PACKAGE**



**FIELD LEVEL MAINTENANCE**

**WINDSHIELD DELUGE SYSTEM DOES NOT OPERATE PROPERLY**

**INITIAL SETUP:**

**Tools and Special Tools**

- Lead Set, Test (WP 0622, Item 21)
- Tool Kit, General Mechanic's: Automotive (WP 0622, Item 27)

**Personnel Required**

- MOS 63B Wheeled vehicle mechanic (2)

**References**

- TM 9-2320-325-14&P
- WP 0004
- WP 0007
- WP 0020
- WP 0311
- WP 0315
- WP 0398
- WP 0412
- WP 0413
- WP 0432

**References (continued)**

- WP 0441
- WP 0443
- WP 0455
- WP 0457
- WP 0458
- WP 0490
- WP 0499
- WP 0539
- WP 0540
- WP 0550
- WP 0561
- WP 0562
- WP 0582

**Equipment Conditions**

- Water pump engine OFF (WP 0022)
- Engine OFF (TM 9-2320-347-10)
- Wheels chocked (TM 9-2320-347-10)

**MALFUNCTION**

**TEST OR INSPECTION**

**CORRECTIVE ACTION**

**WINDSHIELD DELUGE SYSTEM DOES NOT OPERATE PROPERLY**

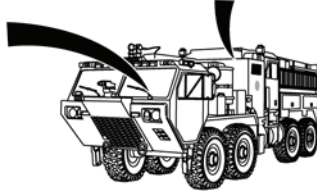
**MALFUNCTION****TEST OR INSPECTION****CORRECTIVE ACTION****CAB WATER LEVEL GAUGE****PUMP OPERATOR'S PANEL  
WATER LEVEL GAUGE**

- Step 1. Turn battery disconnect switch to ON position (WP 0007). Using cab or pump operator's panel WATER LEVEL gauge, check if there is enough water in water tank to operate windshield deluge system.

If water tank is empty, fill tank enough to operate windshield deluge system (WP 0020) and go to Step 2.



---

<b>MALFUNCTION</b>	
<b>TEST OR INSPECTION</b>	
<b>CORRECTIVE ACTION</b>	

---

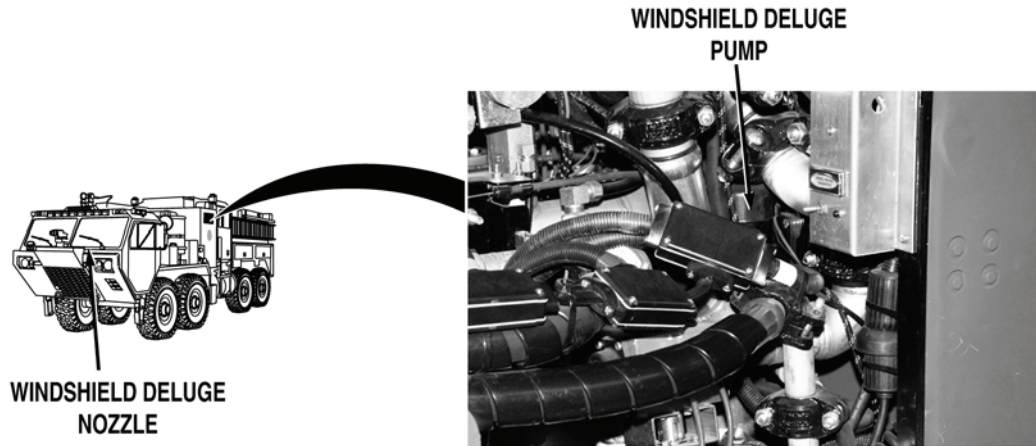
**NOTE**

- Water will be expelled at windshield when operating windshield deluge system. Move vehicle to outside area or place suitable container under windshield.
- Windshield deluge pump motor operation will be checked by listening for a whining sound from windshield deluge pump when WINDSHIELD DELUGE switch is put to on position.

Step 2. Open pump house panel A (WP 0539). Put WINDSHIELD DELUGE switch to on position (WP 0004). Check if windshield deluge pump operates.

If windshield deluge pump does not operate, go to Step 11.

Step 3. Check if water is delivered from at least one windshield deluge nozzle, when windshield deluge system is operating.

If water is not delivered to both windshield deluge nozzles, go to Step 5.

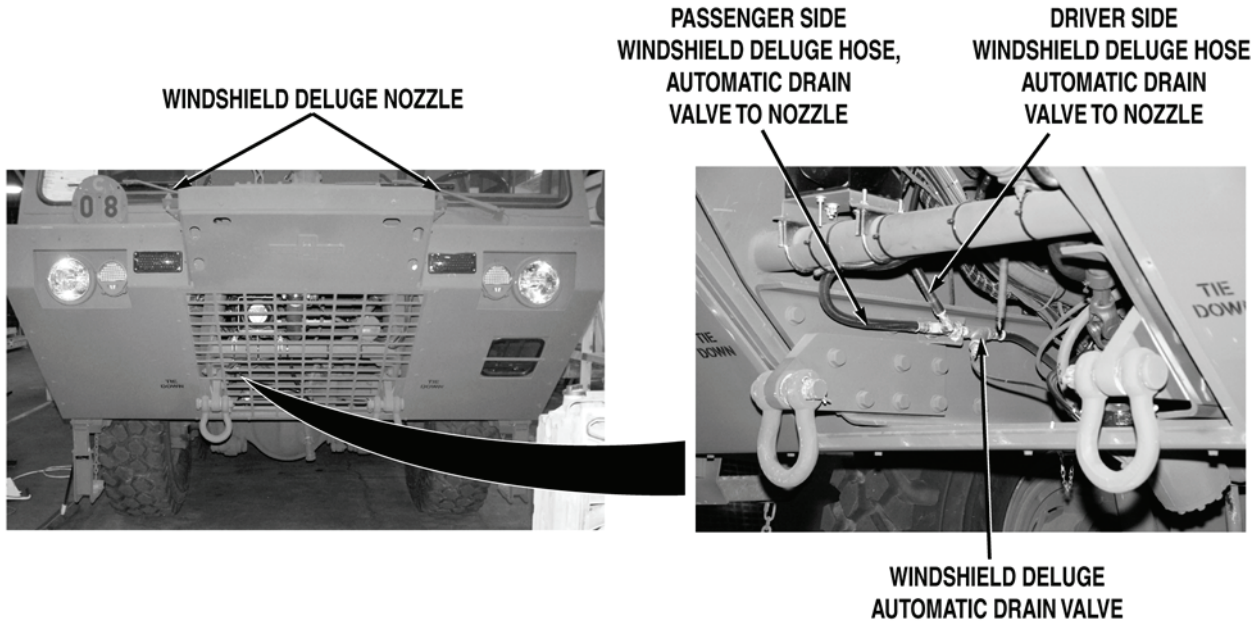
**MALFUNCTION****TEST OR INSPECTION****CORRECTIVE ACTION**

- Step 4. Put WINDSHIELD DELUGE switch to off position (WP 0004). Remove skid plate grille (WP 0550). Check hose from windshield deluge automatic drain valve to non-operating windshield deluge nozzle for leaks, kinks, and damage.
- a. If hose is free from leaks, kinks, and damage, replace non-operating windshield deluge nozzle (WP 0562).
  - b. If hose is not free from leaks, kinks, or damage, replace hose (WP 0490).

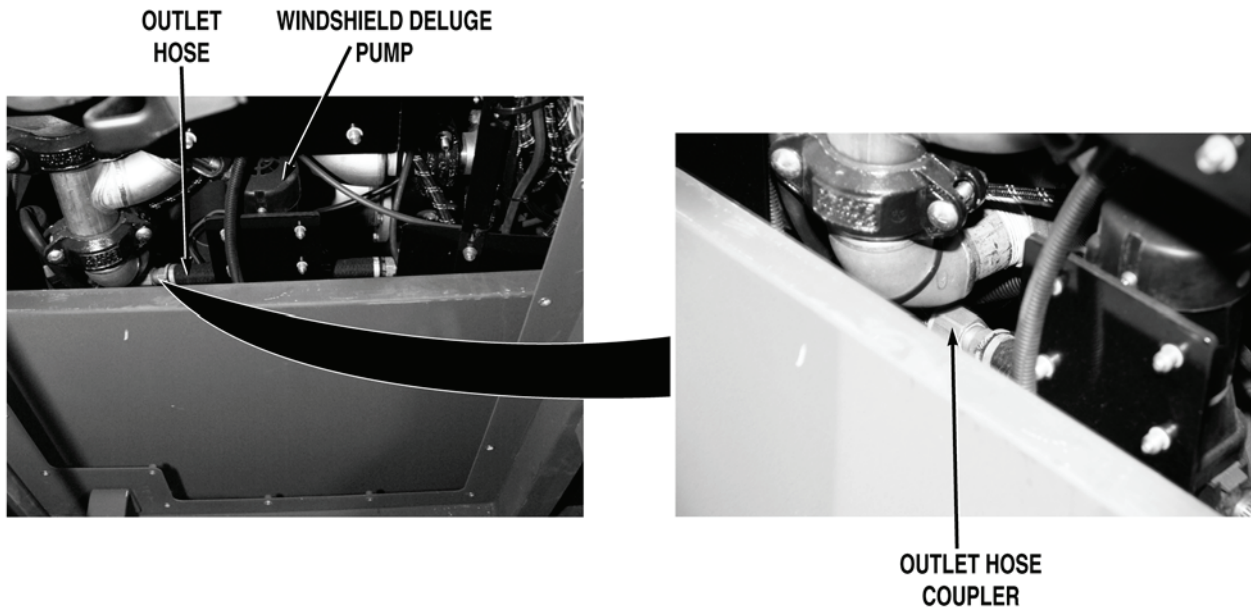
**MALFUNCTION****TEST OR INSPECTION****CORRECTIVE ACTION****NOTE**

Water may be expelled with force at windshield deluge pump when operating windshield deluge system. Place suitable container under windshield pump outlet when performing Step 5.

- Step 5. Remove pump house panel Q (WP 0540). Remove driver side crew cab access panel (WP 0499). Put WINDSHIELD DELUGE switch to off position (WP 0004). Place suitable container under windshield deluge pump outlet. Disconnect hose from windshield deluge pump outlet hose coupler. While an assistant puts WINDSHIELD DELUGE switch to on position (WP 0004), check if water is delivered from windshield deluge pump outlet hose.

If water is not delivered, go to Step 7.

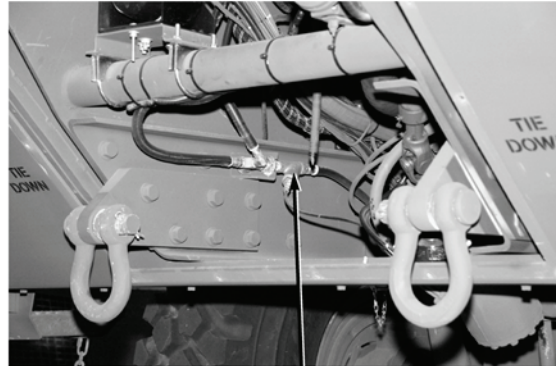
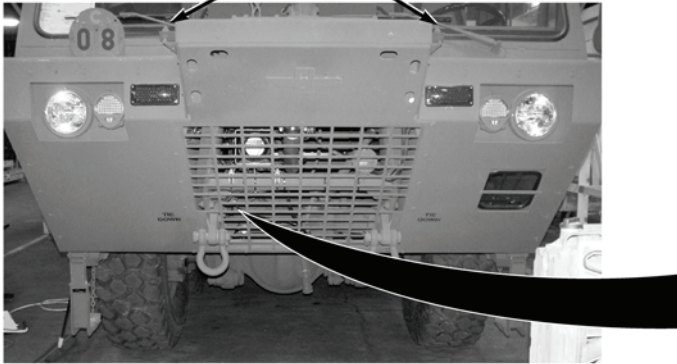
**MALFUNCTION****TEST OR INSPECTION****CORRECTIVE ACTION****WINDSHIELD DELUGE NOZZLE****WINDSHIELD DELUGE  
AUTOMATIC DRAIN VALVE**

- Step 6. Put WINDSHIELD DELUGE switch to off position (WP 0004). Connect hose to windshield deluge pump outlet hose coupler. Remove strainer screen from windshield deluge automatic drain valve (WP 0562). Check if automatic drain valve strainer screen is clogged.
- a. If strainer is free from clogs, replace hose from windshield deluge pump to windshield deluge automatic drain valve (WP 0490).
  - b. If strainer is not free from clogs, clean screen or replace windshield deluge automatic drain valve (WP 0562).

---

**MALFUNCTION****TEST OR INSPECTION****CORRECTIVE ACTION**

---

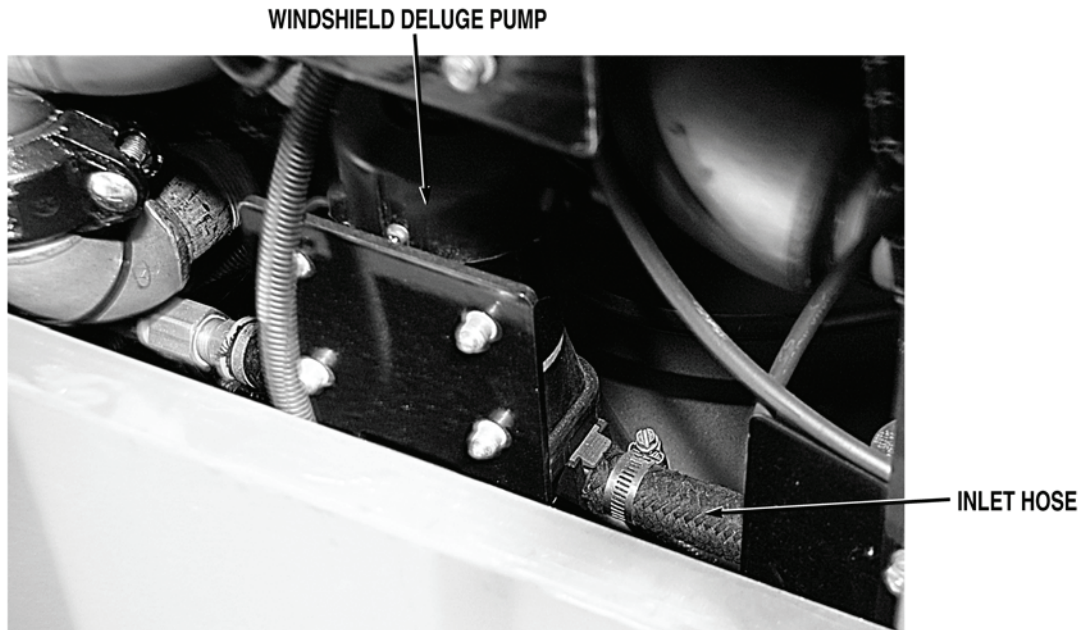

- Step 7. Put WINDSHIELD DELUGE switch to off position (WP 0004). Connect hose to windshield deluge pump outlet coupler. Place suitable container under windshield deluge pump inlet. Disconnect hose from windshield deluge pump inlet (WP 0432). While an assistant puts WINDSHIELD DELUGE switch to on position (WP 0004), check if water is delivered from windshield deluge pump inlet hose.

If water is delivered, replace windshield deluge pump (WP 0432).

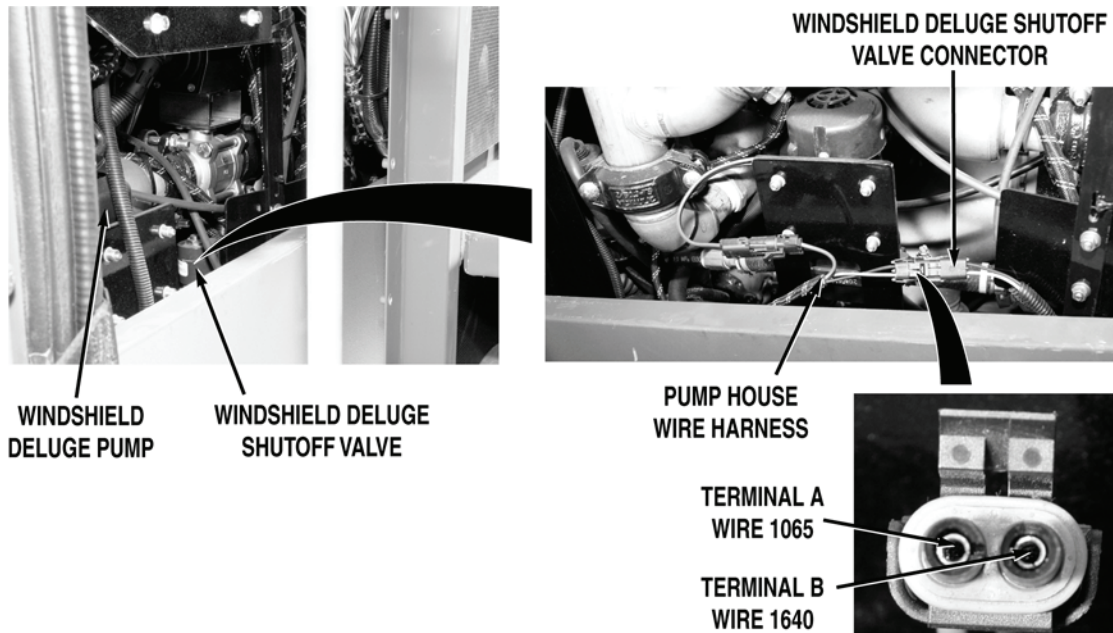
**MALFUNCTION****TEST OR INSPECTION****CORRECTIVE ACTION****WARNING**

**Remove rings, wristwatches, neck chains, and any other jewelry before working around vehicle. Jewelry can catch on equipment and cause serious injury. Jewelry and tools may short across electrical circuits and cause damage to equipment, or severe burns or electrical shock to personnel.**

- Step 8. Put WINDSHIELD DELUGE switch to off position (WP 0004). Connect hose to windshield deluge pump inlet (WP 0432). Disconnect pump house wire harness windshield deluge shutoff valve connector. Put WINDSHIELD DELUGE switch to on position (WP 0004). With a test lead set, check for 22 to 28 VDC between pump house wire harness wire 1065 (pink) at windshield deluge shutoff valve connector, terminal A and a known good ground.

If 22 to 28 VDC are not present, repair wire 1065 in pump house wire harness if repairable (TM 9-2320-325-14&P), or replace pump house wire harness (WP 0458).

- Step 9. Put WINDSHIELD DELUGE switch to off position (WP 0004). Turn battery disconnect switch to OFF position (WP 0007). With a test lead set, check for continuity across pump house wire harness wire 1640 (black) from windshield deluge shutoff valve connector, terminal B and a known good ground.

If there is no continuity, repair wire 1640 in pump house harness if repairable (TM 9-2320-325-14&P), or replace pump house wire harness (WP 0458).

---

**MALFUNCTION****TEST OR INSPECTION****CORRECTIVE ACTION**

---

**NOTE**

Water tank must be drained before removing windshield deluge shutoff valve strainer screen. Water will be discharged from water tank uncontrolled, when windshield deluge valve strainer is removed.

- Step 10. Remove windshield deluge shutoff valve strainer screen (WP 0561). Check if strainer screen is clogged.
- a. If strainer screen is clogged, clean or replace strainer screen (WP 0561).
  - b. If strainer screen is not clogged, replace windshield deluge shutoff valve (WP 0582).

## MALFUNCTION

## TEST OR INSPECTION

## CORRECTIVE ACTION

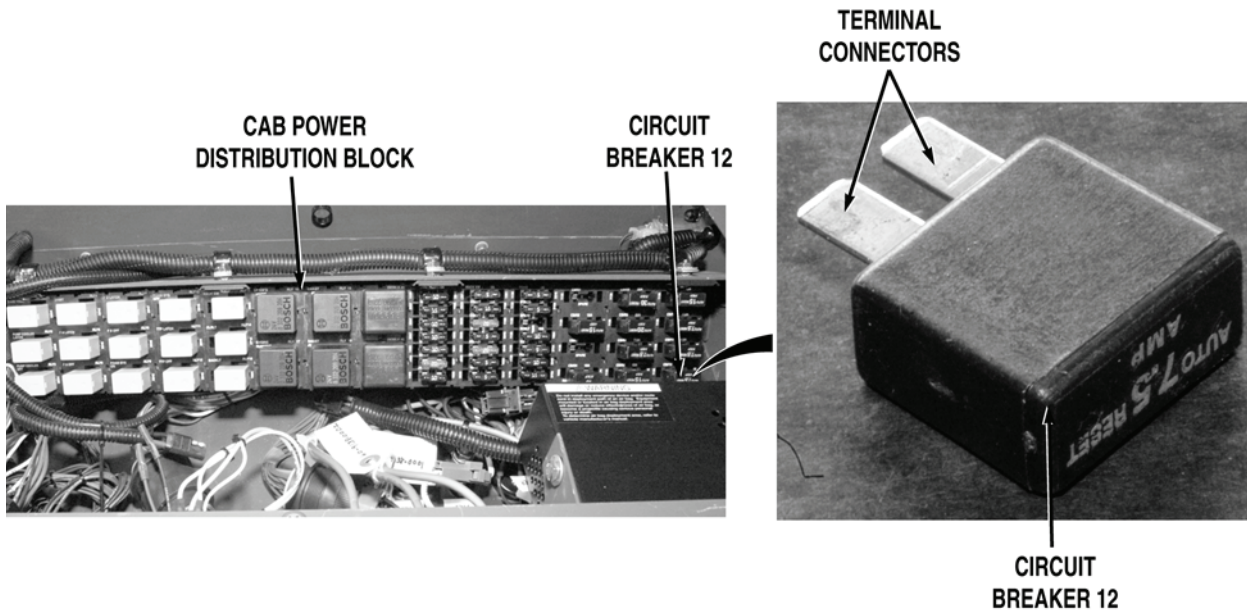
**WARNING**

**Remove rings, wristwatches, neck chains, and any other jewelry before working around vehicle. Jewelry can catch on equipment and cause serious injury. Jewelry and tools may short across electrical circuits and cause damage to equipment, or severe burns or electrical shock to personnel.**

- Step 11. Put WINDSHIELD DELUGE switch to off position (WP 0004). Turn battery disconnect switch to OFF position (WP 0007). Remove personnel cab instrument panel A (WP 0311). Remove circuit breaker 12 (WP 0398). Check for continuity across circuit breaker.

If there is no continuity, replace circuit breaker 12 (WP 0398).

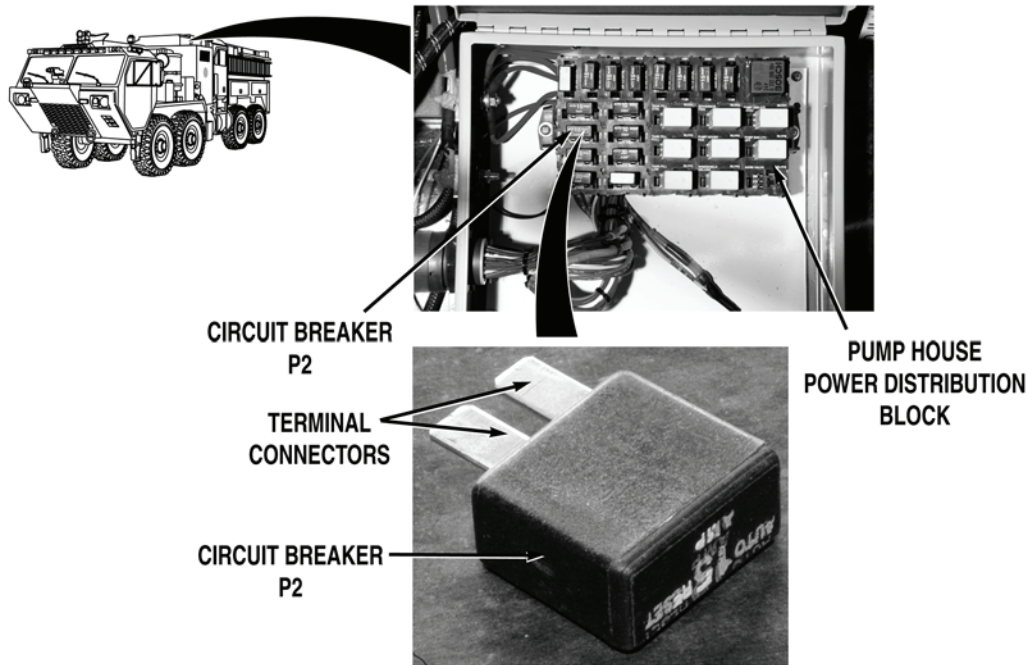

**MALFUNCTION****TEST OR INSPECTION****CORRECTIVE ACTION**

Step 12. Install circuit breaker 12 (WP 0398). Remove pump house panel S (WP 0540). Open pump house power distribution box (WP 0412). Remove circuit breaker P2 (WP 0412). Check for continuity across circuit breaker.

If there is no continuity, replace circuit breaker P2 (WP 0412).

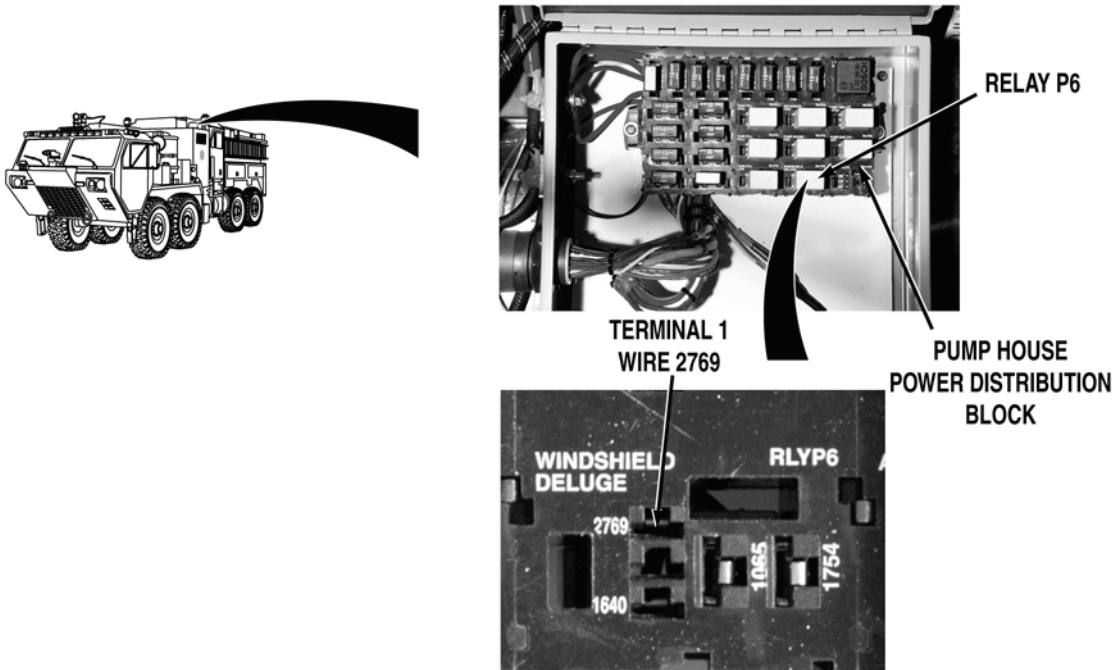
**MALFUNCTION****TEST OR INSPECTION****CORRECTIVE ACTION**

- Step 13. Remove relay P6 from pump house power distribution block (WP 0413). Turn battery disconnect switch to ON position (WP 0007). Put WINDSHIELD DELUGE switch to on position (WP 0004). Check for 22 to 28 VDC between wire 2769 (red) at pump house power distribution block relay P6, terminal 1 and a known good ground.

If 22 to 28 VDC are not present, go to Step 21.

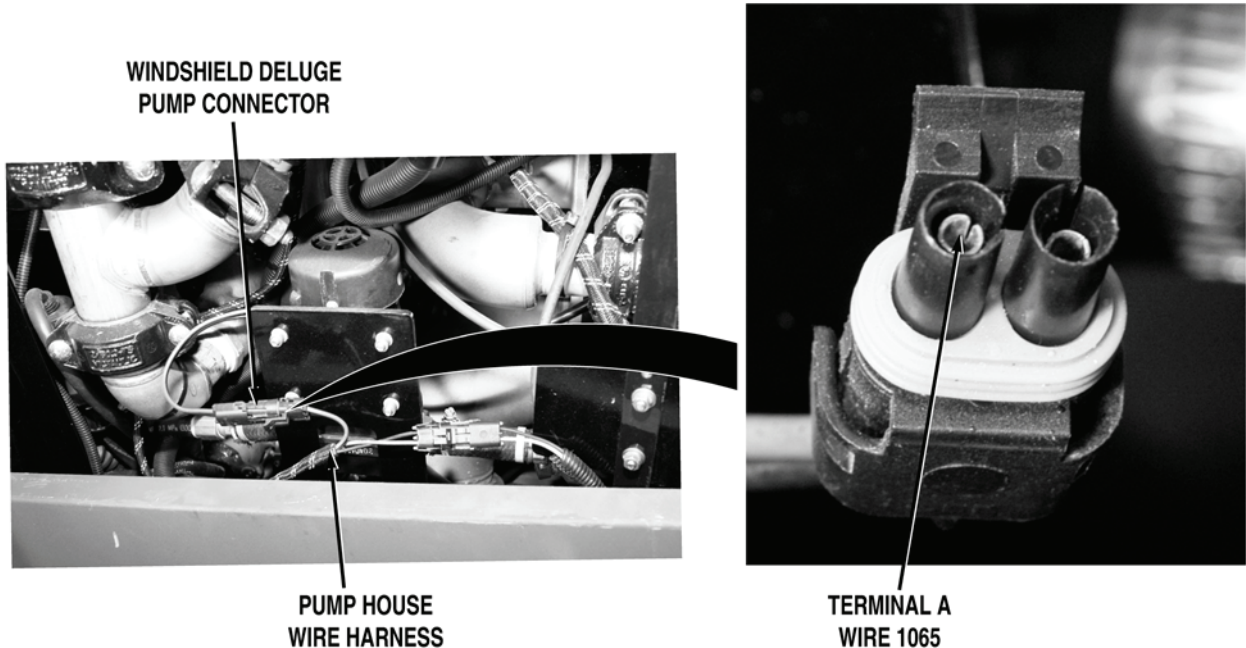
**MALFUNCTION****TEST OR INSPECTION****CORRECTIVE ACTION****WARNING**

**Remove rings, wristwatches, neck chains, and any other jewelry before working around vehicle. Jewelry can catch on equipment and cause serious injury. Jewelry and tools may short across electrical circuits and cause damage to equipment, or severe burns or electrical shock to personnel.**

- Step 14. Turn battery disconnect switch to OFF position (WP 0007). Put WINDSHIELD DELUGE switch to off position (WP 0004). Remove driver side crew cab access panel (WP 0499). Remove pump house panel Q (WP 0540). Install relay P6 (WP 0413). Disconnect pump house wire harness windshield deluge pump connector. Turn battery disconnect switch to ON position (WP 0007). Put WINDSHIELD DELUGE switch to on position (WP 0004). With a test lead set, check for 22 to 28 VDC between pump house wire harness wire 1065 (pink) at windshield deluge pump connector, terminal A and a known good ground.

If 22 to 28 VDC are not present, go to Step 16.

---

**MALFUNCTION****TEST OR INSPECTION****CORRECTIVE ACTION**

---

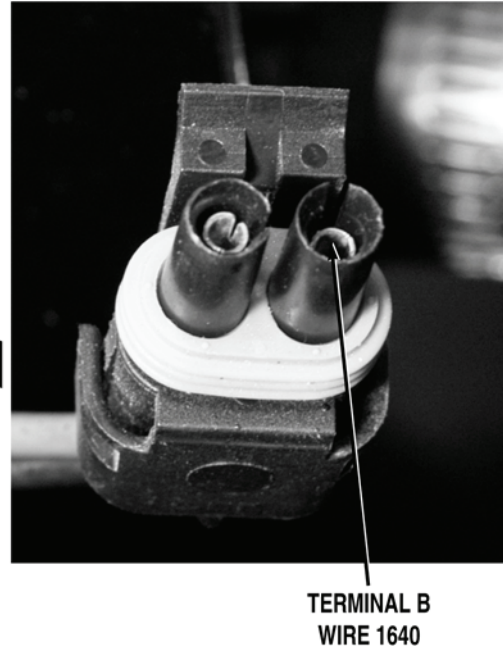
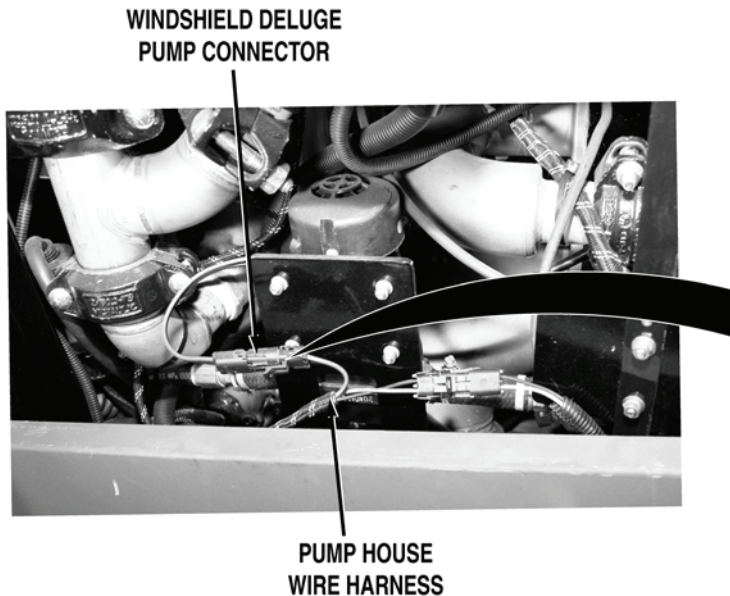

- Step 15. Put WINDSHIELD DELUGE switch to off position (WP 0004). Turn battery disconnect switch to OFF position (WP 0007). With a test lead set, check for continuity across pump house wire harness wire 1640 (black) from windshield deluge pump connector, terminal B to a known good ground.
- a. If there is no continuity, repair wire 1640 in pump house wire harness if repairable (TM 9-2320-325-14&P), or replace pump house wire harness (WP 0458).
  - b. If there is continuity, replace windshield deluge pump (WP 0432).

**MALFUNCTION**  
**TEST OR INSPECTION**  
**CORRECTIVE ACTION**

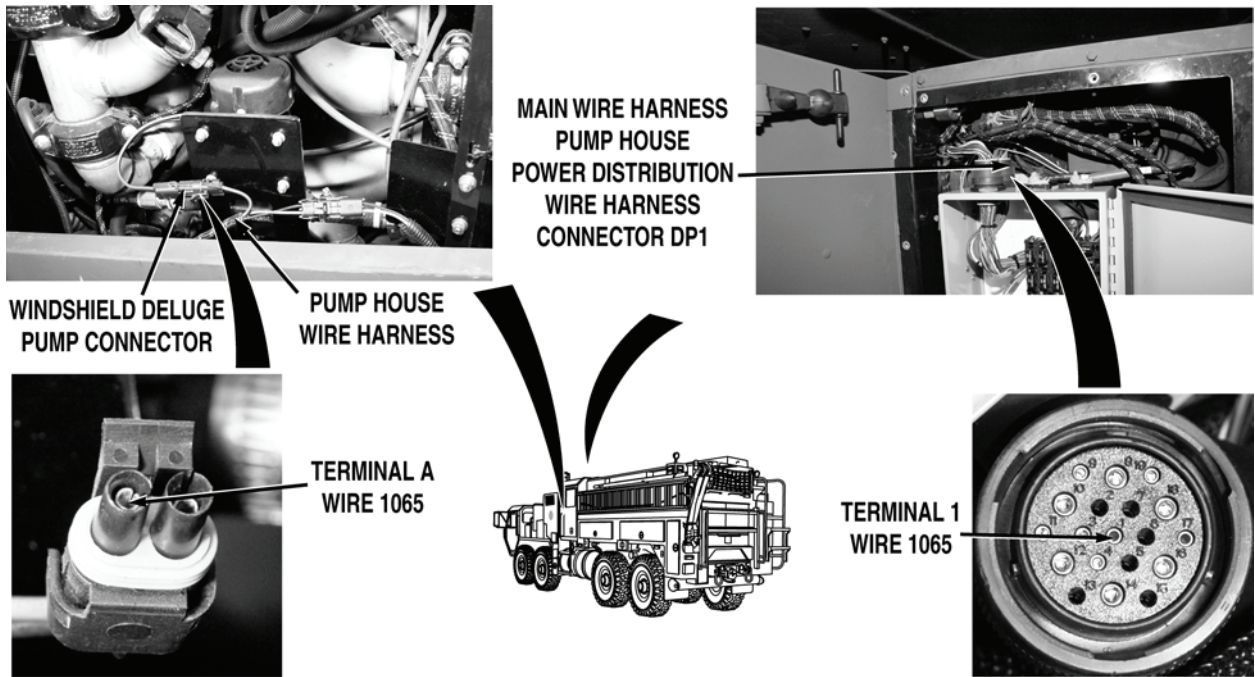

Step 16. Put WINDSHIELD DELUGE switch to off position (WP 0004). Turn battery disconnect switch to OFF position (WP 0007). Disconnect main wire harness pump house power distribution wire harness connector DP1. With a test lead set, check for continuity across wire 1065 (pink) from main wire harness connector DP1, terminal 1 to pump house wire harness windshield deluge pump connector, terminal A.

If there is no continuity, go to Step 20.

## MALFUNCTION

## TEST OR INSPECTION

## CORRECTIVE ACTION

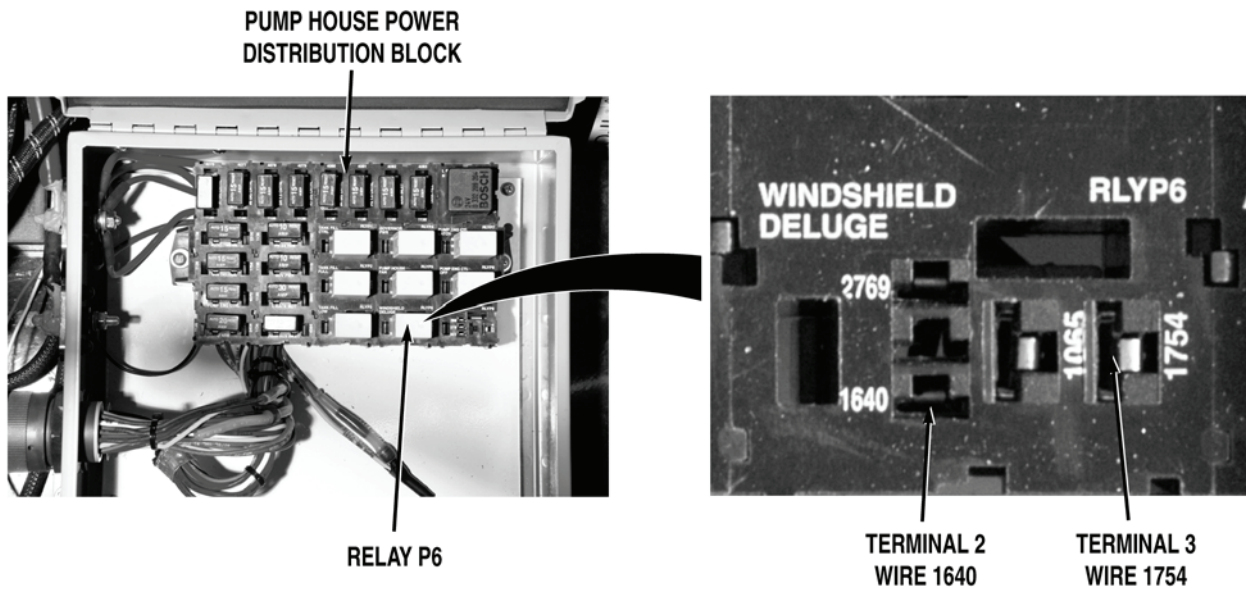
**WARNING**

Remove rings, wristwatches, neck chains, and any other jewelry before working around vehicle. Jewelry can catch on equipment and cause serious injury. Jewelry and tools may short across electrical circuits and cause damage to equipment, or severe burns or electrical shock to personnel.

- Step 17. Connect pump house wire harness windshield deluge pump connector. Connect main wire harness pump house power distribution wire harness connector DP1. Remove relay P6 from pump house power distribution block (WP 0413). Turn battery disconnect switch to ON position (WP 0007). Check for 22 to 28 VDC between pump house power distribution wire harness wire 1754 (red) at relay P6 connector, terminal 3 and a known good ground.

If 22 to 28 VDC are not present, replace pump house power distribution wire harness and block (WP 0457).

- Step 18. Put WINDSHIELD DELUGE switch to off position (WP 0004). Turn battery disconnect switch to OFF position (WP 0007). Check for continuity across pump house power distribution wire harness wire 1640 (black) from relay P6 connector, terminal 2 to a known good ground.

If there is no continuity, repair wire 1640 in pump house power distribution wire harness if repairable (TM 9-2320-325-14&P), or replace pump house power distribution wire harness and block (WP 0457).

## MALFUNCTION

## TEST OR INSPECTION

## CORRECTIVE ACTION

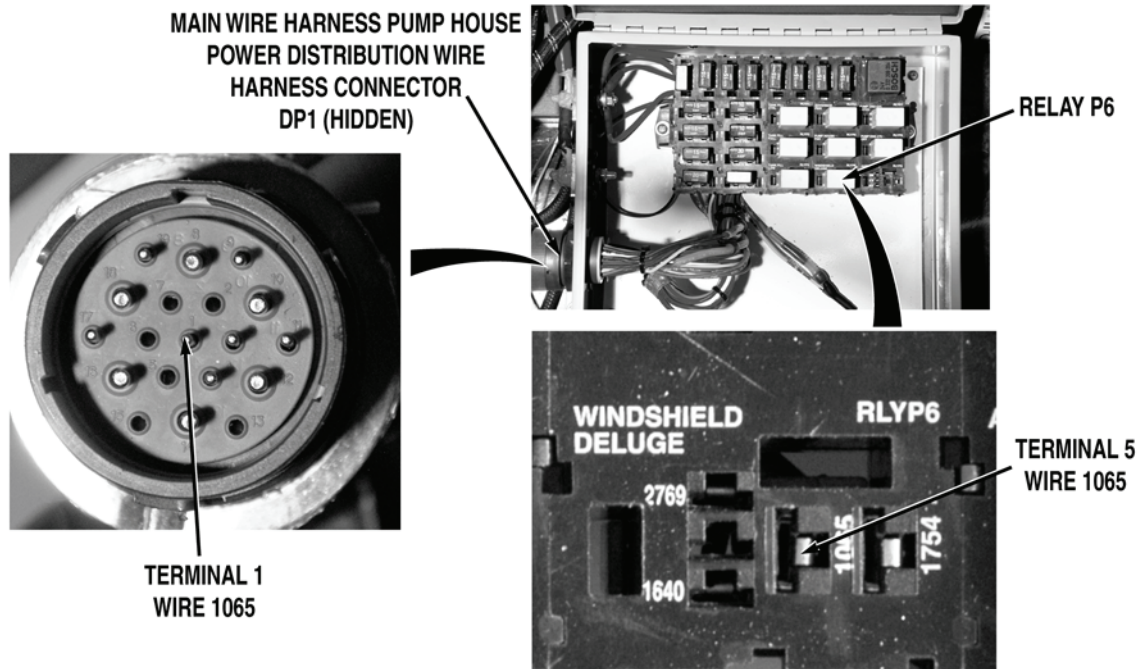

- Step 19. Disconnect main wire harness pump house power distribution wire harness connector DP1. With a test lead set, check for continuity across pump house power distribution wire harness wire 1065 (pink) from relay P6 connector, terminal 5 to pump house power distribution wire harness connector DP1, terminal 1.
- a. If there is continuity, replace relay P6 (WP 0413).
  - b. If there is no continuity, repair wire 1065 in pump house power distribution wire harness if repairable (TM 9-2320-325-14&P), or replace pump house power distribution wire harness and block (WP 0457).

## MALFUNCTION

## TEST OR INSPECTION

## CORRECTIVE ACTION

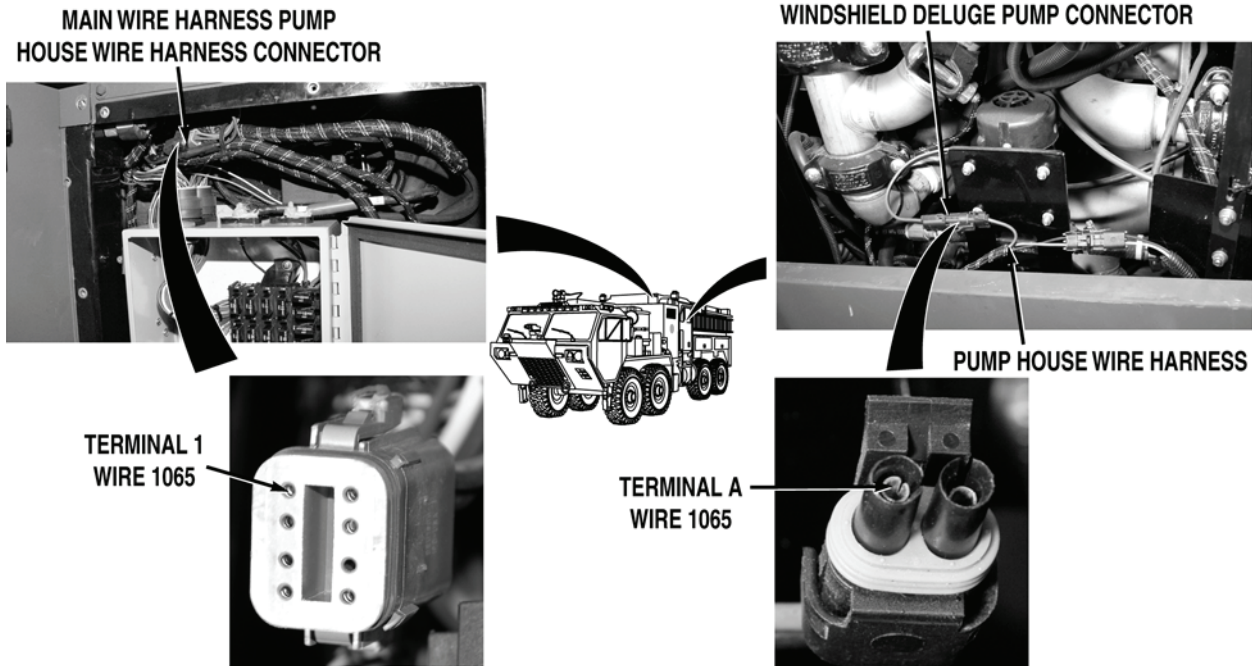
**WARNING**

Remove rings, wristwatches, neck chains, and any other jewelry before working around vehicle. Jewelry can catch on equipment and cause serious injury. Jewelry and tools may short across electrical circuits and cause damage to equipment, or severe burns or electrical shock to personnel.

- Step 20. Disconnect main wire harness pump house wire harness connector. With a test lead set, check for continuity across pump house wire harness wire 1065 (pink) from pump house wire harness connector, terminal A to main wire harness pump house wire harness connector, terminal 1.
- a. If there is continuity, repair wire 1065 in main wire harness if repairable (TM 9-2320-325-14&P), or replace main wire harness (WP 0455).
  - b. If there is no continuity, repair wire 1065 in pump house wire harness if repairable (TM 9-2320-325-14&P), or replace pump house wire harness (WP 0458).



**MALFUNCTION**

**TEST OR INSPECTION**

**CORRECTIVE ACTION**



**WINDSHIELD DELUGE SWITCH**

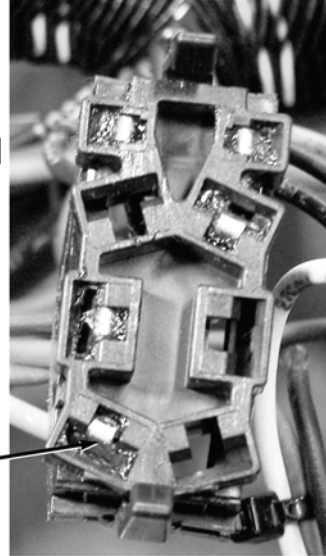

**TERMINAL 6  
WIRE 2343**

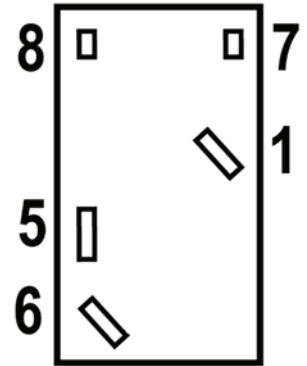

**WARNING**



**Remove rings, wristwatches, neck chains, and any other jewelry before working around vehicle. Jewelry can catch on equipment and cause serious injury. Jewelry and tools may short across electrical circuits and cause damage to equipment, or severe burns or electrical shock to personnel.**

- Step 21. Turn battery disconnect switch to OFF position (WP 0007). Remove personnel cab instrument panel B (WP 0311). Disconnect cab pump control wire harness WINDSHIELD DELUGE switch connector. Turn battery disconnect switch to ON position (WP 0007). Check for 22 to 28 VDC between cab pump control wire harness wire 2343 (red) at WINDSHIELD DELUGE switch connector, terminal 6 and a known good ground.

If 22 to 28 VDC are not present, go to Step 25.

---

**MALFUNCTION****TEST OR INSPECTION****CORRECTIVE ACTION**

---

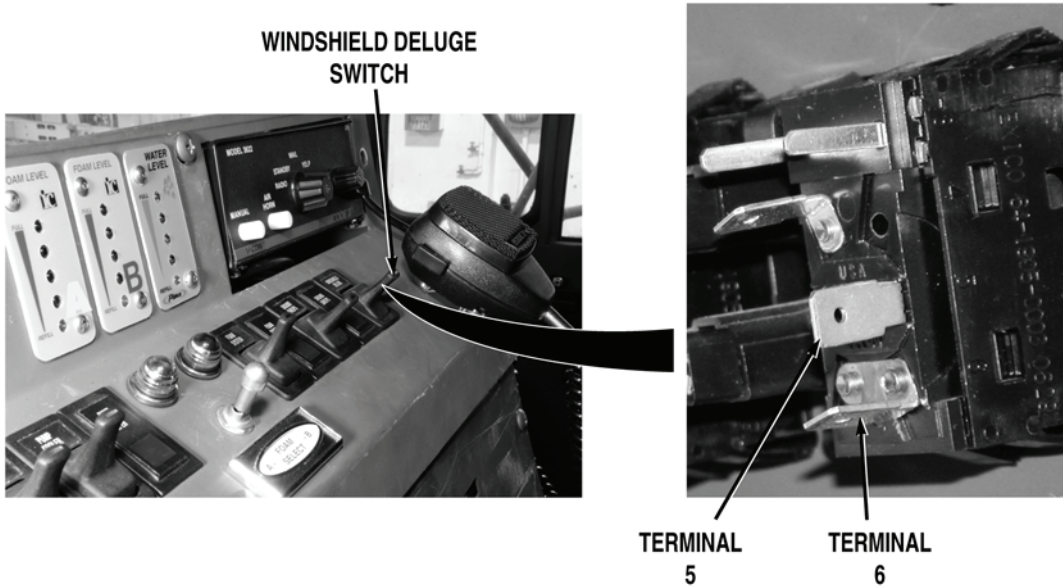

- Step 22. Turn battery disconnect switch to OFF position (WP 0007). Check for continuity across WINDSHIELD DELUGE switch, from terminal 5 to terminal 6, when switch is put to on position.

If there is no continuity, replace WINDSHIELD DELUGE toggle switch (WP 0315).

---

**MALFUNCTION**  
**TEST OR INSPECTION**  
**CORRECTIVE ACTION**

---

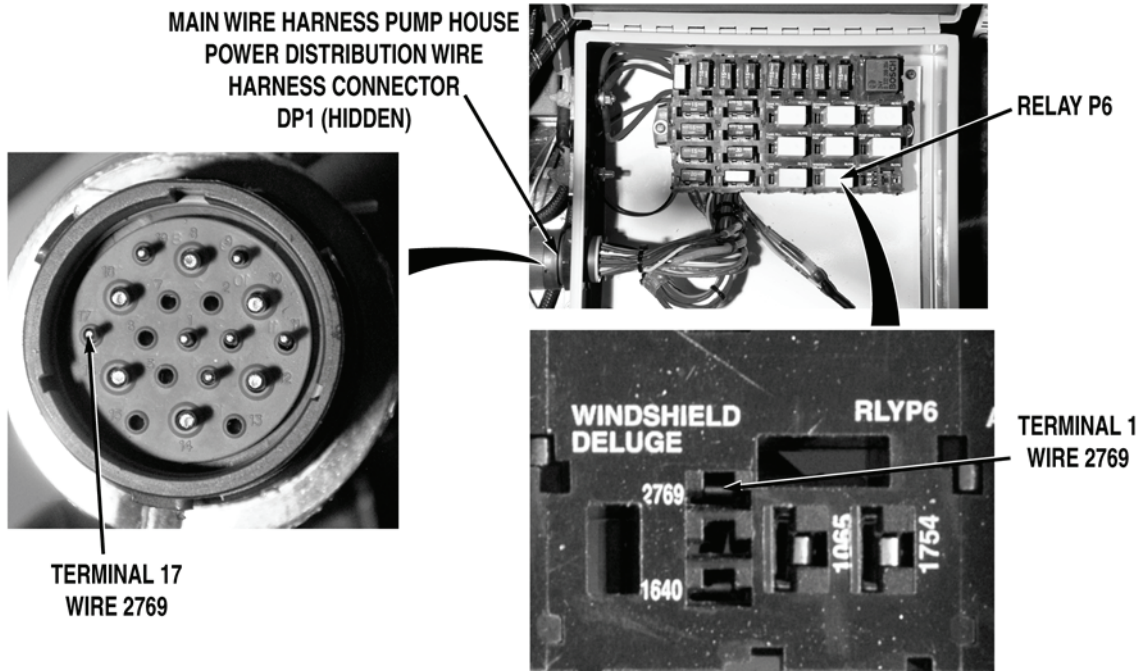

- Step 23. Disconnect main wire harness pump house power distribution wire harness connector DP1. With a test lead set, check for continuity across pump house power distribution wire harness wire 2769 (red) from pump house power distribution wire harness connector DP1, terminal 17 to pump house power distribution block relay P6, terminal 1.

If there is no continuity repair wire 2769 in pump house power distribution wire harness if repairable (TM 9-2320-325-14&P), or replace pump house power distribution wire harness and block (WP 0457).

**MALFUNCTION**

**TEST OR INSPECTION**

**CORRECTIVE ACTION**

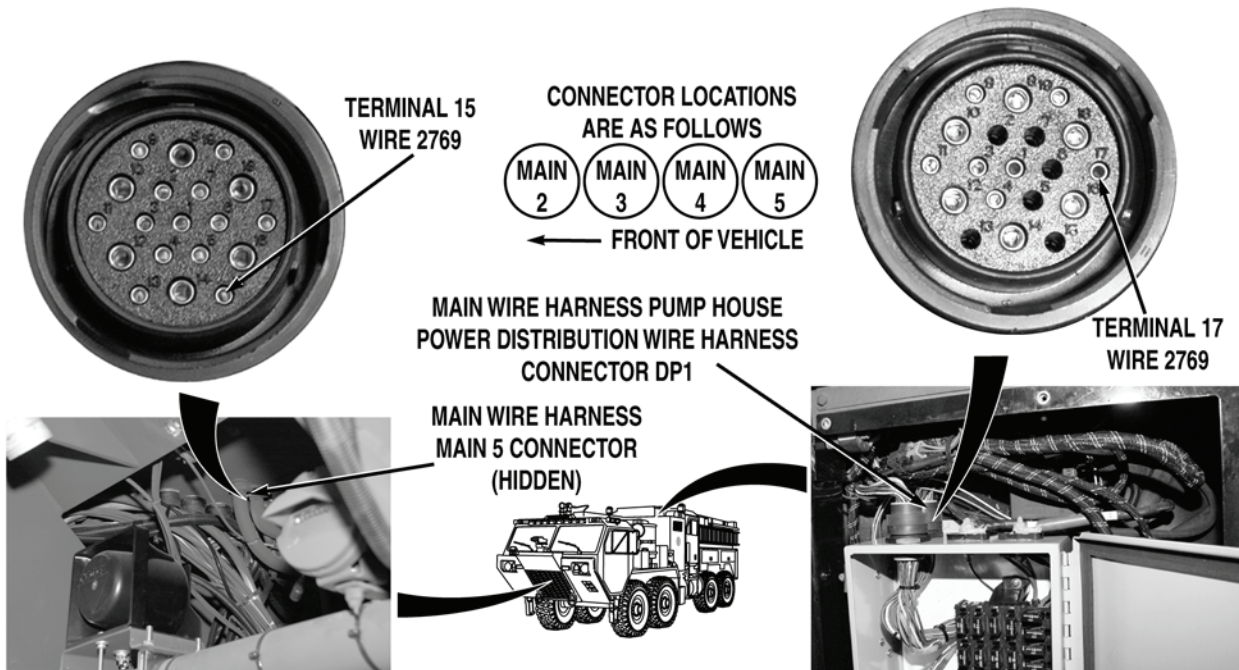

- Step 24. Remove skid plate grille (WP 0550). Disconnect main wire harness main 5 connector. With a test lead set, check for continuity across main wire harness wire 2769 (red) from main wire harness main 5 connector, terminal 15, to main wire harness pump house power distribution wire harness connector DP1, terminal 17.
- a. If there is continuity, repair wire 2769 in cab pump control wire harness if repairable (TM 9-2320-325-14&P), or replace cab pump control wire harness (WP 0443).
  - b. If there is no continuity, repair wire 2769 in main wire harness if repairable (TM 9-2320-325-14&P), or replace main wire harness (WP 0455).

## MALFUNCTION

## TEST OR INSPECTION

## CORRECTIVE ACTION

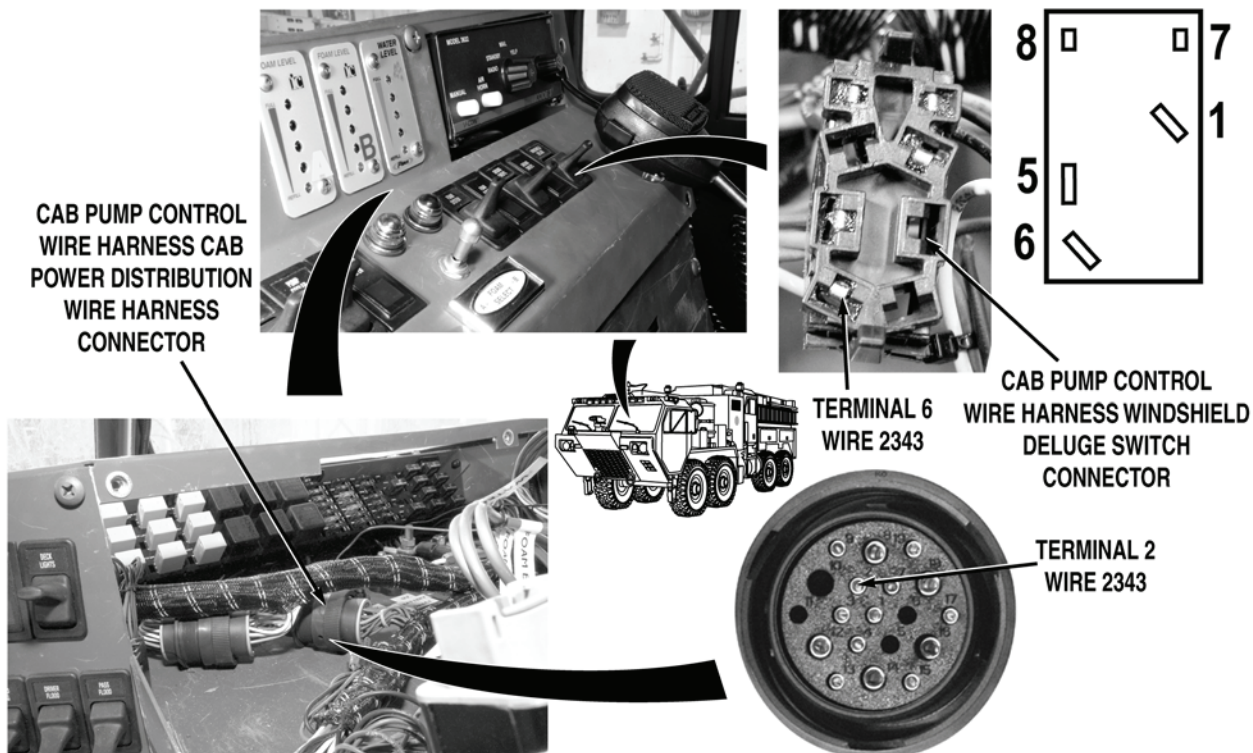
**WARNING**

Remove rings, wristwatches, neck chains, and any other jewelry before working around vehicle. Jewelry can catch on equipment and cause serious injury. Jewelry and tools may short across electrical circuits and cause damage to equipment, or severe burns or electrical shock to personnel.

- Step 25. Disconnect cab pump control wire harness cab power distribution wire harness connector. With a test lead set, check for continuity across cab pump control wire harness wire 2343 (red) from cab pump control wire harness cab power distribution wire harness connector, terminal 2 to WINDSHIELD DELUGE switch connector, terminal 6.
- a. If there is continuity, repair wire 2343 in cab power distribution wire harness if repairable (TM 9-2320-325-14&P), or replace cab power distribution wire harness and block (WP 0441).
  - b. If there is no continuity, repair wire 2343 in cab pump control wire harness if repairable (TM 9-2320-325-14&P), or replace cab pump control wire harness (WP 0443).

END OF TASK

**FOLLOW-ON MAINTENANCE**

Remove wheel chocks (TM 9-2320-347-10)

**END OF TASK**

**END OF WORK PACKAGE**

## ALPHABETICAL INDEX

**Subject**

**WP Sequence No.-Page No.**

### Numerics

120 VAC Outlet(s) Does Not Operate .....	WP 0051-1
120-Volt Air Compressor	
Installation .....	WP 0358-3
Removal .....	WP 0358-1
120-Volt Air Compressor Does Not Operate Properly .....	WP 0163-1
120-Volt Circuit Breaker	
Installation .....	WP 0360-3
Removal .....	WP 0360-1
120-Volt Cord Reel Receptacles Do Not Operate .....	WP 0165-1
120-Volt Power Cord(s)	
Replacement .....	WP 0361-1
120-Volt Receptacle	
Pump Panel B Receptacle Removal .....	WP 0362-3
Pump Panel Receptacle Installation .....	WP 0362-5
Rear Body Panel Receptacles Installation .....	WP 0362-2
Rear Body Panel Receptacles Removal .....	WP 0362-1
120-Volt Receptacles Do Not Operate .....	WP 0164-1
12-Volt Flashlight Charger(s) Does Not Operate .....	WP 0162-1
12-Volt Handheld Radio Battery Charger(s) Does Not Operate (Crew Cab) .....	WP 0161-1
12-Volt Handheld Radio Battery Charger(s) Does Not Operate (Personnel Cab) .....	WP 0160-1
24-Volt Battery Charger	
Installation .....	WP 0359-3
Removal .....	WP 0359-1
24-Volt Battery Charger Does Not Operate	
Field Level .....	WP 0166-1
Operator Level .....	WP 0052-1

### A

Additional Authorization List (AAL) .....	WP 0624-1
Air Conditioner Controller Wire Harness	
Installation .....	WP 0433-7
Removal .....	WP 0433-1
Air Conditioner Electric Motor Wire Harness	
Installation .....	WP 0434-6
Removal .....	WP 0434-1
Air Conditioner Rear Wire Harness	
Installation .....	WP 0435-6
Removal .....	WP 0435-1
Air Lift Bag Storage Box	
Center Air Lift Bag Stowage Box Installation .....	WP 0497-4
Center Air Lift Bag Stowage Box Removal .....	WP 0497-4
Front Air Lift Bag Stowage Box Installation .....	WP 0497-3
Front Air Lift Bag Stowage Box Removal .....	WP 0497-2
Rear Air Lift Bag Stowage Box Installation .....	WP 0497-6
Rear Air Lift Bag Stowage Box Removal .....	WP 0497-5

## ALPHABETICAL INDEX (CONTINUED)

<u>Subject</u>	<u>WP Sequence No.-Page No.</u>
Air Lines and Fittings	
Air Hose Fittings Replacement .....	WP 0567-1
Air Hose Replacement .....	WP 0567-3
Air Reservoir	
Installation .....	WP 0218-4
Removal .....	WP 0218-1
Air Vent Guard	
Installation .....	WP 0498-2
Removal .....	WP 0498-1
Audio Alarm	
Installation .....	WP 0319-2
Removal .....	WP 0319-1
Auto Fill Control	
Installation .....	WP 0363-3
Removal .....	WP 0363-1
Auxiliary Inlet Valve (Passenger Side)	
Installation .....	WP 0294-3
Removal .....	WP 0294-1
Auxiliary Intake Relief/Dump Valve (Passenger Side)	
Installation .....	WP 0256-2
Removal .....	WP 0256-1

### B

Batteries	
Connect Batteries .....	WP 0007-1
Disconnect Batteries .....	WP 0007-1
Batteries, Terminal, and Cable	
Installation .....	WP 0368-5
Removal .....	WP 0368-1
Battery Box and Bracket	
Installation .....	WP 0364-4
Removal .....	WP 0364-1
Battery Charger(s) Receptacle	
Installation .....	WP 0365-4
Removal .....	WP 0365-1
Battery Disconnect Switch and Box	
Installation .....	WP 0366-3
Removal .....	WP 0366-1
Battery Equalizer	
Installation .....	WP 0367-2
Removal .....	WP 0367-1
Battery Equalizer Does Not Operate Properly .....	WP 0167-1
Blackout Relay	
Installation .....	WP 0369-2
Removal .....	WP 0369-1



## ALPHABETICAL INDEX (CONTINUED)

<u>Subject</u>	<u>WP Sequence No.-Page No.</u>
Body Air Condenser Wire Harness	
Installation .....	WP 0436-10
Removal .....	WP 0436-2
Bumper and Roof Turret Manifold Block	
Installation .....	WP 0568-2
Removal .....	WP 0568-1
Bumper Turret	
Assembly .....	WP 0571-5
Bumper Turret Nozzle Speed Adjustment .....	WP 0188-4
Bumper Turret Vertical Speed Adjustment .....	WP 0188-1
Disassembly .....	WP 0571-2
Installation .....	WP 0569-2
Removal .....	WP 0569-1
Bumper Turret and Bumper Turret Nozzle Speed Adjustment	
Bumper Turret Nozzle Speed Adjustment .....	WP 0188-4
Bumper turret vertical speed adjustment .....	WP 0188-1
Bumper Turret and Pump Cooler Dump-To-Ground Control Valve	
Installation .....	WP 0370-4
Removal .....	WP 0370-1
Bumper Turret Auto Drain Valve	
Installation .....	WP 0269-2
Removal .....	WP 0269-1
Bumper Turret Control	
Installation .....	WP 0570-7
Removal .....	WP 0570-1
Bumper Turret Does Not Operate Properly When Selected .....	WP 0104-1
Bumper Turret Junction Box	
Assembly .....	WP 0573-3
Disassembly .....	WP 0573-1
Installation .....	WP 0572-4
Removal .....	WP 0572-1
Bumper Turret Operation .....	WP 0035-1
Bumper Turret Valve	
Installation .....	WP 0482-4
Removal .....	WP 0482-1
Bumper Turret Wire Harness	
Installation .....	WP 0437-3
Removal .....	WP 0437-1

### C

Cab Discharge Digital Pressure Gauge Wire Harness	
Installation .....	WP 0438-2
Removal .....	WP 0438-1
Cab Foam A and Foam B Tank Level Indicator Wire Harness	
Installation .....	WP 0439-2
Removal .....	WP 0439-1

## ALPHABETICAL INDEX (CONTINUED)

<u>Subject</u>	<u>WP Sequence No.-Page No.</u>
Cab Instrument Panel Wire Harness	
Installation .....	WP 0440-7
Removal .....	WP 0440-1
Cab Power Distribution Wire Harness and Block	
Installation .....	WP 0441-6
Removal .....	WP 0441-1
Cab Pump Control Wire Harness	
Installation .....	WP 0443-8
Removal .....	WP 0443-1
Cab Roof Lightbar Cable Assembly	
Installation .....	WP 0371-4
Removal .....	WP 0371-1
Cab Roof Lightbar Cable Assembly Branch	
Installation .....	WP 0372-3
Removal .....	WP 0372-1
Cab Roof Wire Harness	
Installation .....	WP 0442-4
Removal .....	WP 0442-2
Cab Switch Backlighting Does Not Operate .....	WP 0126-1
Cab Water Tank Level Indicator Wire Harness	
Installation .....	WP 0444-2
Removal .....	WP 0444-1
Check Pump Engine Light Comes On .....	WP 0053-1
Circuit Breaker Box	
Installation .....	WP 0373-3
Removal .....	WP 0373-1
Clearance and/or Directional Light(s) Does Not Operate .....	WP 0168-1
Compartment Door(s) .....	WP 0010-1
Close .....	WP 0010-2
Open .....	WP 0010-1
Compartment Light	
Installation .....	WP 0374-2
Removal .....	WP 0374-1
Components of End Item (COEI) and Basic Issue Items (BII) .....	WP 0623-1
Control Valve	
Installation .....	WP 0375-2
Removal .....	WP 0375-1
Cord Reel	
Assembly .....	WP 0376-4
Disassembly .....	WP 0376-2
Installation .....	WP 0381-4
Removal .....	WP 0381-1
Starting Cord Reel Operation .....	WP 0037-1
Stopping Cord Reel Operation .....	WP 0037-2
Cord Reel Cable Work Light Bracket	
Installation .....	WP 0379-2
Removal .....	WP 0379-1

## ALPHABETICAL INDEX (CONTINUED)

<u>Subject</u>	<u>WP Sequence No.-Page No.</u>
Cord Reel Cable Work Light Lamp	
Installation .....	WP 0378-2
Removal .....	WP 0378-1
Cord Reel Cable, Work Light, and Receptacle Box	
Installation .....	WP 0377-3
Removal .....	WP 0377-1
Cord Reel Control Assembly	
Installation .....	WP 0380-2
Removal .....	WP 0380-1
Cord Reel Rewind Circuit Breaker	
Installation .....	WP 0382-3
Removal .....	WP 0382-1
Cord Reel Rewind Control Does Not Operate .....	WP 0169-1
Cord Reel Rewind Solenoid	
Installation .....	WP 0383-3
Removal .....	WP 0383-1
Coupling	
Installation .....	WP 0483-2
Removal .....	WP 0483-1
Cover, Door, and Electronic Mounting Base (SINCGARS)	
Installation .....	WP 0384-2
Removal .....	WP 0384-1
Crew Cab Access Panels	
Installation .....	WP 0499-2
Removal .....	WP 0499-1
Crew Cab Access Steps	
Stow .....	WP 0012-2
Unstow .....	WP 0012-1
Crew Cab Air Conditioner	
Charging .....	WP 0217-11
Evacuation/Recycling .....	WP 0217-4
Flushing .....	WP 0217-9
Purging .....	WP 0217-7
Recovery .....	WP 0217-1
Starting Crew Cab Air Conditioner .....	WP 0008-1
Stopping Crew Cab Air Conditioner .....	WP 0008-1
Crew Cab Air Conditioner Binary Switch	
Installation .....	WP 0197-2
Removal .....	WP 0197-1
Crew Cab Air Conditioner Compressor and Motor Assembly	
Installation .....	WP 0210-5
Removal .....	WP 0210-1
Crew Cab Air Conditioner Compressor Drive Belt	
Adjustment .....	WP 0189-1
Installation .....	WP 0198-2
Removal .....	WP 0198-1
Crew Cab Air Conditioner Compressor Excessively Noisy .....	WP 0071-1

**ALPHABETICAL INDEX (CONTINUED)**

<u>Subject</u>	<u>WP Sequence No.-Page No.</u>
Crew Cab Air Conditioner Condenser	
Installation .....	WP 0211-4
Removal .....	WP 0211-1
Crew Cab Air Conditioner Condenser Fan Assemblies	
Installation .....	WP 0199-2
Removal .....	WP 0199-1
Crew Cab Air Conditioner Does Not Cool or Cools Inadequately .....	WP 0072-1
Crew Cab Air Conditioner Dryer	
Installation .....	WP 0212-2
Removal .....	WP 0212-1
Crew Cab Air Conditioner Evaporator Core	
Installation .....	WP 0214-3
Removal .....	WP 0214-1
Crew Cab Air Conditioner Expansion Valve	
Installation .....	WP 0213-2
Removal .....	WP 0213-1
Crew Cab Air Conditioner Hoses	
Installation .....	WP 0216-2
Removal .....	WP 0216-1
Crew Cab Air Conditioner Thermostatic Switch	
Installation .....	WP 0206-2
Removal .....	WP 0206-1
Crew Cab Air Conditioner/Heater Assembly	
Installation .....	WP 0215-6
Removal .....	WP 0215-1
Crew Cab Air Conditioner/Heater Blower Motor	
Installation .....	WP 0200-5
Removal .....	WP 0200-1
Crew Cab Air Conditioner/Heater Control Box	
Air Conditioner Control Contactor Installation .....	WP 0201-8
Air Conditioner Control Contactor Removal .....	WP 0201-8
Air Conditioner/Heater Control Box Installation .....	WP 0201-11
Air Conditioner/Heater Control Box Removal .....	WP 0201-10
Air Conditioner/Heater Relay Module Block Installation .....	WP 0201-5
Air Conditioner/Heater Relay Module Block Removal .....	WP 0201-5
Air Conditioning Relay Module Block Installation .....	WP 0201-4
Air Conditioning Relay Module Block Removal .....	WP 0201-4
Circuit Breaker Installation .....	WP 0201-9
Circuit Breaker Removal .....	WP 0201-9
Clutch Timer Installation .....	WP 0201-3
Clutch Timer Removal .....	WP 0201-3
Control Box Access .....	WP 0201-1
Control Box Closure .....	WP 0201-13
Delay Timer Installation .....	WP 0201-2
Delay Timer Removal .....	WP 0201-2
Motor Contactor Installation .....	WP 0201-7
Motor Contactor Removal .....	WP 0201-7
Motor Overload Contactor Installation .....	WP 0201-6
Motor Overload Contactor Removal .....	WP 0201-6

## ALPHABETICAL INDEX (CONTINUED)

<u>Subject</u>	<u>WP Sequence No.-Page No.</u>
Crew Cab Air Conditioner/Heater Control Panel	
Installation .....	WP 0202-4
Removal .....	WP 0202-1
Crew Cab Air Conditioner/Heater Control Panel Set Point Programming .....	WP 0009-1
Crew Cab Air Conditioner/Heater Does Not Operate Properly .....	WP 0070-1
Crew Cab Air Conditioner/Heater Fresh Air Fan and Filter	
Installation .....	WP 0203-3
Removal .....	WP 0203-1
Crew Cab Air Conditioner/Heater Fresh Air Resistor	
Installation .....	WP 0204-2
Removal .....	WP 0204-1
Crew Cab Air Conditioner/Heater Louvers	
Installation .....	WP 0205-2
Removal .....	WP 0205-1
Crew Cab Air Conditioning Does Not Operate Properly .....	WP 0054-1
Crew Cab Assembly	
Installation .....	WP 0500-11
Removal .....	WP 0500-1
Crew Cab Bench Seat and Access Panel	
Installation .....	WP 0501-2
Removal .....	WP 0501-1
Crew Cab Dome Light Does Not Operate .....	WP 0159-1
Crew Cab Door Handle	
Inner Door Handle Installation .....	WP 0503-3
Inner Door Handle Removal .....	WP 0503-3
Outer Door Handle Installation .....	WP 0503-2
Outer Door Handle Removal .....	WP 0503-1
Crew Cab Door Latch/Linkage	
Installation .....	WP 0504-4
Removal .....	WP 0504-1
Crew Cab Door Seal	
Installation .....	WP 0505-2
Removal .....	WP 0505-1
Crew Cab Door Window/Regulator	
Installation .....	WP 0506-2
Removal .....	WP 0506-1
Crew Cab Door/Door Hinge	
Installation .....	WP 0502-3
Removal .....	WP 0502-1
Crew Cab Door/Door Hinge Adjustment	
Adjustment .....	WP 0190-1
Crew Cab Heater Control Valve	
Installation .....	WP 0207-2
Removal .....	WP 0207-1
Crew Cab Heater Core	
Installation .....	WP 0208-4
Removal .....	WP 0208-1
Crew Cab Heater Does Not Operate Properly .....	WP 0055-1

## ALPHABETICAL INDEX (CONTINUED)

<u>Subject</u>	<u>WP Sequence No.-Page No.</u>
Crew Cab Heater Hoses	
Installation .....	WP 0209-4
Removal .....	WP 0209-1
Crew Cab Inner Door Panel	
Installation .....	WP 0507-2
Removal .....	WP 0507-1
Crew Cab Insulation	
Installation .....	WP 0603-3
Removal .....	WP 0603-1
Crew Cab Intercom Wire Harness	
Installation .....	WP 0445-3
Removal .....	WP 0445-1
Crew Cab Peep Window	
Installation .....	WP 0508-2
Removal .....	WP 0508-1
Crew Cab Rifle Mount(s)	
Crew Cab Door Rifle Mount Installation .....	WP 0509-3
Crew Cab Door Rifle Mount Removal .....	WP 0509-1
Inside Crew Cab Rifle Mount Installation .....	WP 0509-5
Inside Crew Cab Rifle Mount Removal .....	WP 0509-4
Crew Cab Roof Hatch	
Close .....	WP 0018-1
Installation .....	WP 0510-4
Open .....	WP 0018-1
Removal .....	WP 0510-1
Crew Cab Roof Hatch Door Switch Guard	
Installation .....	WP 0511-1
Removal .....	WP 0511-1
Crew Cab SCBA Seat	
Installation .....	WP 0512-3
Removal .....	WP 0512-2
Crew Cab SCBA Seat Repair	
Installation .....	WP 0513-4
Removal .....	WP 0513-1
Crew Cab Vent Window	
Installation .....	WP 0516-2
Removal .....	WP 0516-1
Crew Cab Window	
Installation .....	WP 0515-2
Removal .....	WP 0515-1
Crew Cab Wire Harness	
Installation .....	WP 0446-7
Removal .....	WP 0446-1
Cross Divider	
Installation .....	WP 0517-2
Removal .....	WP 0517-1

## ALPHABETICAL INDEX (CONTINUED)

<u>Subject</u>	<u>WP Sequence No.-Page No.</u>
<b>D</b>	
Decal and Data Plate	
Data Plate Installation .....	WP 0518-4
Data Plate Removal .....	WP 0518-3
Decal Plate Installation .....	WP 0518-2
Decal Plate Removal .....	WP 0518-1
Deck Lights Do Not Operate .....	WP 0157-1
Deck Lights, Crew Cab Dome Lights, Clearance Lights, and Compartment Lights Do Not Operate ...	WP 0056-1
Deck Spotlight	
Installation .....	WP 0352-4
Removal .....	WP 0352-1
Deck Spotlight Lamp	
Installation .....	WP 0353-2
Removal .....	WP 0353-1
Description and Use of Operator's Controls and Indicators	
Controls and Indicators Introduction .....	WP 0004-1
Destruction of Army Materiel To Prevent Enemy Use .....	WP 0001-2
Digital Pressure Gauge(s) Does Not Operate .....	WP 0127-1
Direct Tank Fill AUTO Indicator Does Not Illuminate (Pump Operator's Panel) .....	WP 0128-1
Direct Tank Fill OPEN Indicator Does Not Illuminate (Pump Operator's Panel) .....	WP 0129-1
Direct Tank Fill Valve Does Not Operate Properly (Auto or Manual Mode) .....	WP 0105-1
Direct Tank Fill Valve Wire Harness	
Installation .....	WP 0447-3
Removal .....	WP 0447-1
Discharges Have Abnormal Water Streams .....	WP 0069-1
DO NOT MOVE APPARATUS WHEN LIGHT IS ON Indicator Does Not Operate Properly .....	WP 0130-1
DO NOT MOVE APPARATUS WHEN LIGHT IS ON Indicator Flashes .....	WP 0057-1
Dome Light (LED & Incandescent)	
Installation .....	WP 0357-2
Removal .....	WP 0357-1
Door Switch	
Installation .....	WP 0385-2
Removal .....	WP 0385-1
Drain Valve (Multi-Port)	
Installation .....	WP 0272-4
Removal .....	WP 0272-2
Drain Valve, Driver Pre-Connect A	
Installation .....	WP 0270-3
Removal .....	WP 0270-1
Drain Valve, Driver Pre-Connect B	
Installation .....	WP 0271-3
Removal .....	WP 0271-1
Drain Valves Leaking During Pumping Operations .....	WP 0066-1
Draining Water Tank .....	WP 0029-1
Driver Main Inlet Primer Valve	
Installation .....	WP 0268-4
Removal .....	WP 0268-1

## ALPHABETICAL INDEX (CONTINUED)

<u>Subject</u>	<u>WP Sequence No.-Page No.</u>
Driver Main Inlet Valve Does Not Operate Properly .....	WP 0106-1
Driver Side and Passenger Side Crew Cab Ladder	
Driver Side Crew Cab Ladder Installation .....	WP 0514-2
Driver Side Crew Cab Ladder Removal .....	WP 0514-2
Passenger Side Crew Cab Ladder Installation .....	WP 0514-5
Passenger Side Crew Cab Ladder Removal .....	WP 0514-3
Driver Side Body Wire Harness	
Installation .....	WP 0448-12
Removal .....	WP 0448-2
Driver Side Hose Bed Cover Installation .....	WP 0524-4
Driver Side Pre-Connect A Valve Does Not Operate Properly .....	WP 0107-1
Driver Side Pre-Connect B Valve Does Not Operate Properly .....	WP 0108-1
Driver Side Stowage Compartment Light(s) Does Not Operate .....	WP 0177-1
Dual Governor Pressure Switch	
Installation .....	WP 0386-3
Removal .....	WP 0386-1

### E

Electronically-Operated Ball Valve Electric Motor and Drive Assembly	
Installation .....	WP 0388-2
Removal .....	WP 0388-1
Electronically-Operated Ball Valve Seats and Preformed Packing	
Installation .....	WP 0387-2
Removal .....	WP 0387-1
Equipment (Ladder) Rack	
Installation .....	WP 0519-5
Removal .....	WP 0519-1
Stow .....	WP 0011-2
Unstow .....	WP 0011-1
Equipment (Ladder) Rack Control Assembly	
Installation .....	WP 0389-2
Removal .....	WP 0389-1
Equipment (Ladder) Rack Control Wire Harness	
Installation .....	WP 0449-4
Removal .....	WP 0449-1
Equipment (Ladder) Rack Does Not Operate .....	WP 0131-1
Equipment Description and Data	
Equipment Characteristics, Capabilities, and Features .....	WP 0002-1
Equipment Data .....	WP 0002-8
Location and Description of Major Components .....	WP 0002-6
Evaporator Wire Harness	
Installation .....	WP 0450-4
Removal .....	WP 0450-1
Expendable Supplies and Materials List .....	WP 0625-1
Extendable Floodlight	
Installation .....	WP 0354-3
Removal .....	WP 0354-1



**ALPHABETICAL INDEX (CONTINUED)**

<u>Subject</u>	<u>WP Sequence No.-Page No.</u>
Extendable Floodlight Lamp	
Installation .....	WP 0355-2
Removal .....	WP 0355-1
Extendable Floodlights Do Not Operate .....	WP 0058-1, WP 0158-1

**F**

Flow Sensor	
Installation .....	WP 0390-2
Removal .....	WP 0390-1
Flow Sensor Wire Harness	
Installation .....	WP 0451-3
Removal .....	WP 0451-2
Flush Check Valve	
Installation .....	WP 0280-2
Removal .....	WP 0280-1
Foam A Tank Level Indicator Gauge Does Not Operate Properly .....	WP 0102-1
Foam Agent	
Draining/Flushing Foam Agent Tank .....	WP 0031-3
Filling Foam Agent Tank .....	WP 0031-1
Foam B Tank Level Indicator Gauge Does Not Operate Properly .....	WP 0103-1
Foam Cover and Water Tank Vent	
Installation .....	WP 0574-2
Removal .....	WP 0574-1
FOAM FLUSH Indicator Does Not Illuminate (Pump Operator's Panel) .....	WP 0132-1
Foam Level Probe	
Calibration .....	WP 0191-1
Installation .....	WP 0281-2
Removal .....	WP 0281-1
Foam Not Delivered From All Systems (Bumper Turret, Ground Sweeps, and Manual Metering Controls) or System Does Not Shut Off .....	WP 0094-1
Foam Not Delivered From Bumper Turret .....	WP 0097-1
Foam Not Delivered From Ground Sweeps .....	WP 0099-1
Foam Not Delivered From Roof Turret .....	WP 0098-1
Foam Not Delivered When Manual Metering Control is Operated .....	WP 0100-1
Foam Not Delivered When Tank A is Selected (Bumper Turret, Ground Sweeps, and Manual Metering Controls) .....	WP 0095-1
Foam Not Delivered When Tank B is Selected (Bumper Turret, Under Truck Nozzles, and Manual Metering Controls) .....	WP 0096-1
Foam System	
Draining Foam Tanks .....	WP 0040-7
Flushing Foam Tanks .....	WP 0040-8
Foam Agent Piping Flush Procedure .....	WP 0040-1
Foam System Flushing .....	WP 0040-1
Foam System "A & B" Tank Drain	
Installation .....	WP 0273-2
Removal .....	WP 0273-1

## ALPHABETICAL INDEX (CONTINUED)

<u>Subject</u>	<u>WP Sequence No.-Page No.</u>
Foam System "A" Check Valve	
Installation .....	WP 0282-1
Removal .....	WP 0282-1
Foam System "A" Shutoff Valve	
Installation .....	WP 0284-2
Removal .....	WP 0284-1
Foam System "B" Check Valve	
Installation .....	WP 0283-1
Removal .....	WP 0283-1
Foam System "B" Shutoff Valve	
Installation .....	WP 0285-2
Removal .....	WP 0285-1
Foam System and Instrument Panel-Standby Mode	
Foam System-Standby Mode .....	WP 0032-2
Instrument Panel-Standby Mode .....	WP 0032-1
Foam System Cannot Be Flushed .....	WP 0101-1
Foam System Does Not Operate .....	WP 0060-1
Foam System Eductor	
Installation .....	WP 0286-2
Removal .....	WP 0286-1
Foam System Eductor Valve	
Installation .....	WP 0287-2
Removal .....	WP 0287-1
Foam System Flow Control Manifold	
Installation .....	WP 0288-4
Removal .....	WP 0288-1
Foam System Flush Valve	
Installation .....	WP 0289-2
Removal .....	WP 0289-1
Foam System General Information .....	WP 0030-1
FOAM SYSTEM Indicator Does Not Illuminate (Cab) .....	WP 0133-1
FOAM SYSTEM Indicator Does Not Illuminate (Pump Operator's Panel) .....	WP 0134-1
Foam System Inlet Check Valve	
Installation .....	WP 0290-2
Removal .....	WP 0290-1
Foam System Manual Metering Valve	
Installation .....	WP 0291-2
Removal .....	WP 0291-1
Foam System Multi-Metering Valve (Automatic)	
Installation .....	WP 0292-3
Removal .....	WP 0292-1
Foam System Operating Procedures (Cab Instrument Panel)	
Foam System Activation .....	WP 0034-1
Foam System Deactivation/Clean-Up .....	WP 0034-3
Stopping Foam Solution Flow .....	WP 0034-3

**ALPHABETICAL INDEX (CONTINUED)**

<u>Subject</u>	<u>WP Sequence No.-Page No.</u>
Foam System Operating Procedures (Pump Operator's Panel)	
Foam System Activation .....	WP 0033-1
Foam System Deactivation/Clean-Up .....	WP 0033-4
Starting Foam Solution Flow .....	WP 0033-2
Stopping Foam Solution Flow .....	WP 0033-3
Foam Tank Fill Port Extensions and Covers	
Installation .....	WP 0293-2
Removal .....	WP 0293-1
Foam Tank Level Probe Wire Harness	
Installation .....	WP 0452-2
Removal .....	WP 0452-1
Fuel Tank Brackets	
Installation .....	WP 0564-6
Removal .....	WP 0564-1

**G**

Gasoline Can Stowage Compartment	
Installation .....	WP 0520-2
Removal .....	WP 0520-1
GEN PTO ENGAGE Indicator Does Not Illuminate (Cab) .....	WP 0139-1
General Information	
Corrosion Prevention and Control .....	WP 0001-2
Demolition By Mechanical Means .....	WP 0001-2
Demolition By Misuse .....	WP 0001-2
Destruction Of Army Material To Prevent Enemy Use .....	WP 0001-2
Destruction Of Army Materiel To Prevent Enemy Use .....	WP 0001-2
List of Abbreviations/Acronyms .....	WP 0001-4
List of Warning Icons/Descriptions .....	WP 0001-5
Maintenance Forms, Records, and Reports .....	WP 0001-2
Nomenclature Cross-Reference List .....	WP 0001-3
Quality of Material .....	WP 0001-8
Repair Parts .....	WP 0001-8
Reporting Equipment Improvement Recommendations (EIR) .....	WP 0001-2
Scope .....	WP 0001-1
Warranty Information .....	WP 0001-3
Glow Plug Circuit Breaker	
Installation .....	WP 0391-2
Removal .....	WP 0391-1
Glow Plug Control Relay	
Installation .....	WP 0392-2
Removal .....	WP 0392-1
Grab Handle	
Installation .....	WP 0521-6
Removal .....	WP 0521-1

**ALPHABETICAL INDEX (CONTINUED)**

<u>Subject</u>	<u>WP Sequence No.-Page No.</u>
Ground Sweeps	
Back Ground Sweeps Installation .....	WP 0575-7
Back Ground Sweeps Removal .....	WP 0575-7
Front Ground Sweeps Installation .....	WP 0575-2
Front Ground Sweeps Removal .....	WP 0575-1
Middle Back Ground Sweeps Installation .....	WP 0575-6
Middle Back Ground Sweeps Removal .....	WP 0575-5
Middle Front Ground Sweeps Installation .....	WP 0575-4
Middle Front Ground Sweeps Removal .....	WP 0575-3
Starting Ground Sweeps .....	WP 0039-1
Stopping Ground Sweeps .....	WP 0039-1
Ground Sweeps Do Not Operate When Selected .....	WP 0120-1
GROUND SWEEPS Indicator Does Not Illuminate (Cab) .....	WP 0144-1
Ground Sweeps Valve	
Installation .....	WP 0576-2
Removal .....	WP 0576-1

**H**

Handheld Radio Battery Charger(s) Does Not Charge Batteries .....	WP 0067-1
Heat Trace Junction Box	
Installation .....	WP 0604-4
Removal .....	WP 0604-1
Heat Trace Thermostat	
Installation .....	WP 0605-4
Removal .....	WP 0605-1
Heater Access Panel	
Installation .....	WP 0522-2
Removal .....	WP 0522-1
Heater Fuel Pumps	
Installation .....	WP 0467-2
Removal .....	WP 0467-1
Heater Fuel Tank Pickups	
Installation .....	WP 0468-6
Removal .....	WP 0468-1
High Amperage Cable	
Replacement .....	WP 0393-1
High Pressure Water Source Intake Relief Valve Setting	
Adjustment .....	WP 0257-1
Hose Bed Cover(s)	
Driver Side Hose Bed Cover Installation .....	WP 0524-4
Driver Side Hose Bed Cover Removal .....	WP 0524-2
Passenger Side Hose Bed Cover Installation .....	WP 0524-10
Passenger Side Hose Bed Cover Removal .....	WP 0524-7
Hose Bed Covers	
Close .....	WP 0015-3
Open .....	WP 0015-1

## ALPHABETICAL INDEX (CONTINUED)

<u>Subject</u>	<u>WP Sequence No.-Page No.</u>
Hose Bed Divider	
Installation .....	WP 0525-2
Removal .....	WP 0525-1
Hose Bed Grating	
Installation .....	WP 0526-2
Removal .....	WP 0526-1
Hose Restraint Net	
Installation .....	WP 0523-2
Removal .....	WP 0523-1
Hydraulic Generator	
Installation .....	WP 0592-7
Removal .....	WP 0592-1
Starting Hydraulic Generator .....	WP 0021-1
Stopping Hydraulic Generator .....	WP 0021-2
Hydraulic Generator Cables	
Installation .....	WP 0583-5
Removal .....	WP 0583-1
Hydraulic Generator Compensator	
Adjustment .....	WP 0192-1
Installation .....	WP 0584-2
Removal .....	WP 0584-1
Hydraulic Generator Digital Display Module	
Installation .....	WP 0585-4
Removal .....	WP 0585-1
Hydraulic Generator Does Not Operate Properly .....	WP 0171-1
Hydraulic Generator Hoses	
Hydraulic Coupling Installation .....	WP 0586-3
Hydraulic Coupling Removal .....	WP 0586-1
Hydraulic Lines .....	WP 0586-3
Hydraulic Generator Motor	
Installation .....	WP 0591-4
Removal .....	WP 0591-1
Hydraulic Generator Oil	
Drain .....	WP 0588-1
Fill .....	WP 0588-2
Hydraulic Generator Oil Cooler Fan	
Installation .....	WP 0587-2
Removal .....	WP 0587-1
Hydraulic Generator Oil Cooling Fan Does Not Operate Properly .....	WP 0172-1
Hydraulic Generator Oil Filter	
Installation .....	WP 0589-2
Removal .....	WP 0589-1
Hydraulic Generator Oil Filter Base	
Installation .....	WP 0590-3
Removal .....	WP 0590-1
Hydraulic Generator PTO Does Not Engage When Selected .....	WP 0121-1
Hydraulic Generator Reservoir	
Installation .....	WP 0596-3
Removal .....	WP 0596-1

## ALPHABETICAL INDEX (CONTINUED)

<u>Subject</u>	<u>WP Sequence No.-Page No.</u>
Hydraulic Generator Reservoir Boost Unit Assembly	
Installation .....	WP 0593-2
Removal .....	WP 0593-1
Hydraulic Generator Reservoir Breather	
Installation .....	WP 0594-2
Removal .....	WP 0594-1
Hydraulic Generator Reservoir Fluid Level Gauge	
Installation .....	WP 0595-2
Removal .....	WP 0595-1
Hydraulic Generator Reservoir Strainer	
Installation .....	WP 0597-2
Removal .....	WP 0597-1
Hydraulic Generator Reservoir Temperature Sensor	
Installation .....	WP 0598-2
Removal .....	WP 0598-1
Hydraulic System Bleed .....	WP 0599-1

### I

Illustrated List of Manufactured Items .....	WP 0608-1
Inlet, Discharge, and Tank Fill and Re-Circulating Control Valve Wire Harness	
Installation .....	WP 0453-3
Removal .....	WP 0453-2
Inline Fuse	
Installation .....	WP 0394-1
Removal .....	WP 0394-1
Intercom	
Installation .....	WP 0395-4
Removal .....	WP 0395-1
Intercom and Headsets Do Not Operate Properly .....	WP 0173-1
Intercom Wire Harness	
Installation .....	WP 0454-3
Removal .....	WP 0454-1

### L

Light Bezel	
Installation .....	WP 0396-1
Removal .....	WP 0396-1
Light Bezel Cover	
Installation .....	WP 0397-3
Removal .....	WP 0397-1

## ALPHABETICAL INDEX (CONTINUED)

<u>Subject</u>	<u>WP Sequence No.-Page No.</u>
Loose Equipment (Components of End Item) Mounting Bracket(s)	
Adapter Bracket Installation .....	WP 0527-27
Adapter Bracket Removal .....	WP 0527-27
Air Lifting Kit Bracket Installation .....	WP 0527-22
Air Lifting Kit Bracket Removal .....	WP 0527-21
Arson Handle Bracket Installation .....	WP 0527-24
Arson Handle Bracket Removal .....	WP 0527-24
Axe Handle Bracket Installation .....	WP 0527-11
Axe Handle Bracket Removal .....	WP 0527-11
Axe Protector Bracket Installation .....	WP 0527-12
Axe Protector Bracket Removal .....	WP 0527-12
Base Bracket Installation .....	WP 0527-14
Base Bracket Removal .....	WP 0527-13
Fan Bracket Installation .....	WP 0527-2
Fan Bracket Removal .....	WP 0527-1
Fire Extinguisher Bracket Installation .....	WP 0527-15
Fire Extinguisher Bracket Removal .....	WP 0527-15
Forestry Tool Bracket Installation .....	WP 0527-3
Forestry Tool Bracket Removal .....	WP 0527-3
Hooligan Tool Bracket Installation .....	WP 0527-9
Hooligan Tool Bracket Removal .....	WP 0527-9
Loop Bracket Installation .....	WP 0527-7
Loop Bracket Removal .....	WP 0527-7
Mattock Pick Bracket Installation .....	WP 0527-5
Mattock Pick Bracket Removal .....	WP 0527-5
Millennium Detector Bracket Installation .....	WP 0527-19
Millennium Detector Bracket Removal .....	WP 0527-19
Monitor Package Bracket Installation .....	WP 0527-17
Monitor Package Bracket Removal .....	WP 0527-17
Nozzle Bracket Installation .....	WP 0527-25
Nozzle Bracket Removal .....	WP 0527-25
Nozzle Tip Bracket Installation .....	WP 0527-18
Nozzle Tool Bracket Installation .....	WP 0527-26
Nozzle Tool Bracket Removal .....	WP 0527-26
Pike Handle Bracket Installation .....	WP 0527-23
Pike Handle Bracket Removal .....	WP 0527-23
Pike Pole Bracket Installation .....	WP 0527-20
Pike Pole Bracket Removal .....	WP 0527-20
Pry Axe Attachment Bracket Installation .....	WP 0527-8
Pry Axe Attachment Bracket Removal .....	WP 0527-8
Pry Axe W/Claw Bracket Installation .....	WP 0527-10
Pry Axe W/Claw Bracket Removal .....	WP 0527-10
Pulaski Axe Bracket Installation .....	WP 0527-4
Pulaski Axe Bracket Removal .....	WP 0527-4
Shovel Bracket Removal .....	WP 0527-6
Streamlight Bracket Installation .....	WP 0527-28
Streamlight Bracket Removal .....	WP 0527-28
Y Bracket Installation .....	WP 0527-16
Y Bracket Removal .....	WP 0527-16

## ALPHABETICAL INDEX (CONTINUED)

<u>Subject</u>	<u>WP Sequence No.-Page No.</u>
Lower Rear Marker Light and Bracket	
Installation .....	WP 0342-3
Removal .....	WP 0342-1

### M

Main Inlet Valve (Driver Side)	
Installation .....	WP 0484-3
Removal .....	WP 0484-1
Main Intake Relief/Dump Valve (Driver Side)	
Installation .....	WP 0258-2
Removal .....	WP 0258-1
Main Wire Harness	
Installation .....	WP 0455-19
Removal .....	WP 0455-1
Maintenance Allocation Chart (MAC) .....	WP 0622-1
Maintenance Allocation Chart (MAC) Introduction .....	WP 0621-1
Maintenance General Introduction .....	WP 0187-1
Marker Light (Amber LED)	
Installation .....	WP 0343-2
Removal .....	WP 0343-1

### N

No. 1 Discharge Drain Valve (Driver Side)	
Installation .....	WP 0274-3
Removal .....	WP 0274-1
No. 1 Discharge Valve (Driver Side)	
Installation .....	WP 0485-4
Removal .....	WP 0485-2
No. 1 Discharge Valve (Driver Side) Does Not Operate Properly .....	WP 0109-1
No. 2 Discharge Drain Valve (Driver Side)	
Installation .....	WP 0275-3
Removal .....	WP 0275-1
No. 2 Discharge Valve (Driver Side)	
Installation .....	WP 0486-3
Removal .....	WP 0486-1
No. 2 Discharge Valve (Driver Side) Does Not Operate Properly .....	WP 0110-1
No. 3 Discharge Drain Valve (Passenger Side)	
Installation .....	WP 0276-3
Removal .....	WP 0276-1
No. 3 Discharge Valve (Passenger Side)	
Installation .....	WP 0487-3
Removal .....	WP 0487-1
No. 3 Discharge Valve (Passenger Side) Does Not Operate Properly .....	WP 0111-1
No. 4 Discharge Drain Valve (Passenger Side)	
Installation .....	WP 0277-3
Removal .....	WP 0277-1



## ALPHABETICAL INDEX (CONTINUED)

<u>Subject</u>	<u>WP Sequence No.-Page No.</u>
No. 4 Discharge Valve (Passenger Side)	
Installation .....	WP 0488-3
Removal .....	WP 0488-1
No. 4 Discharge Valve (Passenger Side) Does Not Operate Properly .....	WP 0112-1

### O

On-Board Tool Mounting Bracket(s)	
Crew Cab On-Board Tool Mounting Bracket Installation .....	WP 0528-2
Crew Cab On-Board Tool Mounting Bracket Removal .....	WP 0528-1
Rear On-Board Tool Mounting Bracket Installation .....	WP 0528-3
Rear On-Board Tool Mounting Bracket Removal .....	WP 0528-3
On-Truck Load Plan	
General .....	WP 0047-1
On-Truck Load Plan .....	WP 0047-2
Scope .....	WP 0047-1
Operation in Cold Environment, -25 to 32°F (-32 to 0°C) .....	WP 0045-1
Overhead Beacon Light	
Installation .....	WP 0356-2
Removal .....	WP 0356-1

### P

Passenger Seat	
Installation .....	WP 0530-3
Removal .....	WP 0530-1
Passenger Seat Mount	
Installation .....	WP 0529-2
Removal .....	WP 0529-1
Passenger Side and Rear Stowage Compartment Light(s) Do Not Operate .....	WP 0174-1
Passenger Side Auxiliary Inlet and Driver Side Main Inlet Bleeder Valve	
Installation .....	WP 0278-3
Removal .....	WP 0278-1
Passenger Side Auxiliary Inlet Valve Does Not Operate Properly .....	WP 0113-1
Passenger Side Body Wire Harness	
Installation .....	WP 0456-13
Removal .....	WP 0456-2
Personnel Cab Clearance Light and Bracket	
Installation .....	WP 0344-3
Removal .....	WP 0344-1
Personnel Cab Do Not Move Apparatus Indicator	
Installation .....	WP 0305-2
Removal .....	WP 0305-1
Personnel Cab Foam Tank Selector Indicator	
Installation .....	WP 0306-2
Removal .....	WP 0306-1

## ALPHABETICAL INDEX (CONTINUED)

<u>Subject</u>	<u>WP Sequence No.-Page No.</u>
Personnel Cab Foam Tank Selector Indicator Lamp	
Installation .....	WP 0307-2
Removal .....	WP 0307-1
Personnel Cab Foam Tank Selector Switch	
Installation .....	WP 0308-2
Removal .....	WP 0308-1
Personnel Cab Front Lightbar	
Assembly .....	WP 0347-2
Disassembly .....	WP 0347-2
Installation .....	WP 0345-3
Removal .....	WP 0345-1
Personnel Cab Governor Control Panel	
Installation .....	WP 0309-2
Removal .....	WP 0309-1
Personnel Cab High Idle Switch and Indicator	
Installation .....	WP 0310-2
Removal .....	WP 0310-1
Personnel Cab Instrument Panel	
Panel A installation .....	WP 0311-5
Panel A Removal .....	WP 0311-2
Panel B Installation .....	WP 0311-9
Panel B Removal .....	WP 0311-8
Panel C Installation .....	WP 0311-10
Panel C Removal .....	WP 0311-10
Panel D installation .....	WP 0311-11
Panel D Removal .....	WP 0311-11
Panel E Installation .....	WP 0311-12
Panel E Removal .....	WP 0311-12
Personnel Cab Instrument Panel Assembly	
Installation .....	WP 0312-5
Removal .....	WP 0312-1
Personnel Cab Panel Indicator	
Installation .....	WP 0313-2
Removal .....	WP 0313-1
Personnel Cab Panel Indicator Lamp(s)	
Installation .....	WP 0314-2
Removal .....	WP 0314-1
Personnel Cab Power Distribution Block	
Installation .....	WP 0400-4
Removal .....	WP 0400-1
Personnel Cab Power Distribution Box Circuit Breaker	
Installation .....	WP 0398-2
Removal .....	WP 0398-1
Personnel Cab Power Distribution Box Diode Block	
Installation .....	WP 0399-2
Removal .....	WP 0399-1
Personnel Cab Power Distribution Box Fuse	
Installation .....	WP 0401-2
Removal .....	WP 0401-1

## ALPHABETICAL INDEX (CONTINUED)

<u>Subject</u>	<u>WP Sequence No.-Page No.</u>
Personnel Cab Power Distribution Box Relays	
Installation .....	WP 0402-2
Removal .....	WP 0402-1
Personnel Cab Roof Lightbar Flasher Unit	
Installation .....	WP 0403-3
Removal .....	WP 0403-1
Personnel Cab SCBA Seat Repair	
Installation .....	WP 0532-4
Removal .....	WP 0532-1
Personnel Cab Side Lightbar	
Assembly .....	WP 0347-1
Disassembly .....	WP 0347-1
Installation .....	WP 0346-2
Removal .....	WP 0346-1
Personnel Cab Step	
Installation .....	WP 0533-4
Removal .....	WP 0533-1
Personnel Cab Step Clearance Light	
Installation .....	WP 0404-3
Removal .....	WP 0404-1
Personnel Cab Toggle Switch	
Installation .....	WP 0315-2
Removal .....	WP 0315-1
Personnel Cab Warning Light and Do Not Move Apparatus Flasher Units	
Installation .....	WP 0348-2
Removal .....	WP 0348-1
Personnel Cab Water and/or Foam Level Gauge(s)	
Installation .....	WP 0316-2
Removal .....	WP 0316-1
Piping Assembly (Pipe Thread Sealing Compound)	
Assembly .....	WP 0489-1
Piping Heat Trace	
Installation .....	WP 0606-7
Removal .....	WP 0606-1
Piping Heat Trace Does Not Operate Properly .....	WP 0181-1
Plumbing Insulation	
Installation .....	WP 0607-2
Removal .....	WP 0607-1
Plumbing, Hoses, and Piping	
Foam and Water Tank Fill Systems .....	WP 0490-4
Ground Sweeps and Thermal Relief Systems .....	WP 0490-14
Pre-Connect System .....	WP 0490-10
Priming System .....	WP 0490-18
Roof and Bumper Turret Systems .....	WP 0490-12
Side Discharge System .....	WP 0490-8
Water Intake System .....	WP 0490-1
Windshield Deluge System .....	WP 0490-16

## ALPHABETICAL INDEX (CONTINUED)

<u>Subject</u>	<u>WP Sequence No.-Page No.</u>
Pneumatic Spring	
Installation .....	WP 0534-2
Removal .....	WP 0534-1
Portable Handheld Flashlight and Charger	
Installation .....	WP 0405-2
Removal .....	WP 0405-1
Portable Handheld Radio and Charger	
Installation .....	WP 0406-3
Removal .....	WP 0406-1
Post Operation Procedures .....	WP 0041-1
Power Cable Assembly (SINCGARS)	
Installation .....	WP 0409-2
Removal .....	WP 0409-1
Power Distribution Box (Pump House)	
Installation .....	WP 0407-2
Removal .....	WP 0407-1
Power Distribution Box Control Panel (Pump House)	
Installation .....	WP 0408-2
Removal .....	WP 0408-1
Power Steering Pump Modification	
Installation .....	WP 0535-6
Modification of New Steering Pump .....	WP 0535-2
Removal .....	WP 0535-1
Power Take Off (PTO)	
Installation .....	WP 0600-2
Removal .....	WP 0600-1
Power Take Off (PTO) Pump	
Installation .....	WP 0601-4
Removal .....	WP 0601-1
Power Take Off (PTO) Solenoid and Pressure Switch	
Installation .....	WP 0602-2
Removal .....	WP 0602-1
Pre-Connect Nozzle Storage Cups	
Installation .....	WP 0536-2
Removal .....	WP 0536-1
Pre-Connect Roller Assembly	
Installation .....	WP 0537-3
Removal .....	WP 0537-1
Pre-Connects	
Driver Side Pre-Connect A Installation .....	WP 0577-2
Driver Side Pre-Connect A Removal .....	WP 0577-1
Driver Side Pre-Connect B Installation .....	WP 0577-5
Driver Side Pre-Connect B Removal .....	WP 0577-4
Preparation for Operation-Operational Modes .....	WP 0006-1
Preparation for Storage or Shipment	
Preparation for Shipment .....	WP 0043-13
Preparation for Storage (Long Term - 6 Months or Longer) .....	WP 0043-1
Prepare to Operate Vehicle .....	WP 0005-1

## ALPHABETICAL INDEX (CONTINUED)

<u>Subject</u>	<u>WP Sequence No.-Page No.</u>
Pressure Governor Adjustment	
Pressure Governor Gain Adjustment .....	WP 0193-2
Pressure Governor PReset PSI Adjustment .....	WP 0193-4
Pressure Governor Ramp Adjustment .....	WP 0193-2
Pressure Governor Sensitivity Adjustment .....	WP 0193-3
Pressure Governor Operation .....	WP 0024-1
Pressure Reducing Valve Driver Pre-Connect "A"	
Installation .....	WP 0491-3
Removal .....	WP 0491-1
Pressure Reducing Valve Driver Pre-Connect "B"	
Installation .....	WP 0492-2
Removal .....	WP 0492-1
Pressure Regulator	
Installation .....	WP 0410-2
Removal .....	WP 0410-1
Pressure Transducer	
Installation .....	WP 0411-2
Removal .....	WP 0411-1
Pressure Transducer Wire Harness	
Installation .....	WP 0460-3
Removal .....	WP 0460-2
Preventive Maintenance Checks and Services (PMCS) Introduction .....	WP 0185-1
Preventive Maintenance Checks and Services (PMCS), Including Lubrication Instructions .....	WP 0186-1
Primer Pump	
Assembly .....	WP 0263-4
Cleaning/Inspection .....	WP 0263-3
Disassembly .....	WP 0263-1
Installation .....	WP 0262-3
Removal .....	WP 0262-1
Primer Pump Motor Control Solenoid	
Installation .....	WP 0260-2
Removal .....	WP 0260-1
Primer Pump Valve Motor Inline Fuse	
Installation .....	WP 0261-2
Removal .....	WP 0261-1
Primer Tank	
Installation .....	WP 0264-2
Removal .....	WP 0264-1
Primer Valve Cable	
Installation .....	WP 0265-2
Removal .....	WP 0265-1
Primer Valve Control Solenoid(s)	
Driver Side Inlet Prime Valve Solenoid Installation .....	WP 0266-4
Driver Side Inlet Prime Valve Solenoid Removal .....	WP 0266-3
Pump Primer Solenoid Installation .....	WP 0266-2
Pump Primer Solenoid Removal .....	WP 0266-1
Priming Water Pump .....	WP 0023-1
Pump and Plumbing Blow-Out Procedures .....	WP 0044-1
Pump and Roll Procedures .....	WP 0028-1

## ALPHABETICAL INDEX (CONTINUED)

<u>Subject</u>	<u>WP Sequence No.-Page No.</u>
Pump Cooler (Dump-To-Ground) Valve	
Installation .....	WP 0578-2
Removal .....	WP 0578-1
PUMP COOLER Indicator Does Not Illuminate (Pump Operator's Panel) .....	WP 0136-1
Pump Cooler Open Indicator Does Not Illuminate (Cab) .....	WP 0135-1
Pump Cooler Valve Does Not Operate Properly .....	WP 0114-1
Pump Digital Pressure Gauge(s) (Discharge and Intake)	
Installation .....	WP 0317-2
Removal .....	WP 0317-1
Pump Does Not Prime .....	WP 0064-1
Pump Engine Cranks But Fails to Start .....	WP 0061-1
Pump Engine Governor Control Does Not Operate .....	WP 0062-1
PUMP ENGINE RUNNING Indicator Not Illuminated When Water Pump Engine is Running .....	WP 0137-1
Pump Engine Runs Rough or Shuts Down While Running .....	WP 0063-1
PUMP HOT Alarm/Indicator Does Not Operate When Tested or Pump Overheat Condition (Pump Operator's Panel) .....	WP 0138-1
Pump House Access Doors	
Installation .....	WP 0538-3
Removal .....	WP 0538-1
Pump House Cooling Fan	
Installation .....	WP 0416-2
Removal .....	WP 0416-1
Pump House Cooling Fan Temperature Switch	
Installation .....	WP 0414-2
Removal .....	WP 0414-1
Pump House Distribution Box Circuit Breaker	
Installation .....	WP 0412-2
Removal .....	WP 0412-1
Pump House Distribution Box Relay	
Installation .....	WP 0413-2
Removal .....	WP 0413-1
Pump House Fan Does Not Operate Properly .....	WP 0175-1
Pump House Heater	
Installation .....	WP 0469-3
Removal .....	WP 0469-1
Pump House Heater Diagnostic Module	
Installation .....	WP 0415-3
Removal .....	WP 0415-1
Pump House Heater Does Not Operate Properly .....	WP 0182-1
Pump House or Pump Operator's Panel Work Light(s) Does Not Operate .....	WP 0176-1
Pump House Panel A	
Close .....	WP 0539-2
Open .....	WP 0539-1

**ALPHABETICAL INDEX (CONTINUED)**

<u>Subject</u>	<u>WP Sequence No.-Page No.</u>
Pump House Panels	
General .....	WP 0540-1
Pump Panel A Installation .....	WP 0540-4
Pump Panel A Removal .....	WP 0540-2
Pump Panel B Installation .....	WP 0540-7
Pump Panel B Removal .....	WP 0540-6
Pump Panel C Installation .....	WP 0540-8
Pump Panel C Removal .....	WP 0540-8
Pump Panel D Installation .....	WP 0540-9
Pump Panel D Removal .....	WP 0540-9
Pump Panel E Installation .....	WP 0540-11
Pump Panel E Removal .....	WP 0540-11
Pump Panel F Installation .....	WP 0540-12
Pump Panel F Removal .....	WP 0540-12
Pump Panel G Installation .....	WP 0540-13
Pump Panel G Removal .....	WP 0540-13
Pump Panel H Installation .....	WP 0540-14
Pump Panel H Removal .....	WP 0540-14
Pump Panel I Installation .....	WP 0540-16
Pump Panel I Removal .....	WP 0540-15
Pump Panel J Installation .....	WP 0540-17
Pump Panel J Removal .....	WP 0540-16
Pump Panel K Installation .....	WP 0540-18
Pump Panel K Removal .....	WP 0540-17
Pump Panel L Installation .....	WP 0540-19
Pump Panel L Removal .....	WP 0540-18
Pump Panel M Installation .....	WP 0540-21
Pump Panel M Removal .....	WP 0540-20
Pump Panel N Installation .....	WP 0540-22
Pump Panel N Removal .....	WP 0540-22
Pump Panel O Installation .....	WP 0540-23
Pump Panel O Removal .....	WP 0540-23
Pump Panel P Installation .....	WP 0540-24
Pump Panel P Removal .....	WP 0540-24
Pump Panel Q Installation .....	WP 0540-25
Pump Panel Q Removal .....	WP 0540-25
Pump Panel R Installation .....	WP 0540-26
Pump Panel R Removal .....	WP 0540-26
Pump Panel S Installation .....	WP 0540-27
Pump Panel S Removal .....	WP 0540-27
Pump Panel T Installation .....	WP 0540-28
Pump Panel T Removal .....	WP 0540-28
Pump Panel U Installation .....	WP 0540-29
Pump Panel U Removal .....	WP 0540-29
Pump House Power Distribution Wire Harness and Block	
Installation .....	WP 0457-4
Removal .....	WP 0457-1

## ALPHABETICAL INDEX (CONTINUED)

<u>Subject</u>	<u>WP Sequence No.-Page No.</u>
Pump House Wire Harness	
Installation .....	WP 0458-11
Removal .....	WP 0458-1
Pump Loses Prime .....	WP 0065-1
Pump Operator's Panel	
Close .....	WP 0019-3
Installation .....	WP 0334-3
Open .....	WP 0019-1
Removal .....	WP 0334-2
Pump Operator's Panel Air Flow Restrictor Indicator	
Installation .....	WP 0318-2
Removal .....	WP 0318-1
Pump Operator's Panel Cover	
Installation .....	WP 0320-3
Removal .....	WP 0320-1
Pump Operator's Panel Electric Valve Control	
Installation .....	WP 0418-2
Removal .....	WP 0418-1
Pump Operator's Panel Electric Valve Control/Meter	
Installation .....	WP 0417-2
Removal .....	WP 0417-1
Pump Operator's Panel Engine Diagnostics Plug	
Installation .....	WP 0321-2
Removal .....	WP 0321-1
Pump Operator's Panel Foam Level Gauge	
Installation .....	WP 0322-2
Removal .....	WP 0322-1
Pump Operator's Panel Fuel Gauge	
Installation .....	WP 0323-2
Removal .....	WP 0323-1
Pump Operator's Panel Hourmeter	
Installation .....	WP 0324-2
Removal .....	WP 0324-1
Pump Operator's Panel Housing Open/Close	
Close .....	WP 0325-2
Open .....	WP 0325-1
Pump Operator's Panel Indicator Lamp	
Installation .....	WP 0327-1
Removal .....	WP 0327-1
Pump Operator's Panel Indicator Light	
Installation .....	WP 0326-2
Removal .....	WP 0326-1
Pump Operator's Panel Light Switch	
Installation .....	WP 0328-2
Removal .....	WP 0328-1
Pump Operator's Panel Manual Primer Handle	
Installation .....	WP 0329-2
Removal .....	WP 0329-1



## ALPHABETICAL INDEX (CONTINUED)

<u>Subject</u>	<u>WP Sequence No.-Page No.</u>
Pump Operator's Panel Momentary Toggle Switch	
Installation .....	WP 0330-2
Removal .....	WP 0330-1
Pump Operator's Panel Overheat Test Button	
Installation .....	WP 0331-2
Removal .....	WP 0331-1
Pump Operator's Panel Pressure Governor Control Panel	
Installation .....	WP 0332-2
Removal .....	WP 0332-1
Pump Operator's Panel Primer Switch	
Installation .....	WP 0333-2
Removal .....	WP 0333-1
Pump Operator's Panel Side Lamp and Bracket	
Installation .....	WP 0335-2
Removal .....	WP 0335-1
Pump Operator's Panel Test Gauge Panel	
Installation .....	WP 0336-5
Removal .....	WP 0336-1
Pump Operator's Panel Three-Position Toggle Switch	
Installation .....	WP 0337-2
Removal .....	WP 0337-1
Pump Operator's Panel Two-Position Toggle Switch	
Installation .....	WP 0338-2
Removal .....	WP 0338-1
Pump Operator's Panel Water Level Gauge	
Installation .....	WP 0339-2
Removal .....	WP 0339-1
Pump Operator's Panel Wire Harness	
Installation .....	WP 0459-21
Removal .....	WP 0459-1
Pump Operator's Platform	
Installation .....	WP 0541-4
Removal .....	WP 0541-1
Stow .....	WP 0016-2
Unstow .....	WP 0016-1
Pump Primer Motor Diode Pack	
Installation .....	WP 0419-1
Removal .....	WP 0419-1
Pump Primer Valve	
Installation .....	WP 0267-4
Removal .....	WP 0267-1
Pump Priming System Does Not Operate Properly .....	WP 0115-1
Pumping from Draft (Main Inlet) .....	WP 0025-1
Pumping from Hydrant or In Relay (Positive Water Sources) .....	WP 0027-1
Pumping From Onboard Water Tank .....	WP 0026-1

**ALPHABETICAL INDEX (CONTINUED)**

<u>Subject</u>	<u>WP Sequence No.-Page No.</u>
<b>R</b>	
Rear Access Ladder	
Installation .....	WP 0542-3
Removal .....	WP 0542-1
Rear Body Wire Harness	
Installation .....	WP 0461-5
Removal .....	WP 0461-1
Rear Compartment Heater	
Installation .....	WP 0471-4
Removal .....	WP 0471-1
Rear Compartment Heater Diagnostic Module	
Installation .....	WP 0470-3
Removal .....	WP 0470-1
Rear Compartment Heater Does Not Operate Properly .....	WP 0183-1
Rear Compartment Mounting Brackets	
Installation .....	WP 0543-7
Removal .....	WP 0543-1
Rear Compartment Utility Tilt Tray	
Installation .....	WP 0544-5
Removal .....	WP 0544-1
Rear Hard Lift	
Installation .....	WP 0545-4
Removal .....	WP 0545-1
Rear Heater Thermostat	
Installation .....	WP 0472-3
Removal .....	WP 0472-1
Rear Marker/Clearance LED	
Installation .....	WP 0349-2
Removal .....	WP 0349-1
Rear Splash Guard	
Installation .....	WP 0546-2
Removal .....	WP 0546-1
Rear Step Buzzer Button and Cable	
Installation .....	WP 0420-2
Removal .....	WP 0420-1
Rear Step Buzzer Button Compartment	
Installation .....	WP 0421-2
Removal .....	WP 0421-1
Rear Step Buzzer Does Not Operate Properly .....	WP 0178-1
Rear Work Platform	
Assembly .....	WP 0547-7
Disassembly .....	WP 0547-4
Installation .....	WP 0547-11
Removal .....	WP 0547-2
Stow .....	WP 0014-2
Unstow .....	WP 0014-1
References .....	WP 0620-1

## ALPHABETICAL INDEX (CONTINUED)

<u>Subject</u>	<u>WP Sequence No.-Page No.</u>
Remote Intercom	
Installation .....	WP 0422-2
Removal .....	WP 0422-1
Repair Parts and Special Tools List (RPSTL) Introduction	
Explanation of Columns in the Repair Parts List and Special Tools List Work Packages .....	WP 0610-2
Explanation of Cross-Reference Indexes Work Packages Format and Columns .....	WP 0610-6
General .....	WP 0610-1
How to Locate Repair Parts .....	WP 0610-7
Scope .....	WP 0610-1
Special Information .....	WP 0610-6
Repair Parts and Special Tools List (RPSTL) NSN Index .....	WP 0618-1
Repair Parts and Special Tools List (RPSTL) Part Number Index .....	WP 0619-1
Right Rear Access Ladder	
Stow .....	WP 0013-2
Unstow .....	WP 0013-1
Roof Mounted Clearance Lights	
Installation .....	WP 0350-4
Removal .....	WP 0350-1
Roof Turret and Controls Repair	
Handle and Roof Turret Assembly .....	WP 0581-16
Handle and Roof Turret Cleaning /Inspection .....	WP 0581-15
Handle and Roof Turret Disassembly .....	WP 0581-6
Nozzle Body Assembly .....	WP 0581-4
Nozzle Body Cleaning and Inspection .....	WP 0581-3
Nozzle Body Disassembly .....	WP 0581-1
Nozzle Pattern Handle and Cable Assembly .....	WP 0581-31
Nozzle Pattern Handle and Cable Cleaning and Inspection .....	WP 0581-30
Nozzle Pattern Handle and Cable Disassembly .....	WP 0581-27
Roof Turret Control Valve	
Installation .....	WP 0424-4
Removal .....	WP 0424-1
Roof Turret Does Not Operate When Selected .....	WP 0116-1
Roof Turret Indicator Does Not Operate .....	WP 0140-1
Roof Turret Mounting Plate	
Installation .....	WP 0565-2
Removal .....	WP 0565-1
Roof Turret Operation .....	WP 0036-1
Roof Turret Plumbing Cover	
Installation .....	WP 0548-2
Removal .....	WP 0548-1
Roof Turret Valve	
Installation .....	WP 0580-2
Removal .....	WP 0580-1
Roof Turret, Automatic Drain Valve, and Controls	
Installation .....	WP 0579-7
Removal .....	WP 0579-1
Roof, Bumper, and Pump Cooler Dump-To-Ground Junction Box	
Installation .....	WP 0423-3
Removal .....	WP 0423-1

**ALPHABETICAL INDEX (CONTINUED)**

<u>Subject</u>	<u>WP Sequence No.-Page No.</u>
<b>S</b>	
SCBA Seat Belt	
Installation .....	WP 0549-3
Removal .....	WP 0549-1
Shoreline Inlet Receptacle	
Installation .....	WP 0425-2
Removal .....	WP 0425-1
Shoreline Inlet Receptacle Does Not Operate Properly .....	WP 0180-1
Shutoff Control Valve Diode Pack	
Installation .....	WP 0426-2
Removal .....	WP 0426-1
Shutoff Control Valve Manifold	
Installation .....	WP 0427-4
Removal .....	WP 0427-1
SINGGARS and Two-Way Radio Intercom Cable	
SINGGARS Interface Wire Harness Installation .....	WP 0462-2
SINGGARS Interface Wire Harness Removal .....	WP 0462-1
Two-Way Radio Interface Wire Harness Installation .....	WP 0462-4
Two-Way Radio Interface Wire Harness Removal .....	WP 0462-3
SINGGARS Do Not Operate Properly .....	WP 0179-1
SINGGARS Radio Cover	
Close .....	WP 0017-1
Open .....	WP 0017-1
Siren Control	
Installation .....	WP 0341-2
Removal .....	WP 0341-1
Siren Does Not Operate Properly .....	WP 0150-1
Skid Plate Grille	
Installation .....	WP 0550-2
Removal .....	WP 0550-1
Small Compartment Doors	
Pump House Panel Doors Installation .....	WP 0551-2
Pump House Panel Doors Removal .....	WP 0551-1
SCBA Tank Access Door/Rear Step Buzzer Access Door Installation .....	WP 0551-5
SCBA Tank Access Door/Rear Step Buzzer Access Door Removal .....	WP 0551-4
Speaker	
Installation .....	WP 0428-2
Removal .....	WP 0428-1
Spreader Bar Bracket	
Installation .....	WP 0552-3
Removal .....	WP 0552-1
Stowage and Data Plate Guide	
General .....	WP 0046-1
Scope .....	WP 0046-1
Stowage Box	
Installation .....	WP 0553-2
Removal .....	WP 0553-1

## ALPHABETICAL INDEX (CONTINUED)

<u>Subject</u>	<u>WP Sequence No.-Page No.</u>
Stowage Compartment Door	
Horizontal Hinged Door Installation .....	WP 0555-8
Horizontal Hinged Door Removal .....	WP 0555-7
Vertical Hinged Door Installation .....	WP 0555-4
Vertical Hinged Door Removal .....	WP 0555-1
Stowage Compartment Door Latch	
Installation .....	WP 0554-2
Removal .....	WP 0554-1
Streamlight Battery Charger(s) Does Not Charge Batteries .....	WP 0059-1
<b>T</b>	
TANK DRAIN Indicator Does Not Illuminate (Pump Operator's Panel) .....	WP 0141-1
Tank Fill & Re-Circulating Valve Does Not Operate Properly .....	WP 0118-1
TANK TO PUMP Indicator Does Not Illuminate (Cab) .....	WP 0142-1
TANK TO PUMP Indicator Does Not Illuminate (Pump Operator's Panel) .....	WP 0143-1
Tank-To-Pump Check Valve (Driver Side)	
Installation .....	WP 0295-2
Removal .....	WP 0295-1
Tank-To-Pump Check Valve (Passenger Side)	
Installation .....	WP 0296-2
Removal .....	WP 0296-1
Tank-To-Pump Intake Valve (Driver Side)	
Installation .....	WP 0493-2
Removal .....	WP 0493-1
Tank-To-Pump Intake Valve (Passenger Side)	
Installation .....	WP 0494-2
Removal .....	WP 0494-1
Tank-To-Pump Valve(s) Does Not Operate Properly .....	WP 0119-1
Terminal Block (Pass-Through)	
Installation .....	WP 0429-2
Removal .....	WP 0429-1
Theory of Operation	
120/240 VAC Hydraulic Generator System .....	WP 0003-3
Crew Cab .....	WP 0003-2
Foam System .....	WP 0003-2
Pressure Governor .....	WP 0003-3
System Introduction .....	WP 0003-1
Water Pump Engine .....	WP 0003-1
Water Pumping System .....	WP 0003-1
Windshield Deluge System .....	WP 0003-1
Winterization Package .....	WP 0003-3
Thermal Relief Valve	
Installation .....	WP 0259-2
Removal .....	WP 0259-1
Threaded Screw Insert	
Installation .....	WP 0556-2
Removal .....	WP 0556-1

**ALPHABETICAL INDEX (CONTINUED)**

<u>Subject</u>	<u>WP Sequence No.-Page No.</u>
Top Stowage Compartment Door	
Installation .....	WP 0557-2
Removal .....	WP 0557-1
Torque Limits	
How to Use Torque Tables .....	WP 0609-1
Scope .....	WP 0609-1
Torque Limits .....	WP 0609-1
Transmission	
Installation .....	WP 0558-10
Removal .....	WP 0558-1
Transmission Dipstick and Tube	
Installation .....	WP 0559-2
Removal .....	WP 0559-1
Troubleshooting Fault Index	
Field Level .....	WP 0050-1
Operator Level .....	WP 0049-1
Troubleshooting Instructions Introduction .....	WP 0048-1
Turret Bumper Mount	
Installation .....	WP 0566-2
Removal .....	WP 0566-1
Two-Way Radio	
Installation .....	WP 0430-3
Removal .....	WP 0430-1
Two-Way Radio Does Not Operate Properly .....	WP 0170-1

**U**

Utility Outlet	
Crew Cab Utility Outlet Installation .....	WP 0431-2
Crew Cab Utility Outlet Removal .....	WP 0431-2
Personnel Cab Utility Outlet Removal .....	WP 0431-1

**V**

Valve Control Wire Harness	
Installation .....	WP 0463-5
Removal .....	WP 0463-1
Valve Driver Pre-Connect "A"	
Installation .....	WP 0495-3
Removal .....	WP 0495-1
Valve Driver Pre-Connect "B"	
Installation .....	WP 0496-2
Removal .....	WP 0496-1

**ALPHABETICAL INDEX (CONTINUED)**

**Subject**

**WP Sequence No.-Page No.**

**W**

Warning Lights	
Installation .....	WP 0351-2
Removal .....	WP 0351-1
Warning Lights (All) Do Not Operate .....	WP 0151-1
Warning Lights (Cab Roof Lightbar) Do Not Operate .....	WP 0154-1
Warning Lights (Front and Rear) Do Not Operate .....	WP 0152-1
Warning Lights (Overhead Beacon) Do Not Operate .....	WP 0153-1
Warning Lights (Side) Do Not Operate .....	WP 0155-1
Warning Lights (Upper Rear) Do Not Operate .....	WP 0156-1
Warning Lights Do Not Operate .....	WP 0068-1
Water Level Probe	
Installation .....	WP 0297-2
Removal .....	WP 0297-1
Water Pump	
Installation .....	WP 0255-18
Removal .....	WP 0255-2
Water Pump and Water Tank	
Water Pump Flush .....	WP 0042-1
Water Tank Flush .....	WP 0042-6
Water Pump Engine	
Engine Installation .....	WP 0219-26
Engine Removal .....	WP 0219-16
Frame Rail Extension Installation .....	WP 0219-11
Frame Rail Extension Removal .....	WP 0219-37
Installation .....	WP 0219-40
Removal .....	WP 0219-2
Water Pump Engine (Cab Instrument Panel and Pump Operator's Panel)	
Starting Water Pump Engine (Engage Pump) .....	WP 0022-1
Stopping Water Pump Engine (Disengage Pump) .....	WP 0022-4
Water Pump Engine Air Cleaner Assembly	
Installation .....	WP 0220-3
Removal .....	WP 0220-1
Water Pump Engine Air Filter Ductwork	
Installation .....	WP 0221-5
Removal .....	WP 0221-1
Water Pump Engine Air Intake Pre-Filter	
Installation .....	WP 0222-1
Removal .....	WP 0222-1
Water Pump Engine Alternator	
Installation .....	WP 0223-2
Removal .....	WP 0223-1
Water Pump Engine Alternator Belt	
Installation/Adjustment .....	WP 0224-2
Removal .....	WP 0224-1

## ALPHABETICAL INDEX (CONTINUED)

<u>Subject</u>	<u>WP Sequence No.-Page No.</u>
Water Pump Engine Battery Cables	
Installation .....	WP 0225-3
Removal .....	WP 0225-1
Water Pump Engine Compression Test	
Test .....	WP 0194-1
Water Pump Engine Coolant Hoses and Tubes	
Installation .....	WP 0476-3
Removal .....	WP 0476-1
Water Pump Engine Coolant Level Sensor	
Installation .....	WP 0474-2
Removal .....	WP 0474-1
Water Pump Engine Coolant Level Sight Glass	
Installation .....	WP 0475-2
Removal .....	WP 0475-1
Water Pump Engine Coolant Pump	
Cleaning/Inspection .....	WP 0477-2
Installation .....	WP 0477-3
Removal .....	WP 0477-1
Water Pump Engine Coolant Temperature Sensor	
Installation .....	WP 0480-2
Removal .....	WP 0480-1
Water Pump Engine Coolant/Fuel Pump Belts	
Installation/Adjustment .....	WP 0473-2
Removal .....	WP 0473-1
Water Pump Engine Coolant/Fuel Pump Belts Adjustment	
Adjustment .....	WP 0195-1
Water Pump Engine Cooling System Pressure Test	
Test .....	WP 0478-1
Water Pump Engine Cooling System Service	
Drain Cooling System .....	WP 0479-1
Fill Cooling System .....	WP 0479-2
Water Pump Engine Cranks But Will Not Start or Hard to Start From Personnel Cab and Pump Operator's Panel .....	WP 0073-1
Water Pump Engine Electronic Control Unit (ECU)	
Installation .....	WP 0226-2
Removal .....	WP 0226-1
Water Pump Engine Exhaust Manifold	
Installation .....	WP 0227-2
Removal .....	WP 0227-1
Water Pump Engine Exhaust Pipes	
Installation .....	WP 0228-2
Removal .....	WP 0228-1
Water Pump Engine Expansion Plug	
Installation .....	WP 0229-2
Removal .....	WP 0229-1
Water Pump Engine Fails To Crank From Personnel Cab .....	WP 0075-1
Water Pump Engine Fails To Crank From Personnel Cab and Pump Operator's Panel .....	WP 0074-1
Water Pump Engine Fails To Crank From Pump Operator's Panel .....	WP 0076-1



## ALPHABETICAL INDEX (CONTINUED)

<u>Subject</u>	<u>WP Sequence No.-Page No.</u>
Water Pump Engine Fan Belts	
Installation/Adjustment .....	WP 0230-3
Removal .....	WP 0230-1
Water Pump Engine Fuel Filter	
Installation .....	WP 0231-3
Removal .....	WP 0231-1
Water Pump Engine Fuel Filter Head	
Installation .....	WP 0232-2
Removal .....	WP 0232-1
Water Pump Engine Fuel Injector(s)	
Installation .....	WP 0233-4
Removal .....	WP 0233-1
Water Pump Engine Fuel Line Check Valve(s)	
Installation .....	WP 0235-3
Removal .....	WP 0235-1
Water Pump Engine Fuel Lines	
Installation .....	WP 0234-5
Removal .....	WP 0234-1
Water Pump Engine Fuel Pump	
Installation .....	WP 0236-3
Removal .....	WP 0236-2
Water Pump Engine Fuel System Bleed	
Fuel System Bleed .....	WP 0237-1
Water Pump Engine Fuel/Water Separator	
Installation .....	WP 0238-5
Removal .....	WP 0238-2
Water Pump Engine Gauge Panel	
Installation .....	WP 0340-2
Removal .....	WP 0340-1
Water Pump Engine Gauge Panel Does Not Operate Properly .....	WP 0149-1
Water Pump Engine Glow Plug	
Installation .....	WP 0239-2
Removal .....	WP 0239-1
Water Pump Engine Heat Exchanger	
Installation .....	WP 0240-2
Removal .....	WP 0240-1
Water Pump Engine Hourmeter Does Not Operate .....	WP 0084-1
Water Pump Engine is Hard To Start When Cold, Below 32°F (0°C) .....	WP 0085-1
Water Pump Engine is Producing Blue Exhaust Smoke, Water Temp Reads Over 180°F (82°C) .....	WP 0086-1
Water Pump Engine is Producing Excessive Black or Gray Exhaust Smoke, Water Temp Reads Over 180°F (82°C) .....	WP 0087-1
Water Pump Engine is Producing White Exhaust Smoke, Water Temp Reads Over 180°F (82°C) ....	WP 0088-1
Water Pump Engine Misfires, Runs Rough, or Lacks Power .....	WP 0089-1
Water Pump Engine Muffler	
Installation .....	WP 0241-3
Removal .....	WP 0241-2
Water Pump Engine Noise Panels	
Installation .....	WP 0242-2
Removal .....	WP 0242-1

## ALPHABETICAL INDEX (CONTINUED)

<u>Subject</u>	<u>WP Sequence No.-Page No.</u>
Water Pump Engine Oil Consumption is High or Leaks Oil .....	WP 0091-1
Water Pump Engine Oil Drain/Fill	
Drain Oil .....	WP 0243-1
Oil Fill .....	WP 0243-2
Water Pump Engine Oil Filter	
Installation .....	WP 0244-2
Removal .....	WP 0244-1
Water Pump Engine Oil Pressure is Low or Water Pump Engine Starts and Stops .....	WP 0092-1
Water Pump Engine Oil Pressure Sending Unit	
Installation .....	WP 0245-2
Removal .....	WP 0245-1
Water Pump Engine Oil Pressure Switch	
Installation .....	WP 0246-2
Removal .....	WP 0246-1
Water Pump Engine Overheats .....	WP 0093-1
Water Pump Engine Pressure Governor Control Panel Changes Engine Speed, But Oscillates While In PSI Mode .....	WP 0081-1
Water Pump Engine Pressure Governor Control Panel Changes Engine Speed, But Oscillates While In RPM Mode .....	WP 0080-1
Water Pump Engine Pressure Governor Control Panel Does Not Change Engine Speed .....	WP 0077-1
Water Pump Engine Pressure Governor Control Panel Does Not Change Pump Pressure .....	WP 0078-1
Water Pump Engine Pressure Governor Control Panel Does Not Operate Properly .....	WP 0146-1
Water Pump Engine Pressure Governor Control Panel is Not Disabled, When Other Governor Control Panel is Activated .....	WP 0145-1
Water Pump Engine Pressure Governor Control Panel Message Center Displays Sensor or Cavitate	WP 0079-1
Water Pump Engine Pressure Governor Control Panel Message Display is Garbled or Dim .....	WP 0148-1
Water Pump Engine Pressure Governor Control Panel PSI PRESET Control Does Not Operate .....	WP 0083-1
Water Pump Engine Pressure Governor Control Panel Throttle Ready and/or Pump Engage LEDs Do Not Illuminate .....	WP 0147-1
Water Pump Engine Pressure Governor Controls Do Not Maintain System Pressure When Discharge Valve is Being Opened or Closed .....	WP 0082-1
Water Pump Engine Radiator	
Installation .....	WP 0481-3
Removal .....	WP 0481-1
Water Pump Engine Remote Oil Filter Head and Hose	
Installation .....	WP 0247-3
Removal .....	WP 0247-1
Water Pump Engine Starter Motor	
Installation .....	WP 0248-4
Removal .....	WP 0248-1
Water Pump Engine Thermostat	
Installation .....	WP 0249-3
Removal .....	WP 0249-2
Water Pump Engine Turbocharger	
Installation .....	WP 0250-3
Removal .....	WP 0250-1
Water Pump Engine Valve Cover and Gasket	
Installation .....	WP 0251-4
Removal .....	WP 0251-1

## ALPHABETICAL INDEX (CONTINUED)

<u>Subject</u>	<u>WP Sequence No.-Page No.</u>
Water Pump Engine Valve Lash Adjustment and Injection Nozzle Pressure Check	
Injection Nozzle Closure Tightness Check .....	WP 0196-6
Injection Nozzle Pressure Check .....	WP 0196-5
Valve Clearance Adjustment .....	WP 0196-2
Water Pump Engine Wire Harness	
Water Pump Engine Wire Harness Installation .....	WP 0464-7
Water Pump Engine Wire Harness Removal .....	WP 0464-1
Water Pump Gear Case Oil	
Change Oil .....	WP 0252-1
Check Oil Level .....	WP 0253-1
Water Pump Gear Case Oil Fill Hose	
Installation .....	WP 0254-2
Removal .....	WP 0254-1
Water Pump Noisy .....	WP 0090-1
Water Pump Output Pressure is Low .....	WP 0124-1
Water Tank	
Installation .....	WP 0298-6
Removal .....	WP 0298-2
Water Tank Drain Valve	
Installation .....	WP 0279-2
Removal .....	WP 0279-1
Water Tank Drain Valve Does Not Operate When Selected .....	WP 0122-1
Water Tank Fill	
Direct Tank Fill .....	WP 0020-6
Filling From Draft .....	WP 0020-11
Main Inlet .....	WP 0020-1
Overhead Fill .....	WP 0020-10
Water Tank Fill Valve	
Installation .....	WP 0299-2
Removal .....	WP 0299-1
Water Tank Heater	
Installation .....	WP 0300-2
Removal .....	WP 0300-1
Water Tank Heater Control Box	
Breakers and Mounting Strip Installation .....	WP 0301-4
Breakers and Mounting Strip Removal .....	WP 0301-4
Contactors and Mounting Strip Installation .....	WP 0301-7
Contactors and Mounting Strip Removal .....	WP 0301-6
Control Box Installation .....	WP 0301-14
Control Box Removal .....	WP 0301-11
Main Shutoff Control Installation .....	WP 0301-3
Main Shutoff Control Removal .....	WP 0301-3
Opening Water Tank Heater Control Box .....	WP 0301-1
Relays Installation .....	WP 0301-10
Relays Removal .....	WP 0301-10
Terminal Strip Components and Mounting Strip Installation .....	WP 0301-9
Terminal Strip Components and Mounting Strip Removal .....	WP 0301-8
Timer Installation .....	WP 0301-5
Timer Removal .....	WP 0301-5

**ALPHABETICAL INDEX (CONTINUED)**

<u>Subject</u>	<u>WP Sequence No.-Page No.</u>
Water Tank Heater Does Not Operate Properly .....	WP 0184-1
Water Tank Level Indicator Gauge Does Not Operate Properly .....	WP 0123-1
Water Tank Level Probe Wire Harness	
Installation .....	WP 0466-2
Removal .....	WP 0466-1
Water Tank Low Level Switch	
Installation .....	WP 0302-2
Removal .....	WP 0302-1
Water Tank Side Fill Valve	
Installation .....	WP 0303-4
Removal .....	WP 0303-1
Water Tank Vent/Fill	
Installation .....	WP 0304-4
Removal .....	WP 0304-1
Water Valve Wire Harness	
Installation .....	WP 0465-5
Removal .....	WP 0465-1
Wheel Chocks Stowage Compartment	
Installation .....	WP 0560-2
Removal .....	WP 0560-1
Windshield Deluge	
Starting Windshield Deluge System .....	WP 0038-1
Stopping Windshield Deluge System .....	WP 0038-1
Windshield Deluge Motor	
Installation .....	WP 0432-2
Removal .....	WP 0432-1
Windshield Deluge Pump House Strainer Screen	
Installation .....	WP 0561-2
Removal .....	WP 0561-1
Windshield Deluge Shutoff Valve and Strainer Assembly	
Installation .....	WP 0582-4
Removal .....	WP 0582-1
Windshield Deluge System	
Installation .....	WP 0562-4
Removal .....	WP 0562-1
Windshield Deluge System Does Not Operate Properly .....	WP 0125-1
Wire Rope	
Installation .....	WP 0563-2
Removal .....	WP 0563

<b>RECOMMENDED CHANGES TO PUBLICATIONS AND BLANK FORMS</b>  For use of this form, see AR 25-30; the proponent agency is OAASA	Use Part II ( <i>reverse</i> ) for Repair Parts and Special Tool Lists (RPSTL) and Supply Catalogs/Supply Manuals (SC/SM).	DATE
---	--	------

<b>TO:</b> ( <i>Forward to proponent of publication or form</i> ) ( <i>Include ZIP Code</i> )	<b>FROM:</b> ( <i>Activity and location</i> ) ( <i>Include ZIP Code</i> )
---	---

**PART I - ALL PUBLICATIONS (EXCEPT RPSTL AND SC/SM) AND BLANK FORMS**

PUBLICATION/FORM NUMBER	DATE	TITLE
-------------------------	------	-------

ITEM	PAGE	PARA- GRAPH	LINE	FIGURE NO.	TABLE	RECOMMENDED CHANGES AND REASON
------	------	----------------	------	---------------	-------	--------------------------------

--	--	--	--	--	--	--

*\* Reference to line numbers within the paragraph or subparagraph.*

TYPED NAME, GRADE OR TITLE	TELEPHONE EXCHANGE/AUTOVON, PLUS EXTENSION	SIGNATURE
----------------------------	---	-----------

<b>TO:</b> <i>(Forward direct to addressee listed in publication)</i>	<b>FROM:</b> <i>(Activity and location) (Include ZIP Code)</i>	<b>DATE</b>
---	--	-------------

**PART II - REPAIR PARTS AND SPECIAL TOOL LISTS AND SUPPLY CATALOGS/SUPPLY MANUALS**

PUBLICATION NUMBER			DATE	TITLE				
PAGE NO.	COLM NO.	LINE NO.	NATIONAL STOCK NUMBER	REFERENCE NO.	FIGURE NO.	ITEM NO.	TOTAL NO. OF MAJOR ITEMS SUPPORTED	RECOMMENDED ACTION

**PART III - REMARKS** *(Any general remarks or recommendations, or suggestions for improvement of publications and blank forms. Additional blank sheets may be used if more space is needed.)*

TYPED NAME, GRADE OR TITLE	TELEPHONE EXCHANGE/AUTOVON, PLUS EXTENSION	SIGNATURE
----------------------------	--	-----------

<b>RECOMMENDED CHANGES TO PUBLICATIONS AND BLANK FORMS</b>						Use Part II ( <i>reverse</i> ) for Repair Parts and Special Tool Lists (RPSTL) and Supply Catalogs/Supply Manuals (SC/SM).	DATE
<small>For use of this form, see AR 25-30; the proponent agency is OAASA</small>							
TO: ( <i>Forward to proponent of publication or form</i> ) ( <i>Include ZIP Code</i> )				FROM: ( <i>Activity and location</i> ) ( <i>Include ZIP Code</i> )			
<b>PART I - ALL PUBLICATIONS (EXCEPT RPSTL AND SC/SM) AND BLANK FORMS</b>							
PUBLICATION/FORM NUMBER					DATE	TITLE	
ITEM	PAGE	PARA-GRAPH	LINE	FIGURE NO.	TABLE	RECOMMENDED CHANGES AND REASON	
<small>* Reference to line numbers within the paragraph or subparagraph.</small>							
TYPED NAME, GRADE OR TITLE					TELEPHONE EXCHANGE/AUTOVON, PLUS EXTENSION		SIGNATURE

<b>TO:</b> <i>(Forward direct to addressee listed in publication)</i>	<b>FROM:</b> <i>(Activity and location) (Include ZIP Code)</i>	<b>DATE</b>
---	--	-------------

**PART II - REPAIR PARTS AND SPECIAL TOOL LISTS AND SUPPLY CATALOGS/SUPPLY MANUALS**

PUBLICATION NUMBER			DATE	TITLE				
PAGE NO.	COLM NO.	LINE NO.	NATIONAL STOCK NUMBER	REFERENCE NO.	FIGURE NO.	ITEM NO.	TOTAL NO. OF MAJOR ITEMS SUPPORTED	RECOMMENDED ACTION

**PART III - REMARKS** *(Any general remarks or recommendations, or suggestions for improvement of publications and blank forms. Additional blank sheets may be used if more space is needed.)*

TYPED NAME, GRADE OR TITLE	TELEPHONE EXCHANGE/AUTOVON, PLUS EXTENSION	SIGNATURE
----------------------------	--	-----------



By order of the Secretary of the Army:

GEORGE W. CASEY, JR.  
*General, United States Army*  
*Chief of Staff*

Official:

A handwritten signature in black ink that reads "Joyce E. Morrow". The signature is written in a cursive style with a large, stylized initial "J".

JOYCE E. MORROW  
*Administrative Assistant to the*  
*Secretary of the Army*  
0827702

Distribution: To be distributed in accordance with the initial distribution number (IDN) 381211, requirements for TM 5-4210-249-13&P-1.



## THE METRIC SYSTEM AND EQUIVALENTS

### LINEAR MEASURE

1 Centimeter=10 Millimeters=0.01 Meters=0.3937 Inches  
 1 Meter=100 Centimeters=1000 Millimeters=39.37 Inches  
 1 Kilometer=1000 Meters=0.621 Miles

### WEIGHTS

1 Gram=0.001 Kilograms=1000 Milligrams=0.035 Ounces  
 1 Kilogram=1000 Grams=2.2 Lb  
 1 Metric Ton=1000 Kilograms=1 Megagram=1.1 Short Tons

### LIQUID MEASURE

1 Milliliter=0.001 Liters=0.0338 Fluid Ounces  
 1 Liter=1000 Milliliters=33.82 Fluid Ounces

### SQUARE MEASURE

1 Sq Centimeter=100 Sq Millimeters=0.155 Sq Inches  
 1 Sq Meter=10,000 Sq Centimeters=10.76 Sq Feet  
 1 Sq Kilometer=1,000,000 Sq Meters=0.386 Sq Miles

### CUBIC MEASURE

1 Cu Centimeter=1000 Cu Millimeters=0.06 Cu Inches  
 1 Cu Meter=1,000,000 Cu Centimeters=35.31 Cu Feet

### TEMPERATURE

$5/9 (^{\circ}\text{F} - 32) = ^{\circ}\text{C}$   
 122° Fahrenheit is equivalent to 50° Celsius  
 90° Fahrenheit is equivalent to 32.2° Celsius  
 32° Fahrenheit is equivalent to 0° Celsius  
 $9/5 \text{ C}^{\circ} + 32 = \text{F}^{\circ}$

### APPROXIMATE CONVERSION FACTORS

<u>TO CHANGE</u>	<u>TO</u>	<u>MULTIPLY BY</u>
Inches.....	Centimeters.....	2.540
Feet.....	Meters.....	0.305
Yards.....	Meters.....	0.914
Miles.....	Kilometers.....	1.609
Square Inches.....	Square Centimeters.....	6.451
Square Feet.....	Square Meters.....	0.093
Square Yards.....	Square Meters.....	0.836
Square Miles.....	Square Kilometers.....	2.590
Acres.....	Square Hectometers.....	0.405
Cubic Feet.....	Cubic Meters.....	0.028
Cubic Yards.....	Cubic Meters.....	0.765
Fluid Ounces.....	Milliliters.....	29.573
Pints.....	Liters.....	0.473
Quarts.....	Liters.....	0.946
Gallons.....	Liters.....	3.785
Ounces.....	Grams.....	28.349
Pounds.....	Kilograms.....	0.454
Short Tons.....	Metric Tons.....	0.907
Pound-Feet.....	Newton-Meters.....	1.356
Pounds/Sq Inch.....	Kilopascals.....	6.895
Miles per Gallon.....	Kilometers per Liter.....	0.425
Miles per Hour.....	Kilometers per Hour.....	1.609

<u>TO CHANGE</u>	<u>TO</u>	<u>MULTIPLY BY</u>
Centimeters.....	Inches.....	0.394
Meters.....	Feet.....	3.280
Meters.....	Yards.....	1.094
Kilometers.....	Miles.....	0.621
Sq Centimeters.....	Square Inches.....	0.155
Square Meters.....	Square Feet.....	10.764
Square Meters.....	Square Yards.....	1.196
Square Kilometers.....	Square Miles.....	0.386
Sq Hectometers.....	Acres.....	2.471
Cubic Meters.....	Cubic Feet.....	35.315
Cubic Meters.....	Cubic Yards.....	1.308
Milliliters.....	Fluid Ounces.....	0.034
Liters.....	Pints.....	2.113
Liters.....	Quarts.....	1.057
Liters.....	Gallons.....	0.264
Grams.....	Ounces.....	0.035
Kilograms.....	Pounds.....	2.205
Metric Tons.....	Short Tons.....	1.102
Newton-Meters.....	Pound-Feet.....	0.738
Kilopascals.....	Pounds per Sq Inch.....	0.145
Km per Liter.....	Miles per Gallon.....	2.354
Km per Hour.....	Miles per Hour.....	0.621

