

TM 9-719

DEPARTMENT OF THE ARMY TECHNICAL MANUAL

TANK MOUNTING BULLDOZER M1 AND M1A1

DEPARTMENT OF THE ARMY • AUGUST 1948

DEPARTMENT OF THE ARMY TECHNICAL MANUAL
T M 9-719

*This manual supersedes all editions of TM 5-1310 including changes thereto;
TB ENG 9, 1 March 1944; TB ENG 23, 17 May 1944; and
TB ENG 41, 20 September 1944*

TANK MOUNTING BULLDOZER M1 AND M1A1



DEPARTMENT OF THE ARMY • AUGUST 1948

*United States Government Printing Office
Washington: 1948*

DEPARTMENT OF THE ARMY
Washington 25, D.C., 10 August 1948

TM 9-719, Tank Mounting Bulldozer M1 and M1A1, is published for the information and guidance of all concerned.

[AG 300.7 (21 Nov 45)]

BY ORDER OF THE SECRETARY OF THE ARMY:

OFFICIAL:

OMAR N. BRADLEY

Chief of Staff, United States Army

EDWARD F. WITSELL

Major General

The Adjutant General

DISTRIBUTION:

Army:

Tech Sv (2); Arm & Sv Bd (1); AFF (5); OS Maj Comd (10); Base Comd (2); MDW (5); A (ZI) (18), (Overseas) (3); CHQ (2); D (2); FC (1); Class II Instls 9 (3); USMA (2); Sch (5); Tng Ctr (2); PE (Ord O) (5); one (1) copy to each of the following T/O & E's: 9-7; 9-9; 9-12; 9-57; 9-65; 9-67; 9-76; 9-127; 9-197; 9-316; 9-317; 9-377; 17-27; SPECIAL DISTRIBUTION.

Air Force:

USAF (5).

For explanation of distribution formula see TM 38-405.

CONTENTS

PART ONE. INTRODUCTION.

<i>Section</i>		<i>Paragraphs</i>	<i>Page</i>
	<i>I.</i> General	1- 2	1
	<i>II.</i> Description and data	3- 4	3

PART TWO. OPERATING INSTRUCTIONS.

<i>Section</i>	<i>III.</i> General	5	9
	<i>IV.</i> Service upon receipt of equipment	6-13	9
	<i>V.</i> Controls and operation	17-19	41
	<i>VI.</i> Operation under unusual conditions	20-21	43
	<i>VII.</i> Demolition to prevent enemy use	22-23	43

PART THREE. MAINTENANCE INSTRUCTIONS

<i>Section</i>	<i>VIII.</i> General	24	45
	<i>IX.</i> Organizational spare parts, tools, and equipment	25-26	45
	<i>X.</i> Lubrication	27-29	45
	<i>XI.</i> Preventive maintenance services	30-36	48
	<i>XII.</i> Trouble shooting	37-41	56
	<i>XIII.</i> Blade, tripod, and suspension mounting brackets	42-49	57
	<i>XIV.</i> Jack supporting group and pipe guard	50-54	64
	<i>XV.</i> Hydraulic system	55-61	68

PART FOUR. AUXILIARY EQUIPMENT

<i>Section</i>	<i>XVI.</i> General	62	75
----------------	---------------------------	----	----

PART FIVE. REPAIR INSTRUCTIONS.

<i>Section</i>	<i>XVII.</i> General	63	76
	<i>XVIII.</i> Special tools	64	76
	<i>XIX.</i> Miscellaneous parts	65-66	76
	<i>XX.</i> Hydraulic pump	67-70	80
	<i>XXI.</i> Control valve	71-74	88
	<i>XXII.</i> Hydraulic jack	75-76	91
	<i>XXIII.</i> Serviceability standards	77	96

APPENDIX I. SHIPMENT AND LIMITED STORAGE	98
---	-----------

APPENDIX II. REFERENCES	101
--------------------------------------	------------

INDEX	103
--------------------	------------

This manual supersedes all editions of TM 5-1310 including changes thereto; TB ENG 9, 1 March 1944; TB ENG 23, 17 May 1944; and TB ENG 41, 20 September 1944

PART ONE

INTRODUCTION

Section I. GENERAL

1. Scope

a. These instructions are published for the information and guidance of all concerned. They contain information on operation and maintenance of the equipment as well as description of major units and their functions in relation to other components of this bulldozer. They apply only to the bulldozers M1 and M1A1 and are arranged in five parts: Part One, Introduction; Part Two, Operating Instructions; Part Three, Maintenance Instructions; Part Four, Auxiliary Equipment; and Part Five, Repair Instructions.

b. The appendixes at the end of the manual contain instructions for shipment and limited storage, and a list of references including standard nomenclature lists, technical manuals, and other publications applicable to the bulldozer.

c. The stock and part numbers which appear throughout the manual are extracted from Army Supply Catalog ORD 7-8 SNL G-228.

d. This manual does not contain information on the operation and maintenance of the tanks since such information is available in the manual on the respective tank employed.

2. Records

a. GENERAL. Forms, records, and reports are designed to serve necessary and useful purposes. Responsibility for the proper execution of these forms rests upon commanding officers of all units operating and maintaining vehicles. It is emphasized, however, that forms, records, and reports are merely aids. They are not substitutes for thorough, practical work, physical inspection, and active supervision.

b. AUTHORIZED FORMS. The forms, records, and reports generally applicable to units operating and maintaining this matériel are listed below with brief explanations of each. Reference should also be made to the pertinent manual on the respective tank employed with this matériel. No forms other than approved Department of the Army forms will be used in operating and maintaining the vehicles.

Pending availability of forms listed, old forms may be used. For a current and complete listing of all forms, see the current FM 21-6.

(1) *Lubrication order.* Lubrication Order LO 9-719 prescribes lubrication maintenance for this matériel. A lubrication order is issued with each vehicle and is to be carried with it at all times. Instructions contained therein are mandatory to all users of the equipment and supersede all conflicting lubrication instructions of prior date.

(2) *WD AGO Form 9-71, Locator and Inventory Control Card.* Except when specified otherwise by the Department of the Army, this form will be used as a bin tag, locator card, or inventory control card by all units authorized automotive spare parts.

(3) *WD AGO Form 9-74, Motor Vehicle Operator's Permit.* This form will be issued by commanders to all operators of vehicles who are qualified to operate the particular vehicles noted on the permit.

(4) *WD AGO Form 9-76, Request for Work Order.* This form will be used for requesting repairs, alterations, or other type of work within or between organizations and departments.

(5) *WD AGO Form 9-77, Job Order Register.* This form will be used to keep a chronological record of work orders.

(6) *WD AGO Form 460, Preventive Maintenance Roster.* This form will be used for scheduling and maintaining a record of motor vehicle maintenance operations (weekly, monthly, quarterly, and semiannually).

(7) *WD AGO Form 468, Unsatisfactory Equipment Report.* This form will be used for reporting manufacturing design, or operational defects in this matériel, with all pertinent information necessary to initiate corrective action. The report should be forwarded to Chief of Ordnance, Field Service Division, Maintenance Branch, through command channels, in accordance with instruction 7 on the form. Such suggestions are encouraged in order that other organizations may benefit.

(8) *WD AGO Form 478, Modification Work Order and Major Unit Assembly Replacement Record and Organization Equipment File.* This form will be kept in possession of organizational maintenance personnel and will accompany vehicles upon transfer and evacuation to higher maintenance levels. It will be a record of all modifications made and exchanges of major unit assemblies. Minor repairs, parts, and accessory replacements will not be recorded. In the field, where no filing facilities are available, this form will be kept in a filing jacket.

(9) *WD AGO Form 811, Work Request and Job Order.* This form will be used by organizational maintenance units when requesting repair by a higher echelon repair unit.

(10) *WD AGO Form 811-1, Work Request and Hand Receipt.* This form is issued as a set with WD AGO Form 811. It is a receipt

for items turned in for repair and will be retained until items are returned.

Section II. DESCRIPTION AND DATA

3. Description

a. GENERAL. The bulldozers M1 and M1A1 (figs. 1, 2, and 3) are mounted on medium tank M4 series and each consists primarily of a large blade with an extended arm at each end. The bulldozer blade is pivoted on the mounting brackets which are fastened to the outside of the suspension. A tripod arrangement is attached on the back of the blade connecting the telescope hydraulic jack and the bulldozer blade (fig. 4). The tripod connects the blade to the hydraulic jack and incloses the jettisoning cable arrangement. The hydraulic jack is attached to the front of the tank. Power for operating the blade is provided by a hydraulic pump mounted on the transmission case of the tank and driven by two belts, which receive their power from the tank propeller shaft (figs. 5 and 6). The oil in the hydraulic jack is controlled by the control valve on the oil reservoir. The control valve is operated manually, providing the oil supply necessary for operation of the bulldozer blade.

b. DIFFERENCE BETWEEN BULLDOZERS M1 AND M1A1. Bulldozers M1 and M1A1 are similar except that the blade of the M1A1 is 14 inches wider than that of the M1. The bulldozer M1 is mounted on the standard vertical suspension of the medium tank M4 series. The bulldozer is mounted on the standard vertical, spaced vertical, and horizontal suspensions. The bulldozer M1A1 has a 3-section telescopic jack, whereas the bulldozer M1 has a 1-section telescopic jack.

4. Data

Height of blade -----	48 in.
Over-all width:	
M1 -----	124 in.
M1A1 -----	138 in.
Adds to vehicle weight:	
M1 -----	7,100 lb.
M1A1 -----	7,400 lb.
Lift height of blade:	
M1 -----	1 ft. 6 in. to 2 ft. 6 in.
M1A1 -----	1 ft. 6 in. to 3 ft. 6 in.
Lift load (on blade):	
M1 -----	4,000 lb.
M1A1 -----	5,000 lb.

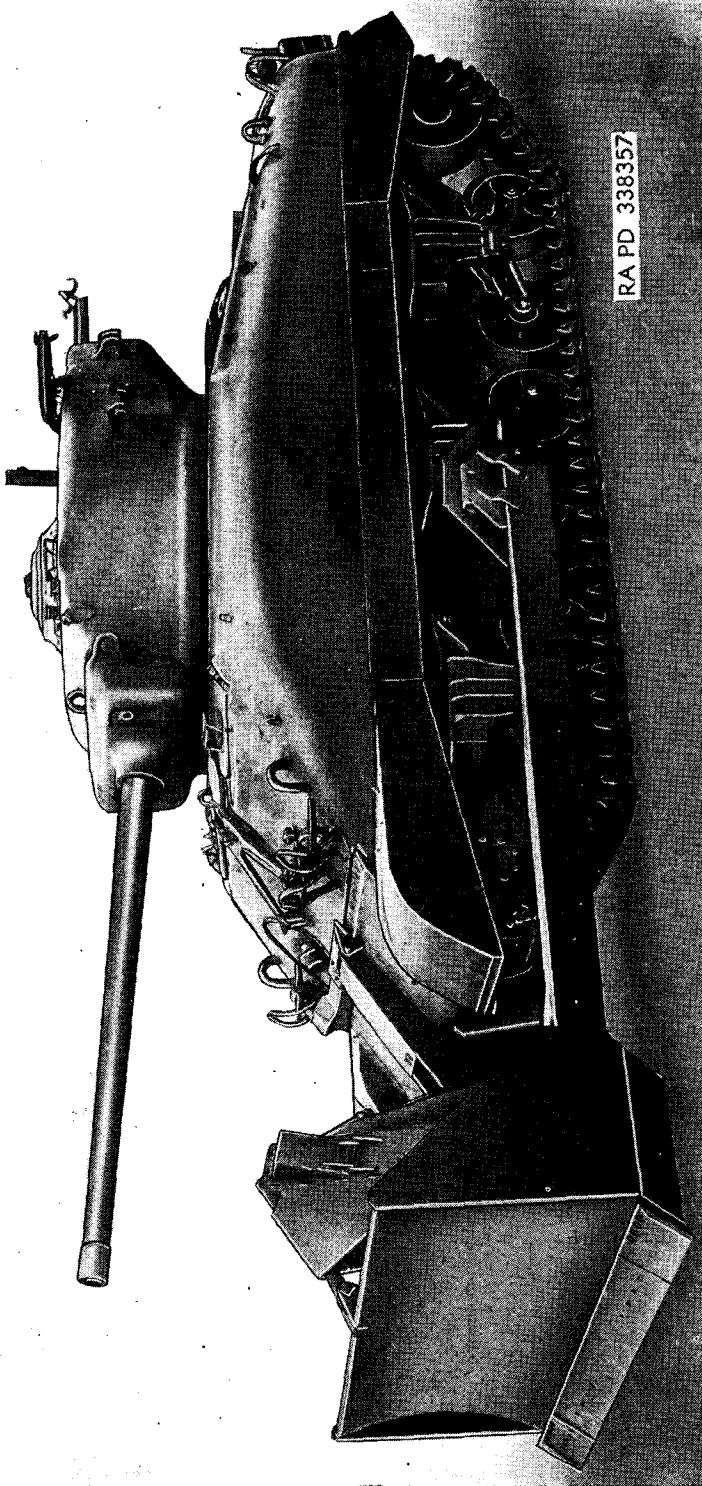
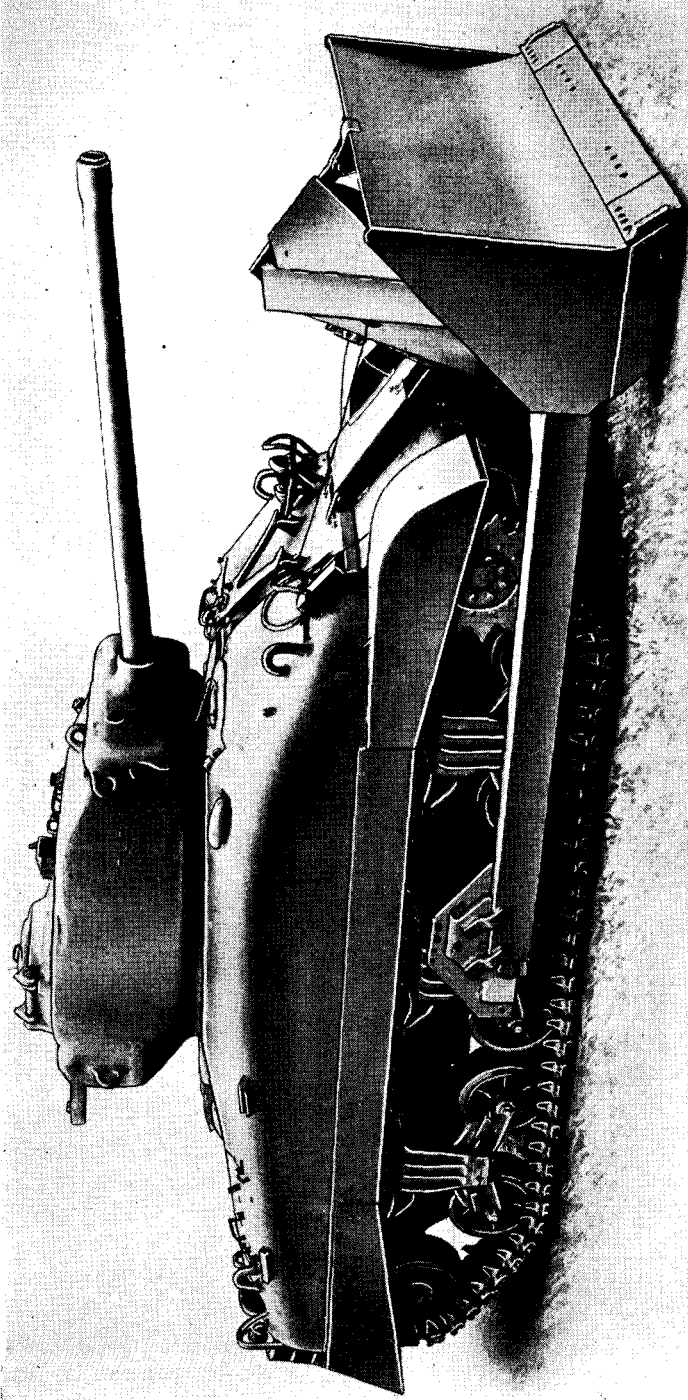
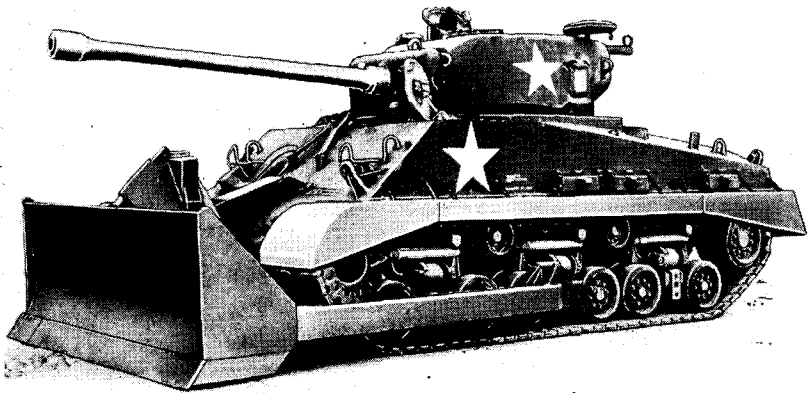

Figure 1. Bulldozer M1 mounted on medium tank M4A1 (standard vertical suspension)—left side.



RA PD 338358

Figure 2. Bulldozer M1 mounted on medium tank M4A1 (standard vertical suspension)—right side.



RA PD 338362

*Figure 3. Bulldozer M1A1 mounted on medium tank M4A3
(horizontal suspension).*

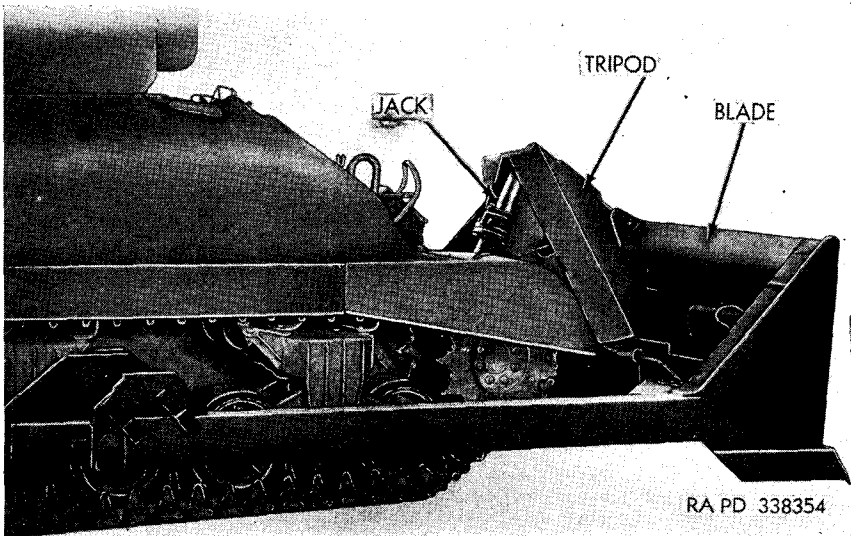

RA PD 338354

Figure 4. Bulldozer M1 mounted on medium tank M4A1.

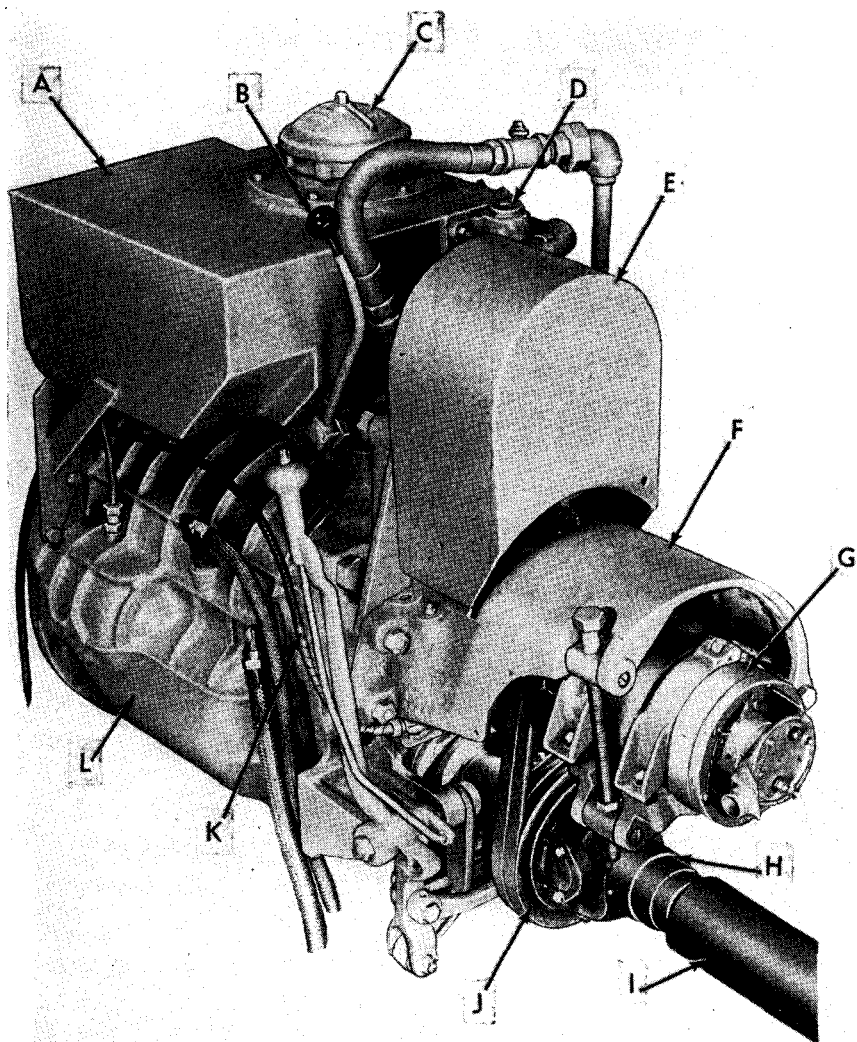

A-OIL RESERVOIR
B-CONTROL LEVER
C-BREATHER AND FILLER CAP
D-CONTROL VALVE
E-PUMP DRIVING BELT GUARD
F-GENERATOR CRADLE BRACKET

G-GENERATOR
H-UNIVERSAL JOINT
I-PROPELLER SHAFT
J-GENERATOR DRIVE PULLEY
K-TACHOMETER CABLE
L-TRANSMISSION

RA PD 338557A

Figure 5. Bulldozer hydraulic group mounted in late model M4 series tank—left side.

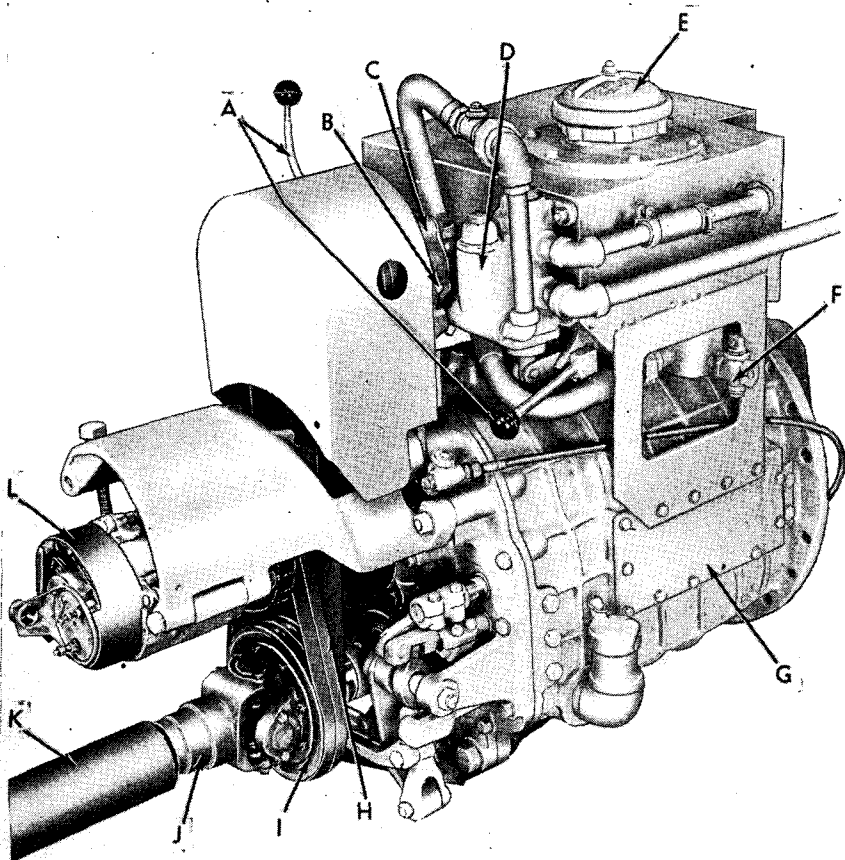

- A—CONTROL LEVER
- B—PUMP DRIVING BELT ADJUSTING SCREW
- C—PUMP
- D—CONTROL VALVE
- E—BREATHER AND FILLER CAP
- F—OIL RESERVOIR SHUT-OFF COCK (DRAIN)
- G—TRANSMISSION INSPECTION HOLE COVER
- H—PUMP DRIVING BELTS
- I—GENERATOR DRIVE PULLEY
- J—UNIVERSAL JOINT
- K—PROPELLER SHAFT
- L—GENERATOR

RA PD 338556A

Figure 6. Bulldozer hydraulic group mounted in late model M4 series tank—right side.

PART TWO

OPERATING INSTRUCTIONS

Section III. GENERAL

5. Scope

Part two contains information for guidance of personnel responsible for operation of this equipment. It contains information on operation of equipment with description and location of the controls.

Section IV. SERVICE UPON RECEIPT OF EQUIPMENT

6. Scope

a. The instructions covered in all but the last three paragraphs in this section (pars. 14, 15, and 16) are for the information and guidance of personnel charged with the unpacking of the crate containing two bulldozers (M1 or M1A1) and attaching same to M4 series tank.

b. The last three paragraphs in this section (pars. 14, 15, and 16) cover service on bulldozer M1 or M1A1 after it has been mounted on a vehicle or when it is received already attached to the vehicle.

c. New bulldozers are received crated. It is necessary for the using organization to uncrate the bulldozer and attachments from the crate (par. 7). Instructions on installation of bulldozer attachments on the tank are given in paragraphs 8 through 13.

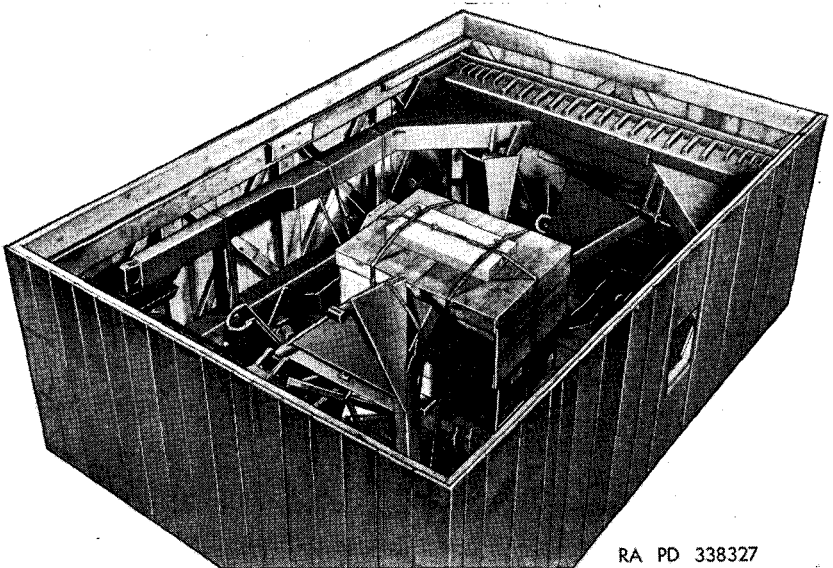

RA PD 338327

Figure 7. Bulldozer in crate with cover removed.

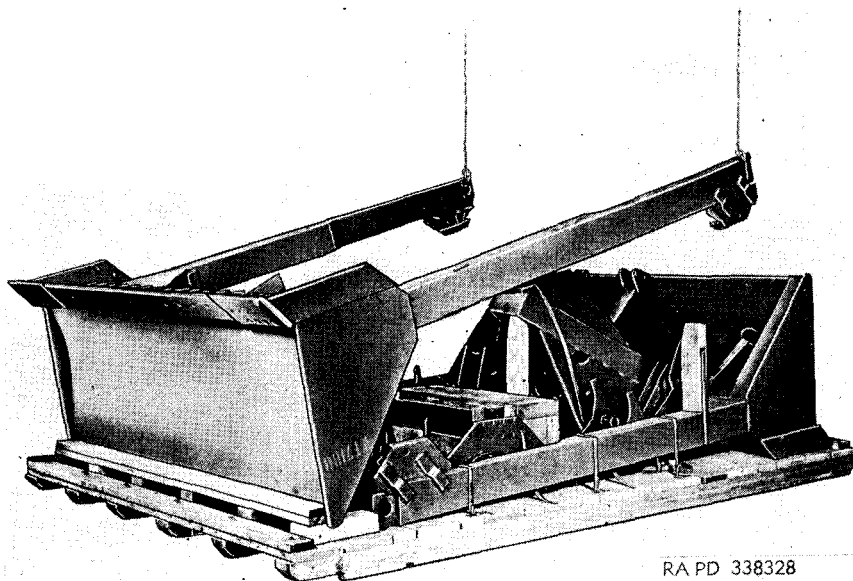

RA PD 338328

Figure 8. Bulldozer M1—removing upper bulldozer from crate.

7. Unpacking Crated Bulldozer and Parts Identification

a. UNPACK CRATED BULLDOZER. New bulldozers (including spare parts and tools) are packed two in one crate (fig. 7). First, cut all the metal straps, then raise and remove cover and pry away the sides of the crate. Cut the metal straps securing the equipment to the base of crate or skid. Remove the upper bulldozer blade from its position in crate by raising it at the sidearm ends (fig. 8), pivoting it on the blade until the sidearm ends rest on the other side on the ground. Before the sidearms are fully raised, connect the tripod at the top to the blade with a connecting pin. Two eyebolts in the back of the blade are provided for lifting. Remove the remaining parts and separate all the material into two complete bulldozer sets.

b. CONTENTS OF CRATE (FOR TWO COMPLETE BULLDOZERS (M1 OR M1A1)). (1) *External parts (M1)* (fig. 10).

<i>Item</i>	<i>Quantity in crate</i>	<i>Key letter</i>
Angle support -----	4	F
Blade and tripod -----	2	A
Hydraulic jack assembly -----	2	D
Jack hose -----	2	E
Jack piping -----	2	H
Jack support frame (for tank w/narrow towing span) -----	2	C
Jack support frame (for tank w/wide towing span) -----	2	B
Lower pipe guard -----	2	J
RH and LH suspension mounting brackets -----	4	K
Suspension bracket cap -----	4	G
Upper pipe guard -----	2	I

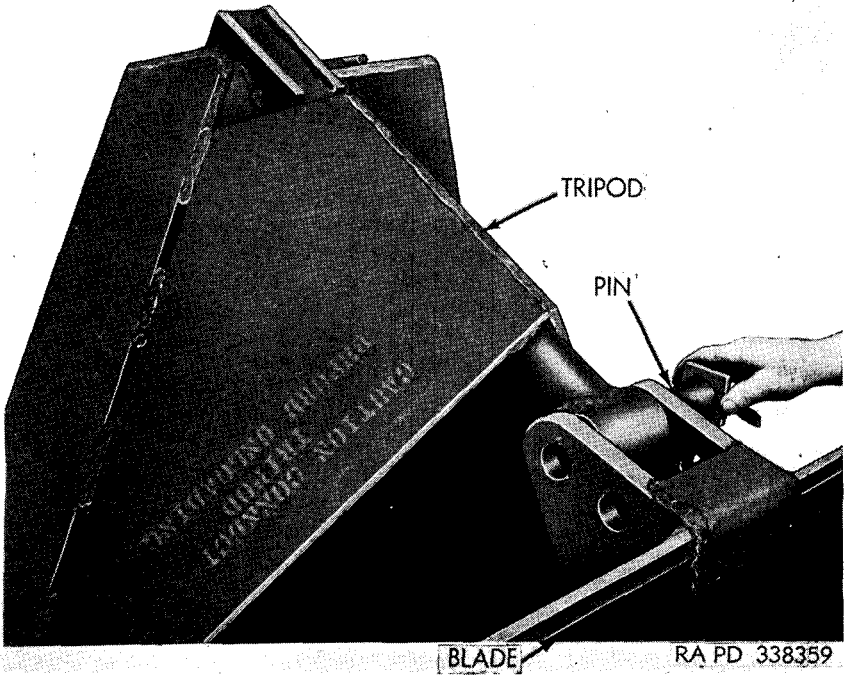

Figure 9. Attaching tripod to blade at upper connecting pin.

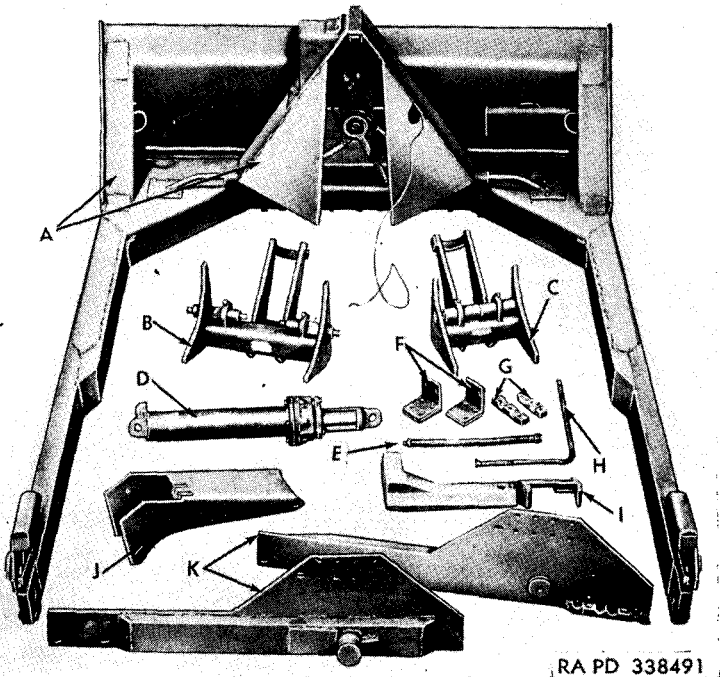

Figure 10. External parts for tank mounting bulldozer M1.

(2) *External parts (M1A1) (fig. 11).*

<i>Item</i>	<i>Quantity in crate</i>	<i>Key letter</i>
Adapter pivots (spaced vertical suspension) -----	4	L
Adapter pivots (standard vertical suspension) -----	4	N
Angle supports -----	4	I
Blade and tripod -----	2	A
Hydraulic jack assembly -----	2	D
Jack hose -----	2	H
Jack piping -----	2	G
Jack side support (for tank w/narrow towing span) -----	2	B
Jack side support (for tank w/wide towing span) -----	2	C
Jack support -----	2	J
LH and RH horizontal suspension mounting brackets -----	2	M
LH and RH vertical suspension mounting brackets -----	2	K
Pipe guard -----	2	E
Suspension bracket caps -----	4	F

(3) *Internal parts (M1 and M1A1) (fig. 12).*

<i>Item</i>	<i>Quantity in crate</i>	<i>Key letter</i>
Bag of bolts -----	2	G
Bag of pipe fittings -----	2	H
Hydraulic pump driving belts (V type) -----	4	E
Jack to control valve pipe -----	2	F
Oil reservoir assembly -----	2	D
Pressure control valve assembly -----	2	C
Pressure pump assembly and bracket -----	2	A
Pump belt guard -----	2	B
Pump drive flange -----	2	K
Set of three hoses -----	2	I
Two control valve gaskets -----	2	J

(4) *Tools in crate (M1A1 only).* Each bulldozer M1A1 crate contains two high-pressure hydraulic gages (par. 56 and fig. 13).

8. Assembly of Bulldozer on the Tank

a. Any medium tank model of the M4 series M4A1, M4A2, M4A3 may be used to mount a bulldozer blade. The bulldozer M1 can be mounted on the standard vertical suspension tank only; the bulldozer M1A1 may be mounted on the standard vertical suspension, spaced vertical suspension, or the horizontal suspension tanks of the M4 series. The tank selected should be properly serviced and in good operating condition.

b. The following instructions divide the installation operation into five groups (pars. 9 through 13) according to the function of various parts. Work on each group may proceed simultaneously except that the bulldozer blade group (par. 12) should be installed last.

9. Installation of Hydraulic Group within the Tank

a. REMOVE INTERFERING OBJECTS MOUNTED ON TRANSMISSION. Remove tray or periscope head box (fig. 14), which is secured to the

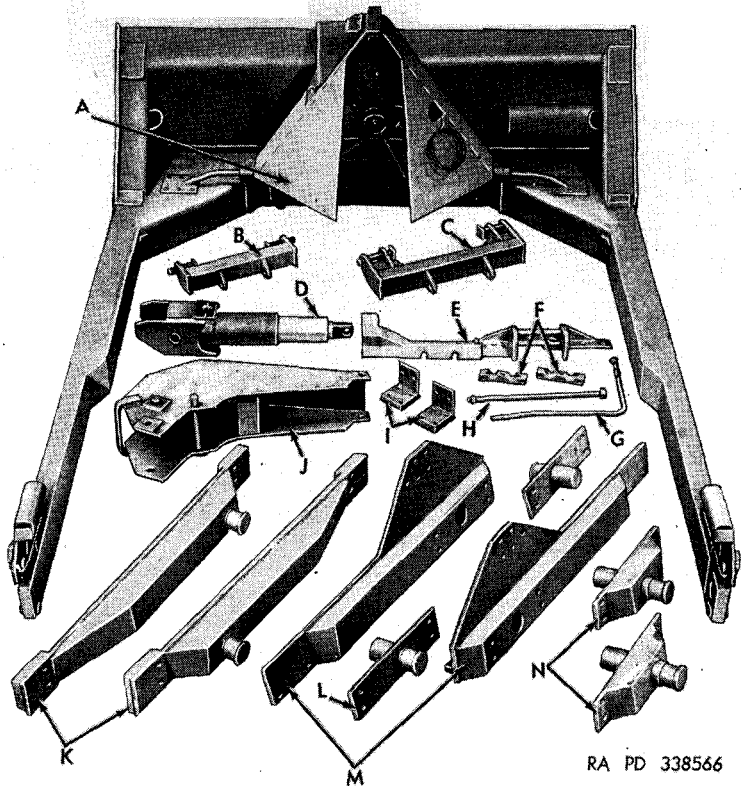

RA PD 338566

Figure 11. External parts for tank mounting bulldozer M1A1.

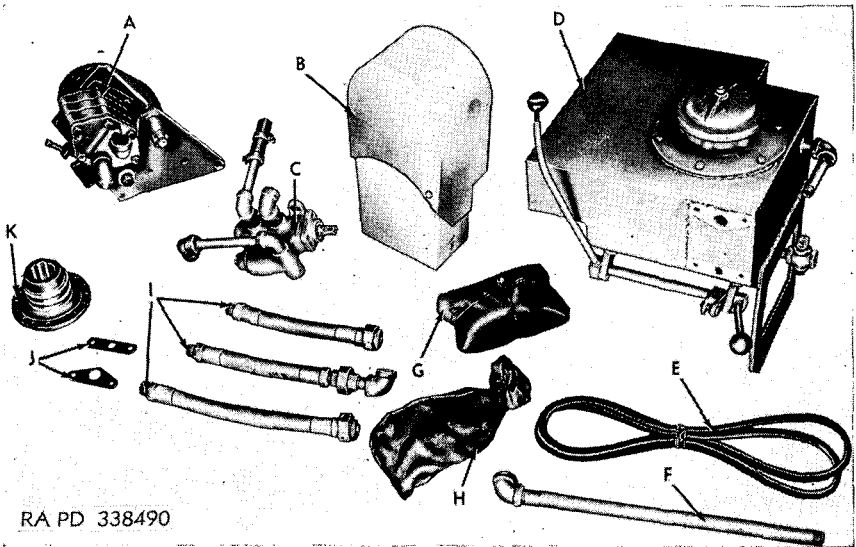

RA PD 338490

Figure 12. Internal parts for tank mounting bulldozer M1 or M1A1.

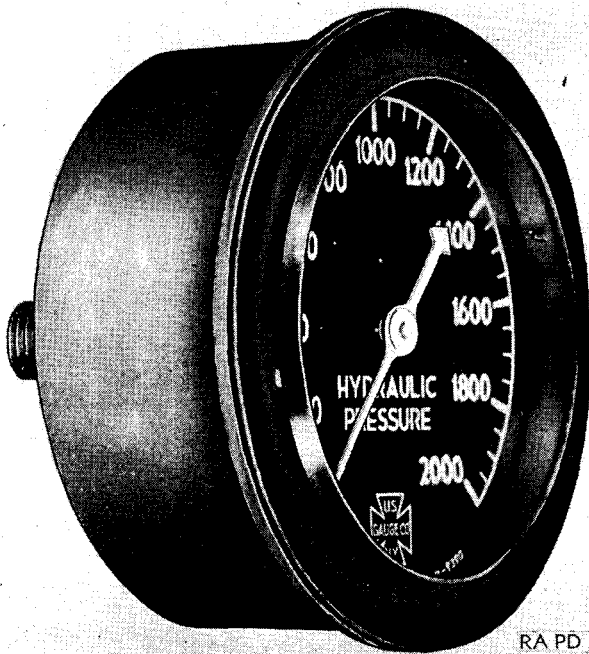

RA PD 338586A

Figure 13. High-pressure hydraulic gage (B182562) (bulldozer M1A1 only).

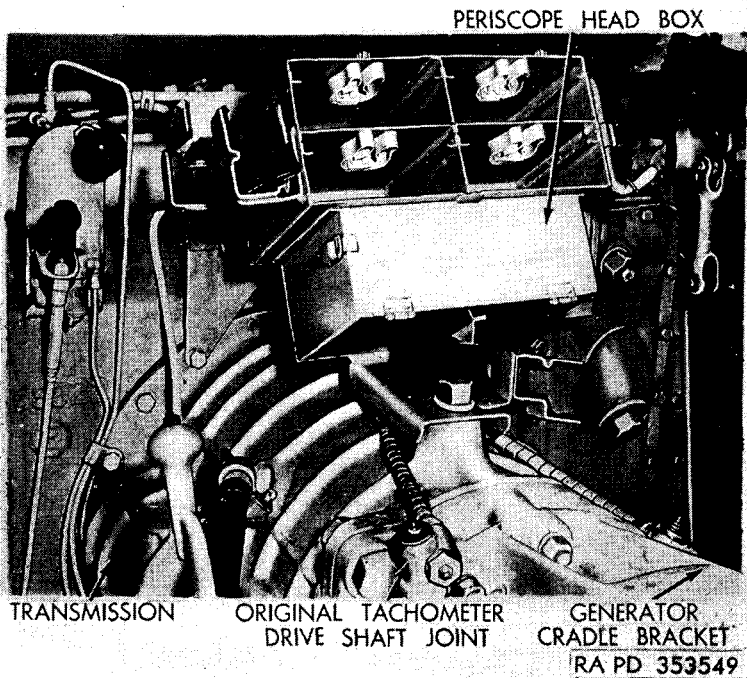

Figure 14. Periscope head box.

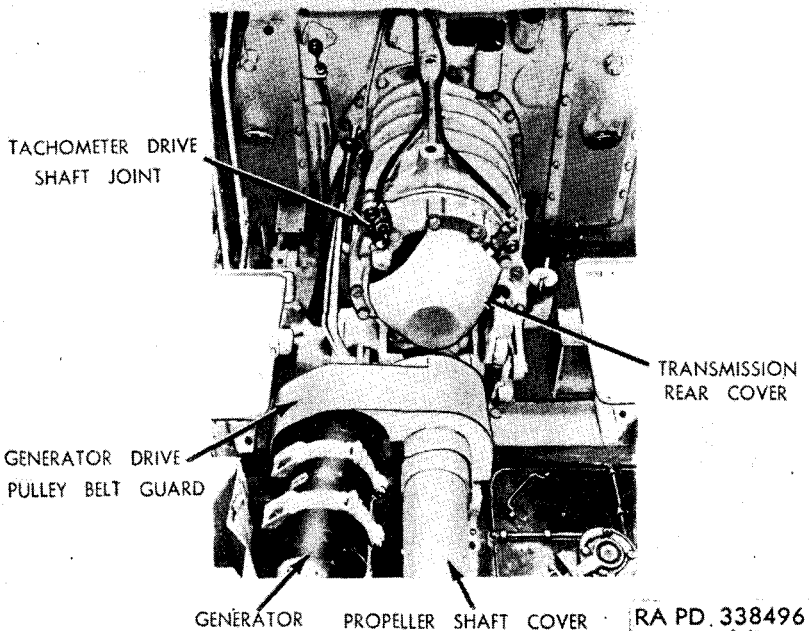

Figure 15. Generator mounted alongside of propeller shaft in early model M4 series tank.

top of the transmission. This is removed to make room for the oil reservoir. Tray or periscope head box will not be reinstalled.

b. REMOVE TACHOMETER DRIVE SHAFT JOINT. If tank is equipped with a tachometer drive shaft joint connected at rear of transmission (figs. 14 and 15), disconnect and remove the tachometer drive shaft joint and drive key (fig. 16). This joint and key will not be reinstalled. Remove the tachometer drive shaft through the drive shaft sleeve.

c. REMOVE PROPELLER SHAFT HOUSING. (1) If tank is equipped with a generator mounted on or near the engine, remove propeller shaft housing. Take off the sheet steel transmission cover fastened to the rear of transmission. The transmission rear cover will not be reinstalled.

(2) If tank is equipped with a generator mounted at the side of the propeller shaft (fig. 14), loosen the generator belt adjustment and remove belts from generator pulley. Remove the propeller shaft housing at the transmission end. Take off the sheet steel transmission cover fastened to the rear of transmission. This cover will not be reinstalled.

d. REMOVE GENERATOR AND GENERATOR CRADLE BRACKET (fig. 5). If tank is equipped with a generator mounted above the drive pulley, remove guard from each side of generator cradle bracket. Discon-

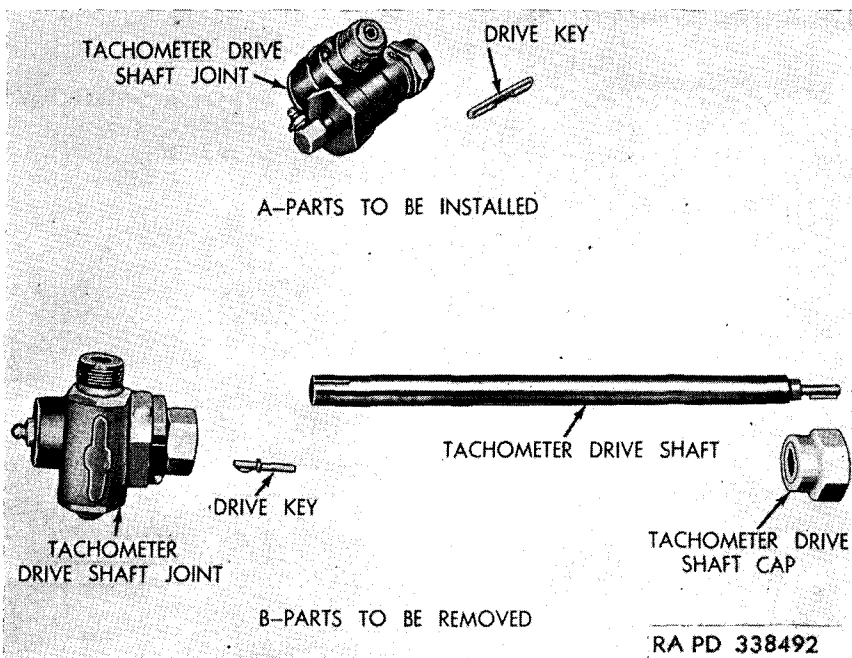

Figure 16. Tachometer drive shaft joints.

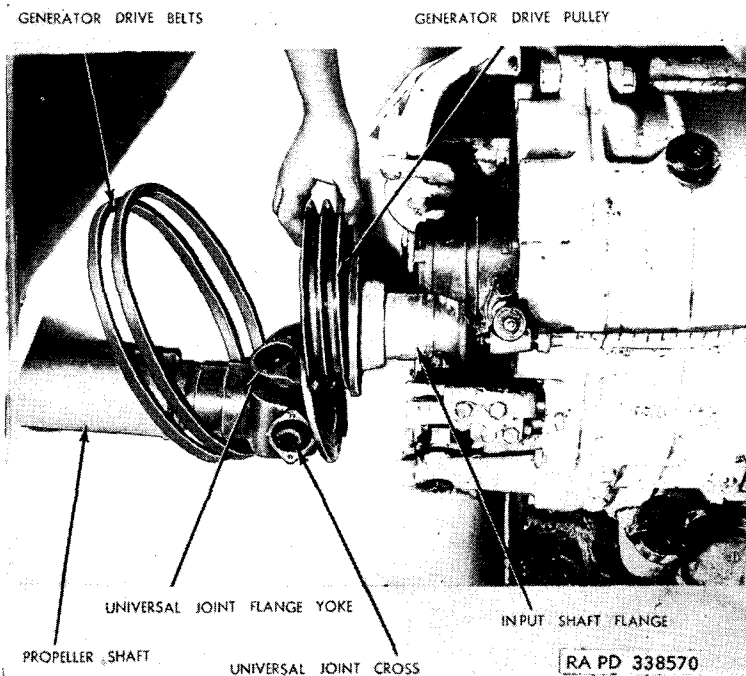
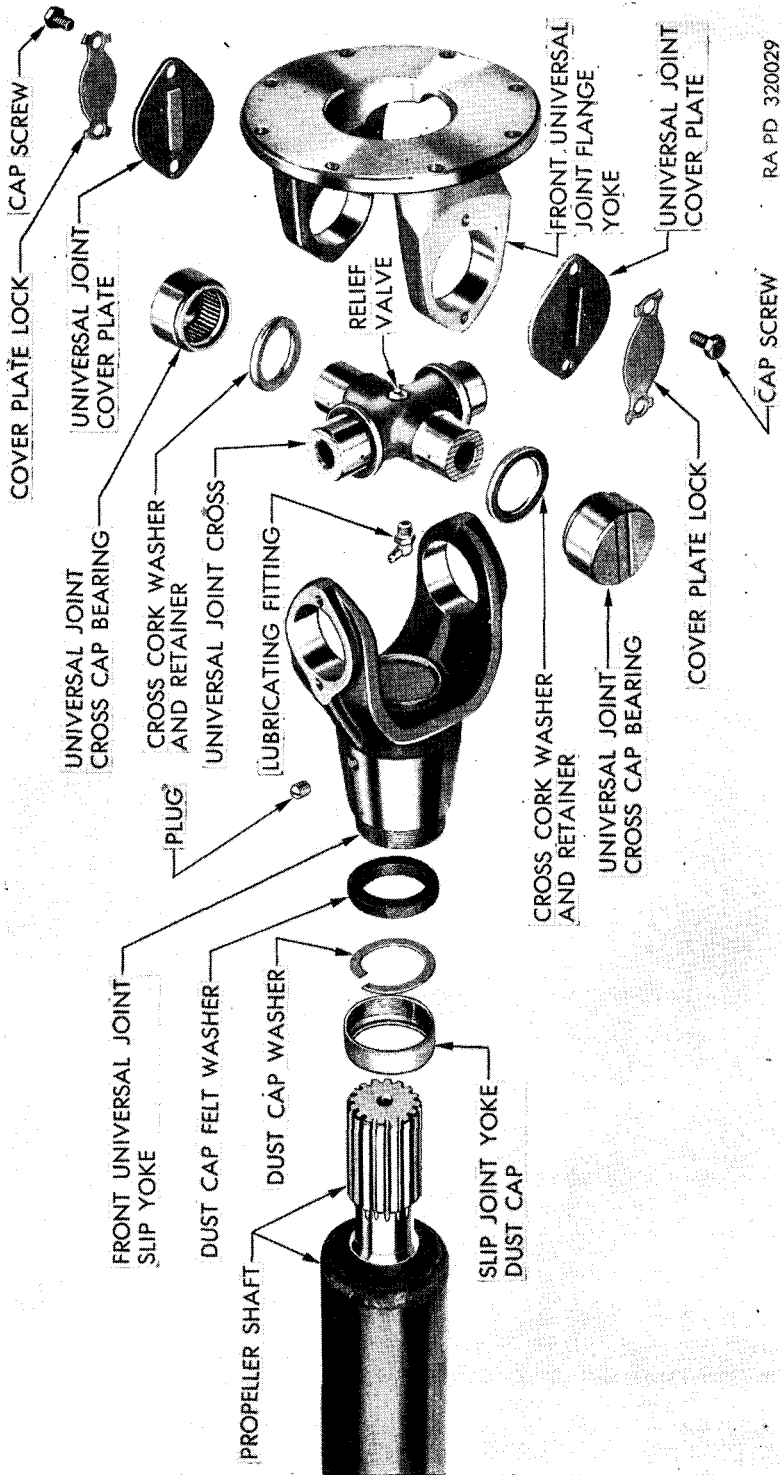

Figure 17. Removing generator drive pulley.



RA PD 320029

Figure 18. Universal joint—disassembled.

nect two generator lead wires and identify for installation. Unscrew the conduit connector nut on the end of generator, and pull out the lead wires. Disconnect the ground wire at the generator. Loosen the belt adjusting screw and swing the generator up to relieve tension on drive belts. Remove belts from generator. Remove generator cradle bracket by removing nuts at front flange.

e. REMOVE GENERATOR DRIVE PULLEY (figs. 17 and 18). Remove nuts and bolts which fasten together the front universal joint flange yoke, generator drive pulley, and the companion flange on transmission. Remove all four cross-cap bearings from the front universal joint by first removing cap screws, lock, and cover plate; then push the cross toward the bearing to be removed, to force the bearing out of the yoke. In the same manner, push the cross toward the other bearings to be removed. Work the slip yoke back onto the propeller shaft, pulling the flange yoke out of the drive pulley. Tap the generator drive pulley off the companion flange on transmission. Raise and maneuver the universal joint to remove the pulley.

f. REMOVE TRANSMISSION INPUT SHAFT FLANGE (fig. 17). Remove nut from end of transmission shaft and slide the flange from shaft or pull it off with a gear puller.

g. INSTALL HYDRAULIC PUMP DRIVE FLANGE (fig. 19). Install pump drive flange from bulldozer kit on end of transmission shaft and secure with nut and cotter pin.

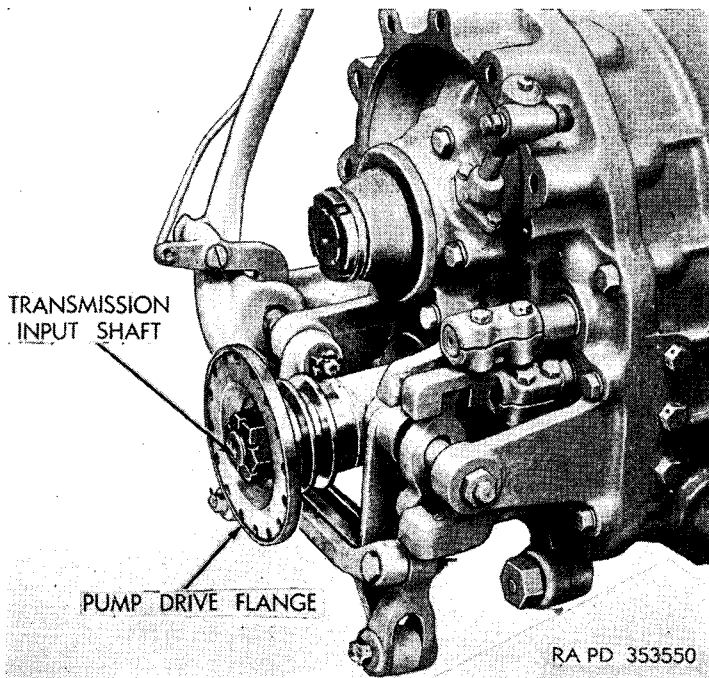

Figure 19. Pump drive flange—installed.

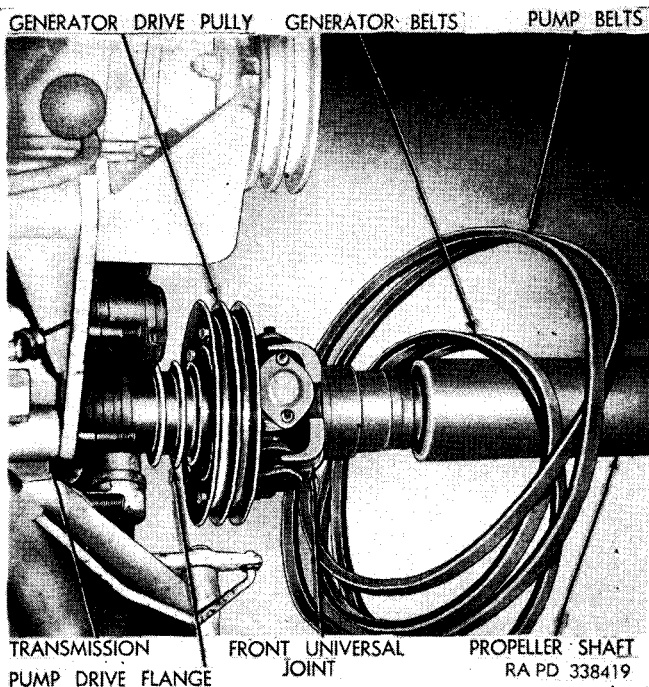

Figure 20. Generator drive pulley and pump drive flange—installed.

h. INSTALL GENERATOR DRIVE PULLEY (fig. 20). Place the two generator and two pump drive belts over the propeller shaft with the universal joint cross in place. Maneuver the universal joint flange yoke and install the generator drive pulley on the pump drive flange, with the counterbored groove toward the flange (fig. 17). Align the holes of universal joint flange yoke, generator drive pulley, and pump drive flange, and secure with bolts and nuts. Lock wire the nuts.

i. INSTALL THE NEW TACHOMETER DRIVE SHAFT JOINT (fig. 21). Pry the lock from the tachometer drive shaft cap and remove the cap. This cap becomes surplus to bulldozer installation. Install new drive key and tachometer drive shaft joint (fig. 16) on tachometer drive gear bearing sleeve and bend the lock against the tachometer drive shaft joint. Remove the clip holding the tachometer and speedometer cables at the front of the transmission and connect the tachometer cable to the tachometer drive shaft joint.

j. ALTER OIL RESERVOIR SUPPORT BRACKET. The oil reservoir support bracket may interfere with the oil line or the primer lines on some tank models. This may be remedied by disconnecting the interfering primer line and bending it to suit, and by altering the oil reservoir support bracket as shown in figure 22.

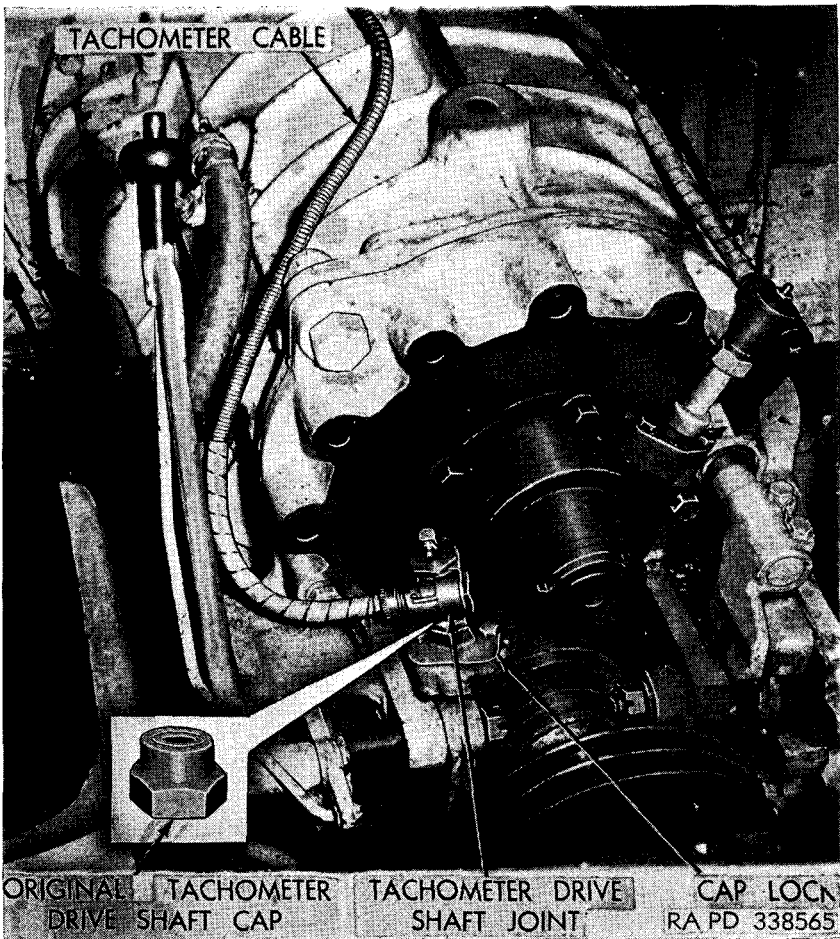

Figure 21. New tachometer drive shaft joint—installed.

k. **INSTALL OIL RESERVOIR.** Remove temporarily the entire filler tube assembly, held by six cap screws, from the oil reservoir (fig. 23). Lower the oil reservoir through the turret hatch in the turret, then place it in the driver's compartment. Mount the oil reservoir on the transmission, and secure it with the four top cap screws of transmission inspection hole cover on right side and the two front flange cap screws on the left side of transmission (figs. 5 and 6).

Caution: Make sure that the oil tube on transmission or primer line does not rub on the oil reservoir support bracket. Install the filler tube assembly and gasket on the oil reservoir at this time, and secure it with six cap screws and lock washers.

l. **INSTALL CONTROL VALVE** (fig. 23). Install the four control valve studs to the oil reservoir. Place the two control valve gaskets and the control valve over the studs and secure with lock washers and nuts. Connect the control valve to oil reservoir return line with

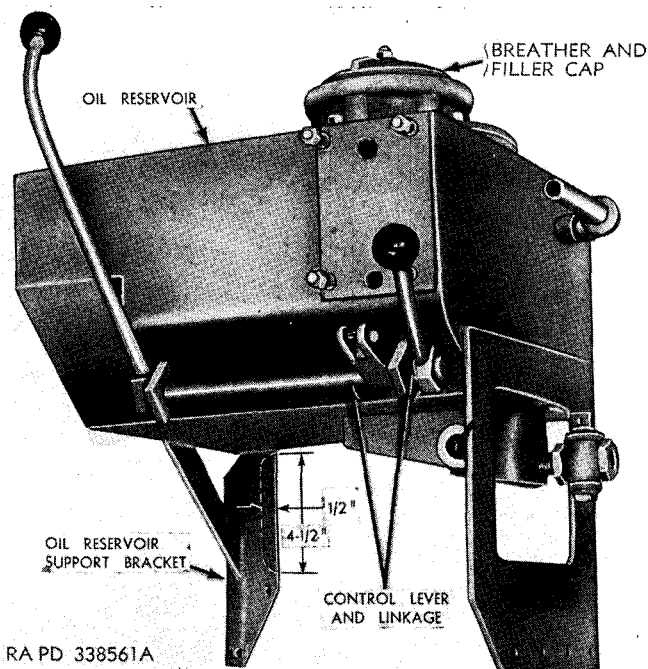

Figure 22. Alteration of oil reservoir support bracket.

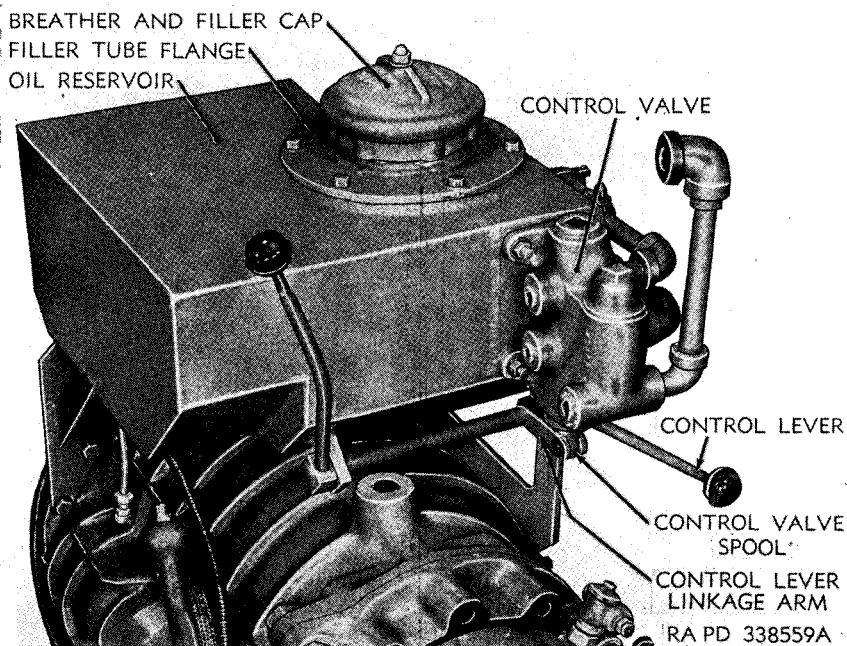

Figure 23. Control valve installed on reservoir.

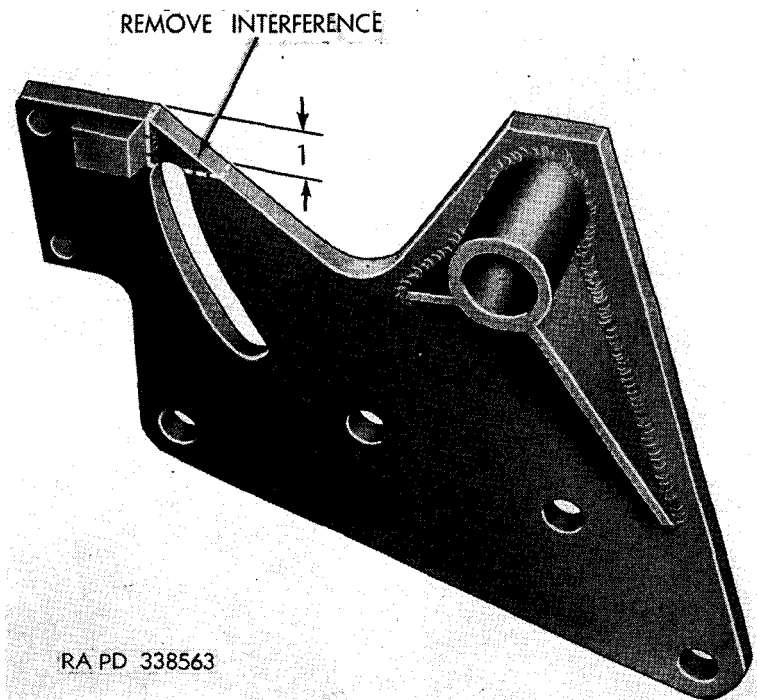

Figure 24. Alteration of hydraulic pump mounting plate.

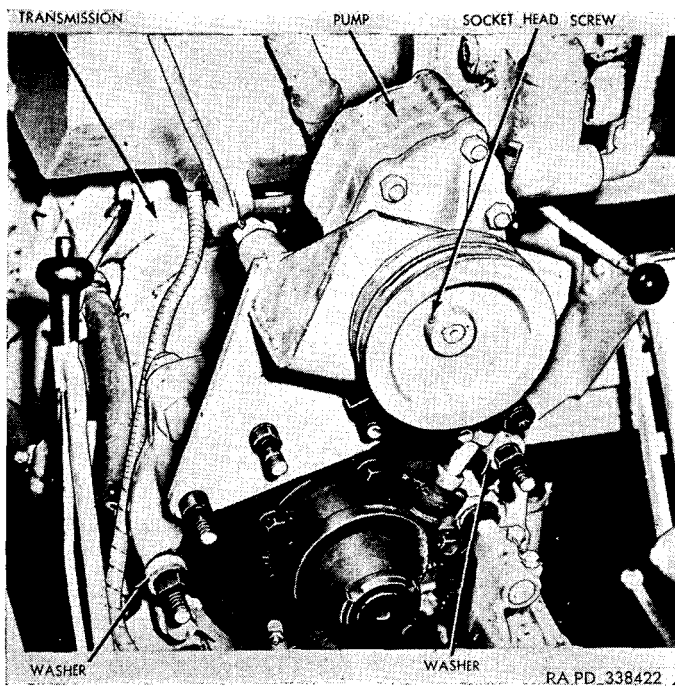
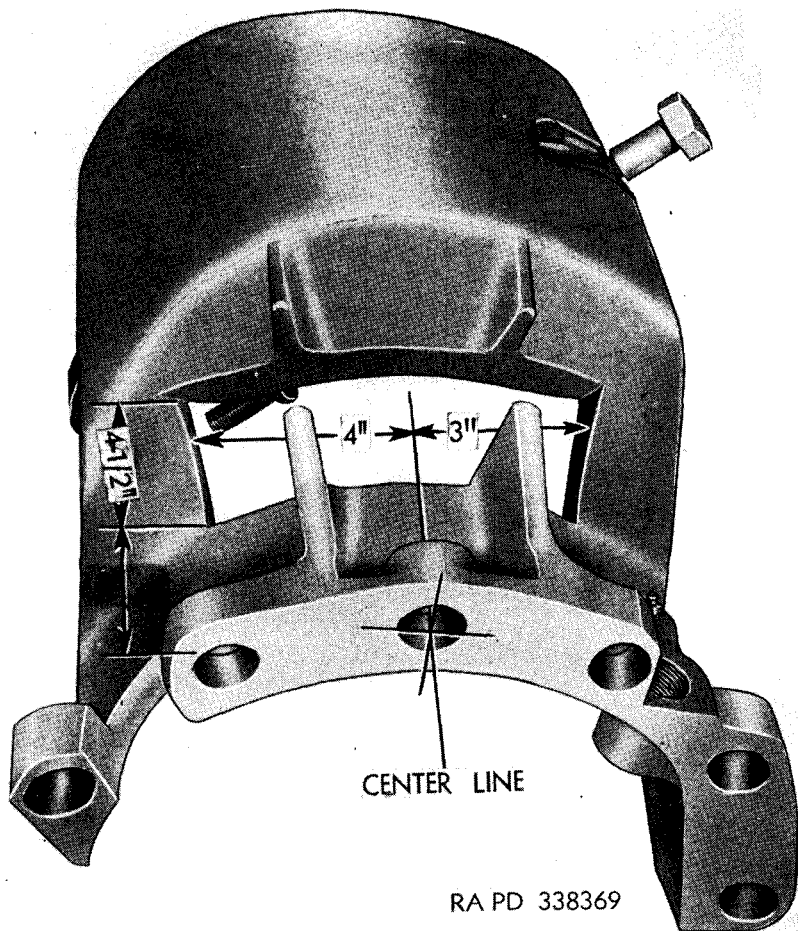

Figure 25. Pump fastened to transmission.



RA PD 338369

Figure 26. Alteration of generator cradle bracket.

the short hose and tighten the hose clamps. Install the pipe, elbow, and rubber hose to center elbow on control valve (fig. 6). Connect the control lever arm to the control valve spool with a pin and cotter pin.

m. ALTER PUMP MOUNTING PLATE. Alter the pump mounting plate (fig. 24) so that the pump can be adjusted to permit installation of pump drive belts.

n. INSTALL PUMP MOUNTING PLATE AND BRACKET (fig. 25). Install the two rubber hoses to the pump (fig. 6). Remove the six double end studs from rear of transmission and secure the pump to the transmission with the four top studs. Secure the 1/2-inch spacer washer from bulldozer kit to the transmission with the two remaining end studs. Connect the upper, or pressure discharge, hose to control valve and the lower, or suction, hose to bottom of reservoir.

o. ALTER GENERATOR CRADLE BRACKET (fig. 26). With an acetylene

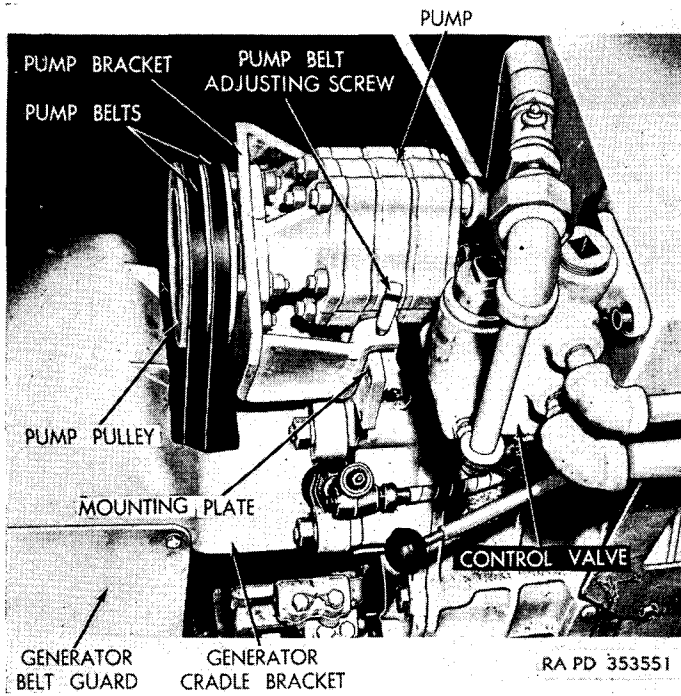

Figure 27. Hydraulic pump and control valve.

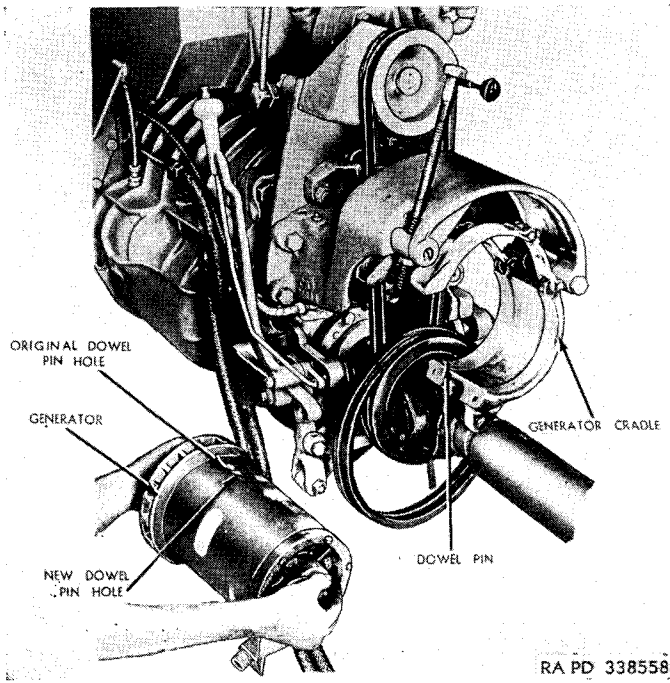

Figure 28. Installing generator.

torch or by drilling, cut a 2-inch by 7-inch slot in the generator cradle bracket for the hydraulic pump drive belts.

p. **INSTALL GENERATOR CRADLE BRACKET.** Place the altered generator cradle bracket over the double end studs on the transmission and secure with nuts and lock washers. Place belts in position on pump drive flange and pump pulleys (fig. 27).

Note. Make sure the belt opening in the generator cradle bracket is large enough to prevent belt interference.

q. **ADJUST TENSION OF PUMP DRIVE BELTS.** Loosen locking nut in pump bracket and turn the adjusting screw (fig. 27) until belts have 1-inch deflection. Tighten locking nut when tension is correct.

r. **ALTER GENERATOR FRAME.** Drill another dowel pin hole in the generator frame, one-half inch to the rear of original dowel pin hole (fig. 28).

s. **INSTALL GENERATOR** (fig. 28). Install generator from driver's side in the generator cradle, so that the dowel pin in cradle fits in the new dowel pin hole in generator frame, and so that the ground cable screw is on top. Fasten the cradle on the generator with two screws and thread the generator adjusting screw through the cradle hinge. Install the generator belts on pulleys and turn adjusting screw until belts have a 1/2-inch deflection. Tighten adjusting screw lock nut. Connect the ground cable to generator.

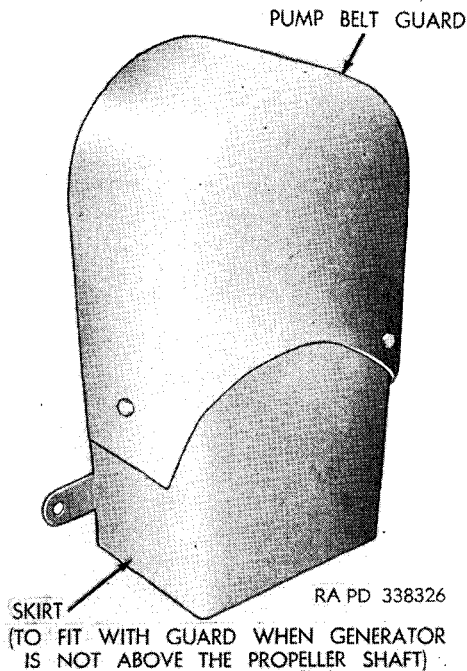

Figure 29. Pump belt guard and skirt.

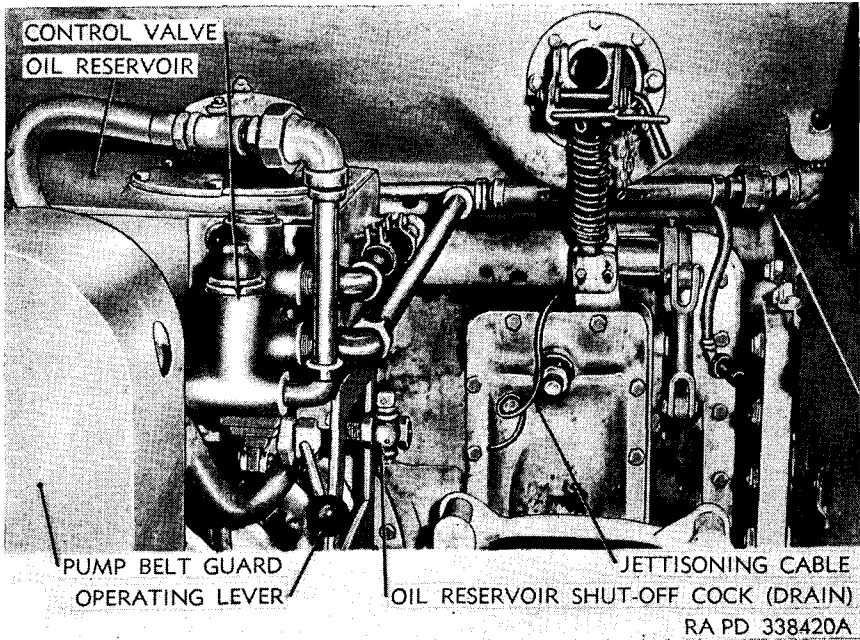

Figure 30. Assistant operator's compartment.

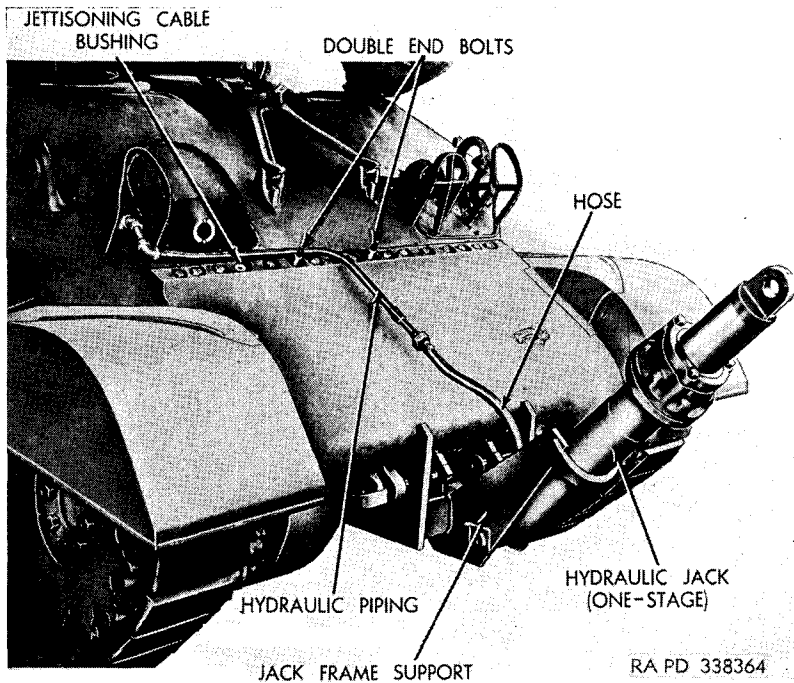

Figure 31. External hydraulic line connected to jack.

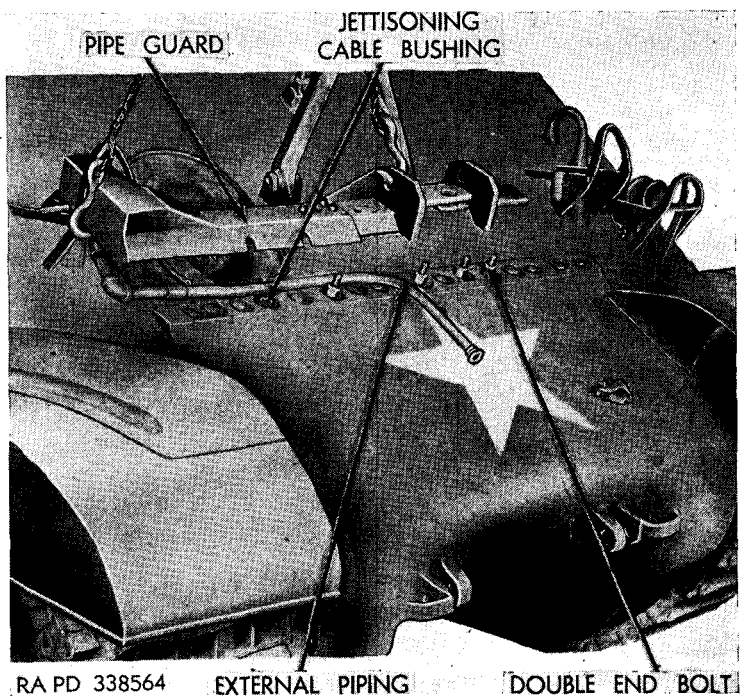

Figure 32. Installing pipe guard.

t. **INSTALL PUMP DRIVE BELT GUARD.** Install pump drive belt guard (fig. 29) and fasten to pump mounting plate (fig. 27) with two screws on the right side of guard. On early model tanks with generator on engine or alongside the propeller shaft, attach skirt to the belt guard.

10. Installation of Hydraulic Group Outside the Tank

a. **INSTALL HYDRAULIC PIPE LINE THROUGH HEADLIGHT SOCKET.** Disconnect and remove right headlight from tank. It will not be reinstalled. Assemble the hydraulic line piping through headlight socket and couple to flexible hose inside the tank (fig. 30) and connect external piping (figs. 31 and 32).

b. **INSTALL PIPE GUARDS.** Replace differential bolts with the double-end bolts (figs. 32 and 33); remove one bolt and nut and insert the jettisoning cable bushing. With an acetylene torch, cut out an opening for jettisoning cable in the pipe guard of bulldozer M1 in line with jettisoning cable bushing. Install pipe guards on the tank and secure with nuts and lock washers.

Note. The upper pipe guard can be adjusted to length required.

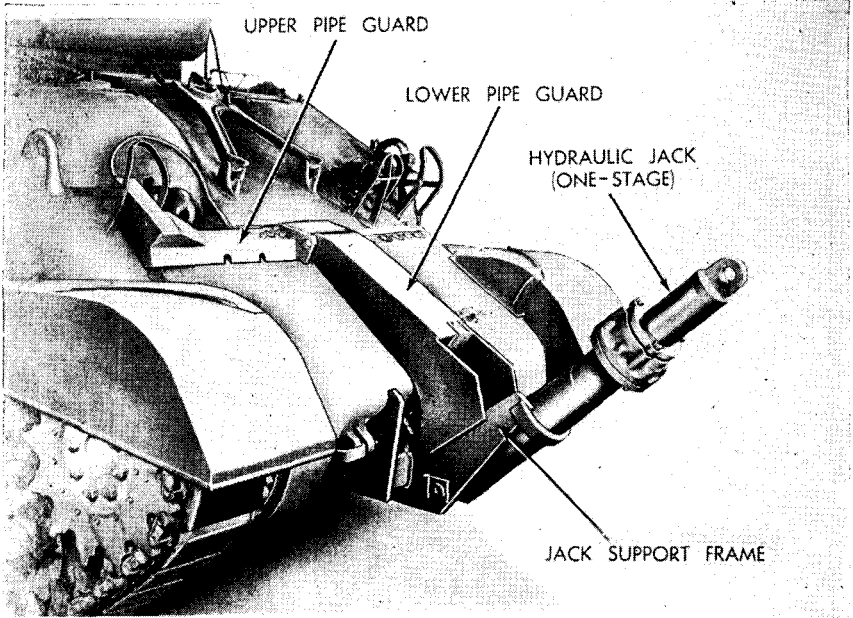

A-ONE-STAGE HYDRAULIC JACK (BULLDOZER M1)
UPPER PIPE GUARD

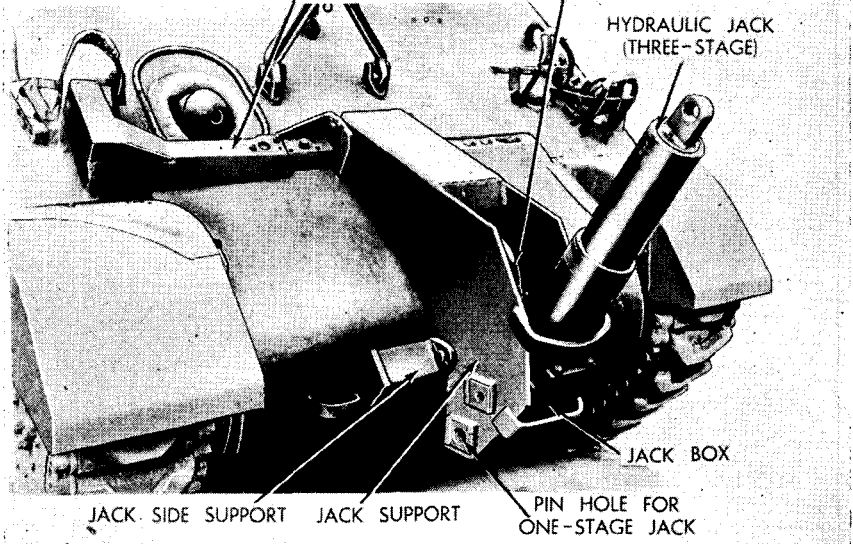

B-THREE-STAGE HYDRAULIC JACK (BULLDOZER M1A1)

RA PD 338360

Figure 33. Hydraulic jack mounted on tank.

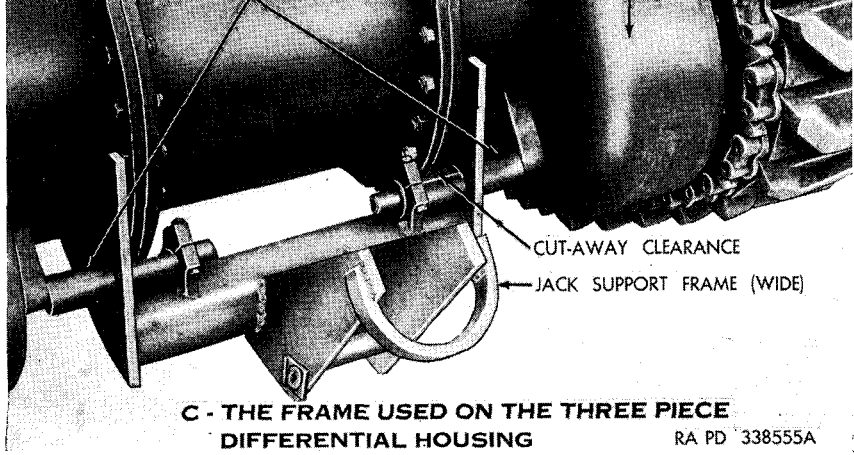
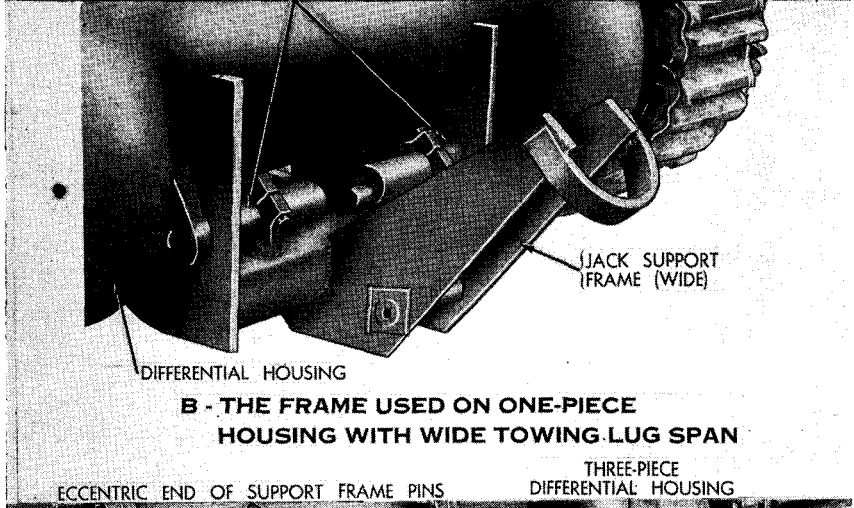
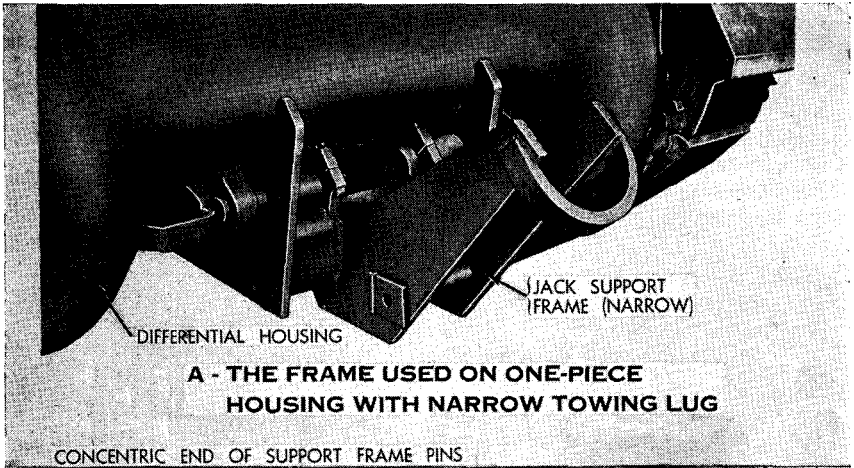
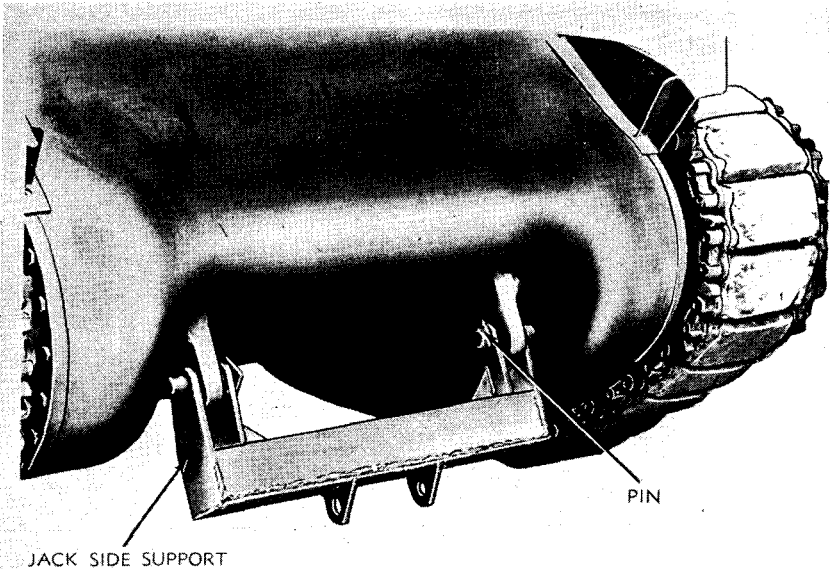
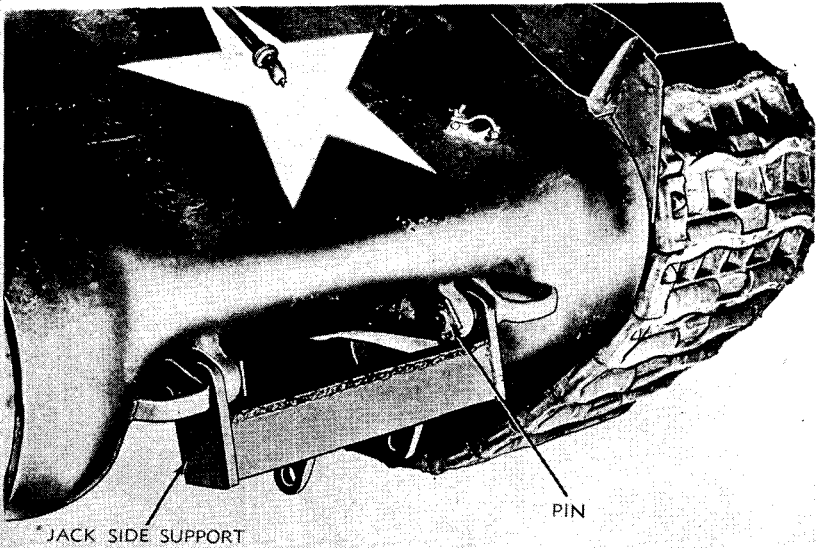

Figure 34. Jack support frames—bulldozer M1.



A—THE SUPPORT USED ON ONE-PIECE DIFFERENTIAL HOUSING WITH WIDE TOWING LUG SPAN



B—THE SUPPORT USED ON ONE-PIECE DIFFERENTIAL HOUSING WITH NARROW TOWING LUG SPAN

RA PD 338582A

Figure 35. Jack side supports—bulldozer M1A1.

On bulldozer M1, install the lower pipe guard in position to upper pipe guard and secure it with two bolts and nuts at the top.

c. **INSTALL JACK SUPPORT FRAME (BULLDOZER M1).** Two jack support frames are provided with each bulldozer set. Refer to figure 34 and select the one required. The other frame will be surplus to any specific installation. Remove the towing hooks from towing lugs. Install the proper jack support frame and firmly secure the pins with clamp bolts.

d. **INSTALL JACK SUPPORT AND JACK SIDE SUPPORT (BULLDOZER M1A1).** Two jack side supports are provided with each bulldozer set; refer to figure 35 and select the one required. The other support will be surplus to any specific installation. Remove towing hooks from towing lugs. Install the proper jack side support to towing lugs, secure with pins, and lock with cotter pin. Install jack support on tank, connecting the pin at the bottom to jack side support and the pin at the top to the pipe guard. Lock each pin with a cotter pin.

e. **INSTALL HYDRAULIC JACK (BULLDOZER M1)** (fig. 36). Install the long hose to the jack. Install the hydraulic jack in jack support frame and insert connecting pin. Lock with a cotter pin. Couple the long hose to the piping.

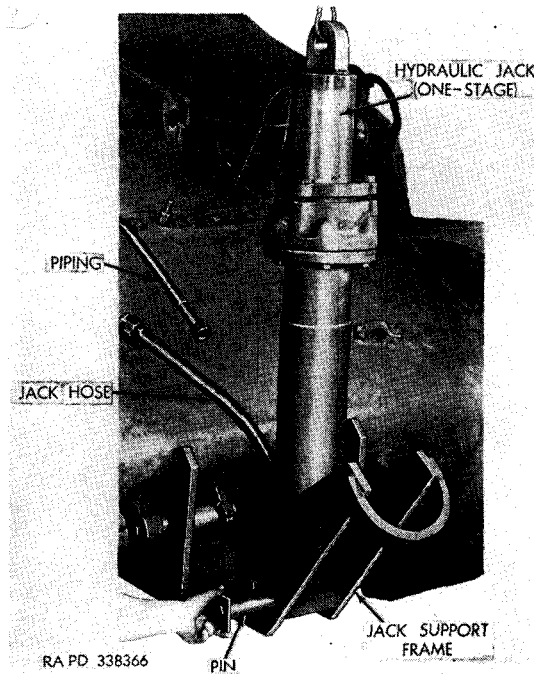

Figure 36. Connecting hydraulic jack to jack support frame—bulldozer M1.

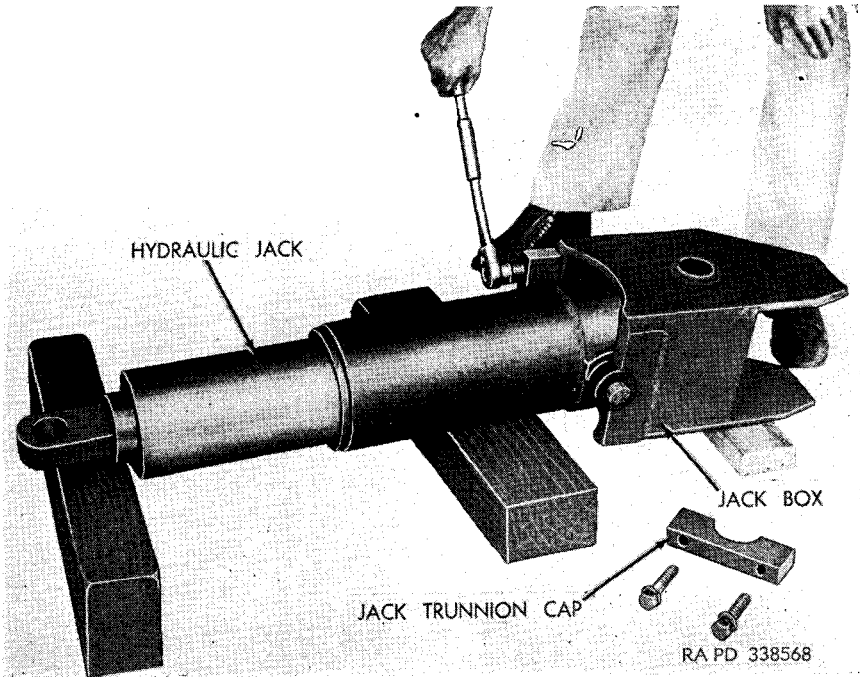

Figure 37. Assembling jack box to jack—bulldozer M1A1.

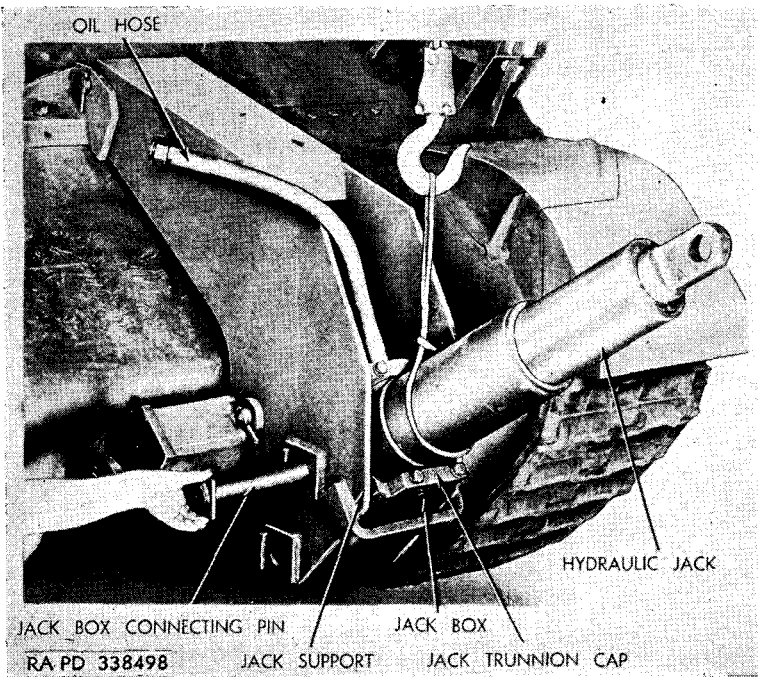

Figure 38. Installing hydraulic jack and jack box to jack support—bulldozer M1A1.

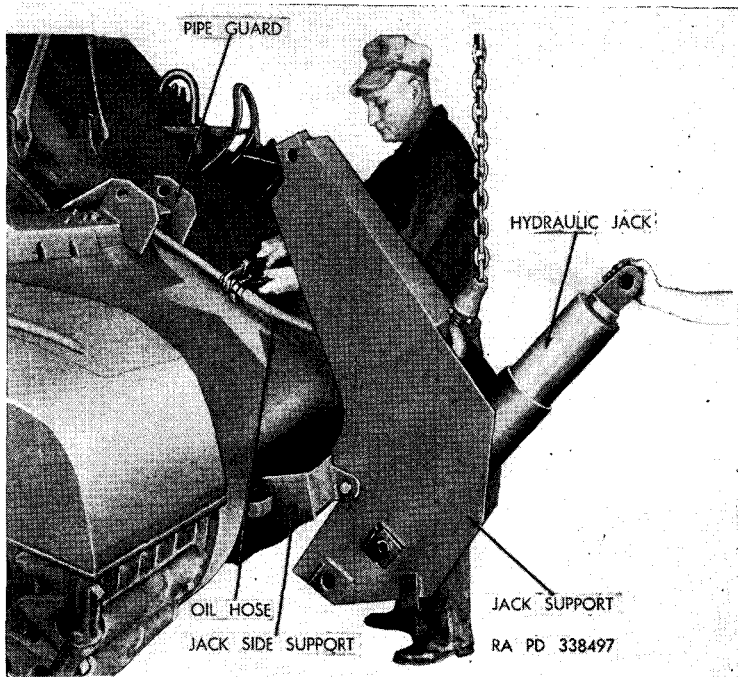

Figure 39. Coupling the hydraulic jack oil hose—bulldozer M1A1.

f. INSTALL HYDRAULIC JACK AND JACK BOX (BULLDOZER M1A1). Attach jack box to hydraulic jack with trunnion caps, each held with two bolts (fig. 37). Install jack and jack box in jack support and insert connecting pin (fig. 38). Lock connecting pin with cotter pin. Support the weight of the jack support with a hoist and temporarily remove pin connecting jack support to pipe guard (fig. 39). Lower the jack support and guide the jack so that it stands vertically; couple the jack oil hose to the external piping. Raise the jack support in position and connect the support to the pipe guard with the connecting pin.

11. Installation of Suspension Mounting Bracket Group

a. INSTALL VERTICAL SUSPENSION MOUNTING BRACKETS. (1) *Standard vertical suspension tank (bulldozer M1)* (figs. 40 and 41.) Remove the first and second suspension bracket caps from each side of tank. These caps are surplus to the bulldozer installation. Install the suspension mounting block on the front suspension bracket on each side of the tank but do not tighten at this time. Fasten the angle support to the front side of the second suspension bracket on each side of the tank. Install the suspension mounting bracket and

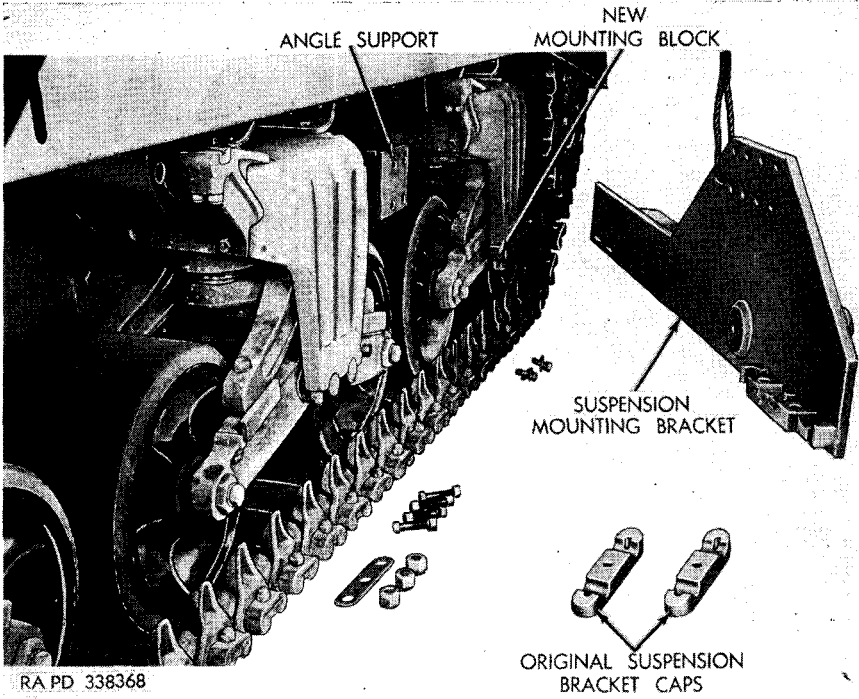

Figure 40. Installing suspension mounting*bracket.

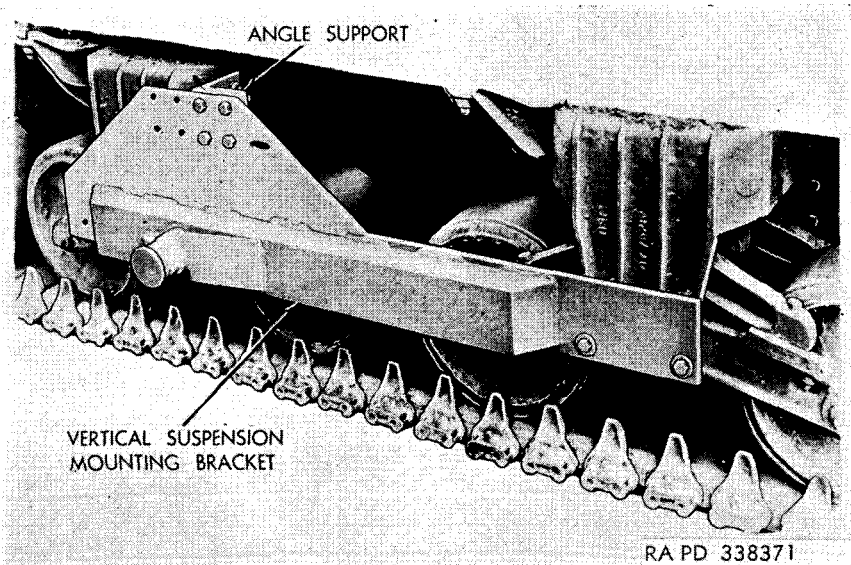

Figure 41. Vertical suspension mounting bracket installed—bulldozer M1.

simultaneously secure it to the second suspension bracket, suspension mounting block, and angle support; tighten the suspension mounting block.

(2) *Standard vertical suspension tank (bulldozer M1A1)*. Install the vertical suspension mounting brackets on the standard vertical suspension tank, as instructed in (1), above, using the vertical suspension brackets and standard vertical suspension adapter pivots (fig. 42).

(3) *Spaced vertical suspension tank (bulldozer M1A1)*. Install the vertical suspension mounting brackets on the spaced vertical suspension tank, as instructed in (1), above, using the vertical suspension brackets and spaced vertical suspension adapter pivots (fig. 42).

b. **INSTALL HORIZONTAL SUSPENSION MOUNTING BRACKETS ON HORIZONTAL SUSPENSION TANK (BULLDOZER M1A1)** (figs. 41 and 43).

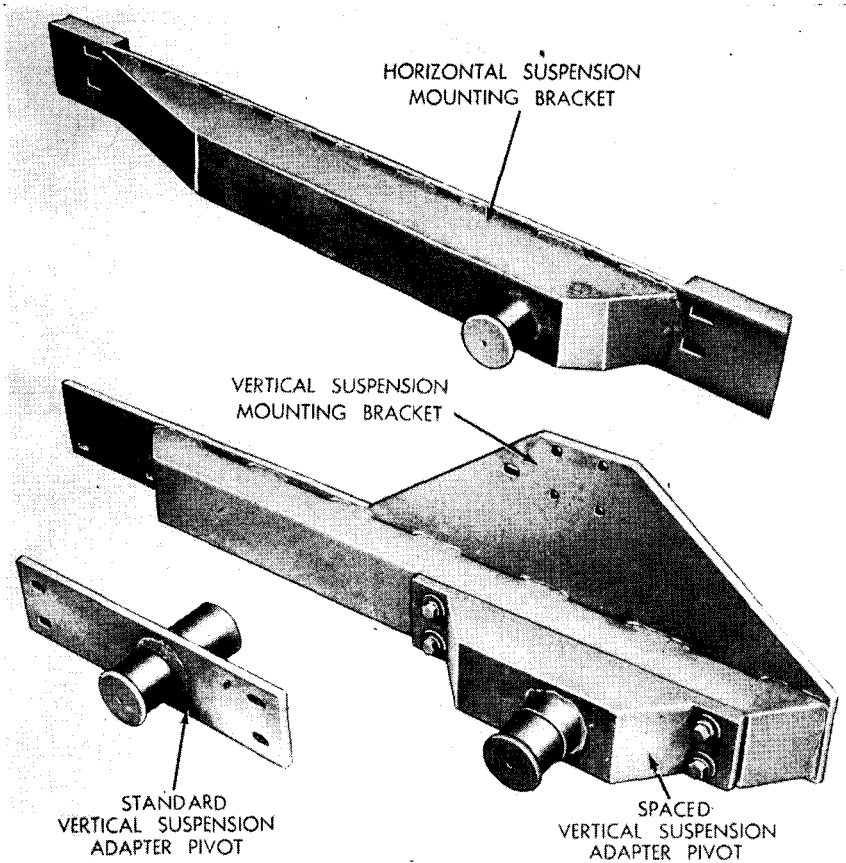

RA PD 338562

Figure 42. Suspension mounting brackets—bulldozer M1A1.

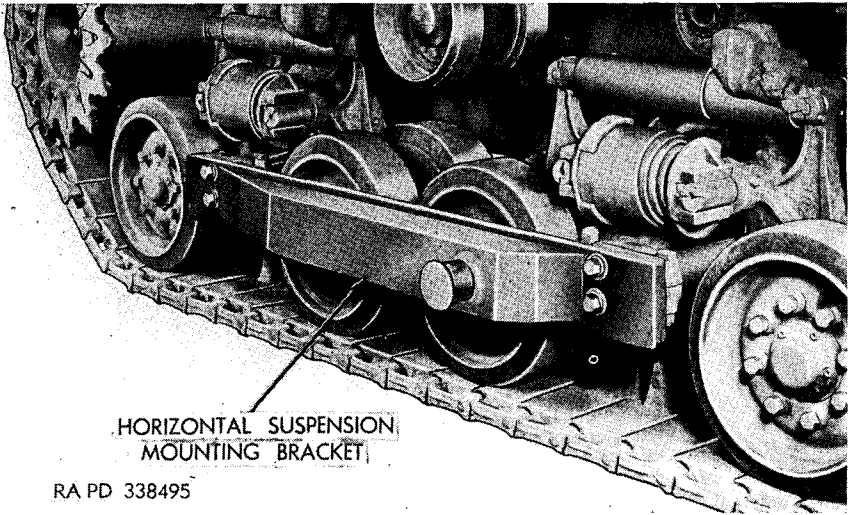

HORIZONTAL SUSPENSION
MOUNTING BRACKET

RA PD 338495

Figure 43. Horizontal suspension mounting bracket installed—bulldozer M1A1.

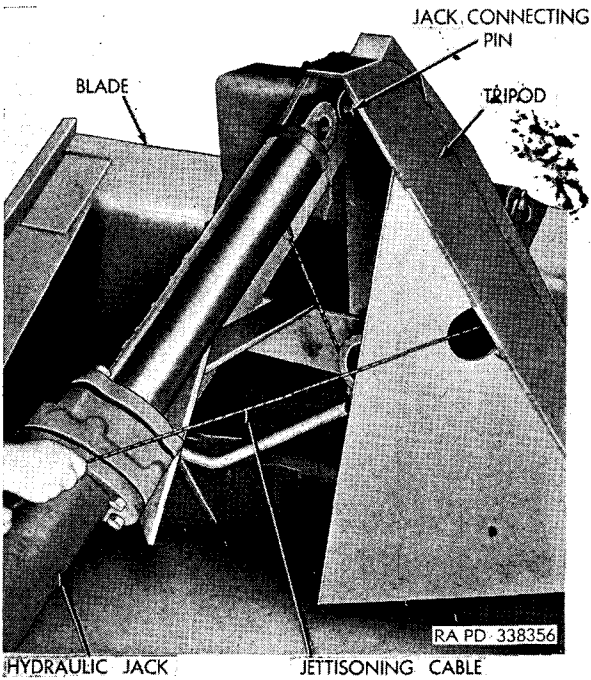

JACK, CONNECTING
PIN

BLADE

TRIPOD

HYDRAULIC JACK

JETTISONING CABLE

RA PD 338356

Figure 44. Connecting hydraulic jack to tripod—bulldozer M1.

Remove the two screws in the first and second suspension arm supports and install the horizontal suspension mounting bracket to the suspension arm supports, using four long bolts, lock washers and spacer washers between bracket and support. Before tightening the bolts, tighten the setscrew on the back of the mounting bracket and lock the setscrew with the lock nut.

12. Installation of Bulldozer Blade Group

Drive the tank slowly forward, carefully keeping the tank centered between the bulldozer sidearms. When the pivots on the tank mounting brackets are approximately 2 feet to the rear of the bulldozer sidearm rear ends, stop the tank. Raise the hydraulic jack (control lever in rear position) until the hole in the end of the jack is at the same height as the connecting pin in the tripod assembly (fig. 44). While the jack is being engaged, it will be necessary for the assistant operator outside of the tank to hold the connecting pin in the tripod assembly in the open position by pulling the jettisoning cable in the tripod. After the connecting pin in the tripod assembly has entered the hole in the hydraulic jack, leave control lever in "hold position" and move tank forward slowly, allowing the sidearm to raise. The assistant operator will guide

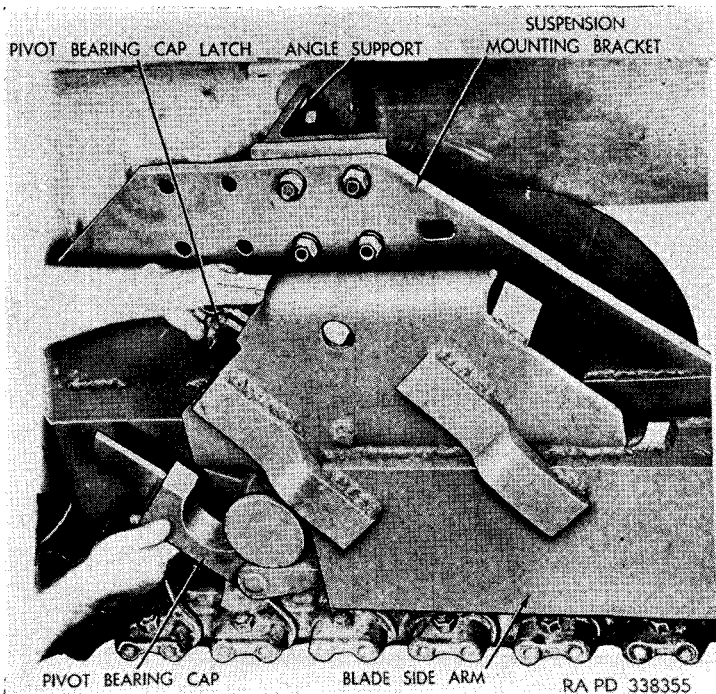

Figure 45. Connecting the blade to suspension mounting bracket pivot.

the sidearm ends in position on mounting bracket pivots and lock the latch on the pivot (fig. 45). After sidearm latches are secure, the end of the jettisoning cable must be threaded through the pipe guard opening and jettisoning cable bushing (fig. 32), and the end of cable must be attached loosely on the inside of the tank to release lever.

13. Installation of Periscope M14 (T18) on Tank

Periscope M14 (T18) kit (wide vision) (figs. 46, 47, and 48) is used to replace the original periscope in driver's hatch door on bulldozer equipped tanks, in order to improve driver's vision (see MWO ORD G-104-W113).

14. Purpose of Service upon Receipt of Equipment

a. When a new or reconditioned vehicle is first received by the using organization, it is necessary for organizational maintenance personnel to determine whether or not the vehicle is in good condition to perform any mission to which it may be assigned when placed in service. For this purpose, inspect all assemblies, sub-assemblies, and accessories to be sure they are properly assembled, secure, clean, and correctly adjusted and/or lubricated.

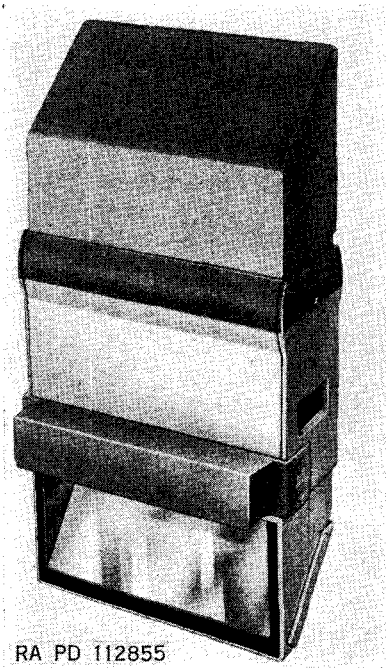

RA PD 112855

Figure 46. Periscope M14 (T18).

b. Parts which have been removed from the tank during installation and which have been replaced by bulldozer parts should be retained in the organization for restoration on the tank when the bulldozer is removed and the tank is reconditioned for use in combat.

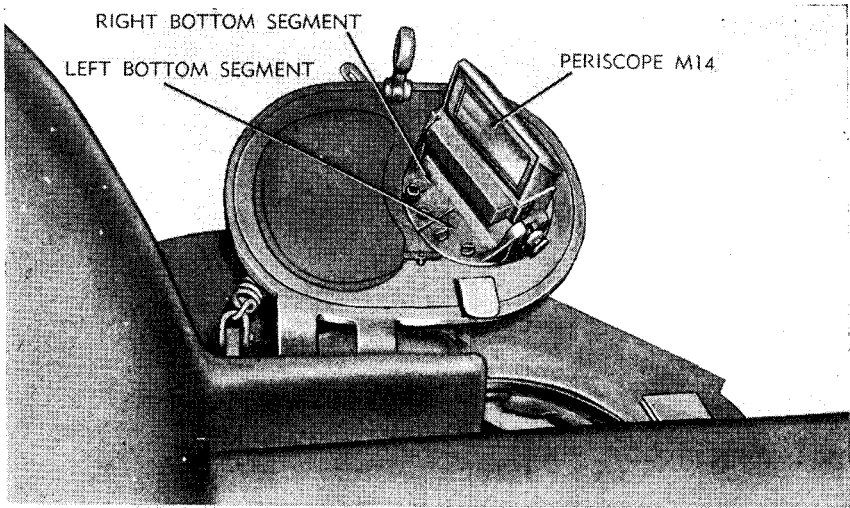

A-INTERIOR VIEW

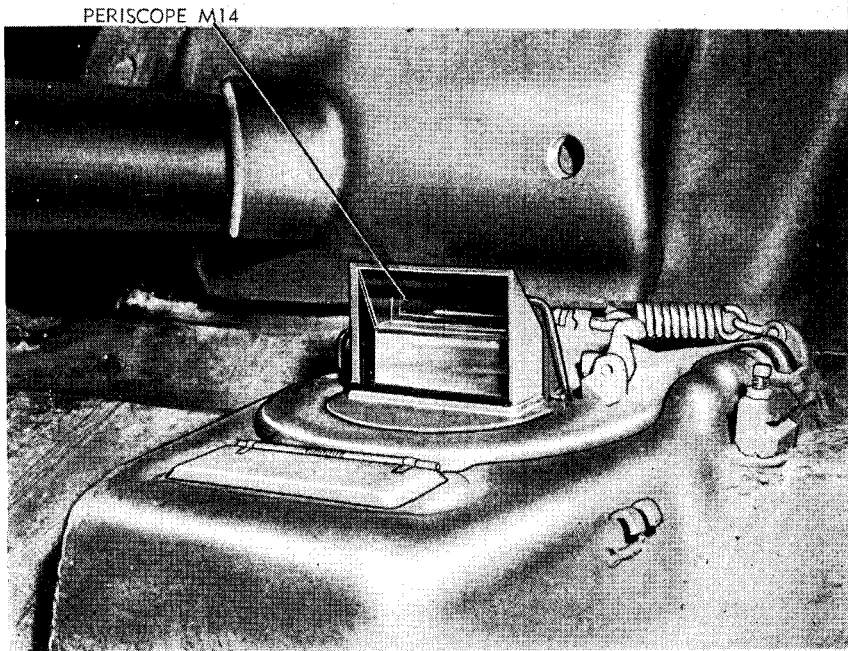

B-EXTERIOR VIEW

RA PD 338493A

Figure 47. Wide vision periscope M14 (T18) installed.

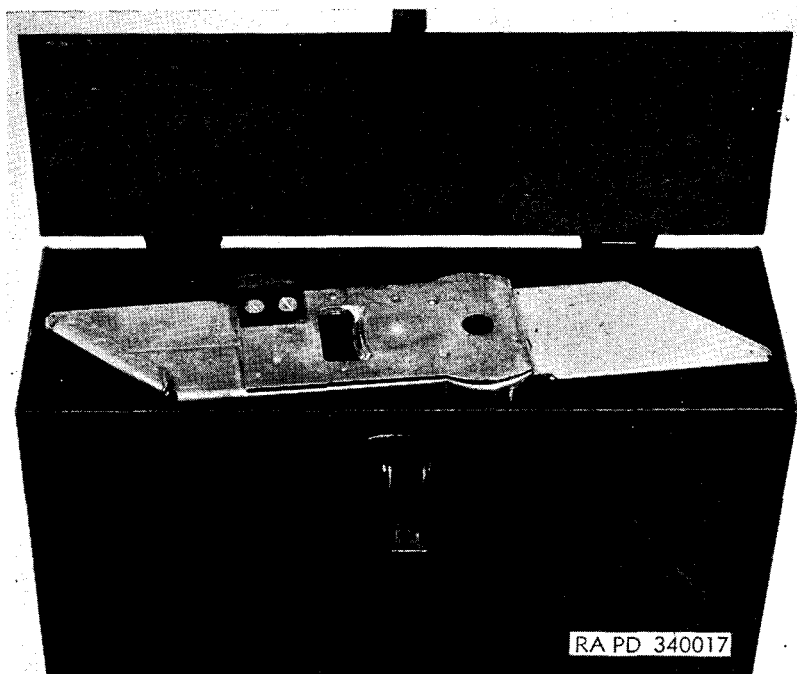

Figure 48. Spare wide vision periscope M14 (T18) stowed in carrying box.

c. Whenever practicable, the using arm personnel (operator, driver, or crew) will assist in the performance of these services.

15. Correction of Deficiencies

Deficiencies disclosed during the course of these services will be treated as follows:

a. Correct any deficiencies within the scope of the maintenance level of the using organization before the vehicle is placed in service.

b. Refer deficiencies beyond the scope of the maintenance level of the using organization to a higher level for correction.

c. Bring deficiencies of a serious nature to the attention of the supplying organization through proper channels.

16. Specific Procedures

a. **BLADE, SIDE BITS, AND CUTTING EDGES.** Examine blade, side bits, and cutting edges to see that all mounting and assembly nuts are present and secure.

b. **SIDE ARMS, MOUNTING BRACKETS, PIVOT BEARINGS, AND LATCHES.** Inspect mounting bracket cap screws to see that they are secure. See that rust and corrosion-prevention material is removed from pivot bearings and latches.

c. **TRIPOD, JETTISONING ASSEMBLY, AND CABLES.** Examine tripod mounting pins, and jettisoning cable drum and pulley nuts to see that they are present and secure. Inspect cables, cable clamps, cable thimbles, cable shackles, and shackle pins to see that they are present and securely attached.

d. **HYDRAULIC JACK AND JACK SUPPORT BRACKET ASSEMBLY.** Be sure that jack support bracket mounting cap screws and mounting pins are present and secure, and that all rust and corrosion-prevention material is removed from hydraulic jack pistons.

e. **HYDRAULIC PIPE LINES, HOSE, AND GUARD.** Examine hydraulic pipe lines and hose to see that they are securely supported and connected, and that the hydraulic pipe line guard cap screws are secure.

f. **OIL RESERVOIR, PIPE LINES, AND HOSE.** Inspect reservoir mounting cap screws and nuts to see that they are secure. Be sure reservoir screen is clean and that the reservoir breather is not clogged. Check oil supply in reservoir to see that it is at the proper level.

g. **PUMP, PUMP MOUNTINGS, DRIVE BELTS, AND BELT GUARD.** Check pump mounting and belt guard cap screws and nuts to see that they are secure. Be sure that pump drive belts are adjusted properly (par. 9*g*) and that belt adjusting screw is locked.

h. **CONTROL VALVE AND CONTROL LEVERS.** Be sure that rust and corrosion-prevention material is removed from control valve and linkage and that all hose connections are secure.

i. **JETTISONING CONTROL AND MOUNTINGS.** Examine jettisoning control lever mountings to see that they are secure. Be sure that all tape and rust and corrosion-prevention material is removed from jettisoning cable passage through jettisoning cable bushing.

j. **PUBLICATIONS.** See that vehicle and bulldozer operator's manuals, lubrication order, and WD AGO Form 478 pertaining to the bulldozer are legible and properly stowed.

Note. U.S.A. registration number and vehicle nomenclature must be filled in on Form 478 for new vehicles.

k. **REPORTS.** Report general condition of the bulldozer to designated individual in authority.

Section V. CONTROLS AND OPERATION

17. Controls

a. **CONTROL LEVERS** (fig. 6). The dual control levers are mounted on the rear of the bulldozer oil reservoir (fig. 23) and connected to the control valve by linkage. One control lever is located on the right of the driver and the other control lever is on the left of the assistant driver. Both control levers operate the bulldozer blade.

b. **RELEASE JETTISONING CABLE** (figs. 4 and 44). The jettisoning cable is a steel-braided cable threaded through the jettisoning cable

bushing to inside of tank within reach of the assistant driver. The cable is attached to the jack connecting pin which holds the hydraulic jack to the tripod and to the two latches which hold the bulldozer blade on the side pivots. The cable is so arranged inside the tripod that by pulling the jettisoning cable inside the tank it will at once release the bulldozer blade.

18. Operation

a. BEFORE-OPERATION SERVICE. Perform the services in paragraph 32 before using the bulldozer.

b. OPERATION OF BULLDOZER. With the bulldozer attached, operate the tank in low gear and in the same manner as the tank is operated alone; however, the turning radius required will be greatly increased (refer to technical manual on respective tank). The driver should raise and lower the blade of the bulldozer several times to become familiar with the operation of the controls before moving earth or obstacles. Move the tank forward slowly in low gear before lowering the blade (control lever in forward position) to digging position. Lower the blade gradually until the desired depth has been reached. With the tank moving forward at a steady speed, raise or lower the blade to compensate for uneven ground.

c. JETTISONING BULLDOZER BLADE FROM THE TANK. Jettisoning the blade is accomplished more easily when the blade is entered in the ground. However, the jettisoning can be accomplished with the tank headed either upgrade or down grade or in any position except while actually backing the tank. To jettison the blade and leave it in position where it may be quickly attached again, enter the blade in the ground on a fairly level spot. Drive the tank forward slowly and hold the control lever forward in the lowering position. As the blade enters the ground, the assistant operator will pull the jettisoning cable. When the pin connecting the jack to the tripod is fully released, the latches at the end of the sidearms will also be released, disengaging the sidearms from the pivots. The assistant driver will hold the jettisoning cable while the driver backs the tank slowly. As soon as the upper end of the jack clears the tripod, the assistant driver will observe the jettisoning cable to be sure it does not become tangled with any of the inside equipment or personnel as it leaves the tank through the bushing. After the tank has been backed a sufficient distance to clear the sidearms, the tank may be maneuvered at will.

Caution: Never run the piston of the hydraulic jack out of the cylinder while the blade is not attached to the tank, as it will take considerable weight to force the piston down in position to remount the blade.

d. MOUNTING THE BULLDOZER BLADE ON THE TANK. Mount the bulldozer blade on the tank (par. 12).

19. Operating Precautions

a. When making a level cut, do not lower the blade to the point where it will stall the engine. Take only the depth of cut that can be handled without slowing the speed of the engine too much.

b. Watch the up-and-down motion of the front of the tank and compensate for same. When the front of the tank starts to "nose up," lower the blade, and when the front of the tank starts to "nose down," raise the blade, but only far enough to compensate for the motion.

c. When cutting very hard material and the engine becomes overloaded, raise the blade slightly.

d. When the blade is full of material, lift blade slightly before trying to turn.

e. When on steep inclines, keep tank in first or second gear and the master clutch engaged. Use compression of tank engine to hold speed down.

f. Never engage clutch only part way in. Return steering levers to full released position immediately after using.

Section VI. OPERATION UNDER UNUSUAL CONDITIONS

20. Sources of Information

For operation of equipment under all unusual conditions, refer to the pertinent technical manual covering tank upon which bulldozer is mounted.

21. Cold Weather Conditions

a. GENERAL. Since sub-zero temperatures affect both metals and lubricants, operation of equipment at sub-zero temperatures presents problems that demand special precaution. Extremely careful servicing from both operating and maintenance personnel is required if poor performance and total functional failure are to be avoided.

b. LUBRICATION. Section X and Lubrication Order LO 9-719 prescribe lubrication maintenance for this bulldozer. Lubrication of the bulldozer in cold weather requires no special attention other than rigid adherence to the instructions in section X.

Section VII. DEMOLITION TO PREVENT ENEMY USE

22. General

a. Destruction of the bulldozer when subject to capture or abandonment in the combat zone is undertaken by the using arm only

when, in the judgment of the military commander concerned, such action is necessary.

b. The instructions which follow are for information only. The conditions under which destruction will be effected are command decisions in each case, according to the tactical situation.

c. If destruction is resorted to, the vehicle must be so badly damaged that it cannot be restored to a usable condition in the combat zone either by repair or cannibalization. Adequate destruction requires that all parts essential to the operation of the vehicle be destroyed or damaged beyond repair. It is equally important that the same essential parts must be destroyed on all like vehicles so that the enemy cannot construct one complete operating unit from several partially damaged ones.

23. Detailed Instructions

Note. The following instructions contain a method of demolition to be used only when the bulldozer has been jettisoned from the vehicle.

Attach a 2-pound TNT charge to the extreme end of each sidearm pivot bearing (fig. 45) and a 2-pound TNT charge in the tripod assembly directly beneath the jack connecting pin (fig. 44). Insert tetryl nonelectric caps with at least 5 feet of safety fuze in each charge. Ignite fuzes and take cover.

Caution: If charges are prepared beforehand and carried in the vehicle, keep the caps and fuzes separated from the charges until they are to be used.

See FM 5-25 for details of planning and execution of demolition procedures.

PART THREE

MAINTENANCE INSTRUCTIONS

Section VIII. GENERAL

24. Scope

Part three contains information for the guidance of the personnel of using organizations responsible for the organizational maintenance of this equipment. It contains information needed for the performance of the scheduled lubrication and preventive maintenance services, as well as the description and maintenance of the major systems and units and their functions in relation to other components of the equipment.

Section IX. ORGANIZATIONAL SPARE PARTS, TOOLS, AND EQUIPMENT

25. Organizational Spare Parts and Equipment

a. SPARE PARTS. A set of organizational spare parts is supplied to the using arm for field replacement of those parts most likely to become worn, broken, or otherwise unserviceable.

b. EQUIPMENT. A set of organizational equipment is supplied to the using arm for maintaining and using the matériel.

c. LIST OF SPARE PARTS AND EQUIPMENT. Spare parts and equipment supplied for bulldozers M1 and M1A1 are listed in Army Supply Catalog pamphlet ORD 7 SNL G-228, which is the authority for requisitioning replacements.

26. Special Tools

No special tools are required for organizational maintenance of bulldozer. Tools issued with the tank are adequate for bulldozer maintenance.

Section X. LUBRICATION

27. Lubrication Order

a. Reproduction of Lubrication Order 9-719 (fig. 49) prescribes organizational lubrication maintenance. Lubrication to be performed by ordnance maintenance personnel is covered in paragraph 28.

b. A lubrication order is issued with each item of matériel and is to be carried with it at all times. In the event the matériel is received

LUBRICATION ORDER LO 9-719

(Supersedes WDLO 9-719, 20 JUNE 1945)

BULLDOZER, TANK, M1

References: TM 9-719, ORD 7-5NL G-228

Intervals are based on normal operation. Reduce to compensate for abnormal operation and severe conditions. During inactive periods, intervals may be extended commensurate with adequate preservation.

Relubricate after washing or fording.
Clean fittings before lubricating.
Clean parts with SOLVENT, dry cleaning. Dry before lubricating.

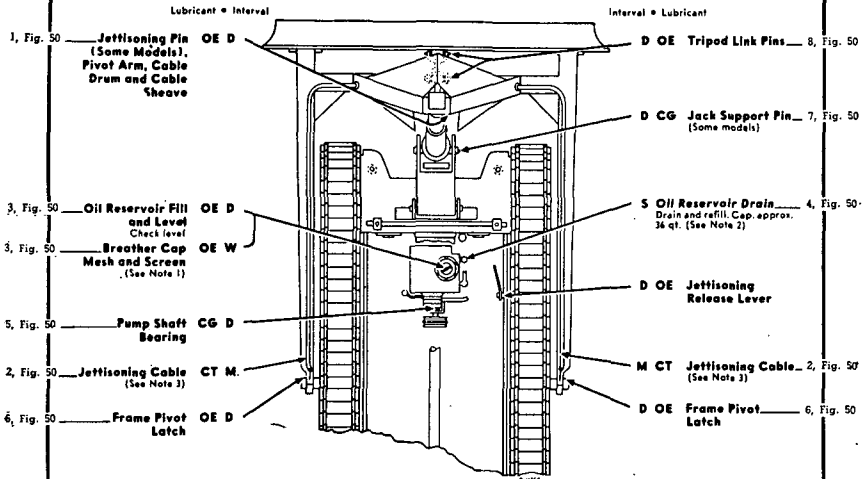

KEY and NOTES

LUBRICANTS	EXPECTED TEMPERATURES			TEMPERATURE RANGE OF LUBRICANT	LUBRICANTS	INTERVALS
OE—OIL, engine	above +32°F.	+32°F. to 0°F.	0°F. to -40°F.		OH—OIL, hydraulic or Navy Spec. 51F21 (ORD)	D—Daily
Hydraulic System	OE 30 or N.S. 9250	OE 10 or N.S. 9110	OH	PL—OIL, lubricating, preservative	W—Weekly	
Other Points	OE 30 or N.S. 9250	OE 10 or N.S. 9110	PL—Special or Navy Spec. OS 174	CT—COMPOUND, rust preventive, thin film	M—Monthly	
CG—GREASE, general purpose	CG 1 or Navy Spec. 14L9	CG 0	CG 0		S—Semi-annually	

1. OIL RESERVOIR BREATHER—Weekly, disassemble, wash elements, dry and reoil. Drain excess oil and reassemble. Use OE or used crankcase oil above 0°F. or OE 10 below 0°F.
2. OIL RESERVOIR—Drain only after operation. Refill to FULL mark. Operate jack up and down a few times and recheck level.
3. JETTISONING CABLES—Monthly, clean all jettisoning cables and coat with COMPOUND, rust preventive, thin film.
4. OIL CAN POINTS—Daily, lubricate all linkage, hinges and latches with OE.

Copy of this Lubrication Order will remain with the equipment at all times; instructions contained herein are mandatory and supersede all conflicting lubrication instructions dated prior to the date of this Lubrication Order.

BY ORDER OF THE SECRETARY OF THE ARMY:

OFFICIAL: EDWARD F. WITSELL,
Major General,
The Adjutant General.

OMAR N. BRADLEY,
Chief of Staff.

Requisition additional Lubrication Orders in conformance with instructions in TM 38-405.

RA PD 113863

Figure 49. Lubrication order.

without a copy, the using arm shall immediately requisition a replacement in conformance with lists in FM 21-6 and instructions in TM 38-405.

c. Instructions on the lubrication order are binding on all levels of maintenance and there will be no deviations.

d. Service intervals specified on the lubrication order represent minimum maintenance to be performed by the using organization. Reduce to compensate for abnormal operation and extreme conditions such as excessively high or low temperatures, prolonged periods of high-speed operation, continued operation in sand or dust, immersion in water, or exposure to moisture, any one of which may

quickly destroy the protective qualities of the lubricants. Intervals may be extended during inactive periods.

e. Lubricants are prescribed in the "KEY" in accordance with four temperature ranges, above $+32^{\circ}\text{F}$., from $+32^{\circ}\text{F}$., to 0°F ., 0°F . to -40°F ., and below -40°F . The time to change grades of lu-

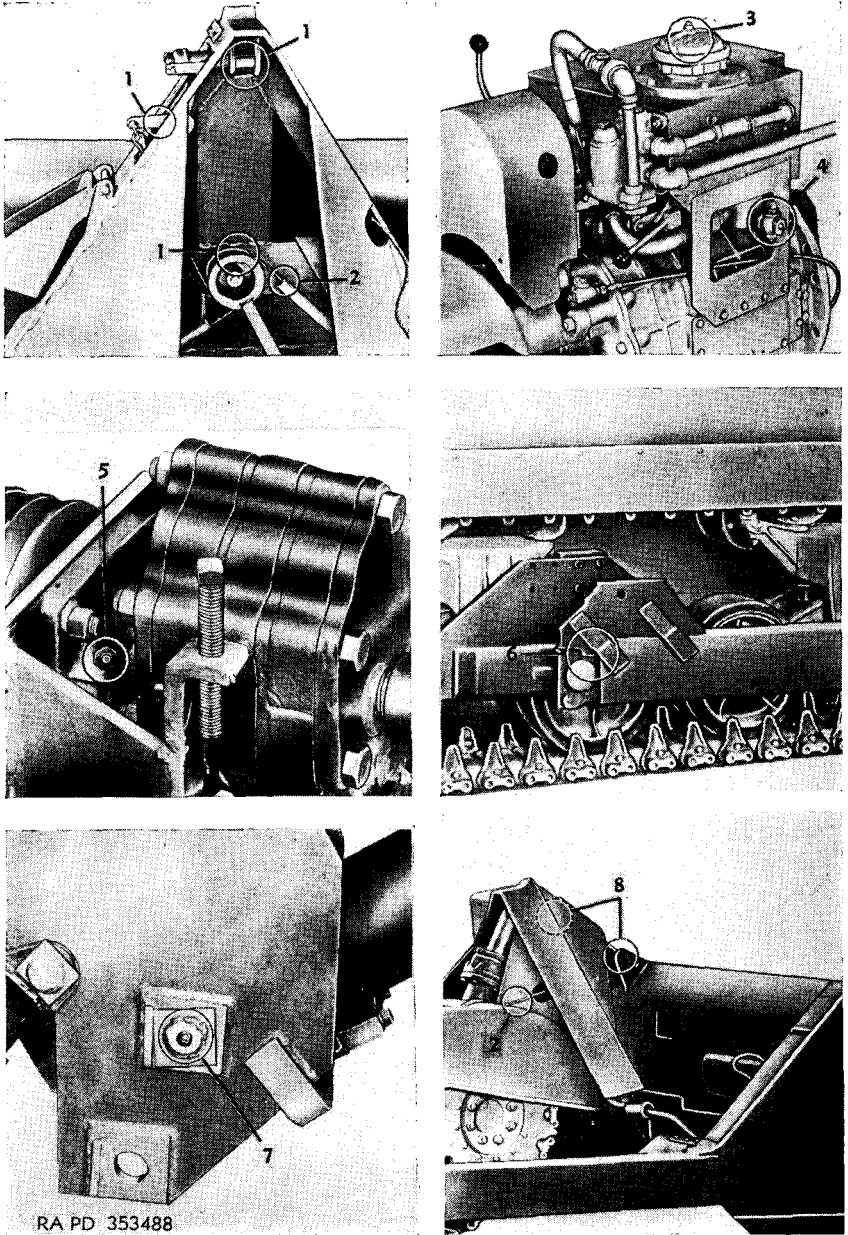

Figure 50. Lubrication localized views.

bricants is determined by maintaining a close check on operation of the matériel during the approach to change-over periods, especially during initial action. Sluggish starting is an indication of thickening of lubricants and is the signal to change to grades prescribed for the next lower temperature range. Ordinarily, it will be necessary to change grades of lubricants only when air temperatures are consistently in the next higher or lower range.

28. Detailed Lubrication Instructions

a. LUBRICATION EQUIPMENT. Each piece of matériel is supplied with lubrication equipment adequate to maintain the matériel. This equipment is cleaned both before and after use. Lubrication guns are to be operated carefully, and in such a manner as to insure a proper distribution of the lubricant.

b. POINTS OF APPLICATION. (1) Lubricating fittings and oilholes are readily located by references to the lubrication order (fig. 49) and to figure 50. Wipe these devices and the surrounding surfaces clean before lubricant is applied.

(2) Where relief valves are provided, apply new lubricant until the old lubricant is forced from the vent.

29. Reports and Records

a. Report unsatisfactory performance of matériel to the ordnance officer responsible for maintenance in accordance with TM 38-650.

b. A record of lubrication may be maintained on WD AGO Form 460.

Section XI. PREVENTIVE MAINTENANCE SERVICES

30. General Information

a. RESPONSIBILITY AND INTERVAL. Preventive maintenance services as prescribed by AR 850-15 are a function of using organization levels of maintenance, and their performance is the responsibility of the commanders of such organizations. These services consist generally of before-operation, during-operation, at-halt, after-operation, and weekly services performed by the operator, driver, or crew, and the scheduled services to be performed at designated intervals by organizational maintenance personnel.

b. DEFINITION OF TERMS. The general inspection of each item applies also to any supporting member or connection and is generally a check to see whether or not the item is in good condition, correctly assembled, secure, or excessively worn.

(1) The inspection for "good condition" is usually an external visual inspection to determine whether the unit is damaged beyond safe or serviceable limits. The term "good condition" is explained further by the following: not bent or twisted, not chafed or burned,

not broken or cracked, not bare or frayed, not dented or collapsed, not torn or cut, or not deteriorated.

(2) The inspection of a unit to see that it is “correctly assembled” is usually an external visual inspection to see whether or not it is in its normal assembled position in the vehicle.

(3) The inspection of a unit to determine if it is “secure” is usually an external visual examination—a wrench, hand-feel, or a pry-bar check for looseness. Such an inspection must include any brackets, lock washers, lock nuts, locking wires, or cotter pins used in assembly.

(4) “Excessively worn” will be understood to mean worn beyond serviceable limits or to a point likely to result in failure if the unit is not replaced before the next scheduled inspection.

31. Organizational Maintenance (Operator, Driver, or Crew)

a. PURPOSE. To insure mechanical efficiency, it is necessary that this bulldozer be systematically inspected at intervals during each day that it is operated so that any defects may be discovered and corrected before they result in serious damage or failure. The services set forth in this section are those to be performed by the driver and crew before operation, during operation, at halt, and after operation.

b. PROCEDURES. The general inspection of each item also applies to any supporting member or connection, and generally includes a check to determine if the item is in good condition, correctly assembled, secure, or excessively worn. For information pertaining to the vehicle on which this bulldozer is mounted, refer to TM 9-731A, TM 9-731AA, TM 9-731B or TM 9-759.

32. Before-Operation Service

a. Purpose. This inspection schedule is designed primarily as a check to determine if the bulldozer has been damaged as a result of tampering, sabotage, shell fire, or collision since the after-operation service was performed. This operation will not be entirely omitted even in extreme tactical situations.

b. PROCEDURES. The before-operation service consists of inspecting the following items according to the procedure described and of correcting or reporting to the designated individual in authority any deficiencies found.

(1) *Tampering and damage.* Inspect the entire unit in general, its mounting brackets, hydraulic jack, controls, pump, reservoir, and lines, for any damage that may make it unfit to perform any mission to which it is assigned.

(2) *Blade, side bits, and cutting edges.* Inspect the blade, side bits, and cutting edges to see that they are in good condition and that all assembly nuts are secure.

(3) *Sidearms, track mounting brackets, and latches.* Examine sidearms for broken welds. See that brackets are mounted securely and that latches operate properly.

(4) *Tripod, jettisoning assembly, and cables.* Inspect tripod, jettisoning assembly, and cables to see that they are in good condition, correctly assembled, and securely mounted.

(5) *Hydraulic jack and jack support brackets.* Examine these items for damage and be sure jack support brackets are securely mounted and attached.

(6) *Hydraulic lines, hose, and guards.* Inspect hydraulic pipe lines and hose to see that they are in good condition, not leaking, securely attached, and supported. Be sure guards are secure and that hydraulic hose does not chafe against support bracket.

(7) *Oil reservoir and lines.* Examine reservoir and lines to see that they are securely mounted, connected, and not leaking. Be sure that oil in the reservoir is at the proper level, that screen in filler neck is clean, and that breather vent is not clogged.

(8) *Pump and mountings.* Inspect pump to see that it is not leaking and that all mountings are secure.

(9) *Control valve and lever, drive belts, and guard.* Examine the control levers to see that they operate freely. See that the belts are properly adjusted (par. 9q) and that the belt guard is securely attached. Pump drive belts should have a 1-inch deflection under normal finger pressure halfway between pulleys.

(10) *Jettisoning control lever and mounting.* Inspect jettisoning control lever to see that it is mounted securely and that it operates properly. Be sure jettisoning cable is securely attached to control lever.

33. During-Operation Service

a. OBSERVATIONS. While bulldozer is in motion, be on the alert for any unsatisfactory operating characteristics such as distortion of component parts or noise that would indicate improper action of the hydraulic system.

b. PROCEDURES. During-operation service consists of observing items listed below according to the procedures, and investigating any indications of serious trouble. Notice minor deficiencies to be corrected or reported at the earliest opportunity, usually at the next scheduled halt.

(1) *Tripod and jettisoning assembly.* Be on the alert for any indications of looseness in visible tripod mounting pins or connections.

(2) *Hydraulic jack and jack supports.* While blade is being raised or lowered, pay particular attention to all visible mountings and connections of the hydraulic jack for any indication of looseness in jack support mounting bolts or pins.

(3) *Hydraulic lines and hose.* During operation, as the blade is raised or lowered, observe the inside lines and hose for leaking or damage.

(4) *Pump, reservoir, and control valve mountings.* Observe pump, reservoir, and control valve mountings for indications of looseness.

(5) *Control valve, control levers, and drive belts.* See that blade responds quickly to movement of control levers without looseness or binding. Observe drive belts to see if they are slipping.

(6) *Jettisoning control.* When jettisoning the blade, see that jettisoning cable end releases from lever easily. As jettisoning cable passes through jettisoning cable bushing, be sure that the cable does not become entangled with equipment or personnel.

34. At-Halt Service

a. IMPORTANCE. At-halt service will be regarded as minimum maintenance procedure and must be performed under all tactical conditions.

b. PROCEDURES. Perform the following procedures, and correct any deficiencies noted during operation or report them to designated individual in authority.

(1) *Blade, side bits, and cutting edges.* Raise blade and inspect blade, bits, and cutting edges for damage, and side bits and cutting edges for sharpness.

Caution: Keep clear of blade, side bits, and cutting edges while performing this operation in case blade may be lowered.

(2) *Sidearms, track mounting brackets, pivot bearings, and latches.* Examine these items to see that they are securely mounted and not damaged and that pivot bearings are securely latched.

(3) *Tripod, jettisoning assembly, and cables.* Inspect tripod welds and mounting pins, jettisoning assembly, and accessible parts of cable to see that they are not damaged and that they are securely mounted and connected.

(4) *Hydraulic jack and jack supports.* Examine these items to see that they are in good condition and securely mounted.

(5) *Hydraulic lines, hose, and guards.* Inspect accessible hydraulic pipe lines, guards, and, particularly, pressure hose to hydraulic jack, to see that they are not damaged and that they are securely mounted and connected.

(6) *Reservoir and lines.* Examine these items to see that they are securely mounted and not leaking and that pipe lines and hose are securely connected.

(7) *Pump and mountings.* Inspect pump, pump mountings, and connections to see that pump and connections are not leaking and mountings are secure.

(8) *Control valve and lever, drive belts, and belt guard.* Examine drive belt for correct tension and belt guard for secure mounting.

(9) *Jettisoning control and mounting.* Inspect jettisoning control lever to see that jettisoning cable is securely attached.

35. After-Operation and Weekly Services

a. PURPOSE. After-operation service is particularly important because at this time the operator, driver, or crew inspects the bulldozer to detect any deficiencies that may have developed and to correct those that they are permitted to handle. The result of this inspection should be reported promptly to the designated individual in authority.

b. PROCEDURES. When performing the after-operation service, the operator, driver, or crew must remember and consider any irregularities noticed during the day in the before-operation, during-operation, and at-halt services. The after-operation service consists of inspecting and servicing the following items (those items marked by an asterisk (*) require additional weekly services):

(1) *Blade, side bits, and cutting edges.* Inspect these items to see that there are no broken assembly welds in the blade, that the side bits and the end and center cutting edges are not damaged, and that the attaching bolts and nuts are tight and secure.

(2) *Sidearms, track mounting brackets, pivot bearings, and latches.* Examine sidearms and mounting brackets for broken assembly welds and see that bracket mounting cap screws are secure. Be sure pivot bearings are not damaged and that the latches operate properly.

(3) *Tripod, jettisoning assembly, and cables.* Inspect tripod for broken assembly welds and secure mounting pins. See that jettisoning assembly is not damaged and operates properly. Be sure that cables are not worn or frayed and that they are securely connected.

(4) *Hydraulic jack and jack support.* Examine hydraulic jack support to see that the assembly welds are not broken and that all mounting bolts and pins are secure. Be sure hydraulic jack is not leaking and that the trunnion cap screws are secure.

(5) *Hydraulic pipe lines, hose, and guard.* Inspect hydraulic pipe lines and hose to see that they are in good condition, securely connected, and not leaking. Be sure that pipe guard is securely mounted and that the pressure line to jack hose is not chafing.

(6) *Reservoir, mountings, lines, and hose.* Be sure that the oil in the reservoir is at proper level and reservoir mountings are secure. Examine pipe lines and hose to see that they are securely mounted and connected and that they are not leaking. Examine screen in reservoir to see that it is clean and that breather vents in filler cap are not clogged.

(7) *Hydraulic pump and mountings.* Examine pump and pump lines to see that they are secure and not leaking and that mounting nuts and cap screws are secure.

(8) *Control valve and lever, drive belts, and belt guard.* Inspect these items to see that they are in good condition and that control lever operates control valve without binding or looseness. Be sure that drive belts have a 1-inch deflection halfway between pulleys and that belt guard is securely mounted.

(9) *Jettisoning control and mounting.* Be sure that jettisoning release lever operates properly and that jettisoning cable is securely attached to lever.

(10) **Tightening.* (a) *After operation.* Tighten all attaching and mounting nuts and cap screws where inspection has indicated the necessity.

(b) *Weekly.* Tighten all jack support nuts and cap screws and track support bracket mounting nuts and cap screws.

(11) **Cleaning.* (a) *After operation.* Clean entire bulldozer. Be sure to remove all stones, shells, and roots from blade, bits, and cutting edges.

(b) *Weekly.* Wash all sand, mud, or dirt from bulldozer when possible.

(12) **Lubrication.* (a) *After operation.* Lubricate all points of the bulldozer listed on the lubrication order as requiring daily lubrication. Be sure to coat moldboard with used engine oil to prevent rust.

(b) *Weekly.* Lubricate all points listed on the lubrication order as requiring lubrication.

36. Organizational Maintenance (Battery Mechanic)

a. **FREQUENCY.** The frequency of the preventive maintenance services outlined herein is considered a minimum requirement for normal operation of bulldozers. Under unusually extreme operating conditions, it may be necessary to perform certain maintenance services more frequently.

b. **USING ARM PERSONNEL PARTICIPATION.** The crew should accompany their bulldozer and assist the mechanics while periodic organizational maintenance services are performed. Ordinarily, the operator should present the unit for a scheduled preventive maintenance service in a reasonably clean condition; that is, it should be dry and not caked with mud or covered with sand to such an extent that inspection and servicing will be seriously hampered. However, the bulldozer should not be washed or wiped thoroughly clean, since certain types of defects such as cracks, leaks, and loose or shifted parts or assemblies are more evident if the surfaces are slightly soiled or dusty.

c. **SOURCES OF ADDITIONAL INFORMATION.** If instructions other than those contained in the general procedures in *d* below, or the specific procedures in *e* below, are required for the correct performance of

a preventive maintenance service or for the correction of a deficiency, other sections of the bulldozer operator's manual pertaining to the item involved should be followed or a designated individual in authority should be consulted.

d. GENERAL PROCEDURES. These general procedures are basic instructions which are to be followed when performing the services on the items listed in specific procedures.

Note. The organizational maintenance personnel must be thoroughly trained in these procedures so that they will apply them automatically.

(1) When new or overhauled subassemblies are installed to correct a deficiency, care must be taken to see that they are clean, correctly installed, and properly lubricated and adjusted.

(2) The general inspection of each item applies also to any supporting member or connection, and usually includes a check to see whether or not the item is in good condition, correctly assembled, secure, or excessively worn.

(3) When conditions make it difficult to perform all of the preventive maintenance procedures at one time, these services can sometimes be handled in sections, planning to complete all operations within the week if possible. All available time at halts and in bivouac areas must be utilized, if necessary, to assure that the maintenance operations are completed.

e. SPECIFIC PROCEDURES. The procedures for performing each item in the semimonthly and monthly maintenance procedures are described in the chart below. Each page of the chart has two columns at its left edge corresponding to the monthly and the semimonthly maintenance, respectively. Very often it has been found that a particular procedure does not apply to both scheduled maintenances. In order to determine which procedure to follow, look down the column corresponding to the maintenance due, and wherever an item number appears, perform the operations indicated opposite the number.

Note. The procedure numbers contained in the chart below apply only to the bulldozer and do not refer to the preventive maintenance service and technical inspection work sheet required for the medium tank M4 series.

Maintenance		
Monthly	Semimonthly	
1	1	<i>Blade, bits, and sidearms.</i> Inspect the blade and sidearms to see that they are in good condition and that all assembly welds are secure. See that center cutting edge and side bit attaching bolts are present and secure.
2	2	<i>Suspension mounting brackets, pivot pins, pivot bearings, and bearing latches.</i> Examine suspension mounting brackets, pivot pins, pivot bearings, and bearing latches to see that they are in good condition, correctly assembled, and securely mounted. Be sure that pivot bear-

Maintenance
Monthly Semimonthly

- ings open and close properly and that bearing latches hold bearings securely in closed position.
- 3 3 *Tripod, jettisoning assembly, and cables.* Inspect tripod to see that assembly welds are intact and that mounting pins are present and secure. Be sure that jettisoning device is properly assembled and mounted and that it operates properly. Examine cables to see that they are not frayed and that all cable connections are secure.
- 4 4 *Hydraulic jack and jack support bracket.* Examine hydraulic jack support bracket to see that it is in good condition and that all mounting pins and cap screws are present and secure. Be sure that pin hole in upper end of jack piston and jack connecting pin are not excessively worn.
- 5 5 *Outside hydraulic pipe lines, hose, and guard.* Inspect accessible outside hydraulic pipe lines and hose to see that they are not damaged and that all connections are secure and not leaking. Be sure that the pressure hose to jack is not chafing against the brackets. See that pipe line guard is securely mounted.
- 6 6 *Reservoir, reservoir mountings, pipe lines, and hose.* Examine reservoir, pipe lines, and hose to see that they are in good condition and that there are no indications of leaks. See that all pipe lines, hose, and mountings are secure. Remove reservoir filler cap and see that the screen is clean, that the hydraulic oil is at the proper level, and that the breather vents in filler cap are not clogged.
- 7 7 *Hydraulic pump and pump mountings.* Inspect hydraulic pump and pump mountings to see that they are in good condition, that all assembly and mounting cap screws are secure, and that pump and pump connections are not leaking.
- 8 8 *Control valve, control lever, drive belts, and belt guard.* Examine control valve and control levers to see that they are in good condition and that the levers operate the valve without looseness or binding. Be sure drive belts are not frayed, cracked, or worn and that they are adjusted to have a 1-inch deflection halfway between pulleys. See that the belt guard is securely mounted.
- 9 9 *Leaks.* Start engine and, while raising the blade, examine all lines during this operation for indications of leaks. Lower the blade, place control lever in neutral (hold) position, and stop engine.
- 10 10 *Jettisoning control lever and mountings.* Examine jettisoning control lever to see that it operates properly and that the mountings are secure. Be sure jettisoning cable is securely attached to control lever.
- 11 11 *Spare oil supply.* Check whether supply of the listed spare oil is present and properly stowed. This supply should be maintained at all times.

Maintenance		
Monthly	Semimonthly	
12	12	<i>Lubrication.</i> Lubricate the entire bulldozer unit according to instructions contained in lubrication order. Be sure lubrication fittings are in good condition and secure.
13	13	<i>Modifications (MWO's completed).</i> Check unit thoroughly to be sure all modification work orders have been completed and entered on WD AGO Form 478. Enter any modifications or major unit assembly replacements made at time of this service.
14	14	<i>Tools.</i> Be sure all special tools for the bulldozer are present, in good condition, and properly stowed.

Section XII. TROUBLE SHOOTING

37. General

This section contains trouble shooting information and tests which can be made to help determine the causes of some of the troubles that may develop in the bulldozers M1 and M1A1. Each paragraph contains a list of vehicle or unit symptoms. The tests which must be made to determine which defective item is responsible for the trouble are explained after each vehicle or unit symptom. Instructions for remedy of the defective item are given either in this section or by reference to another paragraph in the manual.

38. Hydraulic System

a. BLADE FAILS TO LIFT. (1) Check oil level in reservoir and if below the level mark on the oil gage, fill reservoir to level mark.

(2) Inspect hydraulic lines and connections for leaks. Tighten connections and repair or replace lines as necessary.

(3) Examine packing nuts on the three-stage jack and packing gland on the one-stage jack for excessive oil leakage. Tighten packing nuts or gland.

(4) Test the relief valve pressure (par. 56*b*). If pressure is incorrect, adjust valve. If correct reading cannot be obtained, check for obstruction in hydraulic line between oil reservoir and pump (step (5) below). Replace control valve assembly (par. 59) if there is no obstruction.

(5) Drain reservoir and disconnect hose between reservoir and pump. Remove existing obstructions and install hose.

(6) Remove pipe lines, connections, and hose between control valve and jack. Remove existing obstructions and install pipe lines, connections, and hose.

(7) If the inspections in steps (1) through (6) above do not correct the trouble and the hydraulic system pressure is below normal,

a worn or damaged pump is indicated. Replace pump assembly (par. 57).

b. **BLADE SETTLES STEADILY WITH CONTROL VALVE LEVER AT "HOLD."** (1) Check jack, hydraulic lines and connections, and control valve for signs of escaping oil.

(2) If trouble source is not visible, replace control valve, pump, then jack in turn.

39. Tripod Assembly

If jack connecting pin fails to remain in engaged position, check for broken connecting pin spring. Replace jack connecting pin spring (par. 48).

40. Jettisoning Assembly

a. **JACK CONNECTING PIN FAILS TO RELEASE.** Check for broken jettisoning cable to jack connecting pin. Connect or replace jettisoning cable from cable drum to jettisoning arm in tripod.

b. **SIDEARM PIVOT MOUNTINGS FAIL TO OPEN WHEN JETTISONING LEVER IS OPERATED.** Examine the jettisoning cable from cable drum to sidearm pivot mounting. The cable may be too long, disconnected, or broken. Connect, adjust, or replace jettisoning cable from sidearm pivot mounting latches to cable drum in tripod.

41. Blade Assembly

a. **BLADE DOES NOT DIG TO PROPER DEPTH.** Check bottom edge of blade for wear caused by failure to replace cutting edge at proper time. If worn, notify higher authority.

b. **UNABLE TO KEEP BLADE LOADED WHEN MOVING MATERIAL CONSIDERABLE DISTANCE.** This trouble is due to failure to provide channel for blade to operate in. Follow same pathway each time so material will windrow on each end of blade and hold blade full.

Section XIII. BLADE, TRIPOD, AND SUSPENSION MOUNTING BRACKETS

42. Blade Assembly

a. **DESCRIPTION.** The bulldozer blade is a welded steel construction consisting of a bulldozer blade with two sidearms which straddle the tank. The bottom of the blade has a removable hardened steel center edge and a bit on each corner and side (fig. 51). The end of each sidearm is constructed with a latch which holds the blade and sidearm on the mounting bracket pivot (fig. 52). A jettisoning cable is attached to each latch at the end of the sidearms, and runs

through the sidearms into the tripod assembly which is fastened at the rear of the blade with three connecting pins. A lifting hook is provided in each corner in back of the blade. A spare parts case is attached in the right-hand corner on back of the blade.

b. REMOVAL. Jettison the blade from tank (par. 18c). Separate tripod from blade (par. 44).

c. INSTALLATION. Install tripod to blade and attach the jettisoning cables (par. 45). Mount the tripod and blade on the tank (par. 12).

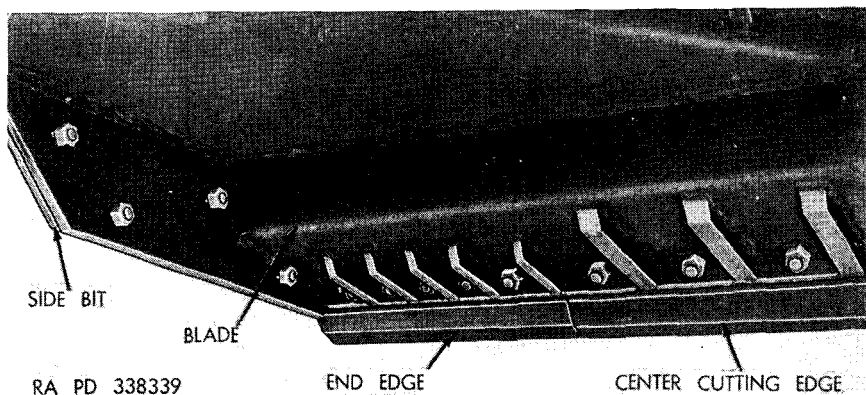

Figure 51. Cutting edges mounted on blade—bottom view.

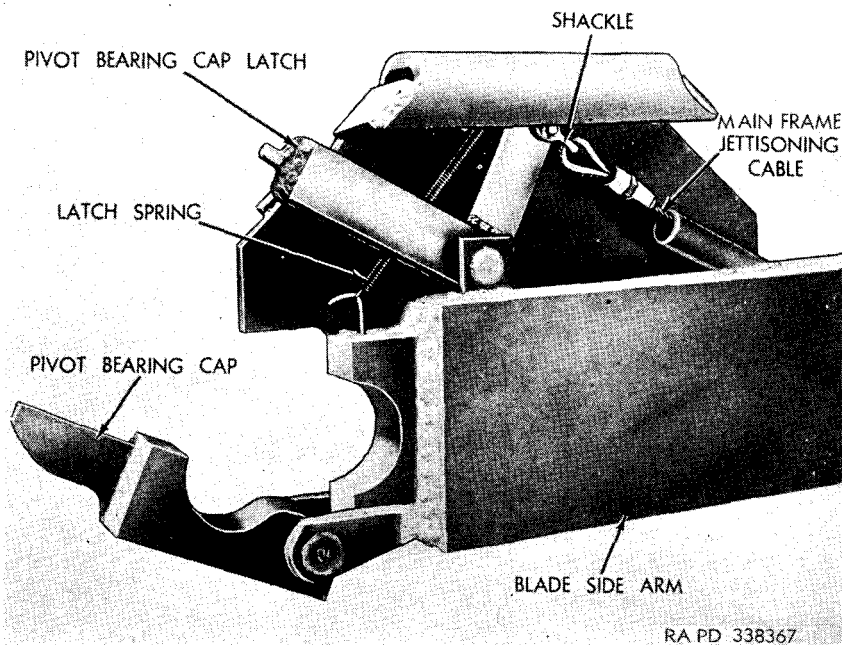

Figure 52. Jettisoning cable arrangement in side arm end.

43. Cutting Edge and Bits

a. REMOVAL. Remove the end, center cutting edge, or side bit from the blade by removing their respective nuts and bolts (fig. 51).

b. INSTALLATION. Install the end, center cutting edge, or side bit to the blade, and secure with bolts and nuts.

44. Tripod Assembly (fig. 53)

a. DESCRIPTION. The tripod assembly is a tubular construction with steel plate welded all around, leaving an opening at the rear for the hydraulic jack. The tripod is connected to the rear of the blade with three pins. The jettisoning cable drum mounted on a cross member has three jettisoning cables attached (one cable from the hydraulic jack connecting pin and two cables from sidearm latches) running through the tube in tripod and sidearms. The drum is actuated by pulling the release jettisoning cable which is attached to the drum arm. The hydraulic jack connecting pin has a spring arrangement to keep the pin engaged.

b. REMOVAL. Jettison the blade together with tripod from the tank (par. 18c). Remove the two screws on the inside of the cable drum which fasten the two sidearm jettisoning cables to the drum.

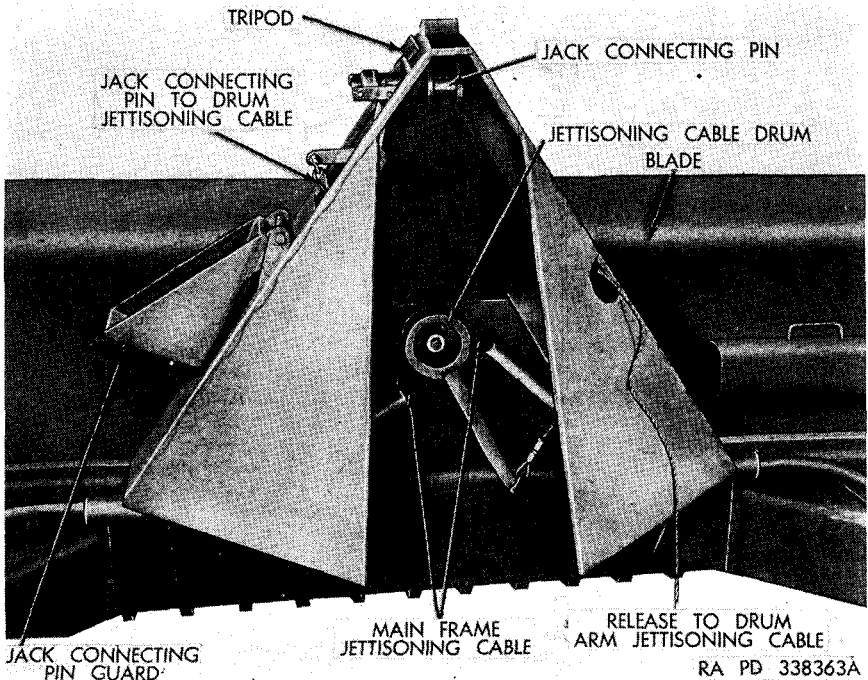
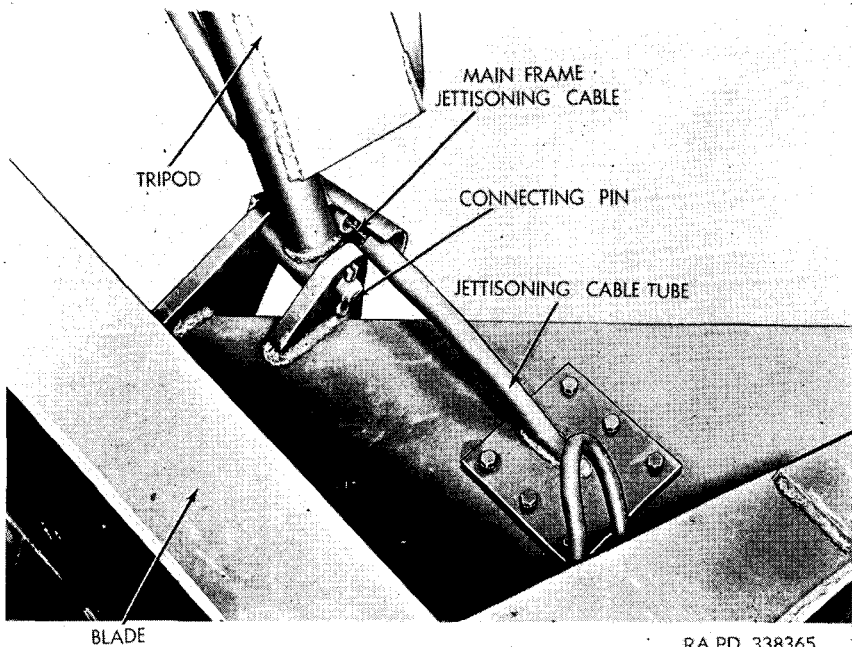

Figure 53. Tripod assembly—rear view.



RA PD 338365

Figure 54. Tripod to blade—lower connections.

Separate tripod assembly from the blade by removing three pins held by cotter pins (figs. 9 and 54).

c. INSTALLATION. Raise the tripod assembly in position on rear of blade and secure with three pins and cotter pins. Thread the jettisoning cable from each sidearm through the respective guide tube on the tripod. Fasten each cable in its position on the circumference of the cable drum with a bolt and lock washer. Mount the bulldozer blade and tripod on tank (par. 12).

45. Jettisoning Cables

a. MAIN FRAME JETTISONING CABLE. (1) *Removal.* Remove screw securing the main frame jettisoning cable to cable drum (fig. 53). Remove latch spring from latch (fig. 52). Remove shackle which connects the main frame jettisoning cable to the pivot bearing cap latch and pull out the jettisoning cable.

(2) *Installation.* Thread the main frame jettisoning cable through the tube at the rear of sidearm. Remove jettisoning cable tube fastened to blade with six screws (fig. 54). Fish out the cable and thread it through the tube and the tube in tripod. Fasten the jettisoning cable tube to blade. Connect cable at the rear to the pivot bearing cap latch with a shackle (fig. 52), and install latch spring.

Fasten the front end of cable in position inside the drum with a cap screw.

Note. When tightening main frame cable, make sure that the latch is down and that the drum is against the stop in fully released position with no tension on the cable.

b. RELEASE TO DRUM ARM JETTISONING CABLE (fig. 53). (1) *Removal.* Disconnect the cable at the drum arm held with a shackle and remove the cable.

(2) *Installation.* Connect the cable at the drum arm with a shackle and thread the cable over the pulley on the right side of tripod and out of the tripod opening.

c. JACK CONNECTING PIN TO DRUM JETTISONING CABLE (fig. 53). (1) *Removal.* Remove shackle which connects the jettisoning cable to jack connecting pin arm. Remove the screw that secures the cable to the drum, freeing the cable.

(2) *Installation.* Connect the jack connecting pin jettisoning cable with a shackle to the jack connecting pin arm. At the other end, connect the cable on the inside of the drum with a cap screw, making sure that the tension is off the cable when drum rests against the stop.

46. Jettisoning Cable Drum (fig. 53)

a. DESCRIPTION. The jettisoning cable drum is mounted on the center of the cross plate which connects the tripod side bars. The jettisoning cable from the pivot arm, as well as the jettisoning cables which are connected to the sidearm pivot latches, are clamped to the cable drum. An arm welded to the outside flange of the drum is connected to the jettisoning operating cable. As the drum moves in response to the movement of the jettisoning lever in the tank, the cable attached to the pivot arm pulls the jack connecting pin in the released position. At the same time, the cables attached to the pivot latches on the sidearms open these latches, allowing the entire bulldozer to be jettisoned.

b. REMOVAL. Remove three cap screws and flat washers that clamp the cables to the drum. Remove the cotter pin and shackle pin from the jettisoning cable drum arm. Remove nut from drum mounting cap screw and remove cap screw, flat washer, and the drum spacer. Remove the jettisoning cable drum.

c. INSTALLATION. Install the jettisoning cable drum on tripod and secure with spacer, flat washer, and cap screw. Install lock nut on end of cap screw. Install the release jettisoning cable to the cable drum arm held by a shackle. Secure the three remaining jettisoning cables on inside of the cable drum with three cap screws and washers.

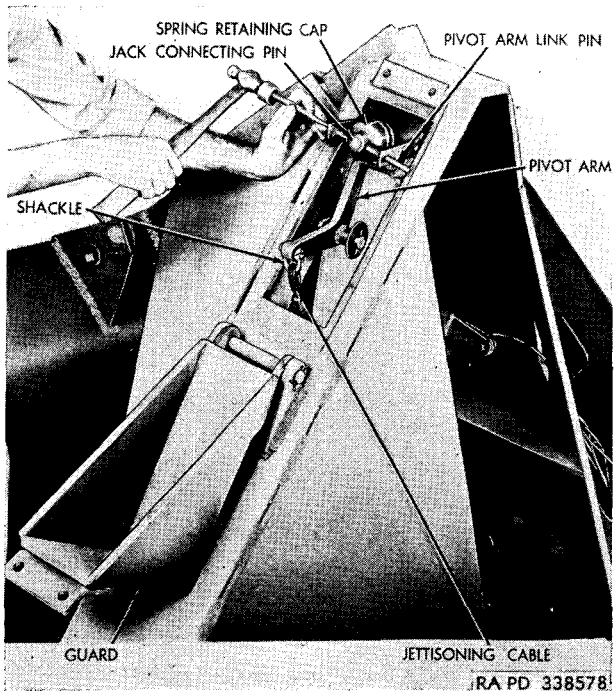

Figure 55. Removing pivot arm link pin.

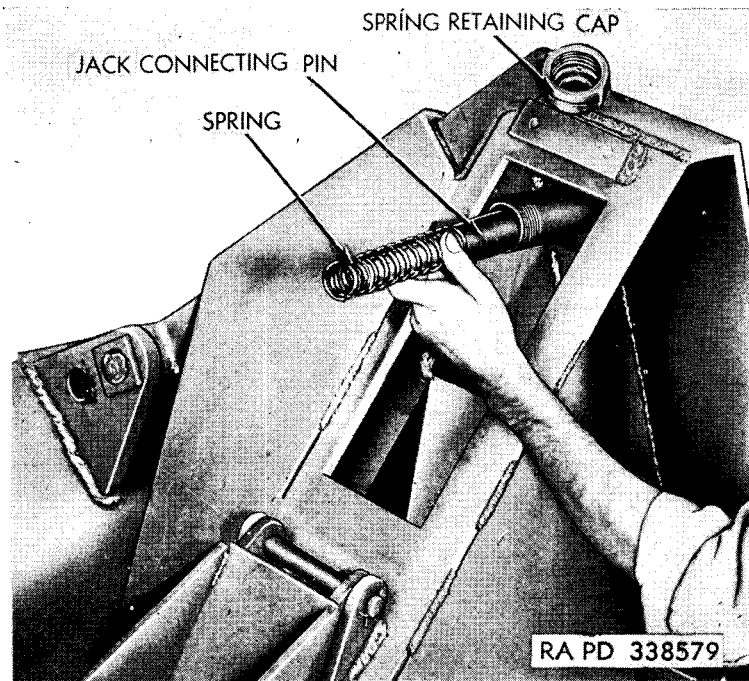

Figure 56. Removing jack connecting pin and spring.

47. Jack Connecting Pin Pivot Arm

a. DESCRIPTION. The pivot arm assembly is mounted on a pin welded to the upper left side of tripod bar (fig. 55). The lower end of the pivot arm is connected to the jettisoning cable by a shackle and shackle pin. The upper end of the pivot arm is connected by pin and links to the outside end of the jack connecting pin. When the jettisoning cable is pulled, the lower end of the pivot arm moves downward and through the connecting linkage, pulling the jack connecting pin in the released position.

b. REMOVAL. Open the jettisoning pivot arm guard by removing two cap screws. Remove the cotter pin and shackle pin from the lower end of the pivot arm. Remove the cotter pin and link pin from upper end of pivot arm. Remove the cotter pin and washer from arm mounting pin and slide the pivot arm off mounting pin.

c. INSTALLATION. Install pivot arm on the pivot arm mounting pin and secure with washer and cotter pin. Attach pivot arm link to jack connecting pin with link pin and cotter pins. Attach lower end of pivot arm to jettisoning cable held with shackle and pin. Close the jack connecting pin guard and secure with two cap screws.

48. Jack Connecting Pin

a. DESCRIPTION. The jack connecting pin assembly is located at the top of the tripod and is accessible only with the jettisoning arm guard open (fig. 53). A cylindrical pin and spring housing is welded to the left inside wall at the upper end of the tripod. The outside end of the pin and spring housing is threaded to fit a spring retainer cap. The pin is spring-loaded to keep the jack connecting pin constantly engaged until the jettisoning of the bulldozer blade is desired.

b. REMOVAL. Remove two 1/2-inch cap screws from the upper edge of the jettisoning arm guard and open the guard. Remove cotter pin and link pin from end of jack connecting pin (fig. 55). Unscrew the spring retaining cap and remove the spring and jack connecting pin (fig. 56).

c. INSTALLATION. Install the jack connecting pin and spring inside the pin housing on tripod and install spring retaining cap on housing (fig. 56). Connect the pivot arm link to the jack connecting pin with a link pin and secure with cotter pins. Close guard and secure with two cap screws (fig. 55).

49. Suspension Mounting Brackets and Attachments

a. DESCRIPTION. The suspension mounting brackets are welded steel constructions which extend from the front to the second sus-

pension. On the vertical suspensions, the mounting bracket is attached with two cap screws to the new mounting block on the front suspension, four bolts and nuts to the angle support, and three nuts to the second suspension (fig. 41). The bulldozer M1 mounting brackets have a pivot welded to the lower rear edge which engages with the pivot bearing on the rear end of the sidearms of the blade. The bulldozer M1A1 vertical suspension mounting bracket is adaptable for standard vertical suspension and spaced vertical suspension tanks by bolting the respective adapter pivot to the bracket (fig. 43). The bulldozer M1A1 horizontal suspension mounting bracket has the pivot welded on the bracket. The horizontal suspension mounting bracket is attached to front and second suspension with two long bolts and spacers apiece. Slack between the suspensions is taken up by the locking screw and nut provided for on the back of the bracket.

b. VERTICAL SUSPENSION MOUNTING BRACKETS AND ATTACHMENTS (BULLDOZERS M1 AND M1A1) (fig. 40). (1) *Removal.* Remove the two cap screws securing the mounting bracket to the front suspension. Remove the three nuts and lock plate which secure the bracket to the second suspension. Support the weight of the mounting bracket and remove four bolts and nuts securing bracket to angle support, releasing the mounting bracket. Remove angle support held to the front of the second suspensions with two bolts. Remove the mounting block fastened to the front suspension with three nuts and locking plate.

(2) *Installation.* Install the vertical suspension mounting brackets, mounting blocks, and angle supports on the tank (par. 11).

c. HORIZONTAL SUSPENSION MOUNTING BRACKETS AND ATTACHMENTS (BULLDOZER M1A1) (figs. 42 and 43). (1) *Removal.* Loosen the lock nut and back off the locking screw at the rear of the horizontal mounting bracket. Support the weight of the mounting bracket and remove the four long bolts and spacers which secure the bracket to front and second suspension, releasing the mounting bracket. Remove mounting block fastened to the front suspension with three nuts and lock plate.

(2) *Installation.* Install the horizontal mounting bracket and mounting block on the tank (par. 11).

Section XIV. JACK SUPPORTING GROUP AND PIPE GUARD

50. Jack Support Frame (Bulldozer M1) (fig. 34)

a. DESCRIPTION. The jack support frame is a welded steel construction with two side plates cut to the contours of front of tank.

The cross member has a large pin on each side which fits, through a locking clamp and side plate, into the eye of the tank towing lug on the differential housing. The jack supporting side plates are welded at the bottom to the cross member and held separated at the top with a half-round metal strap. The jack connecting pin passes through the jack supporting side plates. When the pin is in place, its square head fits against a stop to keep the pin from turning. A grease fitting is provided in the head of the pin. The bulldozer M1 has two jack support frames: one fits the one-piece differential housing with the narrow towing lug span, and the other fits the one-piece differential housing with the wide towing lug span. The latter also fits the three-piece differential housing. The eccentric end of jack support frame is used on the three-piece differential housing. The cutaway clearance in these pins is to clear the differential housing flanges.

b. REMOVAL. Jettison the blade from the tank (par. 18*e*). Disconnect the hydraulic jack hose connection and remove jack from the jack support frame (par. 61). Raise the lower pipe guard and prop it up temporarily (fig. 33). Loosen the clamp bolts on the jack support frame pins (fig. 34). Support the weight of the jack support frame and tap the pins out of the towing lug eyes, freeing the jack support frame.

c. INSTALLATION. Install jack support frame on tank, install hydraulic jack, and connect hydraulic jack hose (par. 61). Mount the bulldozer blade on tank (par. 12).

51. Pipe Guards (Bulldozer M1) (fig. 33)

a. DESCRIPTION. Pipe guards are welded armor steel coverings to protect the external hydraulic piping and hose from snipers. The upper pipe guard consists of two sections, adjustable to two widths. A slot in the upper pipe guard permits clearance for jettisoning cable. The lower pipe guard houses a spare parts box which is made accessible by raising the lower guard slightly off the tank.

b. REMOVAL. Remove the lower pipe guard from the tank by removing the two bolts and nuts which fasten the lower to the upper pipe guard. Remove the upper pipe guard held to the tank by two nuts.

c. INSTALLATION. Install upper and lower pipe guards on the tank (par. 10).

52. Pipe Guard (Bulldozer M1A1) (figs. 32 and 33)

a. DESCRIPTION. The pipe guard is a welded armor steel covering which protects the external hydraulic pipe and supports the upper end of the jack support. The pipe guard consists of two sections

adjustable to two widths. A slot is provided to permit clearance for the jettisoning cable.

b. REMOVAL. Jettison the blade from the tank (par. 18*c*). Support the weight of the jack and jack support, remove the pin at the top (fig. 39), and disconnect jack oil hose. With the lower end of the jack support attached to the jack side support, lower the jack support to the ground. Remove the pipe guard held to the tank by four nuts (fig. 32).

c. INSTALLATION. Install the pipe guard on the tank (par. 10). Raise the jack and jack support, pivoting it on the jack side support pins, and couple the jack hose to piping. Connect jack support to the pipe guard with a pin. Mount the bulldozer blade on the tank (par. 12).

53. Jack Support (Bulldozer MIAI) (fig. 33)

a. DESCRIPTION. The jack support assembly is constructed of welded armor plate. In addition to providing the means of supporting the jack and jack box, the support shields the hydraulic flexible oil hose and piping. The upper end of the support is attached to the upper pipe guard by a pin. The lower rear of the jack support is connected to the jack side support by a pin.

b. REMOVAL. Jettison the blade from the tank (par. 18*c*). Remove hydraulic jack and jack box from jack support (par. 61). Support the weight of the jack support with hoist and remove top connecting pin. Lower the jack support and remove the pin which connects the support to jack side support, freeing the jack support.

c. INSTALLATION. Connect the lower end of jack support to the jack side support with a pin, then connect the upper end to the pipe guard with another pin. Secure each pin with a cotter pin. Install the hydraulic jack and jack box in the jack support (par. 61). Mount the bulldozer blade on the tank (par. 12).

54. Jack Side Support (Bulldozer MIAI) (figs. 33 and 35)

a. DESCRIPTION. The jack side support is a welded box structure with four ears. The support is attached to the towing lugs on the differential housing of the tank with two pins. Each bulldozer set consists of three types of jack side supports to accommodate the different differential housings: one side support fits the one-piece differential housing with narrow towing lug span, another jack side support fits on a one-piece differential housing with wide towing lug span, and the third jack side support fits on a three-piece differential housing.

b. REMOVAL. Jettison the blade from the tank (par. 18*c*). Remove the hydraulic jack from the jack support (par. 61). Remove the jack support from the tank (par. 53). Remove the two pins which

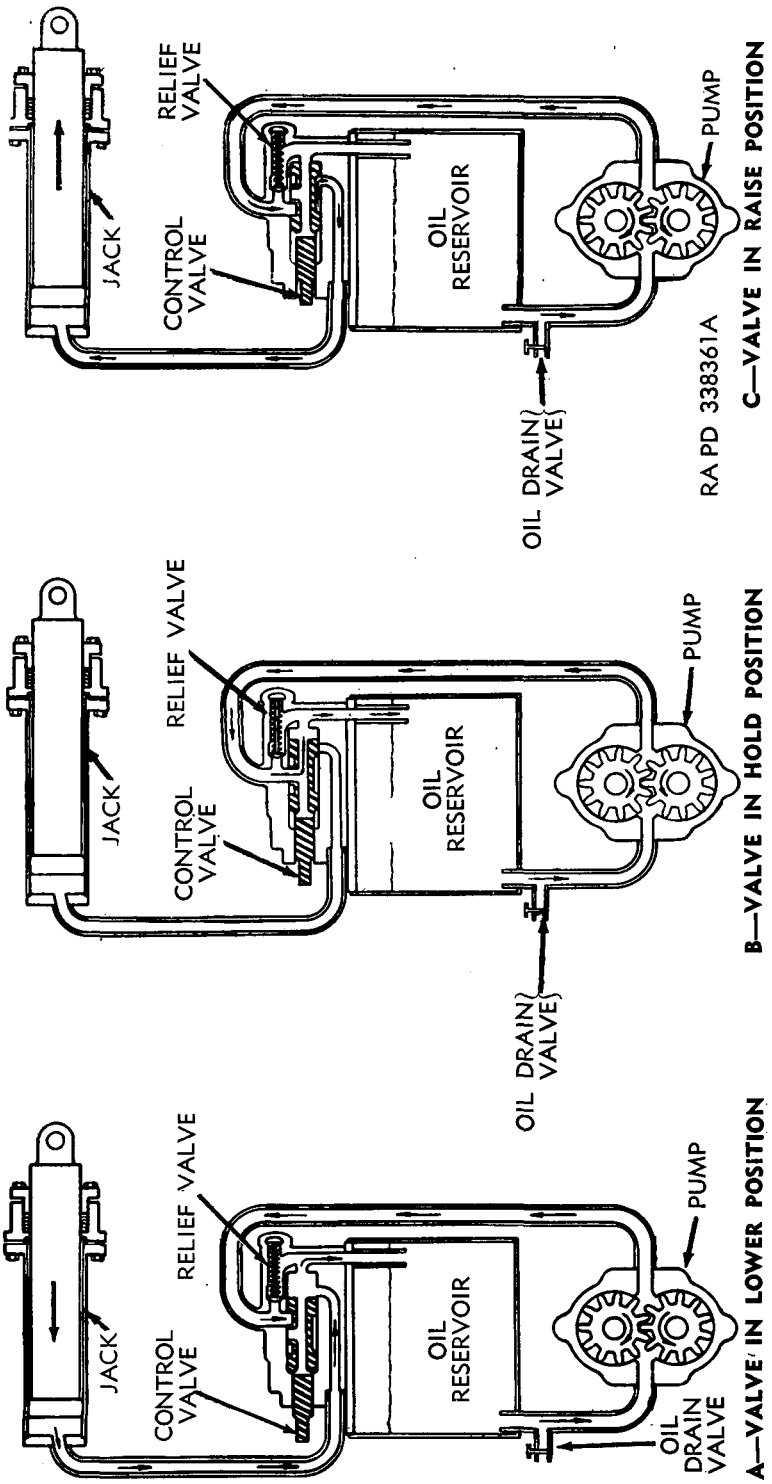

Figure 57. Diagram of hydraulic system functions.

secure the jack side support to the towing lugs, releasing the jack side support.

c. **INSTALLATION.** Install the jack side support to the towing lugs with two pins. Install jack support to front of tank (par. 53). Install the hydraulic jack and jack box in the jack support (par. 61). Mount the bulldozer blade on the tank (par. 12).

Section XV. HYDRAULIC SYSTEM

55. Description and Data

a. **DESCRIPTION.** The bulldozer hydraulic system consists of four principal parts: pump, control valve, oil reservoir, and the hydraulic jack (fig. 57). The oil reservoir mounted on the transmission stores the oil for the system (figs. 5 and 6). The pump, driven by belts from the propeller shaft, builds up approximately 1,300 pounds pressure per square inch, and forces the oil through the control valve against the relief valve to the hydraulic jack. The relief valve, which is an integral part of the control valve, governs the pressure in the system. If control lever is allowed to remain in "raise position" or "lower position" after the jack has reached the end of its travel in either direction, the pressure immediately begins to build up because of the oil being forced into the system by the pump. When this pressure exceeds the relief valve setting, it compresses the relief valve spring, allowing the valve to open and bypass the excess oil pressure back into the oil reservoir. When the control lever is operated to "raise position," the control valve allows the oil pressure to pass to the jack. The pressure within the jack converts the oil pressure into mechanical force required for lifting the bulldozer blade.

b. **DATA.**

Control valve -----	Model CV-11
Hydraulic system oil capacity -----	9 gal
Jack (bulldozer M1) -----	one-stage type
Jack (bulldozer M1A1) -----	three-stage type
Pump (gear type) -----	Model P-11
Pump maximum pressure (at 1500 rpm of tank engine)	1,300 lb per sq in.
Relief valve setting (bulldozer M1) -----	800 lb per sq in.
Relief valve setting (bulldozer M1A1) -----	1,000 lb per sq in.

56. Hydraulic System Pressure

a. **GENERAL.** Proper pressure must be maintained in the hydraulic system in order to operate the bulldozer blade. The pressure in bulldozer M1 must be 800 pounds per square inch and in bulldozer M1A1, 1,000 pounds per square inch.

b. TESTING.

Note. Pressure gage is provided with bulldozer M1A1 only.

Stop engine and move the control lever forward, lowering the blade. This will permit the oil to return from the jack and oil line to the oil reservoir. Remove the 1/8-inch pipe plug from the tee fitting in the line between the pump and control valve and install pressure gage at tee fitting (fig. 58). With relief valve cap in place, start tank engine and place control lever in "raise position." When the jack has reached the extreme end of travel, the relief valve will bypass the oil into reservoir, relieving the excess pressure, and the gage reading will indicate oil pressure in the hydraulic system. To obtain correct pressure as indicated in *a* above, adjust the relief valve (*c* below). When the testing of the oil pressure is completed, stop engine and place control lever to "lower position" so that oil pressure returns to reservoir. Remove gage and install pipe plug.

c. ADJUSTING. If the hydraulic pressure tests incorrectly, stop tank engine and remove the relief valve cap and gasket (fig. 58). Remove the pin that locks the adjusting nut in the relief valve cage and turn the adjusting nut in the direction desired. A suitable tool for making the above adjustment is illustrated in figure 61. Pressure will increase approximately 50 pounds for each full turn clockwise of adjusting nut, and decrease 50 pounds for each full turn counterclockwise.

Note. Install lock pin in adjusting nut and securely tighten relief valve cap and gasket before engine is started.

Repeat test as instructed in *b* above.

57. Pump Assembly

a. DESCRIPTION. The pump is a belt-driven, gear-type hydraulic pump capable of building 1,300 pounds per square inch pressure at approximately 1,500 revolutions per minute of the tank engine. The pump is mounted on a bracket and mounting plate to the rear of the transmission (fig. 27).

b. REMOVAL. Drain the oil from reservoir, and disconnect one pump oil line at the bottom of the reservoir and the other at the union fitting above the control valve (figs. 5 and 6). Remove pump belt guard from pump mounting plate held with two cap screws. Loosen the nut and bolt which locks the pump bracket to the mounting plate, and back off belt adjusting screw sufficiently to allow belts to be removed from pump pulley (fig. 27). Remove socket-head setscrew in hub of pulley and remove pulley from pump shaft (fig. 25). Remove pump assembly which is secured to pump bracket with four bolts and nuts. Remove pump bracket by removing cotter pin and nut from hinge bolt.

c. INSTALLATION. Install pump bracket on pump mounting plate and secure with nut and lock washer. Install pump on pump bracket

OIL PRESSURE GAGE
RELIEF VALVE CAP

RELIEF VALVE
ADJUSTING NUT

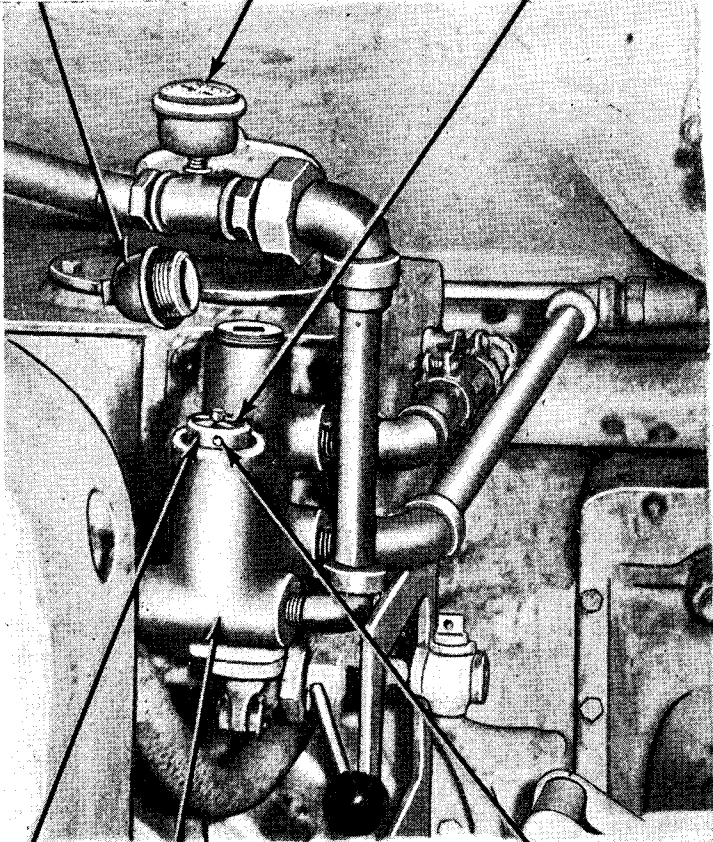

CONTROL VALVE
RELIEF VALVE CAGE

ADJUSTING NUT
LOCK PIN

RA PD 338421A

Figure 58. Relief valve cap removed.

and secure with four bolts and nuts (fig. 27). Connect the two hoses to pump. Install the belts on pump pulley and adjust belt tension (par. 58). Install pump drive belt guard and fasten to pump mounting plate with two cap screws.

58. Pump Drive Belts and Pulley

a. REMOVAL. Remove pump belt guard which is held to pump mounting plate with two cap screws (figs. 27 and 30). Loosen the nut and bolt which locks the pump bracket to the mounting plate,

and back off belt adjusting screw sufficiently to allow belts to be removed from pump pulley. Remove generator and generator cradle bracket (par. 9*d*). Remove generator drive pulley (par. 9*e*). Remove the two pump drive belts from propeller shaft.

b. INSTALLATION. Install the two pump drive belts on the propeller shaft and install the generator drive pulley (par. 9*h*). Install the generator cradle bracket on the transmission (par. 9*p*). Adjust tension of pump drive belts (par. 9*q*). Install generator in cradle (par. 9*s*). Install pump belt guard on pump mounting plate (par. 9*t*).

59. Control Valve Assembly and Connections

a. DESCRIPTION. The control valve mounted on the oil reservoir consists of a cast-iron housing containing a control valve spool and the relief valve assembly. The control valve spool is actuated by operating the control lever (fig. 23). The relief valve has a conical-shaped plunger which is held down by a spring and adjusting nut (fig. 58). The adjustment of the relief valve determines the pressure maintained in the hydraulic system.

b. REMOVAL. Drain the oil reservoir. Uncouple the union in the control valve to jack line under the headlight outlet (fig. 30). Uncouple the union in the control valve to pump line. Disconnect the control valve to oil reservoir line by loosening the clamps securing the hose. Remove the cotter pin and connecting pin from control lever linkage at bottom of control valve (fig. 23). Remove four nuts and lock washers from the studs which secure the control valve to reservoir, and remove control valve and two gaskets from studs on oil reservoir.

c. INSTALLATION. Install the two control valve gaskets and the control valve over the studs on the oil reservoir and secure with four nuts and lock washers. Couple the control valve to reservoir line with a short hose and secure hose with two clamps. Connect the control lever linkage to control valve spool (fig. 23). Couple the control valve to pump line union. Install control valve to jack line hose if removed, and couple the union under the headlight outlet (fig. 28). Fill hydraulic system with oil.

60. Oil Reservoir

a. DESCRIPTION. The oil reservoir which is mounted on the transmission (figs. 5 and 6) consists of a welded steel tank with baffles, and a screen in the filler neck (fig. 59). Air enters the oil reservoir through the ports in the breather and filler cap, wire screen, and element. The control lever and linkage is welded to the lower rear of the oil reservoir.

b. CLEANING. (1) *Breather and filler cap, element, and screen.* Unscrew the breather and filler cap and oil gage and remove cap

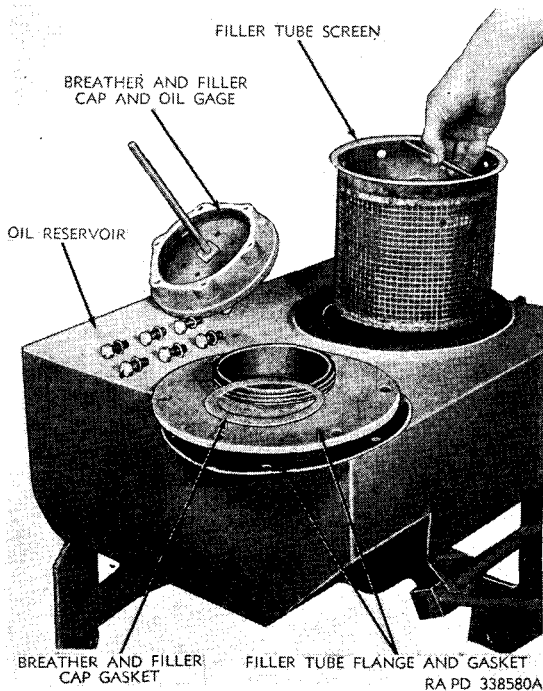

Figure 59. Removing filler tube screen.

and gasket from the filler tube flange (fig. 59). Remove nut and washer securing the oil gage to cap and remove oil gage, cap bottom, element, and screen (fig. 60). Clean all parts in dry-cleaning solvent and dry with compressed air. Install the screen, element, cap bottom, and oil gage in the cap and secure with washer and nut.

(2) *Filler tube screen.* Remove the breather and filler cap from filler tube flange ((1) above). Remove filler tube flange and gasket held to oil reservoir with six cap screws (fig. 59). Remove the filler tube screen from the oil reservoir. Clean the filler tube screen in dry-cleaning solvent and dry with compressed air. Install the filler tube screen in oil reservoir. Install the breather cap on filler tube flange ((1) above).

c. REMOVAL. Remove control valve from oil reservoir (par. 59). Remove the oil reservoir from transmission held by two cap screws at the left side (fig. 5) of transmission and four cap screws on the right side of transmission (fig. 6). Place the oil reservoir in turret, raise it through the turret hatch, and remove the reservoir from the tank.

d. INSTALLATION. Install oil reservoir on transmission (par. 9*k*). Install control valve on oil reservoir (par. 59).

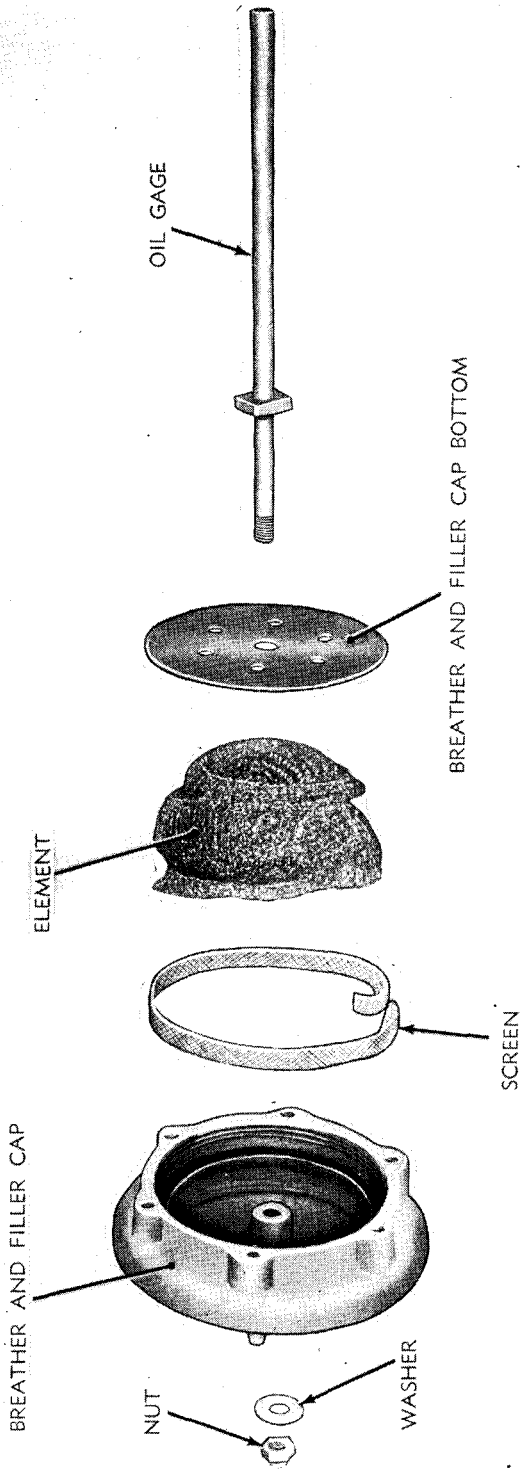

RA PD 338581A

Figure 60. Breather and filler cap and oil gage assembly.

61. Hydraulic Jack

a. DESCRIPTION. The hydraulic jack is a telescopic-type jack. The jack on bulldozer M1 is a one-stage type (fig. 36), and the jack on bulldozer M1A1 is a three-stage type (fig. 37). The main or lower section is mounted to jack support (fig. 33). The hydraulic line enters the lower section of the jack. The end or center section telescopes in the main or lower section, and both the main, center, and end sections are provided with packing and packing glands to prevent leakage. The end section has a hole through its upper end for the purpose of connecting the jack to the tripod.

b. HYDRAULIC JACK (BULLDOZER M1). (1) *Removal.* Jettison the blade and tripod from tank (par. 18c). Push the control lever forward to the "lower position," so that the oil pressure in the hydraulic line passes into the oil reservoir. Raise the lower pipe guard and uncouple the jack hose from the jack piping. Lower the lower pipe guard. Remove the hydraulic jack held to jack support frame with connecting pin (fig. 36).

Caution: Be sure to protect the disconnected end of hydraulic line with a clean cloth to prevent dirt from entering.

(2) *Installation.* Install hydraulic jack on jack support frame (par. 10e).

c. HYDRAULIC JACK (BULLDOZER M1A1). (1) *Removal.* Jettison the blade and tripod from tank (par. 18c). Push the control lever forward to the "lower position," so that the oil pressure in the hydraulic line passes into the oil reservoir. Support the weight of the jack and jack support with a chain hoist, and remove the upper connecting pin which secures the jack support to the pipe guard. Uncouple the jack hose from jack piping (fig. 39). Connect the jack support to the pipe guard with the connecting pin. Support the weight of the jack with a hoist. Remove jack together with the jack box by removing jack box connecting pin held in place with a cotter pin (fig. 38).

Caution: Be sure to protect the disconnected hydraulic line with clean cloth to prevent dirt from entering.

(2) *Installation.* Install hydraulic jack and jack box on jack support (par. 10f).

PART FOUR AUXILIARY EQUIPMENT

Section XVI. GENERAL

62. Scope

No auxiliary equipment is issued for use with the bulldozer.

PART FIVE

REPAIR INSTRUCTIONS

Section XVII. GENERAL

63. Scope

These instructions are published for the information and guidance of personnel responsible for field maintenance on this equipment. They contain information on the maintenance which is beyond the scope of the tools, equipment, or supplies normally available to using organizations.

Section XVIII. SPECIAL TOOLS

64. List of Special Tools

a. PURPOSE. No special tools are allocated to perform the operations in which tools are shown. The following list of improvised tools is for information only. It is not to be used as a basis for requisition.

b. IMPROVISED TOOLS (figs. 61 and 62).

ADAPTER, hydraulic pump bearing puller

LEGS, hydraulic pump bearing puller

WRENCH, relief valve adjusting

WRENCH, three-stage jack inner plunger, stop ring, and packing nut

WRENCH, three-stage jack intermediate plunger, stop ring, and packing nut

WRENCH, three-stage jack outer plunger, stop ring, and packing nut

Section XIX. MISCELLANEOUS PARTS

65. Scope

Definite instructions cannot be furnished for repairing the parts listed in paragraph 66*d*. They are of armor plate or heavy steel construction and their repair would of necessity be determined by whatever damage each individual part may have sustained and by availability of replacement parts as determined by ORD 7 and 8 and the local supply situation. However, instructions contained in paragraph 66 may prove helpful in repairing damaged parts.

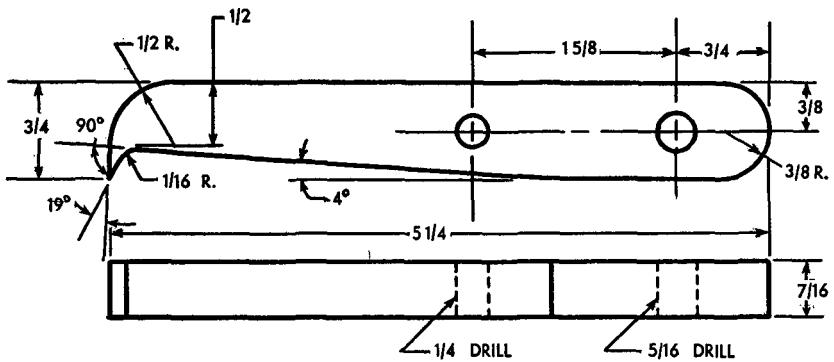

LEGS, HYDRAULIC PUMP BEARING PULLER
2 REQUIRED PER SET

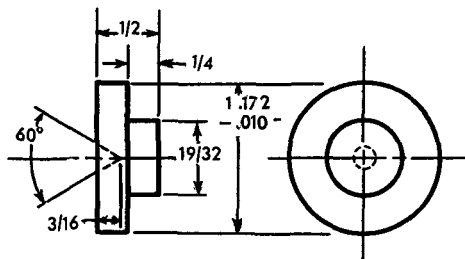

ADAPTER, HYDRAULIC PUMP BEARING PULLER

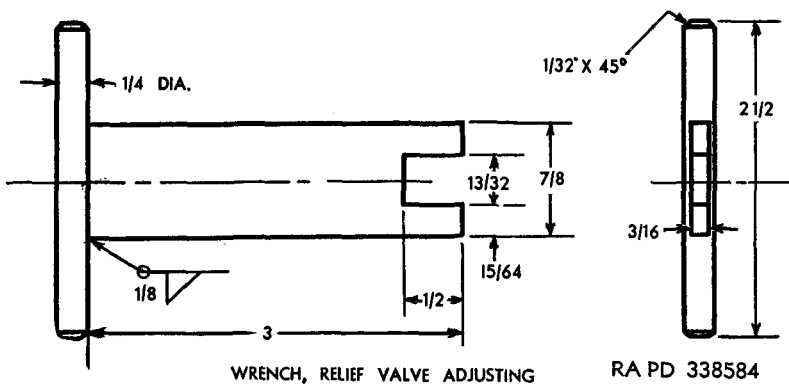

WRENCH, RELIEF VALVE ADJUSTING

RA PD 338584

Figure 61. Improvised tools.

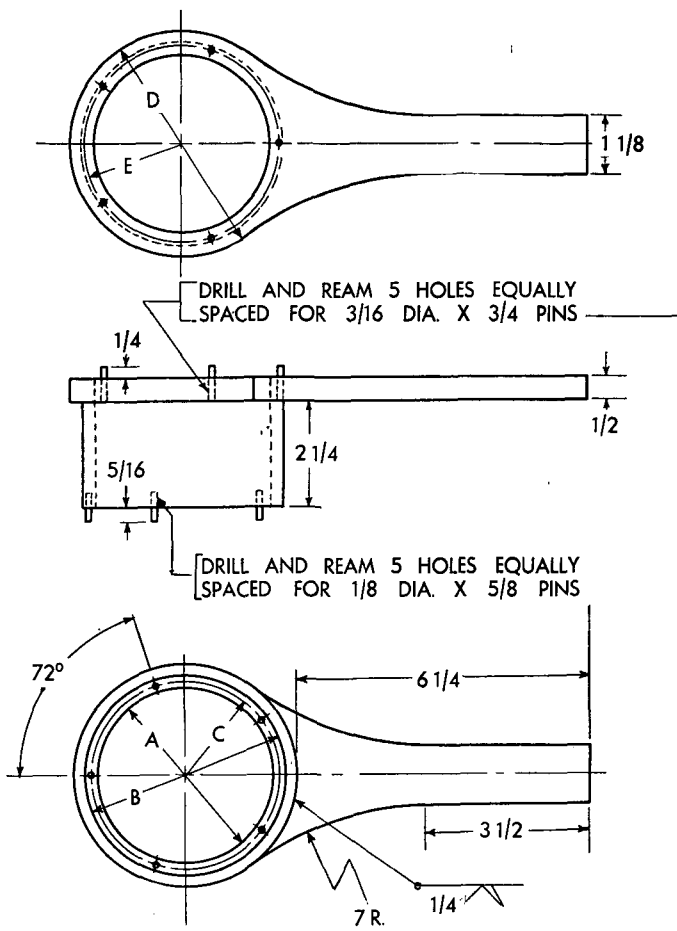

NOMENCLATURE	A DIA.	B DIA.	C RAD.	D DIA.	E RAD.
WRENCH, INNER PLUNGER PACKING NUT AND STOP RING	3.750 +.010	4.250 +.010	2.000	4.750 +.010	2.156
WRENCH, INTERMEDIATE PLUNGER PACKING NUT AND STOP RING	4.750 +.010	5.250 +.010	2.500	5.750 +.010	2.656
WRENCH, OUTER PLUNGER PACKING NUT AND STOP RING	5.750 +.010	6.250 +.010	3.000	6.750 +.010	3.156

RA PD 338585

Figure 62. Improvised tools.

66. Repairs

a. STRAIGHTENING. The use of heat is not recommended when straightening the blade assembly or any of its component parts. Heat weakens structural characteristics of the members and all straightening should be done cold wherever possible. Any parts of the frame assembly, tripod, or mounting brackets which are bent or buckled sufficiently to show strain or cracks after straightening must be reinforced or replaced.

b. REINFORCEMENT. No established rules can be made on the necessity or kind of reinforcements to install when the blade, side-arms, tripod, or mounting brackets have been bent or broken. Reinforcements can be made with channel, angle, or flat stock. Because of the difficulties encountered when inserting channel reinforcements, the use of angle reinforcements is recommended. Wherever possible, the reinforcement should extend over the length of the part that has been straightened. The reinforcement stock used should be of the same tensile strength and thickness as the part that is being reinforced.

c. WELDING. The electric arc-welding method is recommended for all main blade and component welding. Heat generated during welding is localized, and burning of material is minimized whenever this method is used. Additional advantages are that finished welds can be ground, filed, and drilled as necessary. Welding rod must be substantially of the same material as that used in the parts to be welded. For welding methods, refer to TM 9-2852.

d. PARTS.

- Blade bit assemblies
- Blade edge assemblies
- Hydraulic jack support assembly
- Hydraulic oil pump belt guard assembly
- Hydraulic oil pump bracket assembly
- Hydraulic oil reservoir assembly
- Hydraulic pipe guard assemblies
- Jettisoning cable drum assembly
- Jettisoning cable pipe assemblies
- Jettisoning pivot pin arm assembly
- Main frame
- Sheaves
- Tool box assembly
- Track mounting angle support assemblies
- Track mounting (front) block assemblies
- Track mounting bracket assemblies
- Tripod armor assembly
- Tripod assembly

Section XX. HYDRAULIC PUMP

67. Description and Data

a. DESCRIPTION. The hydraulic pump (figs. 63 and 64) is composed of two external spur gears mounted in bearings in a five-piece pump body consisting of the gear housing, two wear plates, and two bearing housings. One of the gears is driven by a drive shaft which is splined to the inside of the gear shaft and keyed to the drive pulley. This shaft is pressed in a bearing which seats in the pump base. The oil enters the gear housing through an intake port and is discharged through an exhaust port by gear action.

b. DATA.

Make ----- LaPlant-Choate
Model ----- P-11

68. Disassembly

a. GENERAL. Clean exterior of pump thoroughly. Place pump on a clean work bench or lay a cloth or cardboard down for the pump parts to be placed on as they are removed from the assembly.

b. REMOVE END PLATE. Remove locking wire and three ¼-inch cap screws securing end plate to shaft end (rear) of pump assembly. Remove end plate (fig. 63).

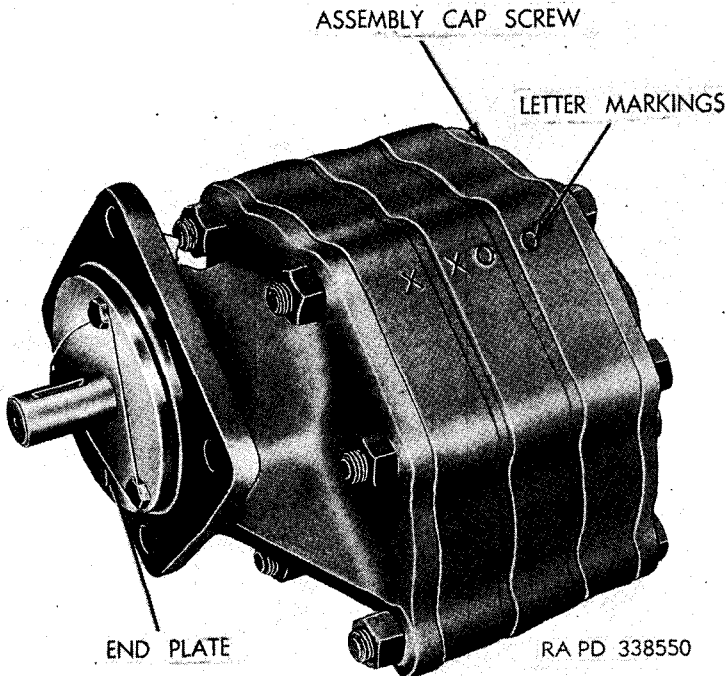

Figure 63. Hydraulic pump—assembled.

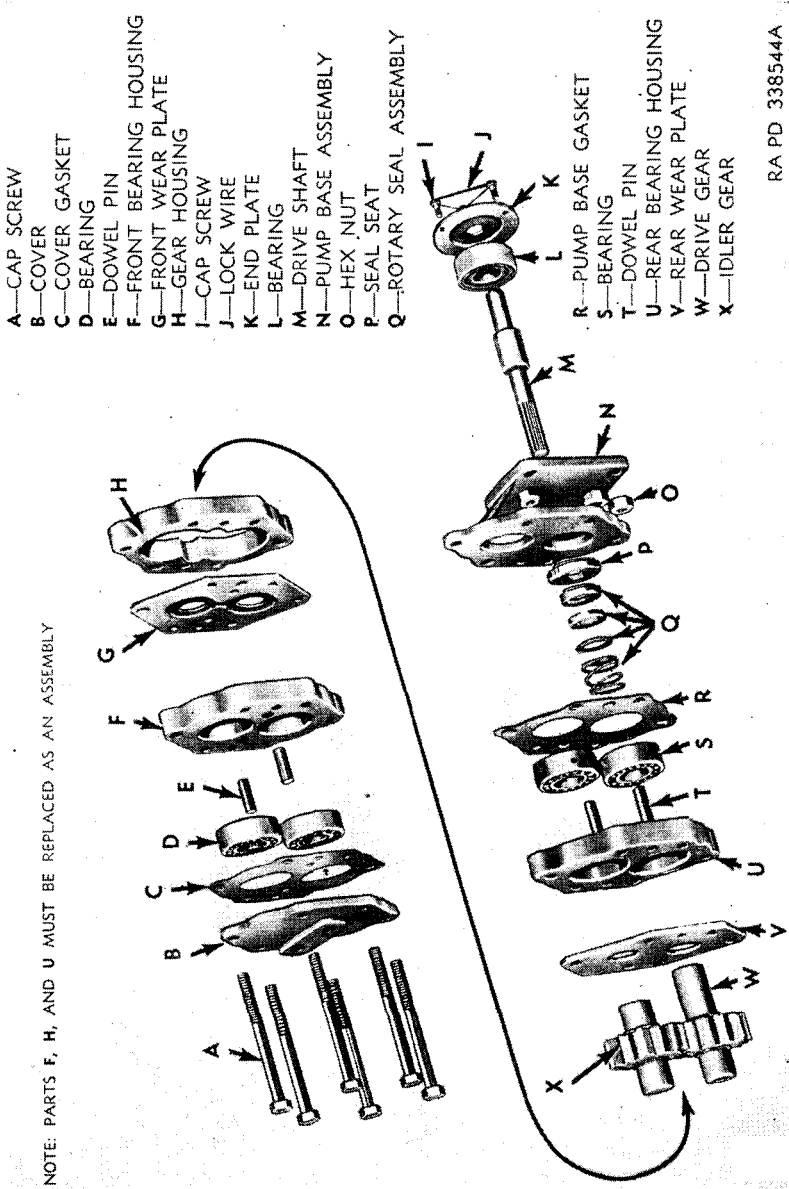

Figure 64. Hydraulic pump—disassembled.

RA PD 338544A

c. **MARK PARTS.** Inspect the bearing housings and gear housing to see that they are properly marked (fig. 63), in order to facilitate their assembly in their correct position. If letter markings are not clear, punch-mark parts.

d. **REMOVE PUMP BASE.** Remove the six pump assembly cap screws (fig. 63) and remove pump base, shaft, and bearing assembly from pump assembly (fig. 65).

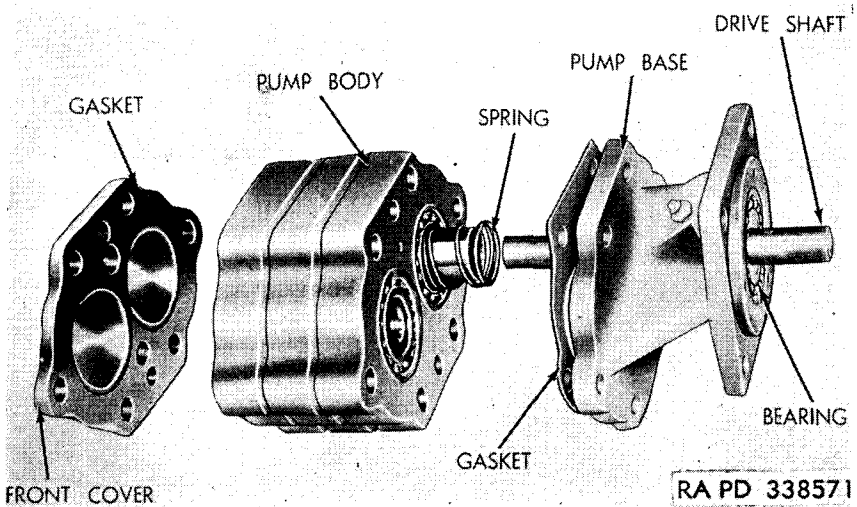

Figure 65. Pump base and front cover separated from pump body.

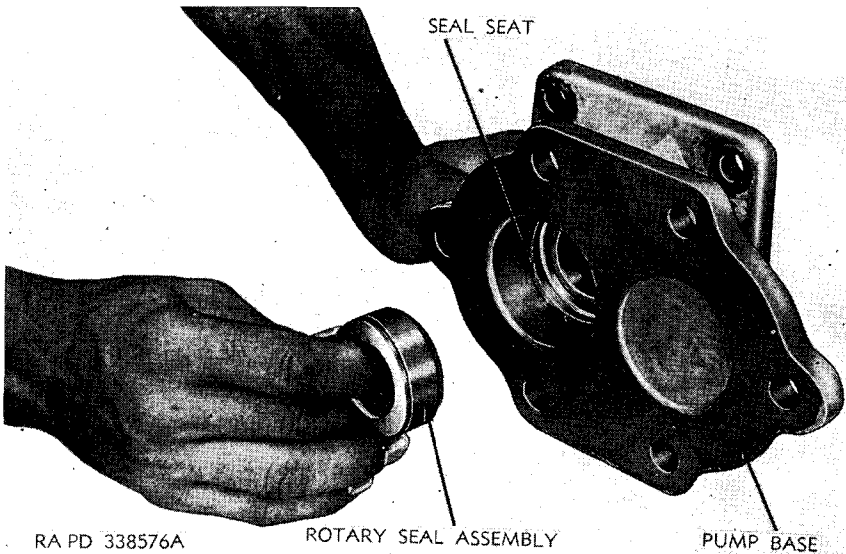

Figure 66. Removing oil seal assembly from pump base.

e. REMOVE DRIVE SHAFT AND BEARING ASSEMBLY. Remove pump drive shaft and end bearing assembly from pump base (fig. 65). Press shaft out of bearing if inspection finds either bearing or shaft defective.

f. REMOVE SEAL ASSEMBLY. Remove spring from drive gear shaft. Remove drive shaft seal assembly from pump base (fig. 66).

g. REMOVE PUMP BODY. Remove pump body and bearing assembly from front end cover (fig. 65).

h. REMOVE BEARING HOUSINGS. Drive the dowel pins out of the housings using a drift punch that will not damage dowel pin holes (fig. 67).

Note. The dowel pins may be removed from either side of the housings as they are line-drilled.

The bearing housings are a light push-fit over the bearings in the assembly; therefore, lift the assembly by holding the bearing housing to be removed. Do not lift the assembly more than a few inches above the work bench as the bearing housing may slip off the bearings at any time, thus dropping the pump. If the housing does not slip off the bearings from the weight of the pump, tap the end of the shafts and bearings lightly with a wood block while supporting the pump by the bearing housing. The housing must

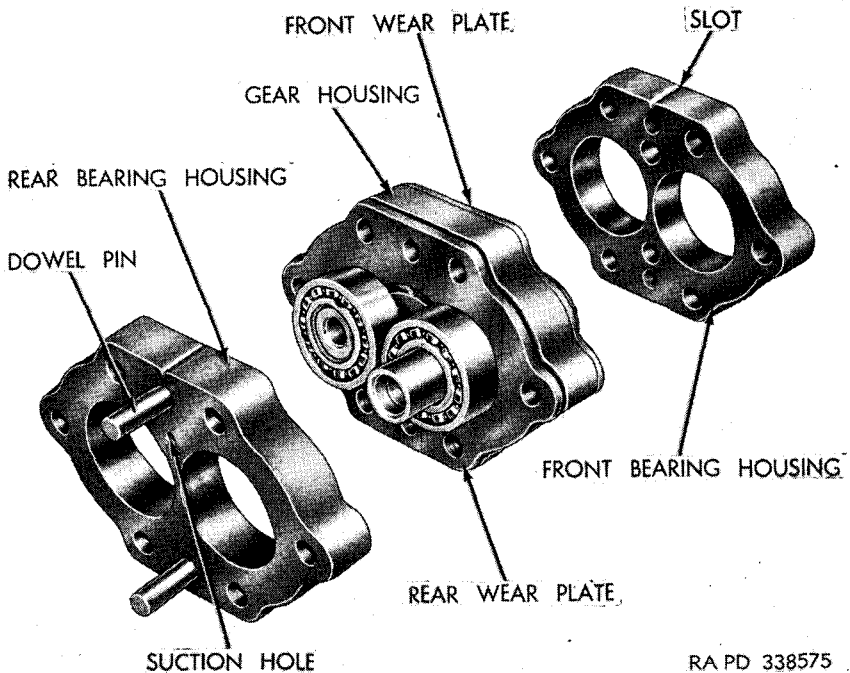

RA PD 338575

Figure 67. Bearing housings removed from pump assembly.

be kept in line with the bearings and removed evenly around the pump to prevent binding.

i. REMOVE BEARINGS.

Caution: Do not attempt to press the shafts out of the bearings, as each shaft and gear is one piece.

Install puller 41-P-2912 with improvised legs (similar but not identical with arrangement shown in figure 68. Puller actually shown is commercial.) over bearing. Tighten setscrew on clamp to force legs in position under bearings. Place improvised adapter under puller screw and remove bearing by turning puller screw clockwise. Remove the other bearing in the same manner.

j. REMOVE WEAR PLATES AND HOUSING. Remove gear wear plates and housing from the gears.

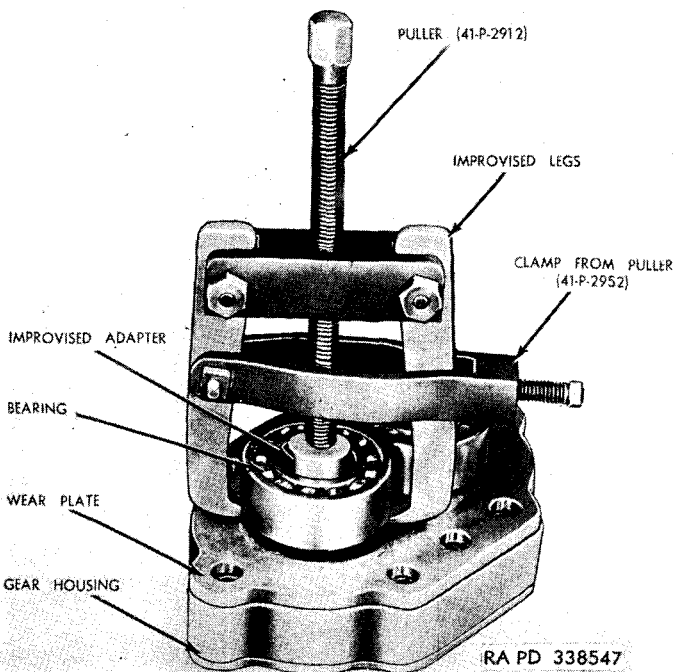

Figure 68. Removing bearing from pump assembly.

69. Cleaning, Inspection, and Repair

a. CLEANING. Wash all parts in dry-cleaning solvent and remove all gasket material or sealing compound that may remain on the housings or wear plates.

b. INSPECTION AND REPAIR. (1) Disassemble the rotary seal assembly as shown in figures 64 and 69 and inspect the seal. Replace the complete seal assembly if the seal is defective.

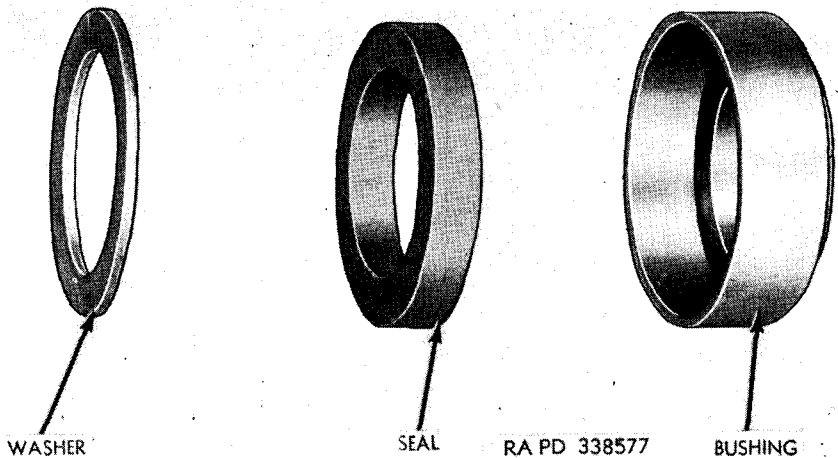

Figure 69. Drive shaft rotary seal.

(2) Examine bearings, shafts and gears, bearing and gear housings, and wear plates for damage or wear.

Note. If the gear housing, either of the bearing housings, or either of the wear plates is damaged or worn, replace both bearing housings, both wear plates, and the gear housing. These parts are line-drilled and fit as an assembly.

When new bearings or bearing housings are to be used, the bearings must be fitted into the housings so that they can be pushed in and out of the housing by hand. If the bearings cannot be pushed in and out of the housing by hand, check for nicks and burrs on the inside of the bearing housing.

70. Assembly

a. GENERAL. Before assembling the pump, make certain that all parts are clean and free from burrs. Place the various parts of the pump on a clean bench in the order in which they are to be assembled (fig. 64).

b. INSTALL REAR WEAR PLATE AND BEARINGS ON GEARS. Place the drive gear and idler gear on the work bench with the drive gear nearest you and with the driving end of the gear shaft pointing up. Apply a light, even film of sealing compound on both sides of the rear wear plate. Place the wear plate over the shafts and gears with the smooth side toward the gears and the small suction hole on the right-hand side of the assembly (fig. 70). Place a bearing over the driving gear shaft and press into position.

Note. The bearing should shoulder on the shaft and not bind the wear plate. If the shaft does not turn freely, support the assembly by the plate and tap the end of the shaft lightly with a wood block or soft hammer to free the plate.

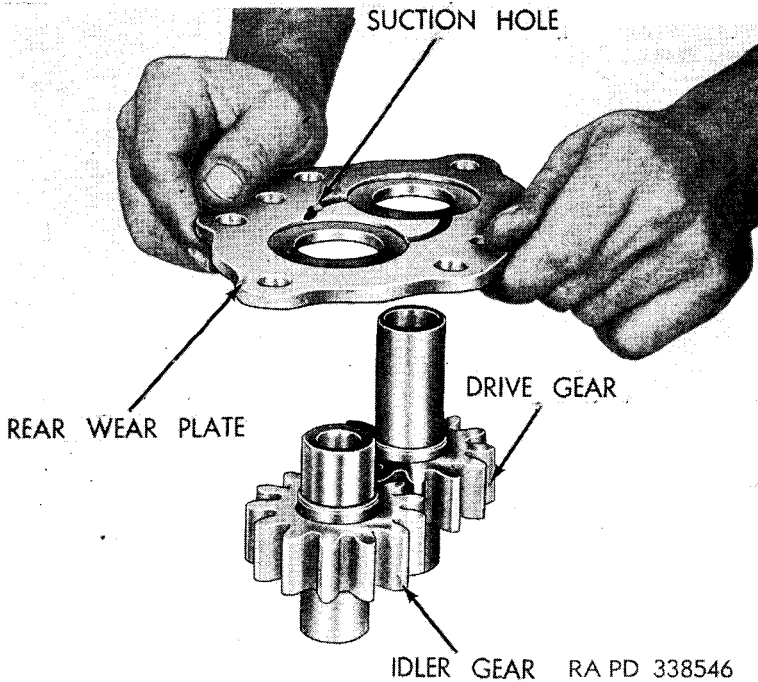

Figure 70. Installing rear wear plate on gears.

Place a bearing over the idler gear shaft and press into position with an arbor press.

c. INSTALL REAR BEARING HOUSING. Place rear bearing housing over the bearings with the small suction hole in the housing in line with the small suction hole in the wear plate (fig. 67). This housing should fit over the bearings with a light push-fit with the hands.

Note. This housing has a letter stamped on it near the edge or face of the housing (fig. 71).

Place housing with letter down or toward gears so that it will match a similar letter on the gear housing to be assembled next.

d. INSTALL GEAR HOUSING. Turn assembly over and place gear housing over the gears with the correct letter matching and lining up with the letter on the rear bearing housing (fig. 71).

Note. The gear housing has two letter markings, one to match the letter on the rear bearing housing and one to match the letter on the front bearing housing.

e. INSTALL FRONT WEAR PLATE AND BEARINGS. Apply a light film of sealing compound on both sides of the front wear plate. Place the wear plate over the shafts with the smooth side toward the gears.

Note. This plate has two holes of the same size, one for the suction and one for the power line, so either may be used for the suction port.

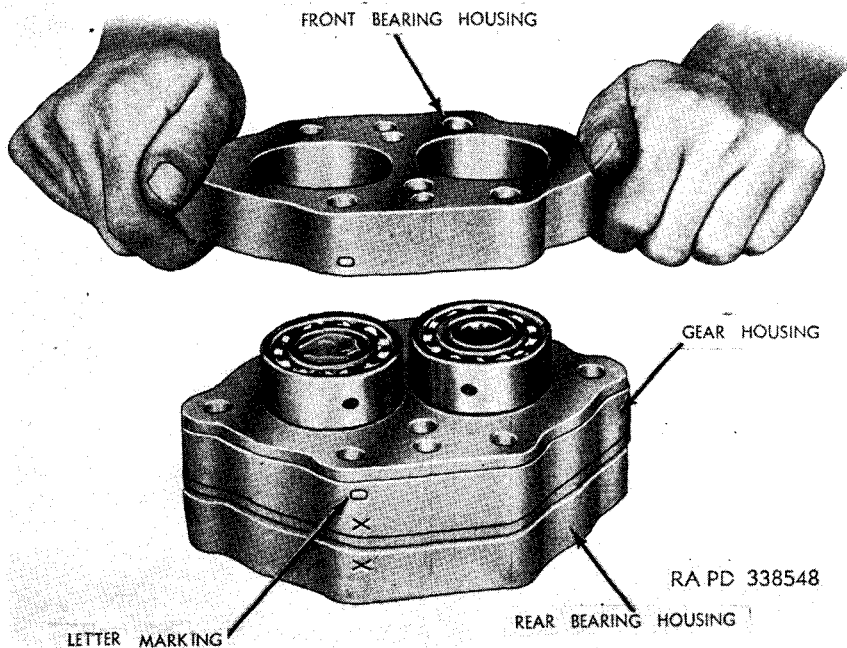

Figure 71. Installing front bearing housing on pump assembly.

Place the bearings over the shafts and press into position. Turn the shafts to see if they are binding after bearings are in position. If the shafts are binding, tap the shaft ends with a wood block or soft hammer.

f. **INSTALL FRONT BEARING HOUSING.** Place the front bearing housing over the bearings with the letter matching a similar letter on the gear housing (fig. 63). This housing should also be a light push-fit with the hands.

g. **INSTALL DOWEL PINS.** Insert dowel pins and drive them into position about one-quarter inch below the face of the bearing housings.

h. **INSTALL FRONT COVER.** Place the front gasket with the two large holes in it over the front bearing housing. Place front cover over gasket.

Note. The cover has one large hole which is the suction port, and which must be placed on the side of the assembly matching the suction side of the rest of the pump.

i. **INSTALL PUMP BASE GASKET.** Insert six assembly cap screws and turn pump over to complete the assembly. Install pump base gasket over cap screws and bearing housing.

j. **INSTALL ROTARY SEAL ASSEMBLY.** Place seal spring over end of drive gear shaft, steel washer over spring, and seal with bushing over washer and spring (fig. 72). Place cup grease on face of seal and seal seat in pump base.

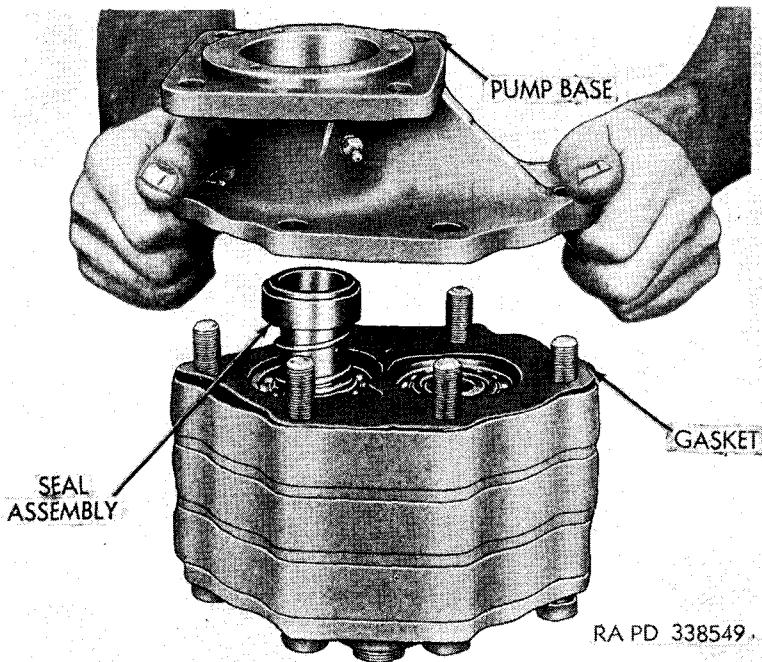

Figure 72. Installing rotary seal assembly and pump base.

k. **INSTALL PUMP BASE.** Place pump base in position over the seal and cap screws, place nuts on the cap screws, and draw the nuts down evenly to prevent damage to the rotary seal assembly.

l. **INSTALL DRIVE SHAFT AND BEARING ASSEMBLY.** If the bearing was removed from the drive shaft, press bearing on drive shaft. Insert drive shaft through pump base, seating the bearing in the base.

m. **INSTALL END PLATE.** Place bearing retaining end plate over shaft and bearing and install three cap screws securely.

Section XXI. CONTROL VALVE

71. Description

The control valve (fig. 73) consists of a body which houses a pressure relief valve and valve (spool) assembly. The relief valve is composed of a cage, plunger, spring, and adjusting nut. A valve cap and gasket are installed over the relief valve for access and adjustment, to keep dirt and foreign matter from entering the valve, and to hold the oil in the valve body when it is in operation. The valve (spool) assembly consists of a valve (spool), spacer, and spring. An oil seal is installed on the valve (spool) in a retainer

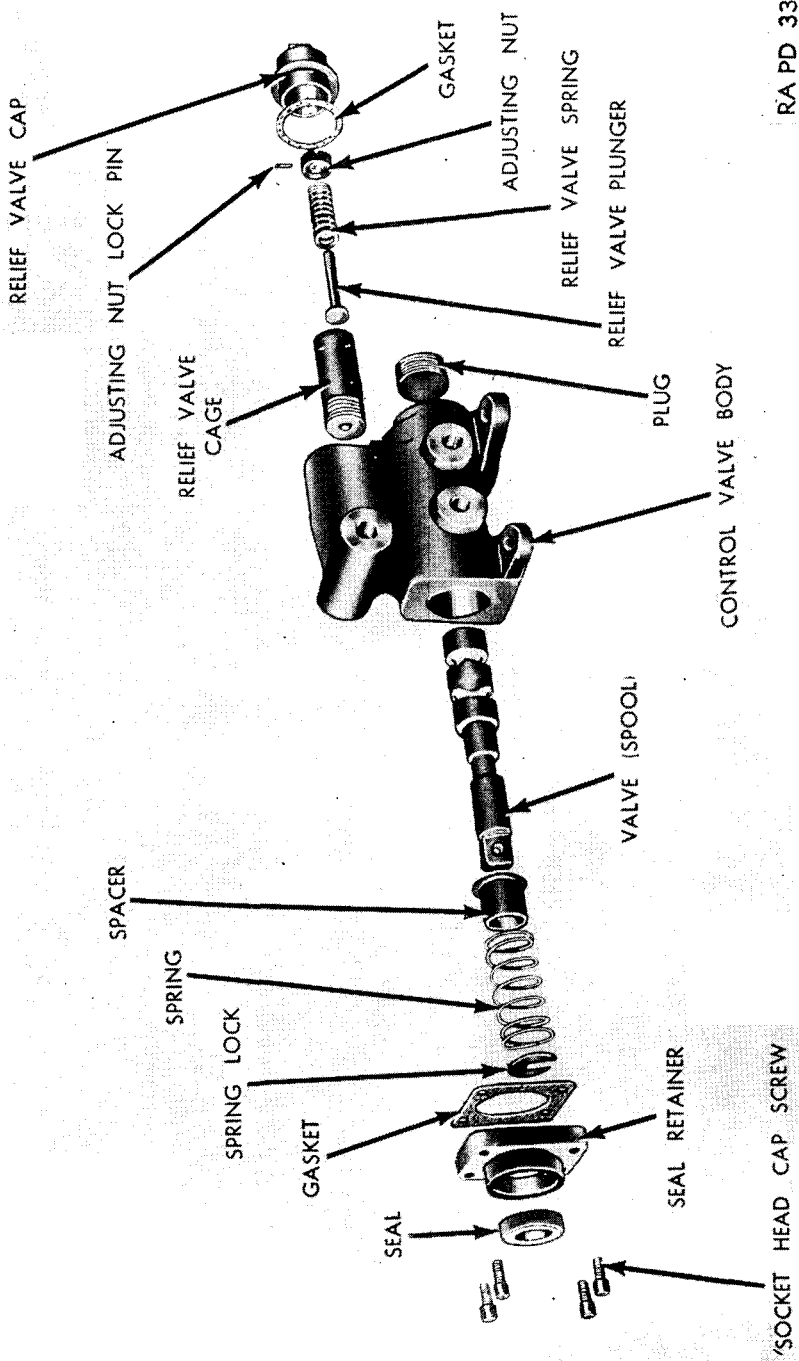

RA PD 338545

Figure 78. Control valve disassembled.

which is secured to the valve body with four socket-head cap screws. This seal prevents oil from leaking out of the valve body.

72. Disassembly

a. GENERAL. Clean exterior of control valve thoroughly. Place valve on a clean work bench or lay down a cloth, cardboard, or paper for the valve parts to be placed on as they are removed from the assembly.

b. REMOVE RELIEF VALVE ASSEMBLY. Remove relief valve cap and gasket from the control valve assembly (fig. 73). Remove lock pin from relief valve assembly with a small screw driver or punch. Remove adjusting nut from inside of relief valve cage by turning nut counterclockwise with improvised wrench (fig. 61) or other suitable tool. Remove relief valve plunger and spring from cage. Remove relief valve cage from control valve assembly, using a light pipe wrench.

c. REMOVE VALVE (SPOOL) ASSEMBLY. Remove the square socket-head plug near pressure relief valve opening (fig. 73). Remove four hexagonal socket-head cap screws and remove oil seal retainer and gasket. Remove valve (spool) assembly from valve body.

73. Cleaning, Inspection, and Repair

a. CLEANING. Wash all parts thoroughly in dry-cleaning solvent and dry with compressed air.

b. INSPECTION AND REPAIR. (1) Examine the seating end of the plunger and its seat in the bottom of cage and if not seating perfectly all around, grind in with valve grinding compound (fine) until it is seating properly.

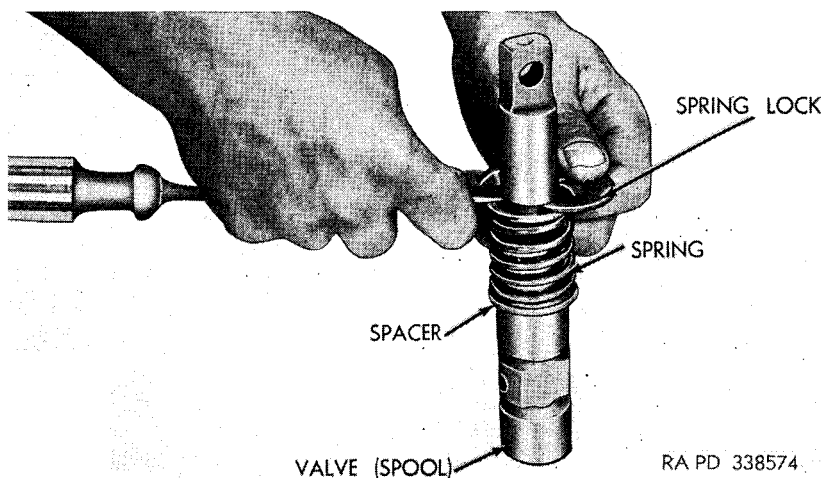

Figure 74. Disassembling valve (spool) assembly.

(2) Examine seal and, if worn or damaged, remove from retainer and replace with new one.

(3) Examine surfaces of valve (spool) and interior of valve body. If either of these parts are scored or worn sufficiently to permit oil to pass by when in "hold" position, replace both parts. Do not attempt to hone the valve body or grind the valve (spool) to remove scratch marks or scorings, as the result will be an undersized valve (spool) or an oversized valve body which will not hold its load.

74. Assembly

a. GENERAL. Inspect parts as they are being assembled to make certain that they are free from abrasives or foreign material of any kind.

b. ASSEMBLE VALVE (SPOOL) ASSEMBLY. Place spacer and spring on valve (spool) and install spring lock as shown in figure 74.

c. INSTALL VALVE (SPOOL) ASSEMBLY. Insert valve (spool) assembly in valve body (fig. 73). Wrap a piece of shim stock around end of valve (spool) and slip oil seal and retainer into position on valve (spool). Secure retainer in position with four hexagonal socket-head cap screws.

d. INSTALL PLUG. Install square socket-head plug in opening near pressure relief valve opening.

e. INSTALL PRESSURE RELIEF VALVE. Install pressure relief valve cage in valve body, using a small pipe wrench. Insert plunger and spring into cage. Install pressure adjusting nut in the approximate position from which removed and lock in place with lock pin. Install relief cap and gasket.

Note. The pressure relief valve should be adjusted to maintain a pressure of 800 pounds per square inch for the bulldozer M1, and 1,000 pounds per square inch for the bulldozer M1A1.

If bench testing equipment is not available, test and adjust pressure relief valve while connected in the tank (par. 56).

Section XXII. HYDRAULIC JACK

75. Hydraulic Jack (Bulldozer M1) (fig. 75)

a. DESCRIPTION. A single-stage hydraulic jack is used on the bulldozer M1. It is composed of a piston assembly, cylinder and base assembly, gland, cylinder head, oil seal, and chevron-type packing. The piston is kept from slipping out of the cylinder by a shoulder on the end of the piston which butts against the gasket and cylinder head in its extended position.

b. DISASSEMBLY. (1) Drain oil from jack.

(2) Remove the three cap screws which secure gland to cylinder head and slip gland and oil seal assembly from piston assembly.

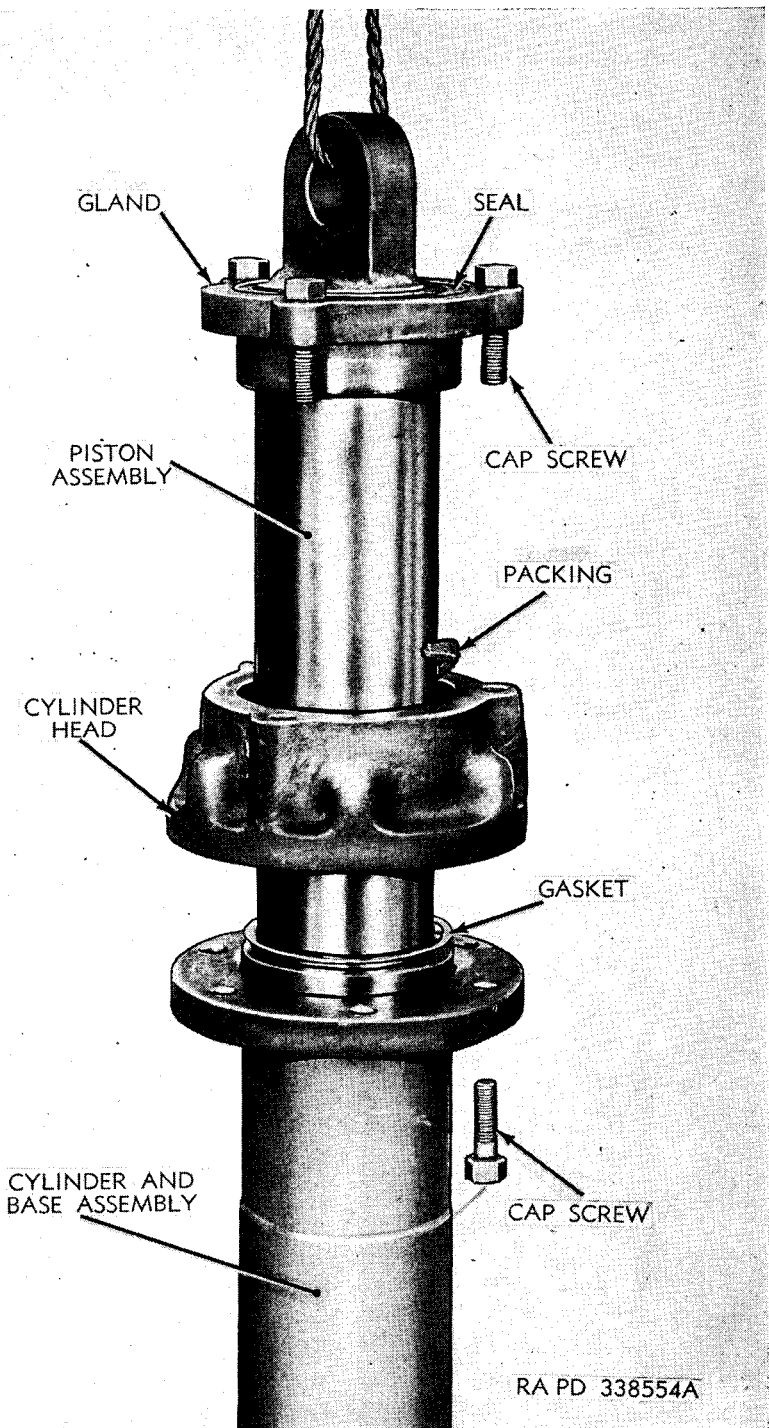

Figure 75. Hydraulic jack assembly—bulldozer M1.

(3) Remove packing from cylinder head, using a packing removing tool.

(4) Remove six cap screws which secure cylinder head to cylinder and base assembly.

(5) Remove cylinder head and gasket from piston assembly.

(6) Remove piston assembly from cylinder and base assembly.

c. CLEANING, INSPECTION, AND REPAIR. (1) *Cleaning.* Clean all parts thoroughly with dry-cleaning solvent and dry with compressed air.

(2) *Inspection and repair.* (a) Inspect seal in gland. Replace seal if damaged or otherwise defective.

(b) Inspect packing. If defective, install new packing at assembly.

(c) Inspect piston assembly for scratches or scores which will allow oil to escape from jack cylinder. Minor scratches or scores may be removed with fine emery cloth. Replace piston assembly if badly scored or damaged.

(d) Inspect gland, head, and cylinder for damage. Replace defective parts at assembly.

d. Assembly. When assembling the jack (fig. 75), keep all parts clean and free from abrasives of any kind.

(1) Lubricate the inside of the cylinder and the piston with light, clean oil, and install piston assembly in cylinder and base assembly.

(2) Place new gasket in position on cylinder shoulder and slip cylinder head into position, making certain that it seats squarely on shoulder. Secure head in position with six cap screws.

(3) Install the chevron-type packing, one ring at a time, keeping the splits in the packing rings opposite each other.

(4) Slip gland and seal assembly in position on piston. After oil has leaked into the packing rings and thoroughly lubricated them, insert three cap screws and draw down on the gland only enough to keep the oil from leaking by the packing gland.

76. Hydraulic Jack (Bulldozer M1A1) (fig. 76)

a. DESCRIPTION. A three-stage hydraulic jack is used on the bulldozer M1A1. It is composed of three main sections—an inner, intermediate, and outer plunger assembly all contained in a cylinder assembly. Each plunger has a stop ring, packing, and packing nut with a wiper ring in it. The stop ring serves as a seat for the packing and also prevents the plunger from being pulled from its respective cylinder.

b. DISASSEMBLY. (1) Drain oil from jack.

(2) Remove inner plunger packing nut from intermediate plunger, using improvised wrench (figs. 62 and 77) or other suitable tool.

(3) Remove two washers, gasket, and packing from around inner plunger, using a packing removing tool.

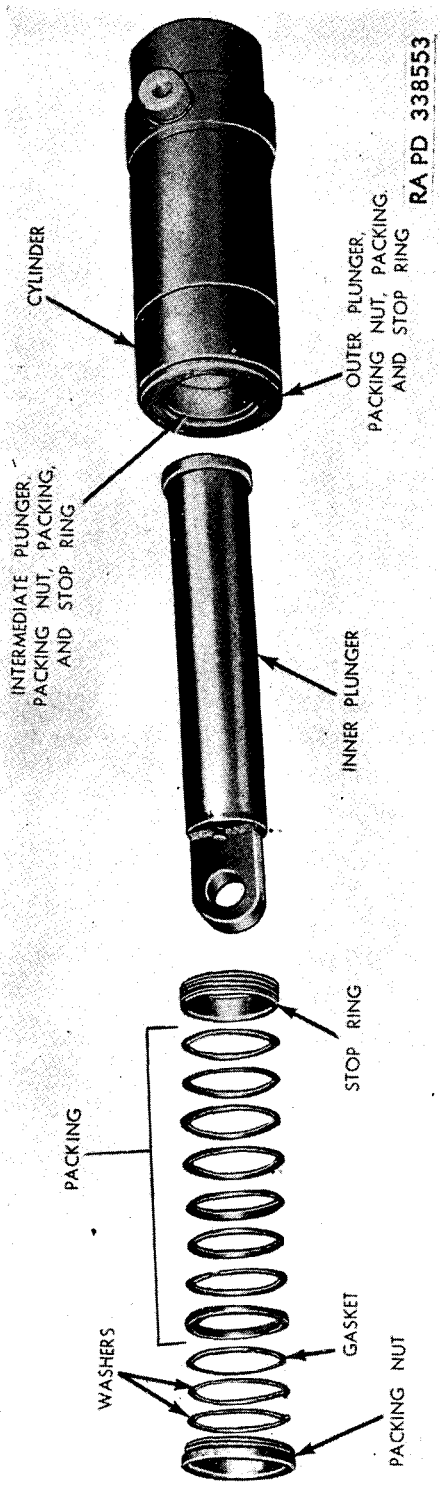

RA PD 338553

Figure 76. Hydraulic jack assembly bulldozer M1A1—with inner plunger assembly—disassembled.

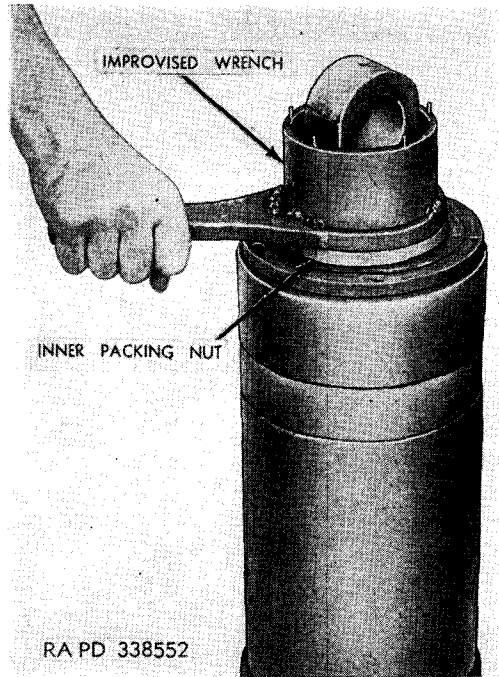

Figure 77. Removing inner plunger packing nut.

(4) Remove inner plunger stop ring, using improvised wrench (figs. 62 and 78) or other suitable tool.

(5) Remove inner plunger from intermediate plunger.

(6) Remove the intermediate and outer plungers following the procedure outlined in (2) through (5) above, using improvised wrenches (fig. 62) or other suitable tools.

c. CLEANING, INSPECTION, AND REPAIR. (1) *Cleaning.* Wash all parts thoroughly in dry-cleaning solvent and dry with compressed air.

(2) *Inspection and repair.* (a) Inspect wiper ring in packing nut. If defective, install new ring.

(b) Inspect packing. If packing is damaged, install new packing at assembly.

(c) Inspect threads on packing nuts, stop rings, and plungers. Remove dirt or foreign material from threads.

(d) Inspect plungers for scratches or scores which will allow oil to escape from jack. Minor scratches or scores may be removed with fine emery cloth.

(e) Inspect air release fitting. Make certain that holes in side of cap and top of fittings are open.

d. ASSEMBLY. (1) Insert inner plunger in intermediate plunger.

(2) Install inner plunger stop ring in intermediate plunger, using

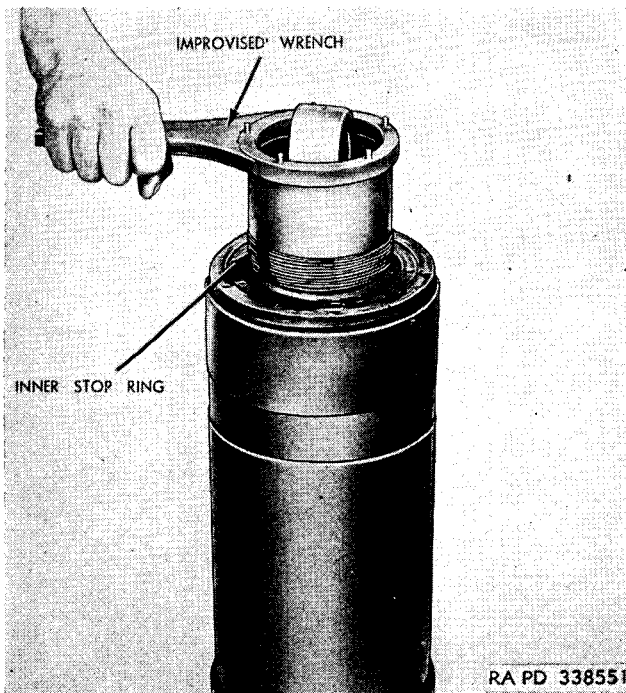

Figure 78. Removing inner plunger stop ring.

improvised wrench (fig. 78) or other suitable tool. Tighten ring securely in plunger.

(3) Insert packing, one ring at a time, pressing each ring in position on its mating ring.

(4) Insert gasket and two washers over packing with the opening in each washer on opposite sides of plunger.

(5) Install inner plunger packing nut and tighten securely, using improvised wrench (fig. 77) or other suitable tool.

(6) Install the other two plungers following the procedure outlined in (1) through (5) above, and using improvised wrenches (fig. 62) or other suitable tools.

Section XXIII. SERVICEABILITY STANDARDS

77. Hydraulic Pump

a. GEAR HOUSING.

<i>Point of measurement</i>	<i>Dimensions of new parts</i>
Gear hole diameter -----	3.0048 to 3.0040 in.
Gear hole length -----	1.004 to 1.003 in.

b. GEARS.

Outside diameter -----	3.000	to 2.999	in.
Length -----	1.000	to 0.999	in.
Backlash -----	0.010	to 0.007	in.

c. GEAR, HOUSING, AND WEAR PLATE ASSEMBLY.

Minimum O.D. clearance between gear and housing -----	0.004	in.	
Clearance between gear and wear plate -----	0.003	to 0.005	in.

d. OPERATING PRESSURE.

1,300 pounds per sq. in. at 1,500 rpm tank engine speed.

APPENDIX I

SHIPMENT AND LIMITED STORAGE

1. General

a. Preparation of the matériel for domestic shipment will be the same as that prescribed for limited storage (matériel out of use for periods not to exceed 90 days).

b. Instructions for limited storage include receiving inspections, preferred storage, preparation of matériel for storage, necessary inspections and servicing to insure safe storage, and methods of removal from storage.

c. Instructions for domestic shipment include preparation of matériel, crating and crating data, and loading matériel in box cars.

2. Instructions for Limited Storage

a. RECEIVING INSPECTIONS.

Note. When matériel is out of use, it may be turned over to ordnance personnel or placed in a limited storage status for periods not to exceed 90 days. Storage of matériel for periods in excess of 90 days will normally be handled by ordnance personnel only.

Immediately upon receipt of the matériel for storage, it must be inspected and serviced as described in section XI.

b. PREFERRED STORAGE. The preferred type of storage is in closed, dry warehouses or sheds.

(1) *Bulldozer mounted on vehicles.* (a) When outdoor storage is necessary, the storage site will be selected and the vehicle arranged as prescribed in AR 850-15, and vehicles covered with tarpaulins. (Refer to SB 9-63 for storage, inspection, and issue of unboxed serviceable motor vehicles and preparation of unserviceable vehicles for storage.)

(b) Prior to storing, lower the blade so that the piston shafts in the hydraulic jack cylinder are withdrawn entirely within the cylinder to protect the polished surface of the shafts from rust.

(2) *Bulldozer removed from vehicles.* (a) When stored out of doors, bulldozer must be covered with tarpaulins. If bulldozer is crated, the storage site will be selected and arranged as prescribed in SB 9-47.

(b) Prior to storing, withdraw the piston shafts completely into the jack cylinders before removing from vehicle, and securely cap or plug the oil outlet holes to prevent any foreign matter from entering the cylinder.

(c) Cap all openings of the hydraulic lines as they are removed, to keep interior clean.

(d) Cap all openings into the control valve and pump after leaving sufficient oil within to eliminate the possibility of rust accumulating on the polished surface of their interiors.

c. PREPARATION.

Note. All matériel received already processed for domestic shipment will not be processed for storage unless the inspections preparatory to or during storage reveal it necessary.

(1) *Cleaning.* The matériel will be disassembled, and all parts of the blade, side bits, cutting edge, mounting brackets, pivot bearings, etc., must be thoroughly cleaned and made free of all foreign matter. Large accumulations of dirt or other matter should first be removed from the parts by scraping or flushing. Grease may be removed with either dry-cleaning solvent or grease cleaning compound mixed with four parts of either kerosene or dry-cleaning solvent (see TM 9-850).

(2) *Painting.* All painted metal surfaces that have become pitted or rusted must be cleaned and repainted where necessary as outlined in TM 9-2851.

(3) *Lubrication.* Lubricate in accordance with section X (fig. 49). Remove all excess grease after lubricating and before applying preservatives.

(4) *Application of preservatives.* Preservatives must be applied immediately after cleaning and drying as a rust stain will form if matériel is handled between operations. Rust-preventive compound (light) and (heavy) used herein must be heated for proper consistency before application. For description of preservatives prescribed herein and methods of application, refer to TM 9-850.

(a) *Exterior surfaces.* Apply a coating of heated rust-preventive compound (heavy) to all unpainted exterior surfaces and the cutting edge and to entire front of the dozer blade.

(b) *Interior surfaces.* Interior surfaces, from which it would be difficult to remove corrosion-preventives, will be given a coating of heated rust-preventive compound (light).

d. *INSPECTIONS.* During storage, a visual inspection must be made periodically to determine general condition. If corrosion is found on any part, remove the rust spots, clean, and treat with the prescribed preservative.

e. *REMOVAL FROM LIMITED STORAGE.* (1) If the matériel is not shipped or issued upon expiration of the limited storage period, the matériel must be further treated for stand-by storage (matériel out of use for periods in excess of 90 days up to 3 years).

(2) Matériel to be shipped will not be deprocessed unless inspection reveals it necessary (par 3a below).

(3) When it has been ascertained that matériel is to be placed

into immediate service, remove all rust-preventive compounds and thoroughly lubricate as prescribed in *c*(1) and (3), above. Matériel then will be thoroughly inspected and serviced as prescribed in section XI.

3. Instructions for Domestic Shipment

a. GENERAL. If matériel to be shipped will reach its destination within the scope of the limited storage period, it need not be reprocessed upon removal from storage unless inspection reveals it necessary.

b. PREPARATION. For the preparation of matériel for domestic shipment, refer to paragraph 2*c* of this appendix.

c. CRATING. (1) Bulldozer will be removed from the vehicle and crated prior to shipping, using the same crate as matériel was received in (refer to SB 9-69). Disassemble all of the hydraulic control items and place in a wood box. Disassemble the remaining large items of the bulldozer as prescribed in paragraph 7. The boxed hydraulic control items, together with the disassembled large groups, will be strapped securely to the bottom of the crate.

(2) If crate is not available, construct as prescribed in TM 9-2854, using the crated data described in *d* below.

d. CRATING DATA. The essential data necessary in the determination of storage space and shipping requirements for two bulldozers complete with equipment is listed below.

Net weight of bulldozers w/equipment (2) -----	14,200 lb.
Tare weight -----	4,800 lb.
Gross weight (2) -----	19,000 lb.
Outside dimensions of crate:	
Length -----	16 ft. 0 in.
Width -----	10 ft. 11 in.
Height -----	5 ft. 11 $\frac{1}{8}$ in.
Cubic displacement -----	1,036 cu. ft.
Ship tons (40 cu ft) -----	25.900

e. LOADING MATÉRIEL IN BOX CARS. For the methods used in loading and bracing matériel in box cars for rail shipment, refer to TM 9-2854.

APPENDIX II REFERENCES

1. Publications Indexes

The following publications indexes should be consulted frequently for latest changes or revisions of references given in this section and for new publications relating to matériel covered in this manual.

- a. Ordnance Supply Catalog Index ----- ORD 2
- b. Ordnance Major Items and Combinations, and
Pertinent Publications ----- SB 9-1
- c. List and Index of Department of the Army
Publications ----- FM 21-6
- d. List of War Department Films, Film Strips, and
Recognition Film Slides ----- FM 21-7
- e. Military Training Aids ----- FM 21-8

2. Standard Nomenclature Lists

a. MAINTENANCE.

- Antifriction Bearings and Related Items ----- ORD 5 SNL H-12
- Cleaners, Preservatives, Lubricants, Recoil
Fluids, Special Oils, and Related
Maintenance Materials ----- ORD 3 SNL K-1
- Elements, Oil Filter ----- ORD 5 SNL K-4
- Items of Soldering, Metallizing, Brazing, and
Welding Materials; Gases and Related Items -- ORD 3 SNL K-2
- Lubricating Equipment, Accessories, and
Related Dispensers ----- ORD (*) SNL K-3
- Miscellaneous Hardware ----- ORD 5 SNL H-2
- Standard Hardware ----- ORD 5 SNL H-1
- Tool-Sets (Common), Specialists'
and Organizational ----- ORD 6 SNL G-27 (Sec. 2)
- Tool-Sets (Special), Motor Vehicles -- ORD 6 SNL G-27 (Sec. 1)
- b. VEHICULAR.
- Bulldozer, M1 and M1A1 ----- ORD (*) SNL G-228

3. Explanatory Publications

a. FUNDAMENTAL PRINCIPLES.

- Basic Maintenance Manual ----- TM 38-650
- Driver Selection, Training and Supervision, Half-
Track and Full-Track Vehicles ----- TM 21-301
- Driver's Manual ----- TM 21-305

(*) See ORD 2, Index, for published pamphlets of the Ordnance section of the Army Supply Catalog.

Instruction Guide: Welding Theory and Application	TM 9-2852
Motor Vehicles	AR 850-15
Precautions in Handling Gasoline	AR 850-20
<i>b. MAINTENANCE AND REPAIR.</i>	
Cleaning, Preserving, Sealing, and Related Materials	
Issued for Ordnance Matériel	TM 9-850
Maintenance and Care of Hand Tools	TM 9-867
Medium Tanks M4 and M4A1	TM 9-731A
Medium Tank M4 (105-mm Howitzer) and Medium Tank M4A1 (76-mm gun)	TM 9-731AA
Medium Tank M4A2	TM 9-731B
Motor Vehicle Inspections and Preventive Maintenance Services	
Ordnance Service in the Field	FM 9-5
Tank, Medium, M4A3	TM 9-759
<i>c. PROTECTION OF MATÉRIEL.</i>	
Camouflage, Basic Principles	FM 5-20
Decontamination	TM 3-220
Decontamination of Armored Force Vehicles	FM 17-59
Defense Against Chemical Attack	FM 21-40
Explosives and Demolitions	FM 5-25
<i>d. STORAGE AND SHIPMENT.</i>	
Instruction Guide, Ordnance Packaging and Shipping (Posts, Camps, and Stations)	
Ordnance Storage and Shipment Chart—Group G— Major Items	SB 9-OSSC-G
Preparation of Ordnance Matériel for Deep Water Fording	
Preparation of Unboxed Ordnance Matériel for Shipment	SB 9-4
Protection of Ordnance Matériel in Open Storage	SB 9-47
Registration of Motor Vehicles	AR 850-10
Reusable Shipping Containers for Tank and Automotive Assemblies: Proper Use and Care	
Rules Governing the Loading of Mechanized and Mo- torized Army Equipment, also Major Caliber Guns, for the United States Army and Navy, on Open Top Equipment, Published by Operations and Mainte- nance Department of Association of American Railroads	SB 9-69
Storage, Inspection, and Issue of Unboxed Serviceable Motor Vehicles; Preparation of Unserviceable Ve- hicles for Storage; and Deprocessing of Matériel Prior to Operation	
The Ordnance Company, Depot	FM 9-25

INDEX

	<i>Paragraph</i>	<i>Page</i>
Assembly of bulldozer -----	8	12
Blade assembly:		
Description -----	42	57
Jettisoning from tank -----	18	42
Maintenance:		
Organizational -----	36	53
Using arm -----	32, 34, 35	49, 51, 52
Removal and installation -----	42	57
Trouble shooting -----	41	57
Blade group, installation -----	12	37
Cleaning -----	App. I	98
Control levers:		
Description -----	17	41
Inspection -----	16	40
Maintenance:		
Organizational -----	36	53
Using arm -----	32, 33, 34, 35	49, 50, 52
Control Valve:		
Assembly -----	74	91
Cleaning and repair -----	73	90
Description:		
Valve -----	71	88
Valve assembly -----	59	71
Disassembly -----	72	90
Inspection -----	16, 73	40, 90
Installation:		
Valve -----	9	12
Valve assembly -----	59	71
Maintenance:		
Organizational -----	36	53
Using arm -----	32, 33, 34, 35	49, 50, 52
Removal of assembly -----	59	71
Controls, description -----	17	41
Crating -----	App. I	98
Cutting edge and bits -----	43	59
Data -----	4	3
Demolition -----	22, 23	43, 44
Description of bulldozer -----	3	3
Difference between models -----	1, 3	1, 3
Forms -----	2	1
Generator:		
Alteration:		
Cradle bracket -----	9	12
Frame -----	9	12
Installation:		
Cradle bracket -----	9	12

	<i>Paragraph</i>	<i>Page</i>
Drive pulley -----	9	12
Generator -----	9	12
Removal:		
Cradle bracket -----	9	12
Drive pulley -----	9	12
Generator -----	9	12
Hydraulic system:		
Description and data -----	55	68
Installation of parts:		
Outside tank -----	10	27
Within tank -----	9	12
Test and adjustment of pressure -----	56	68
Trouble shooting (<i>see also</i> Jack; Pipe lines; <i>and</i> Pump) -----	38	56
Inspection -----	16	40
Jack:		
Assembly, cleaning, and disassembly -----	75	91
Description -----	61, 75, 76	74, 91, 93
Inspection -----	16, 75, 76	40, 91, 93
Installation:		
Jack -----	10, 61	27, 74
Jack box -----	10	27
Supports -----	10	27
Maintenance:		
Organizational -----	36	53
Using arm -----	32, 33, 34, 35	49, 51, 52
Removal -----	61	74
Repair -----	75, 76	91, 93
Jack connecting pin -----	48	63
Pivot arm -----	47	63
Jack support frame -----	50	64
Jack supports -----	53, 54	66
Jettisoning assembly:		
Maintenance:		
Organizational -----	36	53
Using arm -----	33, 34, 35	50, 51, 52
Trouble shooting -----	40	57
Jettisoning cable drum -----	46	61
Jettisoning cables:		
Description -----	17	41
Maintenance:		
Organizational -----	36	53
Using arm -----	33	50
Removal and installation -----	45	60
Jettisoning control lever:		
Inspection -----	16	40
Maintenance:		
Organizational -----	36	53
Using arm -----	33, 34, 35	50, 51, 52
Kit, M14 (T18) periscope -----	13	38
Lubrication:		
Equipment -----	28	48

	<i>Paragraph</i>	<i>Page</i>
Order -----	27	45
Points of application -----	28	48
Special instructions for—		
Extremes of climate -----	21	43
Maintenance -----	35, 36	52, 53
Storage -----	App. I	98
Maintenance:		
After operation -----	35	52
At halt -----	34	51
Battery mechanism -----	36	53
Before operation -----	32	49
Crew -----	31	49
During operation -----	33	50
Monthly and semimonthly -----	36	53
Oil reservoir:		
Alteration of support bracket -----	9	12
Description and cleaning -----	60	71
Inspection -----	16	40
Installation -----	9, 60	12, 71
Maintenance:		
Organizational -----	36	53
Using arm -----	32, 33, 34, 35	49, 50, 51, 52
Removal -----	60	71
Operating instructions -----	5	9
Precautions -----	19	43
Operation:		
Description -----	18	42
Under unusual conditions -----	21	43
Painting -----	App. I	98
Parts:		
Identification of -----	7	10
Miscellaneous -----	65	76
Repairs -----	66	79
Spare -----	25	45
Periscope M14 (T18) -----	13	38
Pipe Guards:		
Description and removal -----	51, 52	65
Installation -----	10, 51, 52	27, 65
Pipe lines:		
Inspection -----	16	40
Installation -----	10	27
Maintenance:		
Organizational -----	36	53
Using arm -----	32, 33, 34, 35	49, 50, 51, 52
Pump:		
Adjustment of drive belt -----	9	12
Alteration of mounting plate and bracket -----	9	12
Assembly -----	70	85
Cleaning -----	69	84
Data -----	57	69
Description -----	57, 67	69, 80
Disassembly -----	68	80

	<i>Paragraph</i>	<i>Page</i>
Installation:		
Drive belt guards -----	9	12
Drive belts -----	58	70
Drive flange -----	9	12
Mounting plate and bracket -----	9	12
Pump assembly -----	57	69
Maintenance:		
Organizational -----	36	53
Using arm -----	32, 33, 34, 35	49, 50, 51, 52
Removal:		
Drive belts and pulley -----	58	70
Pump assembly -----	57	69
Repair -----	69	84
Serviceability standards -----	77	96
Propeller shaft -----	9	12
Records and forms -----	2	1
Repair instructions -----	63	76
Reservoir. (<i>See Oil reservoir.</i>)		
Serviceability standards -----	77	96
Shipment and storage -----	App. I	98
Suspension mounting brackets:		
Description and removal -----	49	63
Installation:		
Horizontal brackets -----	11, 49	33, 63
Vertical brackets -----	11, 49	33, 63
Maintenance -----	36	53
Tachometer drive shaft joint:		
Installation -----	9	12
Removal -----	9	12
Tools:		
Improvised -----	64	76
Special -----	26, 64	45, 76
Transmission input shaft flange -----	9	12
Tripod assembly:		
Description -----	44	59
Inspection -----	16	40
Maintenance:		
Organizational -----	36	53
Using arm -----	32, 33, 34, 35	49, 50, 51, 52
Removal and installation -----	44	59
Trouble shooting -----	39	57
Trouble shooting -----	37	56
Unpacking of bulldozer -----	7	10
Valve. (<i>See Control valve.</i>)		